

Delock Adapter Sub-D 37 Pin Stecker > Terminalblock 39 Pin

Kurzbeschreibung

Über diesen Sub-D zu Terminalblock Adapter von Delock können Litzen mit abisolierten Enden angeschlossen werden. Dadurch ist der Adapter nicht nur für spezielle Industrieanwendungen, z.B. für Service-, Mess - und Prüfzwecke geeignet, sondern kann auch im Hobbybereich, wie dem Eisenbahnmodellbau, angewendet werden.

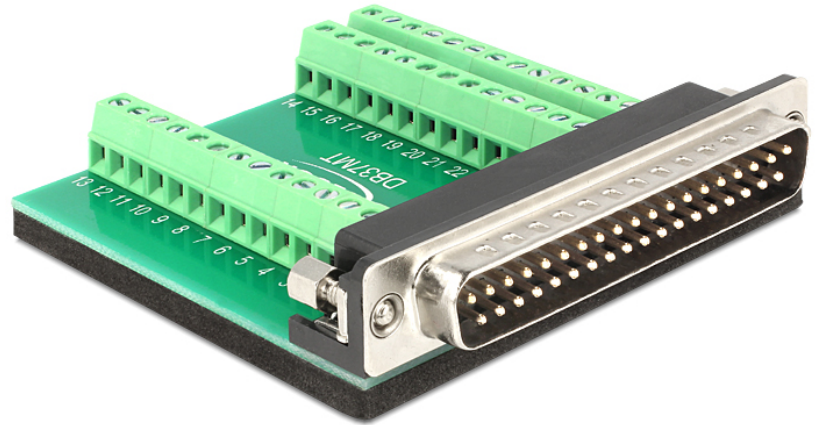

Technische Daten

- Sub-D 37 Pin Stecker
- 3 x 13 Pin Terminalblock (37 Pins beschaltet)
- Pitch 3.81 mm
- Maße (LxBxH): 69,7 mm x 69,32 mm x 16,05 mm

Artikel-Nr. 65320



EAN 4043619653201

Ursprungsland China

Packungsinhalt

- Adapter

Verpackung

- Poly Bag

Delock Adapter Sub-D 37 pin male > Terminal Block 39 pin

Description

This Sub-D to terminal block adapter is made for special industrial application e.g. for connecting single wires with open cable heads. It also can be used in the hobby area for example for model railroading.

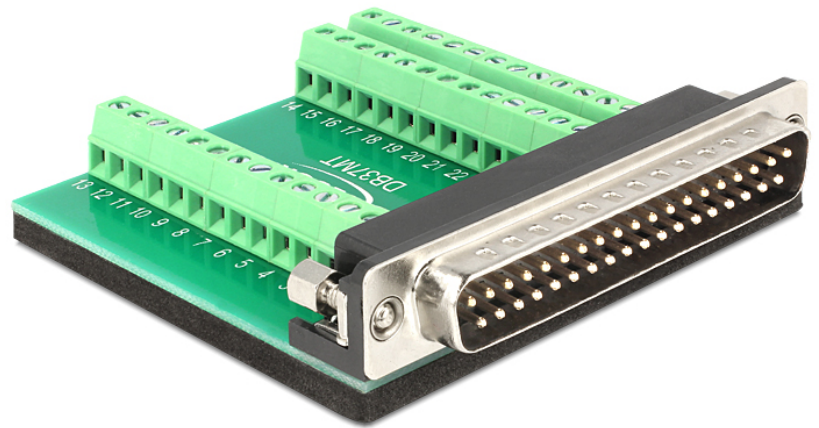

Specification

- Sub-D 37 pin male
- 3 x 13 pin terminal block (37 pins connected)
- Pitch 3.81 mm
- Dimension (LxWxH): 69,7 mm x 69,32 mm x 16,05 mm

Item No. 65320



EAN 4043619653201

Country of origin China

Package content

- Adapter

Package

- Poly bag

WIRING TABLE	
DB37 PIN #	TERMINAL PIN #
1	1
2	2
3	3
4	4
5	5
6	6
.....
.....
.....
32	32
33	33
34	34
35	35
36	36
37	37
SHELL	SHL

REVISIONS			
REV	DESCRIPTION	DATE	APPROVED
A	INITIAL RELEASE	7/11/11	Liu Jian Ping

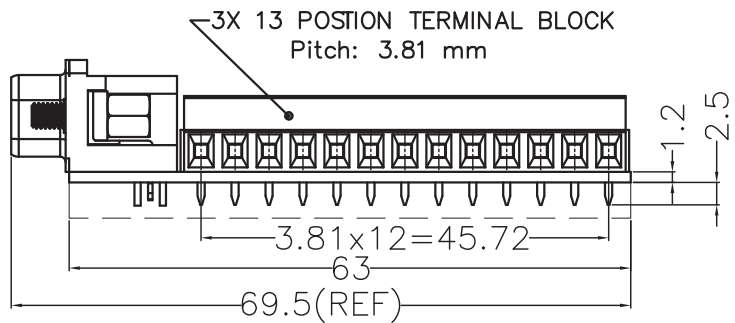
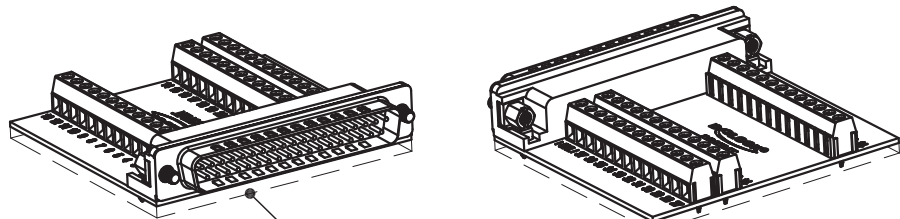
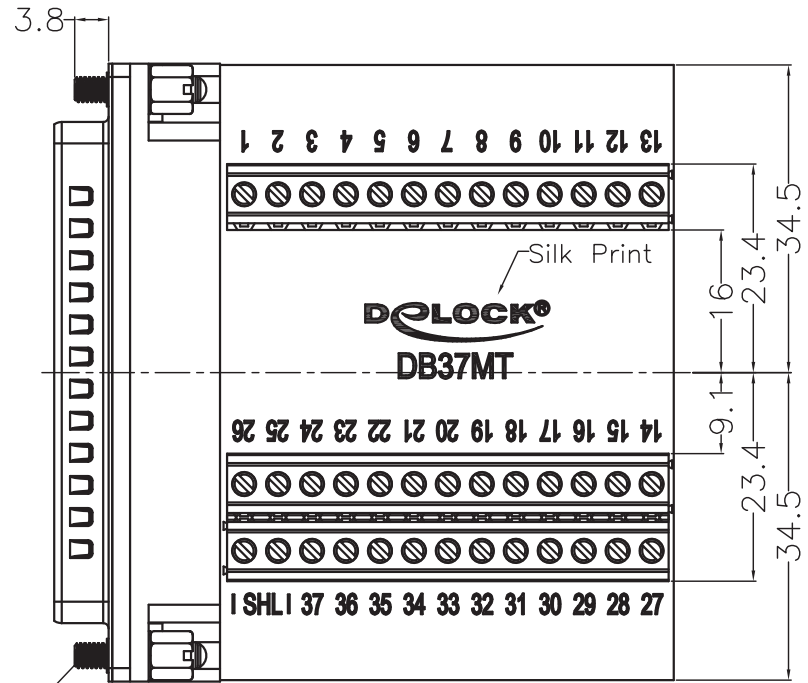
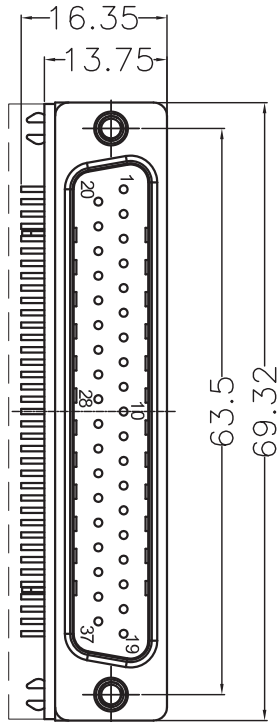
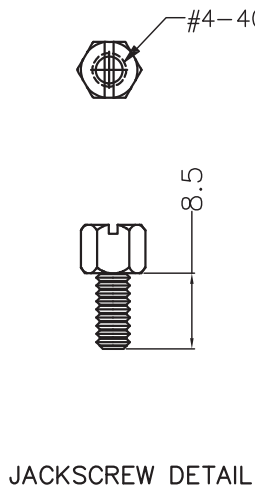

Part name:
Adapter terminal block > Sub-D 37 pin male

Electrical Character:

- 1> 100% open&short testing
- 2> With understanding voltage:DC 500 V 0.01 Sec.
- 3> Insulation Resistance: 50M Ohm (Min)
- 4> Conductive Resistance: 2 Ohm(Max)

UNLESS OTHERWISE SPECIFIED, DIMENSIONS ARE IN mm	APPROVALS	DATE
	DRAWN BY May	1/20/2012
DIMENSIONAL TOLERANCES: .X = ±0.3 .XX = ±0.2 .XXX = ±0.1	CHECKED BY Gang	1/20/2012
	APPROVED BY Steven	1/31/2012
ANGULAR TOLERANCES: ALL = ± 1°	CONFIGURATION DETAILS OF UNDIMENSIONED FEATURES MAY VARY	
PROJECTION	COLOR VARIATIONS MAY OCCUR	

DELOCK®
we move the world

Item no. 65320

Barcode: 4043619653201

File: 88072