



03604-0379

LEVEL 3
1 2 3 4 5



Snowspeeder™

Beiliegenden Sicherheitstext beachten / Please note the enclosed safety advice

- Ⓢ Beiliegenden Sicherheitstext beachten und nachschlagbereit halten.
- Ⓢ Please note the enclosed safety advice and keep safe for later reference.
- Ⓢ Respecter les consignes de sécurité ci-jointes et les conserver à portée de main.
- Ⓢ Houdt u aan de bijgaande veiligheidsinstructies en hou deze steeds bij de hand.
- Ⓢ Seguire le avvertenze di sicurezza allegate e tenerle a portata di mano.
- Ⓢ Observar y siempre tener a disposición este texto de seguridad adjunto.
- Ⓢ Ter em atenção o texto de segurança anexo e guardá-lo para consulta.
- Ⓢ Overhold vedlagte sikkerhedsanvisninger og hav dem liggende i nærheden.
- Ⓢ Ha alltid vedlagt sikkerhetstekst klar til bruk.
- Ⓢ Beakta bifogad säkerhetstext och håll den i beredskap.
- Ⓢ Huomioi ja säilytä oheiset varoitukset.
- Ⓢ Соблюдать технику безопасности, сохранить инструкцию для дальнейших обращений.
- Ⓢ Przestrzegać załączonego tekstu dotyczącego bezpieczeństwa i mieć go zawsze pod ręką.
- Ⓢ Dodržujte tento příložený bezpečnostní text a mějte ho po ruce.
- Ⓢ A mellékelt biztonsági szöveget vegye figyelembe és tartsa fellepozásra készen.
- Ⓢ Respektujte příložený bezpečnostný text a uchovajte ho pre budúce použitie.
- Ⓢ Respectati textul de siguranță atașat și păstrați-l la îndemână.
- Ⓢ Спазвайте приложениа текст за безопасност и го дръжте под ръка за справки.
- Ⓢ Priložena varnostna navodila izvajajte in jih hranite na vsem dostopnem mestu.
- Ⓢ Λάβετε υπόψη σας το συνημμένο κείμενο ασφαλείας και φυλάξτε το ώστε να ανατρέχετε σε αυτό όποτε χρειάζεται.
- Ⓢ Ekteki güvenlik talimatlarını dikkate alıp, bakabileceğiniz bir şekilde muafaza ediniz.

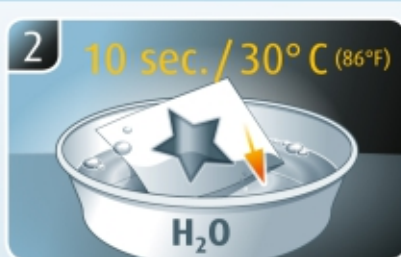
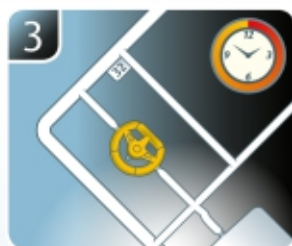
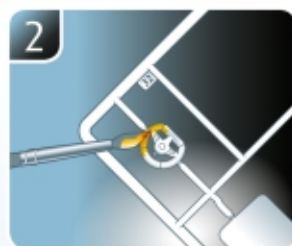
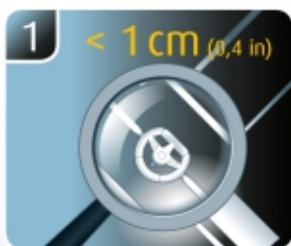
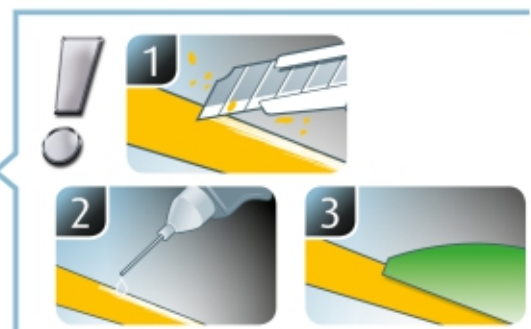
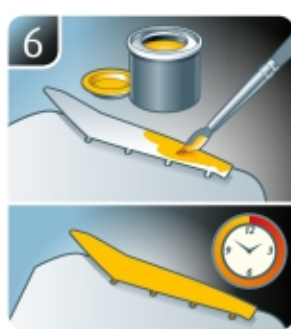
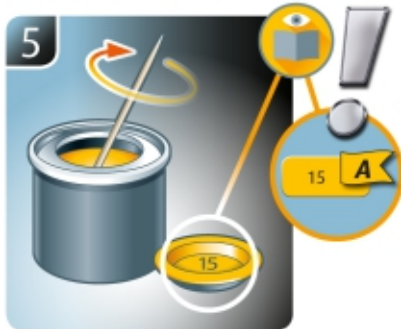
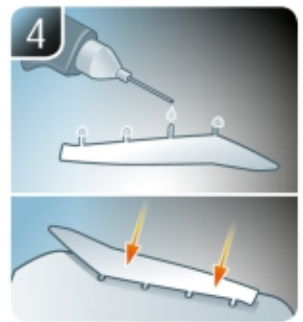
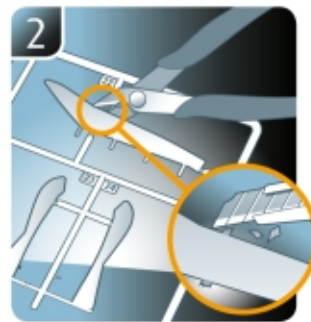
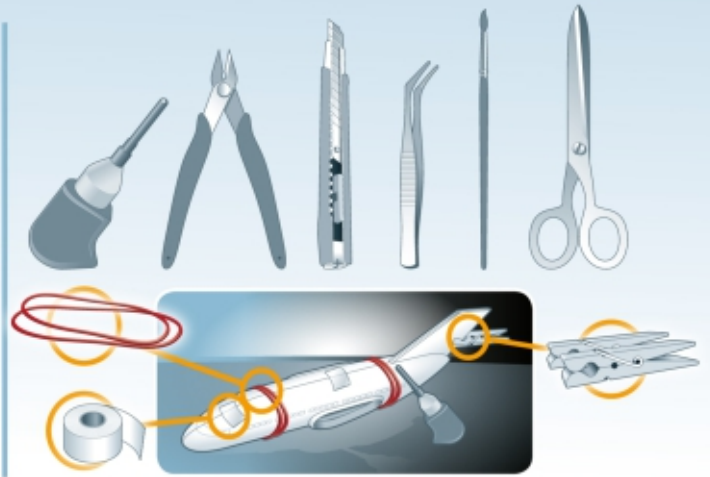

- Ⓜ Weitere Tipps und Tricks.
- Ⓜ Additional tips and tricks.
- Ⓜ Conseils et astuces supplémentaires.
- Ⓜ Andere tips en trucs.
- Ⓜ Ulteriori consigli e suggerimenti.
- Ⓜ Consejos y sugerencias adicionales.
- Ⓜ Mais dicas e truques.

- Ⓜ Flere tips og tricks.
- Ⓜ Flere tips og tricks.
- Ⓜ Ytterligere tips och tricks.
- Ⓜ Lisää vinkkejä ja niksejä.
- Ⓜ Другі поради та хитрості.
- Ⓜ Dalsze wskazówki i sugestie.
- Ⓜ Další tipy a rady.
- Ⓜ További ötletek és fogások.
- Ⓜ Dalsie tipy a triky.
- Ⓜ Alte sfaturi și trucuri.

- Ⓜ Други полезни съвети и трикове.
- Ⓜ Nadaljnji nasveti in zvijače.
- Ⓜ Πρόσθετες συμβουλές και κόλπα.
- Ⓜ Diğer öneriler ve ipuçları.

www.revell.de



- ☑ Kleben
- ☑ Glue
- ☑ Coller
- ☑ Lijmen
- ☑ Incollare
- ☑ Pegamento
- ☑ Colar
- ☑ Lim
- ☑ Lime
- ☑ Limma
- ☑ Liimaa
- ☑ Клеить
- ☑ Przykleić
- ☑ Slepiti
- ☑ Ragassza rá
- ☑ Lepít
- ☑ Lipiti
- ☑ Залепете
- ☑ Prilepite
- ☑ Κολλήστε
- ☑ Yapıştırma



- ☑ Nicht kleben
- ☑ Don't glue
- ☑ Ne pas coller
- ☑ Niet lijmen
- ☑ Non incollare
- ☑ No pegamento
- ☑ Não colar
- ☑ Lim ikke
- ☑ Ikke lime
- ☑ Limma inte
- ☑ Älä liimaa
- ☑ Не клеить
- ☑ Nie przyklejać
- ☑ Nelepiti
- ☑ Ne ragassza rá
- ☑ Nelepít
- ☑ Nu lipiti
- ☑ Не лепете
- ☑ Ne lepite
- ☑ Μην κολλήσετε
- ☑ Yapıştırmayın



- ☑ Bemalen
- ☑ Paint
- ☑ Peindre
- ☑ Beschilderen
- ☑ Colorare
- ☑ Pintar
- ☑ Pintar
- ☑ Mal
- ☑ Male
- ☑ Måla
- ☑ Maalaa
- ☑ Раскрасить
- ☑ Pomalować
- ☑ Pomalovat
- ☑ Fesse be
- ☑ Natriet
- ☑ Vopsiti
- ☑ Боядисайте
- ☑ Pobarvajte
- ☑ Βάψτε
- ☑ Boyama



- ☑ Zusammenbau Reihenfolge.
- ☑ Sequence of assembly.
- ☑ Ordre d'assemblage.
- ☑ Volgorde van montage.
- ☑ Sequenza di assemblaggio.
- ☑ Secuencia de montaje.
- ☑ Sequência de montagem.
- ☑ Samlerækkefølge.
- ☑ Monteringsrekkefølge.
- ☑ Montering ordningsföljd.
- ☑ Kokoamisjärjestys.
- ☑ Последовательность сборки.
- ☑ Kolejność montażu.
- ☑ Pořadí složení.
- ☑ Összerakási sorrend.
- ☑ Poradie zostavenia.
- ☑ Ordinea asamblării.
- ☑ Последовательность на събиране.
- ☑ Vrstni red sestavljanja.
- ☑ Σειρά τοποθέτησης.
- ☑ Parçaları birleştirme sırası.



- ☑ Klarsichtteile
- ☑ Clear parts
- ☑ Pièces transparentes
- ☑ Transparente onderdelen
- ☑ Parti trasparenti
- ☑ Piezas transparentes
- ☑ Peças transparentes
- ☑ Klare dele
- ☑ Klare deler
- ☑ Genomskinliga detaljer
- ☑ Läpinäkyvät osat
- ☑ Прозрачные детали
- ☑ Przezroczyste części
- ☑ Průhledné díly
- ☑ Átlátszó alkatrészek
- ☑ Číre diely
- ☑ Piese transparente
- ☑ Прозрачни части
- ☑ Prozorni deli
- ☑ Διάφανα μέρη
- ☑ Şeffaf parçalar



- ☑ Abziehbild in Wasser einweichen und anbringen.
- ☑ Soak and apply decals.
- ☑ Mouiller et appliquer les décalcomanies.
- ☑ Transfer in water even laten weken en aanbrengen.
- ☑ Immergere la decalcomania nell'acqua e applicarla.
- ☑ Mojar y aplicar calcomanías.
- ☑ Amolecer o decalque em água e aplicar.
- ☑ Gör överföringsbilledet vådt og sæt det på.
- ☑ Myk opp avtrekingsbildet i vann og sett på.
- ☑ Blötlägg dekalen i vatten och sätt på den.
- ☑ Pehmitä siirtokuva vedessä ja siirrä paikalleen.
- ☑ Опустите переводную картинку в воду и нанесите её.
- ☑ Namoczyć kalkomanię w wodzie i przykleić.
- ☑ Nechte obtisk odmočit ve vodě a přilepte.
- ☑ Merítse vízbe és helyezze fel a matricát.
- ☑ Odtlačkový obrázok namočte do vody a priložte na plochu.
- ☑ Inmuiaji abtbildul in apă și aplicați-l.
- ☑ Потопете ваденката във вода и я поставете.
- ☑ Prelepnicu namakajte v vodi. In namestite
- ☑ Μουσκεψτε σε νερό και τοποθετήστε τις χαλκομανίες.
- ☑ Çıkartmayı suda yumuşatın ve takın.



- ☑ Zur Anbringung der Klarteile empfohlen.
- ☑ Recommended to fix clear parts.
- ☑ Recommandé pour fixer les pièces transparentes.
- ☑ Aanbevolen voor het aanbrengen van transparante delen.
- ☑ Raccomandato per l'applicazione delle parti trasparenti.
- ☑ Recomendado para fijar las piezas transparentes.
- ☑ Recomendado para a aplicação das peças transparentes.
- ☑ Anbefales til anbringelse af de klare dele.
- ☑ Anbefales til å feste klare deler.
- ☑ Rekommenderad för montering av de genomskinliga detaljerna.
- ☑ Suositellaan läpinäkyvien osien siirtämiseen.
- ☑ Рекомендуется для крепления прозрачных деталей.
- ☑ Zalecane do przyklejenia przezroczystych części.
- ☑ Doporučujeme k umístění průhledných dílů.
- ☑ Az átlátszó darabok felhelyezéséhez ajánlható.
- ☑ Odporúča sa pre umiestnenie čírych dielov.
- ☑ Recomandat pentru aplicarea pieselor transparente.
- ☑ Препоръчва се за поставяне на прозрачни части.
- ☑ Pri nameščenju prozornih delov priporočamo.
- ☑ Συνιστάται για την τοποθέτηση των διάφανων μερών.
- ☑ Şeffaf parçaların takılması için önerilir.



- ☑ Zur Anbringung der Abziehbilder empfohlen.
- ☑ Recommended for affixing the decals.
- ☑ Recommandé pour l'application des décalcomanies.
- ☑ Aanbevolen voor het aanbrengen van de transfers.
- ☑ Raccomandato per l'applicazione delle decalcomanie.
- ☑ Recomendado para fijar bien las calcomanías.
- ☑ Recomendado para a fixação dos autocolantes.
- ☑ Anbefales til anbringelse af overføringsbillederne.
- ☑ Anbefales til å feste avtrekksbilder.
- ☑ Rekommenderad för montering av klisterdekalerna.
- ☑ Suositellaan siirtokuvien siirtämiseen.
- ☑ Рекомендуется для нанесения переводных картинок.
- ☑ Zalecane do przyklejenia kalkomanii.
- ☑ Doporučujeme k umístění obtiskovacích obrázků.
- ☑ A matrica felhelyezéséhez ajánlható.
- ☑ Odporúča sa pre umiestnenie odtlačkového obrázku.
- ☑ Recomandat pentru aplicarea abtbildurilor.
- ☑ Препоръчва се за поставяне на ваденки.
- ☑ Pri nameščenju nalepnicne priporočamo.
- ☑ Συνιστάται για την τοποθέτηση των χαλκομανιών.
- ☑ Çıkartmaların takılması için önerilir.

- * ☑ Nicht enthalten
- ☑ Not included
- ☑ Non foumi
- ☑ Behoort niet tot de levering
- ☑ Non incluso

- ☑ No incluido
- ☑ Não incluido
- ☑ Medfølger ikke
- ☑ Ikke inkludert
- ☑ Ingår ej
- ☑ Ei sisällä

- ☑ He содержится
- ☑ Nie wchodzi w zakres dostawy
- ☑ Není obsaženo
- ☑ Nem tartalmazza
- ☑ Neobsahuje

- ☑ Nu este inclus
- ☑ He se uključva v komplekta
- ☑ Ni priloženo
- ☑ Δεν περιλαμβάνεται
- ☑ İçermiyor

Benötigte Farben / Required colours

- Ⓢ Peintures nécessaires
- Ⓢ Benodigde kleuren
- Ⓢ Colori necessari
- Ⓢ Cores necesarias
- Ⓢ Cores necessárias
- Ⓢ Nødvendige farver
- Ⓢ Nødvendige farger
- Ⓢ Erforderliga färger
- Ⓢ Tarvittavat värit
- Ⓢ Необходимые краски
- Ⓢ Potrzebne kolory
- Ⓢ Potřebné barvy
- Ⓢ Szükséges színek
- Ⓢ Požadované farby
- Ⓢ Colori necesare
- Ⓢ Необходими цветове
- Ⓢ Potrebne barve
- Ⓢ Απαιτούμενα χρώματα
- Ⓢ Gerekti renkler

30

D

- Ⓢ Orange glänzend
- Ⓢ Orange gloss
- Ⓢ Orange brillant
- Ⓢ Oranje glanzend
- Ⓢ Arancio lucido
- Ⓢ Naranja brillante
- Ⓢ Laranja brilhante
- Ⓢ Orange blank
- Ⓢ Oransje glansende
- Ⓢ Orange blank
- Ⓢ Oranssi kiiltävä
- Ⓢ Оранжевый гляцевый
- Ⓢ Pomarańczowy błyszczący
- Ⓢ Oranžová lesklý
- Ⓢ Narancs, fénytelen
- Ⓢ Oranžová lesklý
- Ⓢ Oranj strălucitor
- Ⓢ Оранжево гланцово
- Ⓢ Oranžna sijoča
- Ⓢ Πορτοκαλί γυαλιστερό
- Ⓢ Turuncu parlak

05

E

- Ⓢ Weiß matt
- Ⓢ White matt
- Ⓢ Blanc mat
- Ⓢ Wit mat
- Ⓢ Bianco opaco
- Ⓢ Blanco mate
- Ⓢ Branco mate
- Ⓢ Hvid mat
- Ⓢ Hvit matt
- Ⓢ Vit matt
- Ⓢ Valkoinen matta
- Ⓢ Белый матовый
- Ⓢ Biały matowy
- Ⓢ Bílá matný
- Ⓢ Fehér, fénytelen
- Ⓢ Biela matný
- Ⓢ Alb mat
- Ⓢ Бяло матово
- Ⓢ Bela mat
- Ⓢ Ασπρο ματ
- Ⓢ Beyaz mat

42

A

- Ⓢ Gelboliv matt
- Ⓢ Olive yellow matt
- Ⓢ Olive jaunâtre mat
- Ⓢ Geelolijf mat
- Ⓢ Oliva giallastro opaco
- Ⓢ Amarello oliva mate
- Ⓢ Amarelo azeitona mate
- Ⓢ Olivengul mat
- Ⓢ Gul oliven matt
- Ⓢ Olivgul matt
- Ⓢ Kellertävä oliivi matta
- Ⓢ Оливково-желтый матовый
- Ⓢ Oliwkowożółty matowy
- Ⓢ Žlutá olivová matný
- Ⓢ Olajsárga, fénytelen
- Ⓢ Olivovo žltá matný
- Ⓢ Galben măsliniu mat
- Ⓢ Жълтеникавомаслинено матово
- Ⓢ Rumeno-olivna mat
- Ⓢ Λαδί κτρινωτό ματ
- Ⓢ Zeytin sarısı mat

75

F

- Ⓢ Steingrau matt
- Ⓢ Stone grey matt
- Ⓢ Gris pierre mat
- Ⓢ Steengrijs mat
- Ⓢ Grigio pietra opaco
- Ⓢ Gris piedra mate
- Ⓢ Cinza pedra mate
- Ⓢ Stengrá mat
- Ⓢ Stengrá matt
- Ⓢ Stengrá matt
- Ⓢ Kivenharmaa matta
- Ⓢ Серый камень матовый
- Ⓢ Kamiennoszary matowy
- Ⓢ Kamenná šedá matný
- Ⓢ Kőszürke, fénytelen
- Ⓢ Kamenná sivá matný
- Ⓢ Gri stâncos mat
- Ⓢ Каменносиво матово
- Ⓢ Kameno-siva mat
- Ⓢ Γκρι-πέλεκ ματ
- Ⓢ Taş grisi mat

06

B

- Ⓢ Teerschwarz matt
- Ⓢ Tar black matt
- Ⓢ Noir goudron mat
- Ⓢ Teerzwart mat
- Ⓢ Nero catrame opaco
- Ⓢ Negro breia mate
- Ⓢ Preto alcatrão mate
- Ⓢ Tjæresort mat
- Ⓢ Tjæresort matt
- Ⓢ Tjærsvart matt
- Ⓢ Tervanmusta matta
- Ⓢ Битумно-чёрный матовый
- Ⓢ Czarna smoła matowy
- Ⓢ Dehtová černá matný
- Ⓢ Kátrányfekete, fénytelen
- Ⓢ Cierna térová matný
- Ⓢ Negru-inchis mat
- Ⓢ Катранено черно матово
- Ⓢ Katransko-črna mat
- Ⓢ Μαύρο βαθύ ματ
- Ⓢ Katran siyahı mat

35

C

- Ⓢ Hautfarbe matt
- Ⓢ Flesh matt
- Ⓢ Couleur chair mate
- Ⓢ Huidkleur mat
- Ⓢ Color pelle opaco
- Ⓢ Carne mate
- Ⓢ Cor da pele mate
- Ⓢ Hudfarvet mat
- Ⓢ Hudfarge matt
- Ⓢ Hudfärg matt
- Ⓢ Ihonväri matta
- Ⓢ Телесный матовый
- Ⓢ Cielisty matowy
- Ⓢ Kůže matný
- Ⓢ Bőrszín, fénytelen
- Ⓢ Plefová matný
- Ⓢ Culoarea pielii mat
- Ⓢ Телесен цвят матово
- Ⓢ Kožne-barve mat
- Ⓢ Χρώμα δέρματος ματ
- Ⓢ Ten rengi mat

70%

05

G

43

30%

- Ⓢ Weiß matt
 - Ⓢ White matt
 - Ⓢ Blanc mat
 - Ⓢ Wit mat
 - Ⓢ Bianco opaco
 - Ⓢ Blanco mate
 - Ⓢ Branco mate
 - Ⓢ Hvid mat
 - Ⓢ Hvit matt
 - Ⓢ Vit matt
 - Ⓢ Valkoinen matta
 - Ⓢ Белый матовый
 - Ⓢ Biały matowy
 - Ⓢ Bílá matný
 - Ⓢ Fehér, fénytelen
 - Ⓢ Biela matný
 - Ⓢ Alb mat
 - Ⓢ Бяло матово
 - Ⓢ Bela mat
 - Ⓢ Ασπρο ματ
 - Ⓢ Beyaz mat
- +
- Ⓢ Mittelgrau matt
 - Ⓢ Medium grey matt
 - Ⓢ Gris moyen mat
 - Ⓢ Mediumgrijs mat
 - Ⓢ Grigio medio opaco
 - Ⓢ Gris medio mate
 - Ⓢ Cinzento médio mate
 - Ⓢ Mellemgrå mat
 - Ⓢ Medium grå matt
 - Ⓢ Mellangrá matt
 - Ⓢ Keskiharmaa matta
 - Ⓢ Средний серый матовый
 - Ⓢ Szary błękitny matowy
 - Ⓢ Středně šedá matný
 - Ⓢ Középszürke, fénytelen
 - Ⓢ Stredne sivá matný
 - Ⓢ Gri mediu mat
 - Ⓢ Средносиво матово
 - Ⓢ Srednje-siva mat
 - Ⓢ Ασπρο ματ
 - Ⓢ Gri mat



- Ⓢ Beispiel: mischen
- Ⓢ Example: mixing
- Ⓢ Exemple: mélange
- Ⓢ Voorbeeld: mengen
- Ⓢ Esempio: mescolare
- Ⓢ Ejemplo: mezclar
- Ⓢ Exemplo: misturar
- Ⓢ Eksempel: blanding
- Ⓢ Eksempel: blanding
- Ⓢ Exempel: blanda
- Ⓢ Esimerkki: sekoittaminen
- Ⓢ Пример: смешивание
- Ⓢ Przykład: mieszać
- Ⓢ Příklad: míchat
- Ⓢ Példa: keverés
- Ⓢ Příklad: miešanie
- Ⓢ Exempu: amestecare
- Ⓢ Пример: смешване
- Ⓢ Primer: mešanje
- Ⓢ Παράδειγμα:

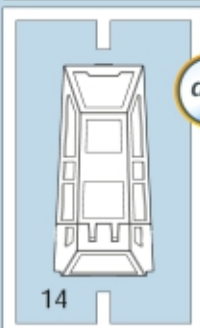
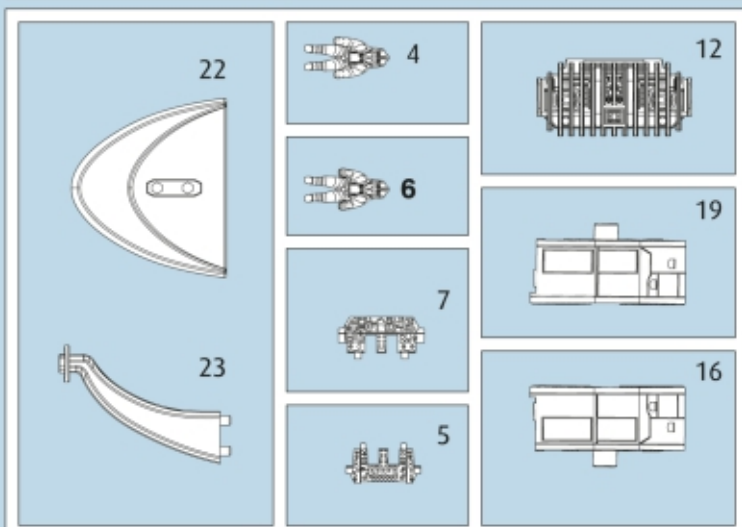
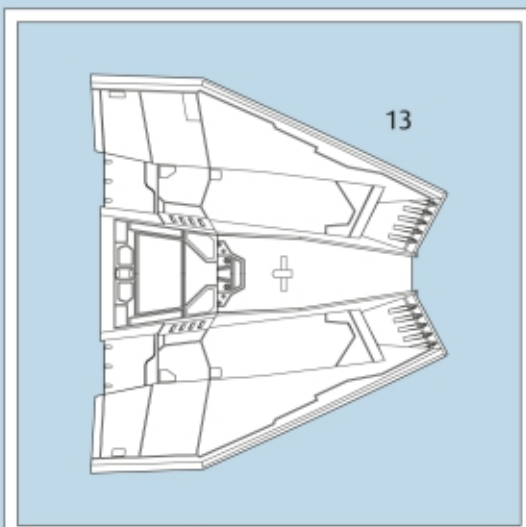
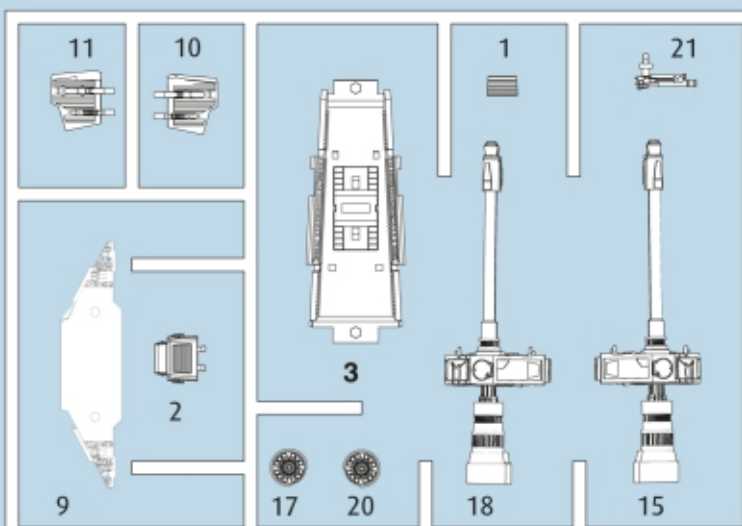
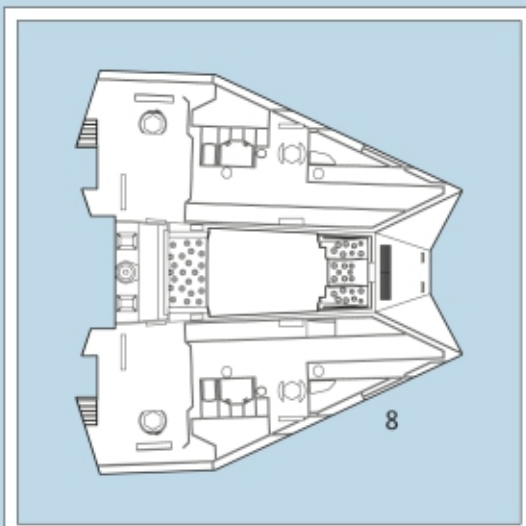

Ersatzteile benötigt?

Kein Problem. Einfach den Revell-Service mit Angabe von Artikel- und Teilenummer kontaktieren. Entweder unter service@revell.de oder Revell GmbH, Abteilung X, Henschelstr. 20-30, 32257 Bünde.*

*Wir bitten um Verständnis, dass eine Gewährleistung nur bei aktuellen Artikeln, die im Zeitraum der letzten 24 Monate erworben wurden, übernommen werden kann. Mit der Ersatzteil-Bestellung können Kosten z.B. für Verpackung und Versand entstehen. Ob diese Kosten anfallen wird im Vorfeld schriftlich durch unseren Service mitgeteilt. Das Angebot kann dann angenommen oder abgelehnt werden. Unfrei eingesandte Ersatzteil-Bestellungen werden von uns nicht angenommen! Dieser Direktservice gilt für die Länder Deutschland, Benelux, Österreich, Frankreich, Großbritannien. Ersatzteil-Bestellungen aus den übrigen Ländern werden über die jeweiligen Distributeure abgewickelt. Bitte kontaktieren Sie Ihren Händler.

Besoin de pièces de rechange ?

Il vous suffit de contacter le service Revell et d'indiquer la référence de l'article et de la pièce. Soit en écrivant par mail à france@revell.de (uniquement pour la France) ou par courrier à Revell GmbH, Département X, Henschelstr. 20-30, D-32257 Bünde.*

*La garantie s'applique pour les articles présents au catalogue et achetés au cours des 24 derniers mois. Merci de votre compréhension. La commande de pièces de rechange peut donner lieu à des frais supplémentaires, par ex. pour l'emballage et le port. Notre service client vous en informera au préalable par écrit. Vous pourrez accepter ou refuser le devis. Nous n'acceptons pas les commandes de pièces de rechange envoyées sans affranchissement ! Ce service direct est valable pour les pays suivants : Allemagne, Benelux, Autriche, France, Grande-Bretagne. Les commandes de pièces en provenance d'autres pays sont traitées par les distributeurs correspondants. Veuillez contacter votre revendeur.

Need spare parts?

No problem. Contact Revell Service with the item number and part numbers you need: service@revell.de or Revell GmbH, Unit 10, Old Airfield Industrial Estate, Cheddington Lane, Tring, Herts, HP23 4QR, Great Britain.*

*We request your understanding that a warranty can only be accepted for current articles which have been purchased in the last 24 months. Orders for spare parts may also be subject to costs for packaging and shipping. You will be notified in advance by our Service department if such costs are incurred. The offer can then be accepted or rejected. We will not be able to process any postal requests unless correct postage has been applied to mailing! This direct service applies to the countries: Germany, Benelux, Austria, France, and the United Kingdom. Spare part orders from other countries are processed by the local distributors. Please contact your dealer.

Hebt u reserveonderdelen nodig?

Geen probleem! Neem eenvoudig contact op met de klantenservice van Revell en geef ons het artikel- en onderdeelnummer door. U kunt ons bereiken op service@revell.de of per post: Revell GmbH, Afdeling X, Henschelstr. 20-30, 32257 Bünde.*

*Wij vragen uw begrip voor de omstandigheid, dat er alleen garantie kan worden geboden voor actuele artikelen, die in de afgelopen 24 maanden zijn gekocht. Met het bestellen van reserveonderdelen kunnen kosten gemoeid zijn, bijv. voor verpakking en verzending. U wordt vooraf schriftelijk door onze klantenservice op de hoogte gesteld als er kosten zouden ontstaan. Het aanbod kan dan worden aangenomen of afgewezen. Wij nemen geen ongefrankeerde bestellingen van reserveonderdelen aan! Deze rechtstreekse service wordt verleend in de landen Duitsland, de Benelux, Oostenrijk, Frankrijk en Groot-Brittannië. Bestellingen van reserveonderdelen in de overige landen worden afgewikkeld via de betreffende distributeurs. Neem hiervoor contact op met uw verkoper.

