

## Bauanleitung

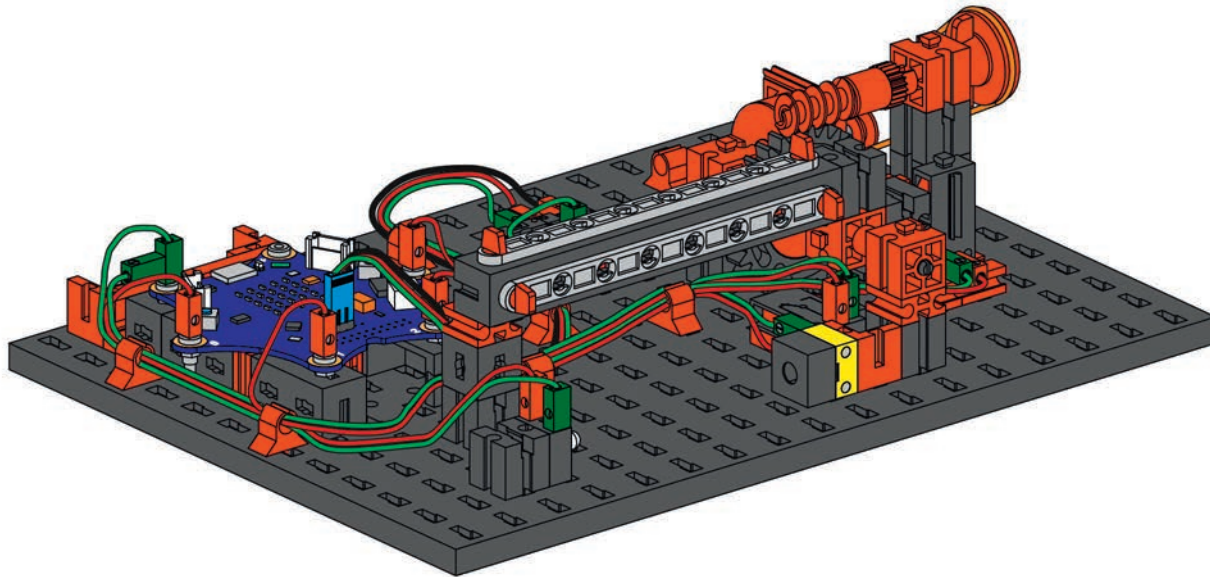



## ■ fischertechnik + Calliope: Wichtige Hinweise!

Die Modelle dieses Baukastens lassen sich mit dem Calliope Board ansteuern und mit einer der Programmierumgebungen programmieren, die für das Calliope Board erhältlich sind (z. B. Open Roberta).

**Das Calliope Board und die Software sind nicht Inhalt dieses Baukastens!**

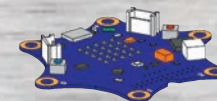

Das fischertechnik eLearning Portal bietet didaktisches Begleitmaterial zur Inbetriebnahme der fischertechnik Modelle zusammen mit dem Calliope Board, erste Schritte bei der Programmierung, Aufgabenstellungen und Lösungen für jedes Modell zusammen mit der Programmierumgebung Open Roberta.

[www.fischertechnik.de/elearning/calliope](http://www.fischertechnik.de/elearning/calliope)

### weitere Links:

Calliope Board:

[www.calliope.cc](http://www.calliope.cc)

Programmierumgebung Open Roberta:

[www.open-roberta.org](http://www.open-roberta.org)

# Inhalt

Einzelteilübersicht..... 2

Montagetipps ..... 4

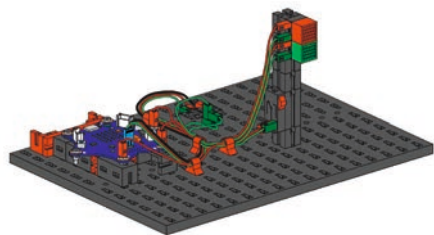

Fußgängerampel ..... 8

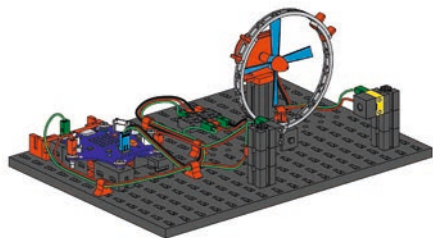



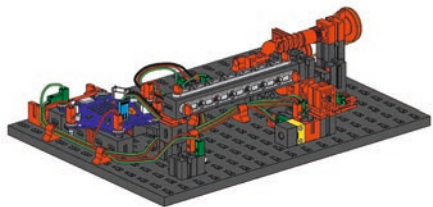















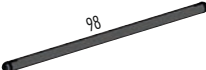
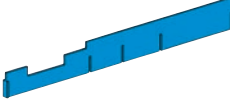



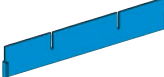



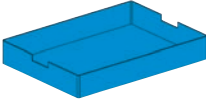

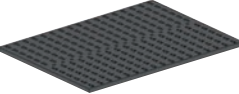



















Händetrockner..... 12

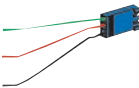

Schranke ..... 17

# Einzelteilübersicht

|   |                |   |               |  |               |  |               |
|---|----------------|---|---------------|--|---------------|--|---------------|
|  | 31 023<br>1 x  |  | 31 982<br>2 x |   | 35 079<br>1 x |   | 36 324<br>1 x |
|  | 31 032<br>1 x  |  | 32 064<br>4 x |   | 35 084<br>1 x |   | 36 337<br>1 x |
|  | 31 058<br>2 x  |  | 32 879<br>1 x |  | 35 414<br>1 x |   | 36 356<br>2 x |
|  | 31 124<br>1 x  |  | 32 881<br>5 x |   | 35 969<br>7 x |   | 36 357<br>2 x |
|  | 31 336<br>10 x |  | 32 882<br>2 x |   | 36 134<br>1 x |   | 36 360<br>1 x |
|  | 31 337<br>11 x |  | 32 985<br>1 x |  | 36 264<br>1 x |   | 36 443<br>1 x |
|  | 31 602<br>1 x  |  | 35 031<br>2 x |  | 36 293<br>1 x |   | 36 532<br>1 x |
|  | 31 915<br>1 x  |  | 35 049<br>3 x |   | 36 323<br>4 x |  | 36 920<br>4 x |

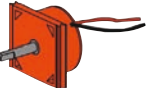
|   |               |   |               |  |                |   |                |
|---|---------------|---|---------------|--|----------------|---|----------------|
|  | 36 950<br>3 x |  | 37 679<br>1 x |   | 38 240<br>3 x  |  | 162 135<br>2 x |
|  | 36 977<br>4 x |  | 37 681<br>1 x |   | 136 775<br>1 x |  | 167 257<br>1 x |
|  | 36 981<br>1 x |  | 37 783<br>2 x |  | 137 125<br>1 x |  | 167 258<br>6 x |
|  | 37 237<br>3 x |  | 37 858<br>1 x |  | 153 670<br>3 x |  | 167 259<br>6 x |
|  | 37 468<br>8 x |  | 38 216<br>2 x |  | 156 494<br>1 x |   |                |

**Das Calliope Board und die Software sind nicht Inhalt dieses Baukastens!**



## Sicherheitshinweise

- Achtung! Verletzungsgefahr an Bauteilen mit funktionsbedingten scharfen Kanten und Spitzen!
- Alle Einzelteile, insbesondere bewegliche Teile sind falls notwendig zu warten und zu reinigen.

# Montagetipp

Kabel und Stecker

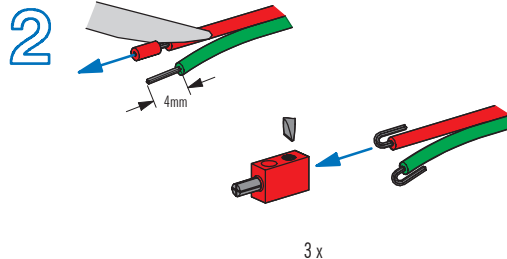
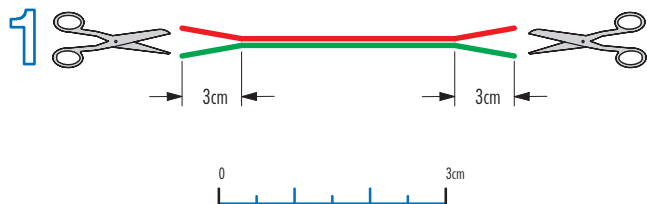

4

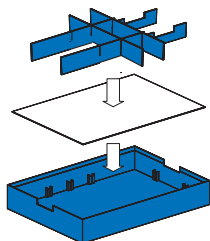
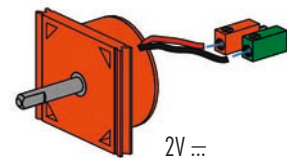
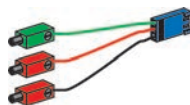

# Erste Schritte oder Vormontage

**1**



1 x

6 x

6 x

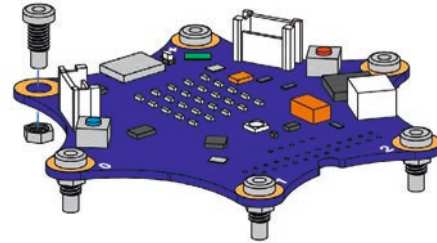

Stecker als Hilfsmittel verwenden

**2**

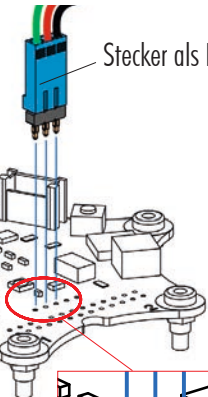

1 x

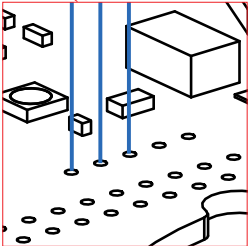

**3**

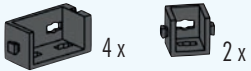



4 x

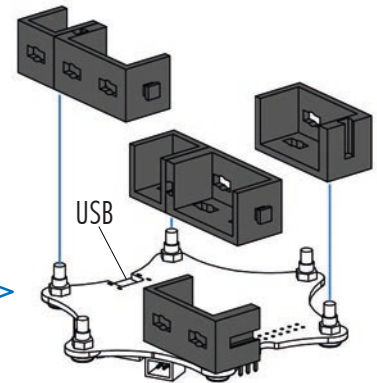

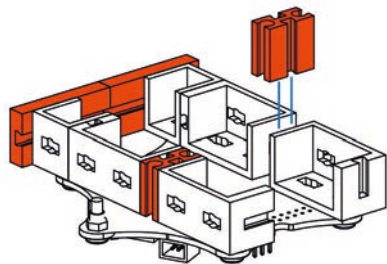

2 x



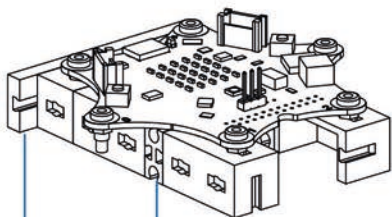

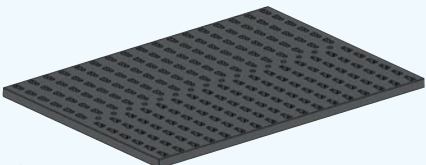
**4**  2x  2x



**5**  1x  
 2x  2x  2x

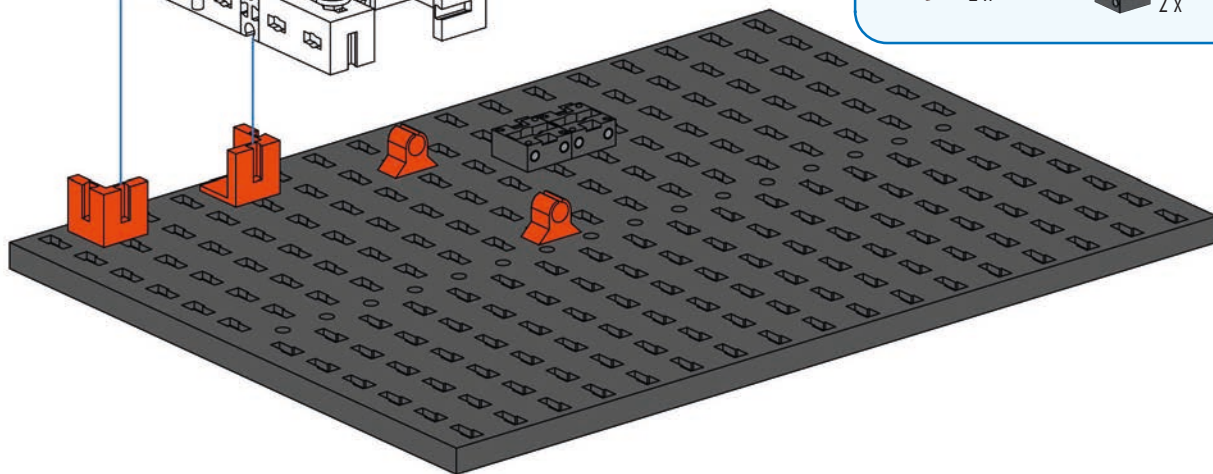



6

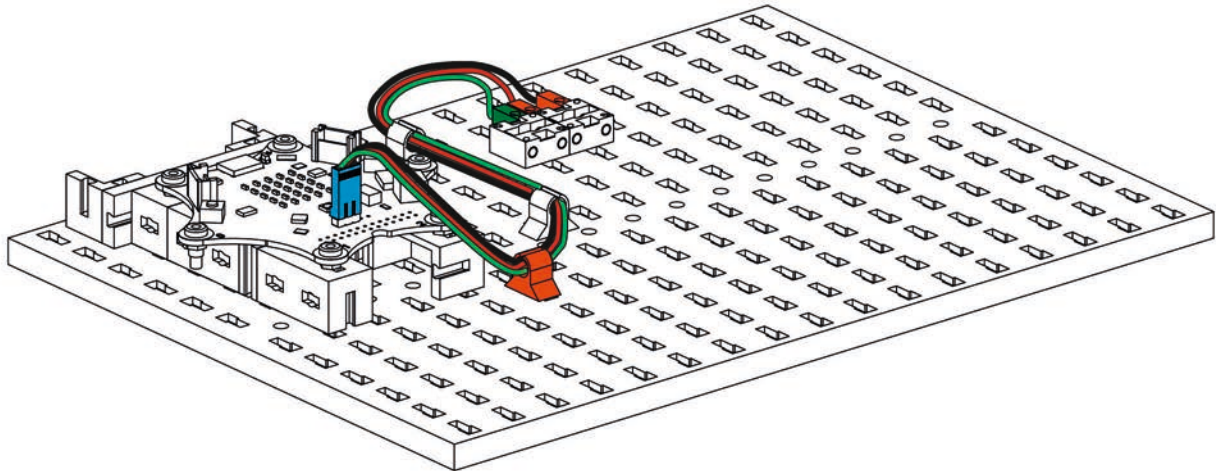
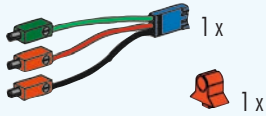

**Dieser Aufbau kann bei allen Modellen unverändert übernommen werden!**

# Fußgängerampel

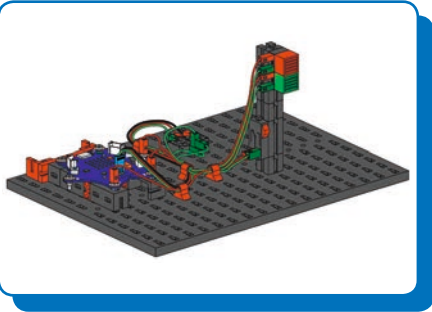

**1**

1x

1x

3x

1x

1x

This block contains the first assembly step. It shows a callout box with a pink number '1' and a diagram of the assembly on a grey base plate. To the right of the diagram is a list of parts: one grey Technic 1x3 brick, three grey Technic 1x2 bricks, one grey Technic 1x2 brick with a red notch, and one red Technic 1x2 brick.

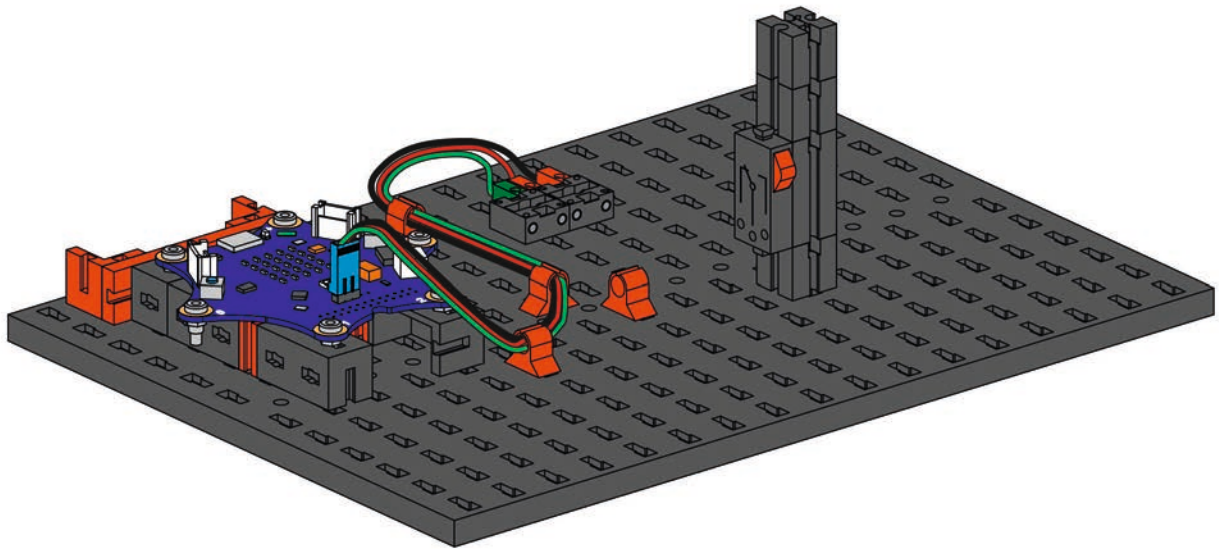

2

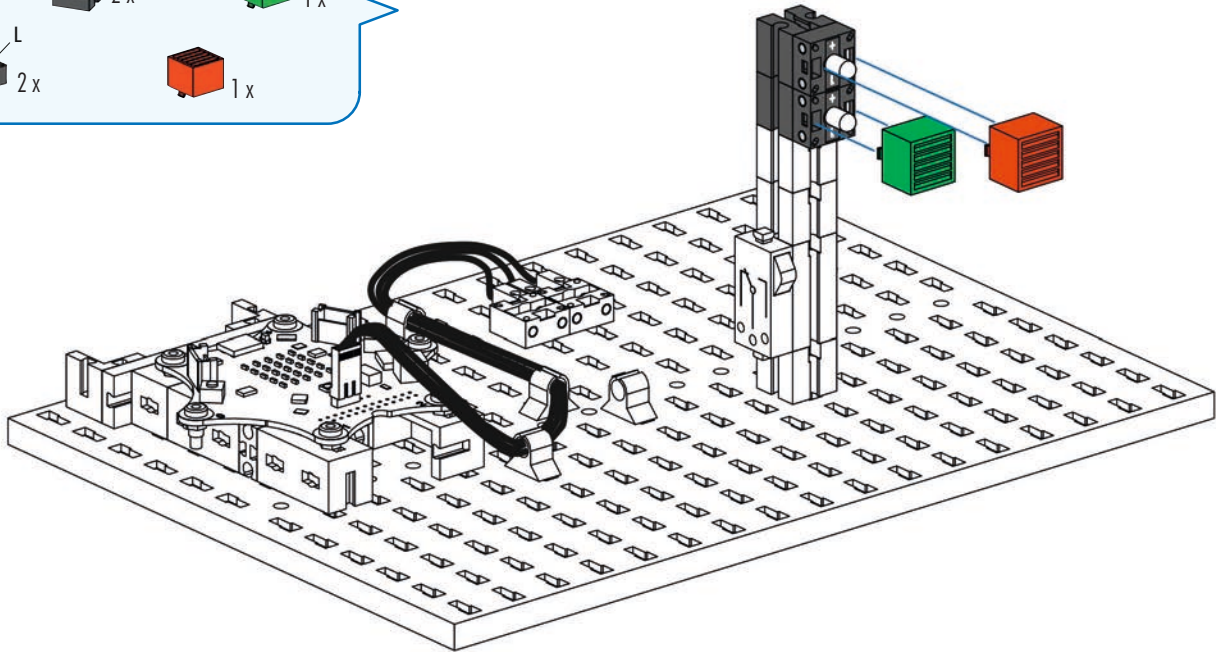
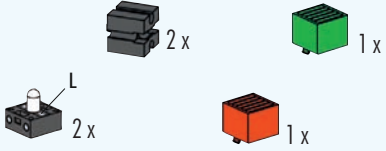

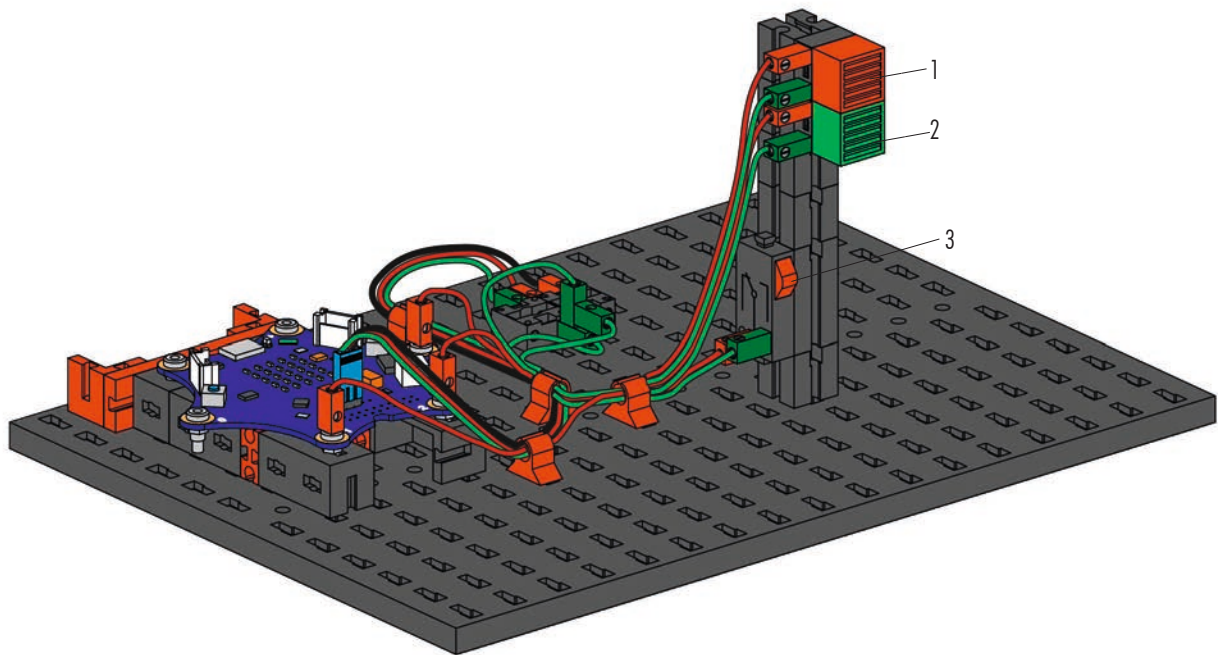

## Schaltplan

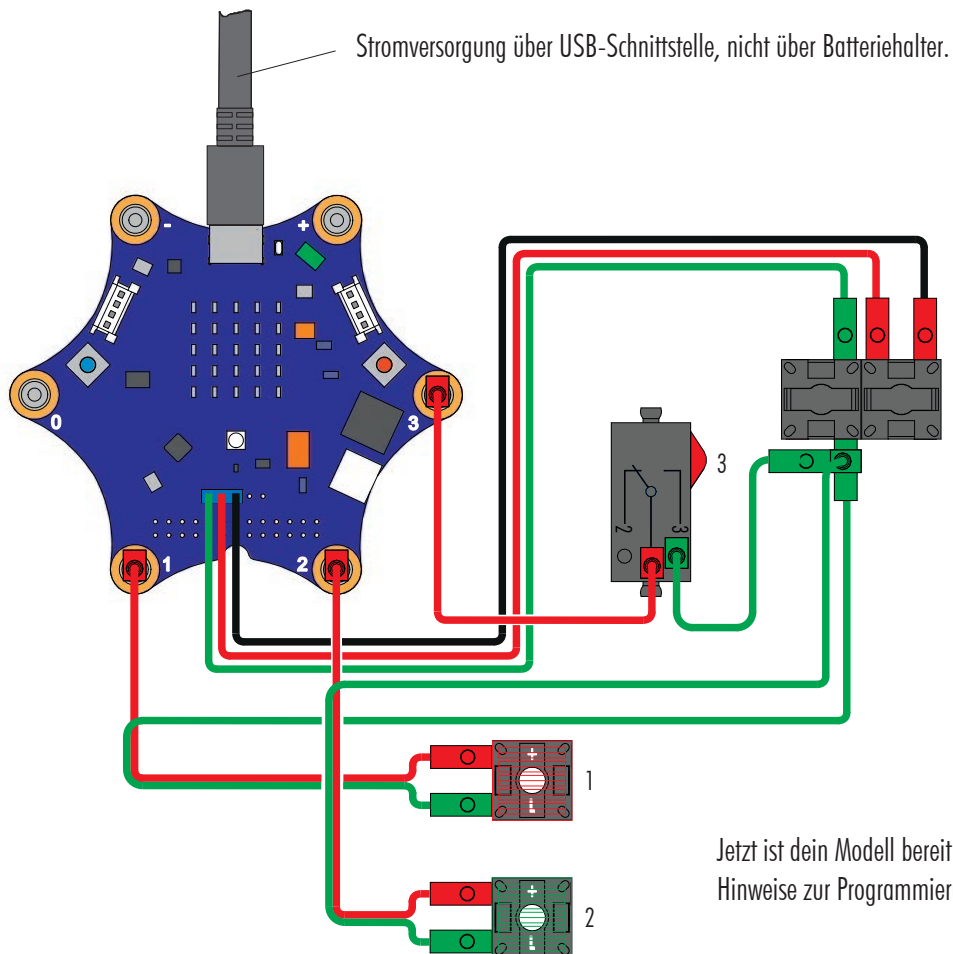

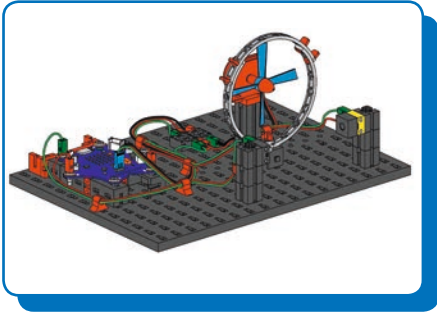

## Händetrockner

**1**

1x

1x 3x

1x 1x 2x

Diagram illustrating the first step of assembly. A grey Technic base plate is shown with a blue PCB and other components. A red '1' indicates the step number. The diagram shows the placement of various parts: one grey 1x3 Technic brick, three grey 1x3 Technic bricks, one orange 1x2 Technic brick, one orange 1x2 Technic brick, and two orange 1x2 Technic bricks.

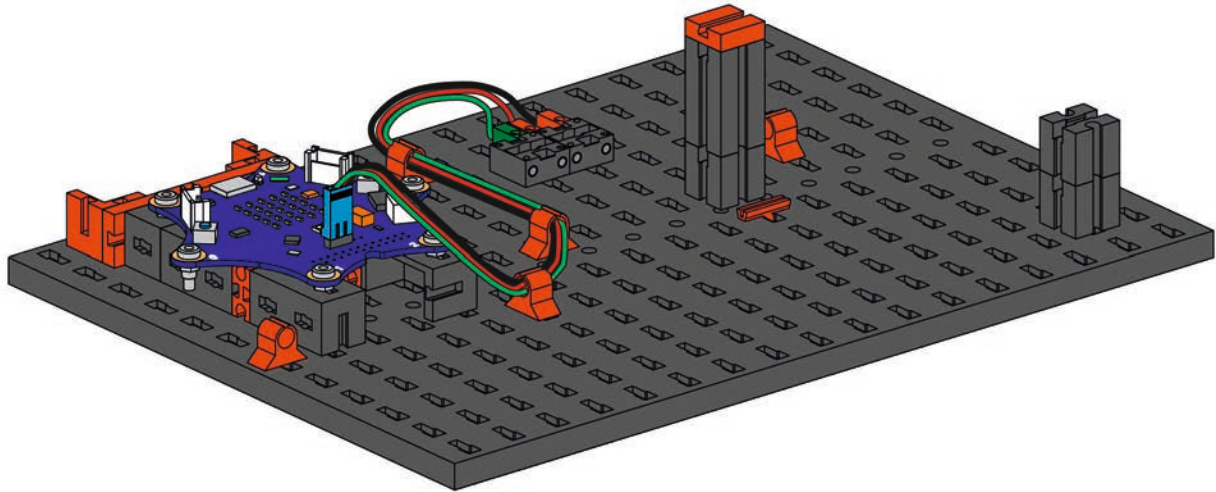

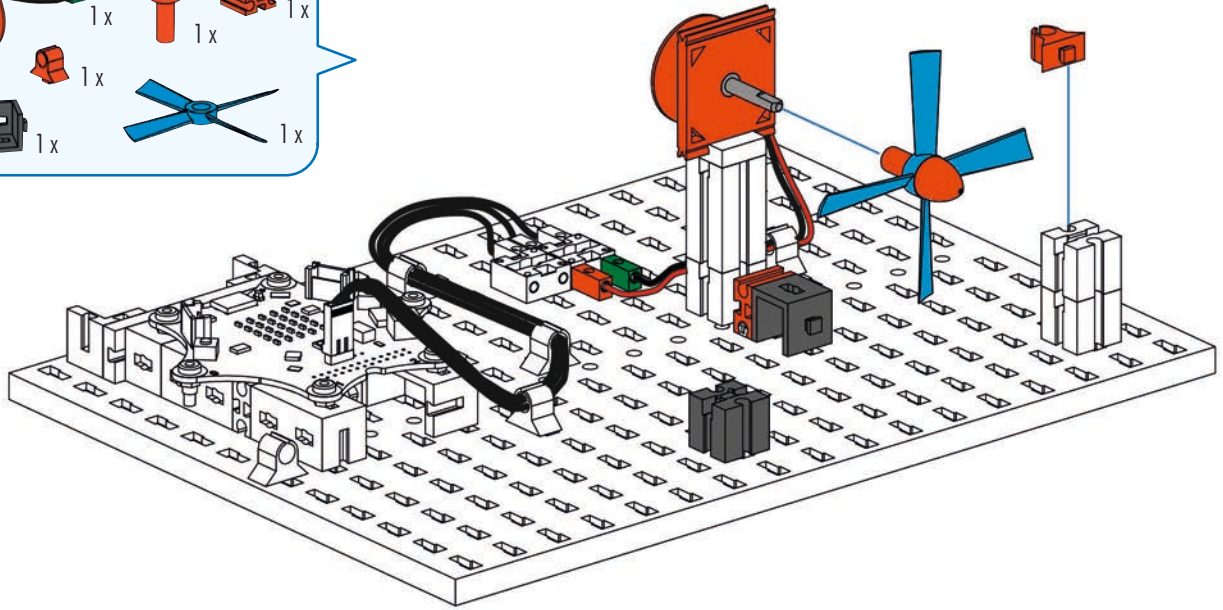
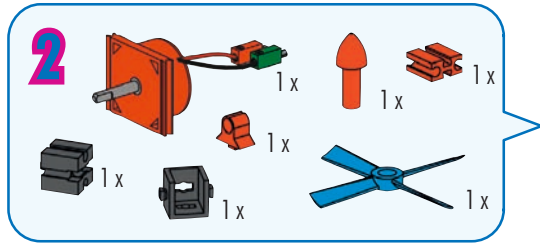

3

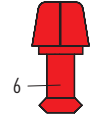
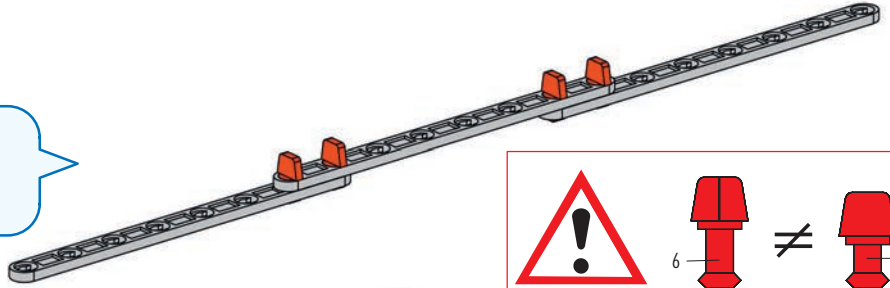

≠

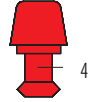

4

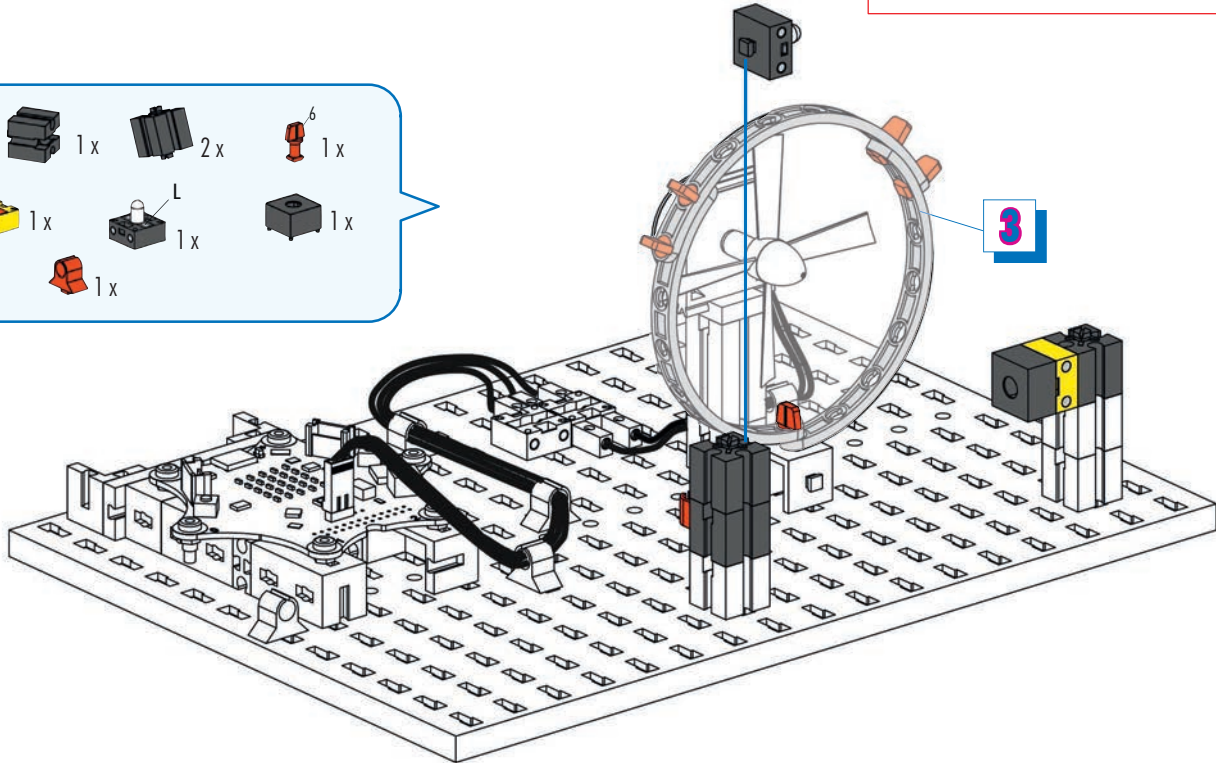
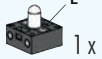



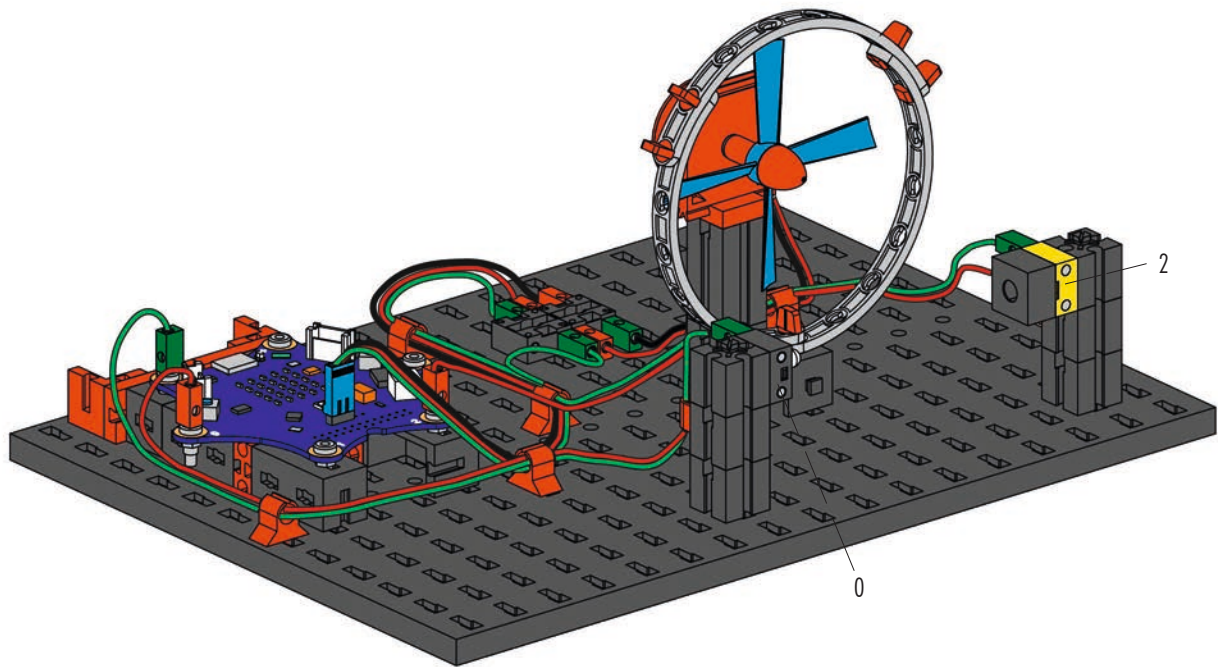

## Schaltplan

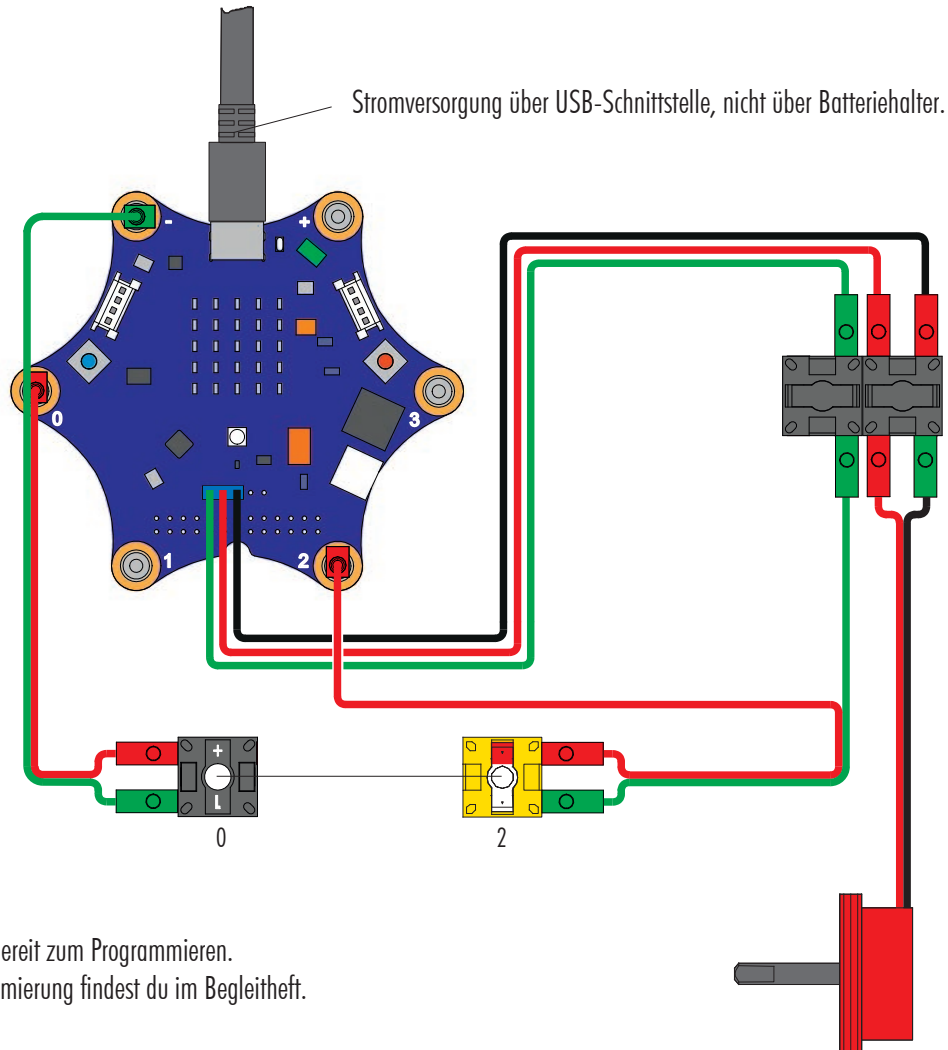

Jetzt ist dein Modell bereit zum Programmieren.  
Hinweise zur Programmierung findest du im Begleitheft.

## Schranke

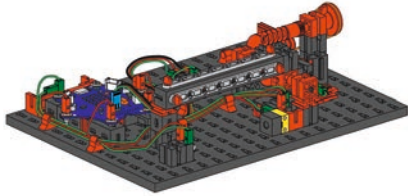

1

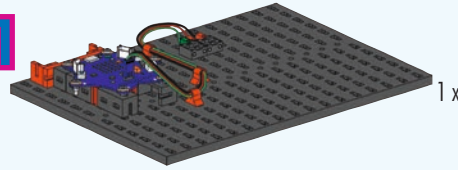

3x

4x

1x

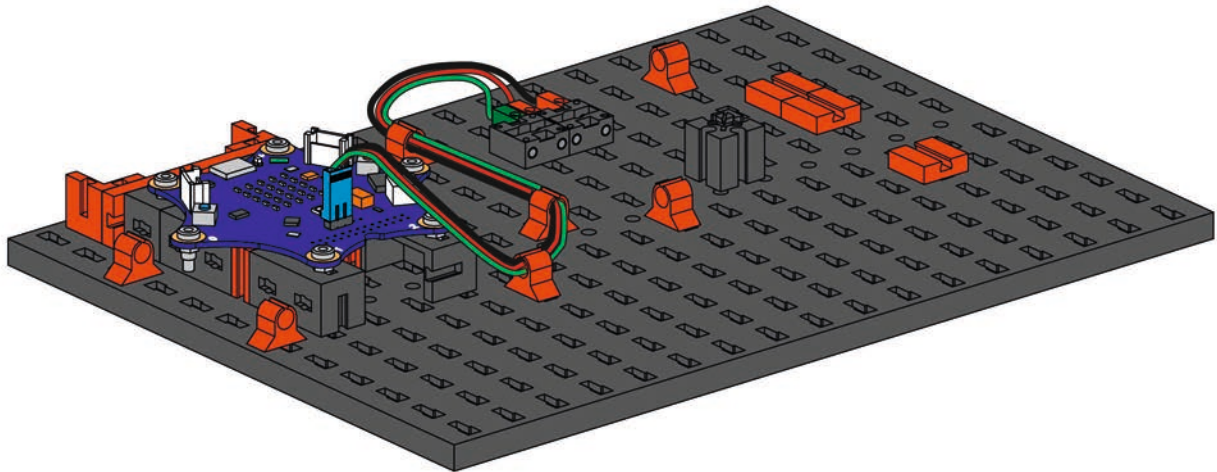

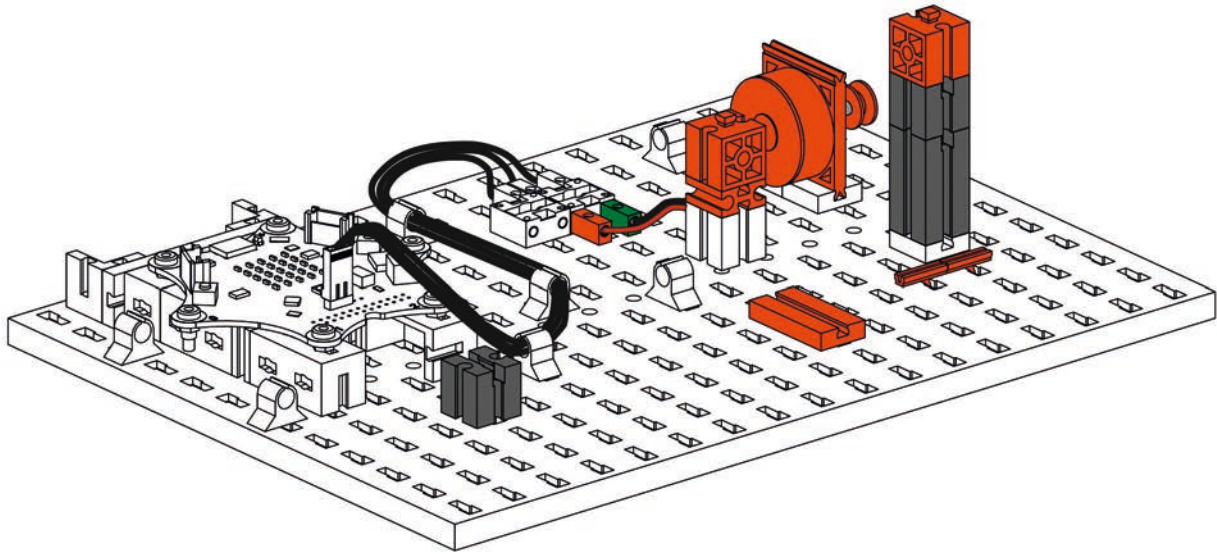
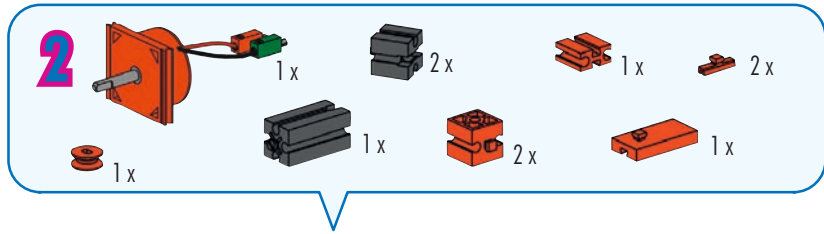





6

- 1x [Black 1x3 Pin Header]
- 2x [Orange 1x3 Pin Header]
- 1x [Black 1x3 Pin Header]
- 1x [Black 1x3 Pin Header with LED]

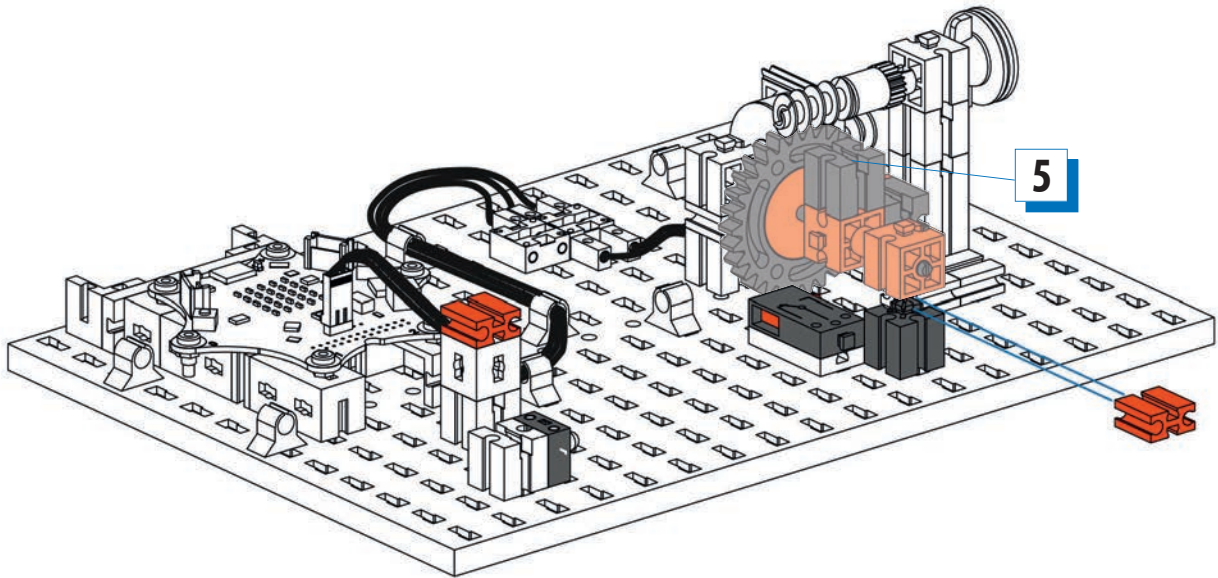

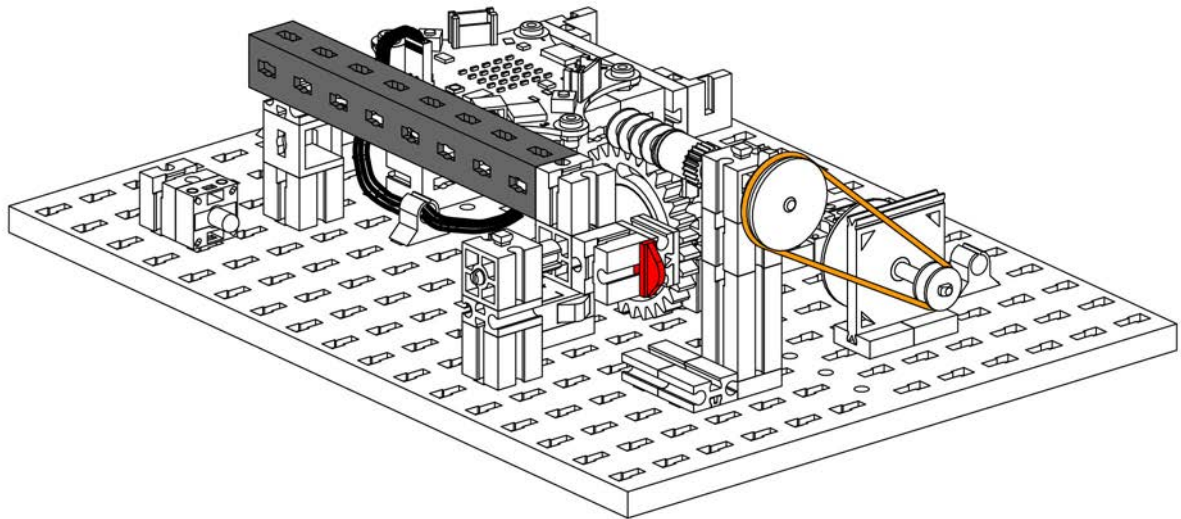
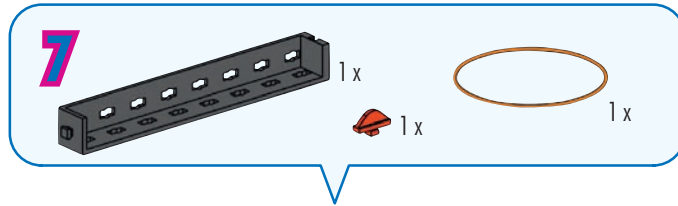



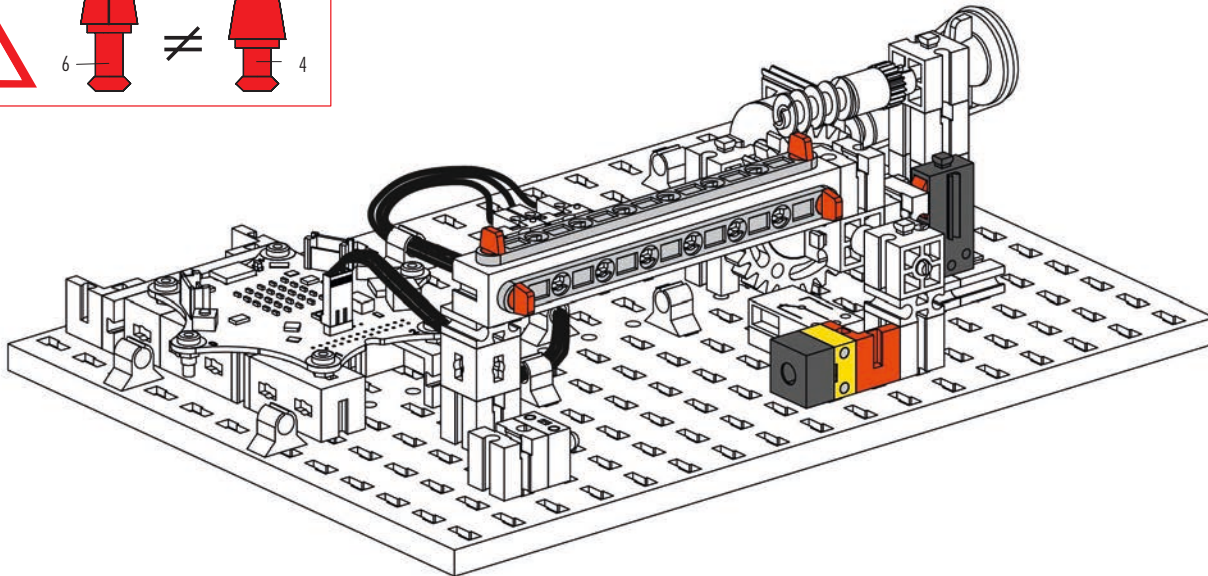
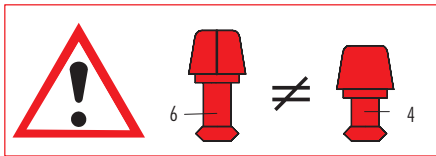
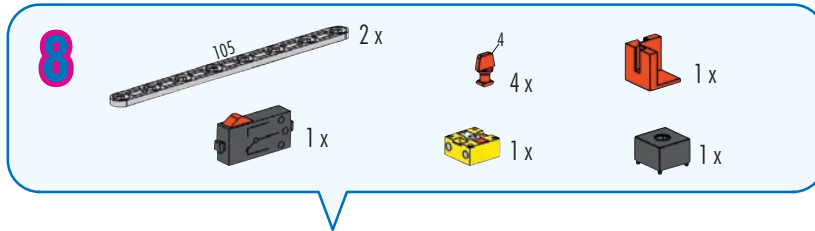

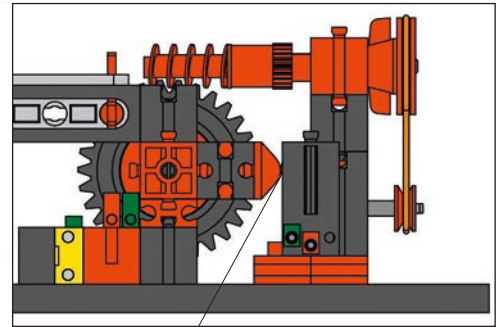
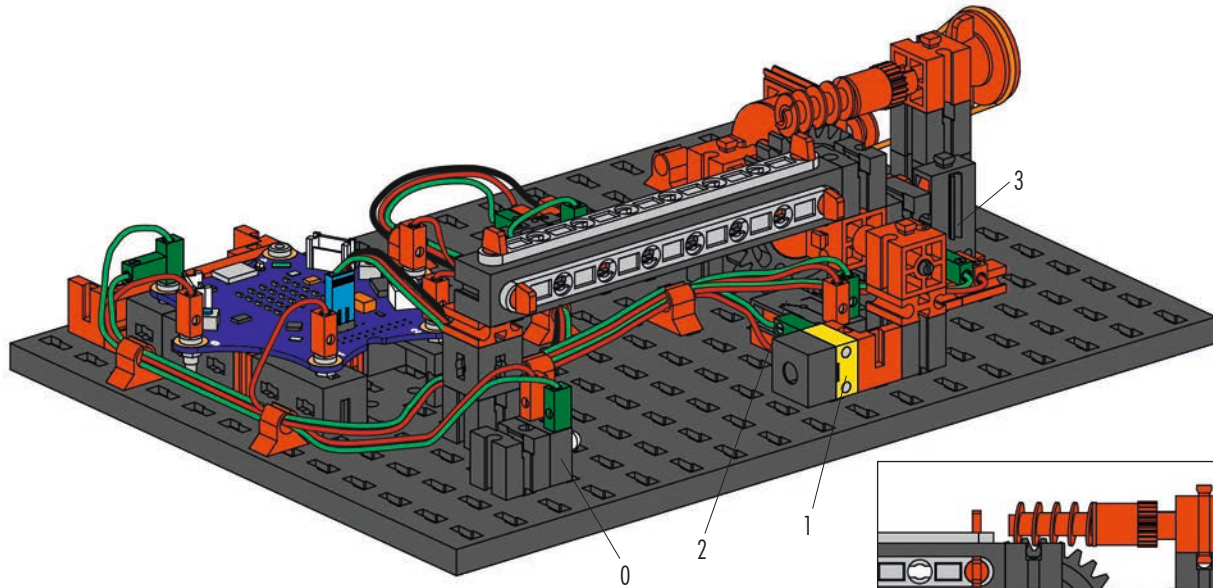

Taster gedrückt wenn Schranke geschlossen

## Schaltplan

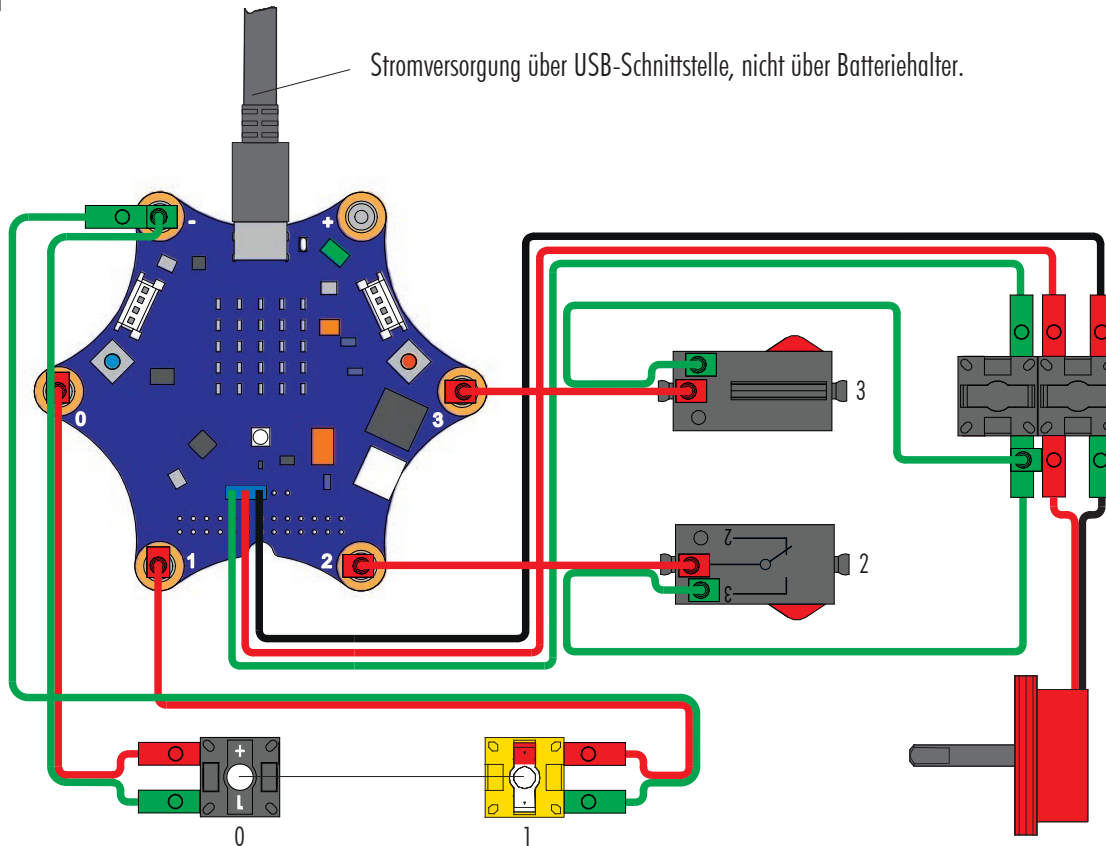

Jetzt ist dein Modell bereit zum Programmieren.  
Hinweise zur Programmierung findest du im Begleitheft.

**fischertechnik**



**CALLIOPE**

fischertechnik GmbH  
Klaus-Fischer-Str. 1  
72178 Waldachtal  
Germany

Phone: +49 74 43/12-4369  
Fax: +49 74 43/12-4591

info@fischertechnik.de  
www.fischertechnik.de

