

reflecta[®]

DigiMicroscope Vario

Bedienungsanleitung
für xpoview v 3.2

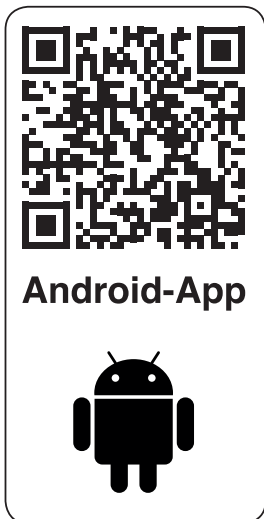
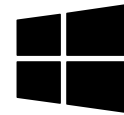

Android-App



DE

EN

FR

ES

IT

NL

DE

INHALT

VOR DER VERWENDUNG	4
Wichtige Informationen.....	4
Pflege und Wartung.....	4
Warnung	4
Produktbeschreibung	5
Computeranforderungen	5
AUF EINEN BLICK	6
Lieferumfang	6
Produktübersicht	7
Spezifikationen	8
ERSTE SCHRITTE	9
Softwareinstallation	9
Anschließen des Gerätes	10
Starten der xploview-Software.....	10
Einlegen eines Objektträgers.....	11
GRUNDLAGEN.....	12
Auswahl einer Lichtquelle.....	12
Auswahl einer Vergrößerungsleistung	13
Blende.....	14
Eine Momentaufnahme machen.....	15
VERWENDUNG DER XPLOVIEW-SOFTWARE.....	16
Menüleiste.....	16
Anzeige im Vollbild	17
Bild drehen/spiegeln.....	18
Systemeinstellungenmenü	19
Geräte-Setup	20
Einrichtung der zeitgesteuerten Aufnahme	20
Film-Einrichtung.....	20
Speicherort einrichten	21
Spracheinstellung	21
Erweiterte Einstellungen	22
Gespeicherte Dateien.....	23
Deinstallieren der xploview-Software.....	23

VOR DER VERWENDUNG

Wichtige Informationen

Bitte lesen Sie diese Bedienungsanleitung vor der Verwendung dieses Produktes sorgfältig durch und bewahren diese zum späteren Nachschlagen auf.

Verbesserungen und Änderungen an diesem Text aufgrund von Druckfehlern oder Verbesserungen der Software bzw. Geräte, können jederzeit ohne vorherige Ankündigung vorgenommen werden.

Pflege und Wartung

- Vermeiden Sie Vibrationen, Stöße und Drücke, z. B. ein Fallenlassen des Mikroskops.
- Halten Sie das Gerät trocken und schützen Sie es vor Wasser oder Dampf.
- Belassen Sie das Gerät nicht an einem Ort, an dem es extrem hohen oder niedrigen Temperaturen ausgesetzt ist.
- Berühren Sie das Gerät nicht mit feuchten Händen, da es hierdurch beschädigt werden kann und für den Benutzer die Gefahr eines elektrischen Schlages besteht.
- Verwenden oder lagern Sie dieses Gerät nicht in staubigen, schmutzigen Umgebungen, da hierdurch die beweglichen Komponenten beschädigt werden können.
- Verwenden Sie für die Reinigung des Gerätes keine ätzenden Chemikalien, Lösungsmittel oder Aerosole. Wischen Sie das Mikroskop mit einem weichen Tuch ab, das mit einer milden Seifenlösung befeuchtet ist.

Warnung

- Setzen Sie das beleuchtete digitale Mikroskop niemals auf das Auge, da hierdurch eine bleibende Beschädigung des Auges verursacht werden kann.
- Versuchen Sie nicht, das Mikroskop zu öffnen oder zu zerlegen.

Produktbeschreibung

- Dieses Produkt unterscheidet sich von einem herkömmlichen Lichtmikroskop, bei dem durch ein Okular geschaut wird, da das vergrößerte Bild oder Live-Video über eine USB-Verbindung auf einem Computer-Monitor wiedergegeben wird.
- Dieses Produkt verfügt über einen integrierten Objektivrevolver mit sechs unterschiedlichen Objektiven. Bei der Anzeige von Bildern auf einem 17" Monitor kann dieses Mikroskop Proben mit einer 100-fachen, 200-fachen, 300-fachen, 400-fachen, 500-fachen und 600-fachen Vergrößerung anzeigen. Die Vergrößerung ist abhängig von der Größe des Computermonitors - je größer der Monitor, desto höher die Vergrößerung.
- Mit dem oben auf dem Gerät befindlichen Fotoauslöser können Momentaufnahmen der Exemplare erfasst werden. Mit der bereitgestellten Software können ebenfalls Live-Videos und Momentaufnahmen erfasst und auf dem Computer gespeichert werden.

Computeranforderungen

Windows-basierter PC

Kompatible Betriebssysteme

Windows 10 (32 Bit oder 64 Bit)

Windows 8 (32 Bit oder 64 Bit)

Windows 7 (32 Bit oder 64 Bit)

Windows Vista (32 Bit oder 64 Bit)

Windows XP SP2, SP3

USB

USB 2.0

Mac OS-basierter PC

Kompatible Betriebssysteme

Mac OS X 10.5.6 - Mac OS X 10.11.x

USB

USB 2.0

AUF EINEN BLICK

Lieferumfang

Digitales Mikroskop mit
USB-Kabel

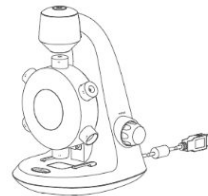

3 leere Objektträger,
Vorbereiteter Objektträger
mit Baumwoll-Stoffprobe



Pinzette

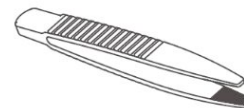

6 leere Objektträger-Deckel

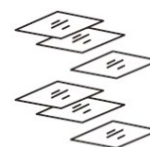

Installations-CD



Benutzerhandbuch



Pipette



Produktübersicht

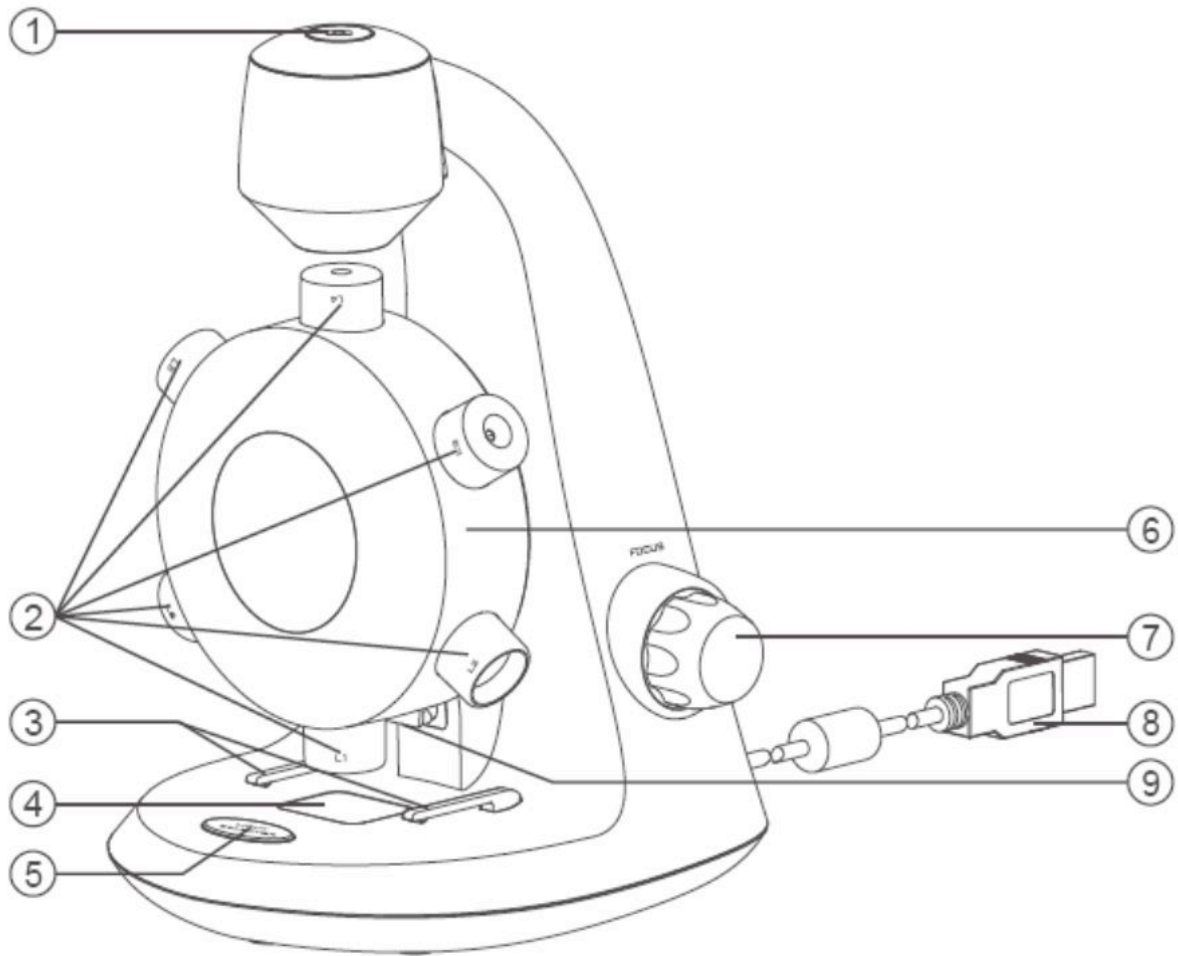

1. Fotoauslöser
2. Objektive
3. Präparatehalter
4. Objektisch
5. Licht-Wahlschalter
6. Objektivrevolver
7. Blenden-Regler
8. USB-Kabel
9. LED

Spezifikationen

Verbindungstyp	USB 2.0
Effektiver Beobachtungsbereich	L1 = 3,6 x 2,7 mm L2 = 1,8 x 1,4 mm L3 = 1,2 x 0,9 mm L4 = 0,9 x 0,7 mm L5 = 0,7 x 0,5 mm L6 = 0,6 x 0,45 mm
Vergrößerungsleistung (Anzeige auf einem 17" Monitor)	L1 = 100x L2 = 200x L3 = 300x L4 = 400x L5 = 500x L6 = 600x
Beleuchtung	LED
Stromversorgung	5 V $\overline{\text{---}}$ 250 mA (über USB)
Sensor	CMOS
Maximale Fotoauflösung	1600 x 1200 Pixel (UXGA)
Maximale Videoaufnahme-Auflösung	640 x 480 Pixel (VGA)
Abmessungen	130 mm x 154 mm x 208 mm
Gewicht	369 Gramm



ERSTE SCHRITTE

Softwareinstallation

Windows-basierter PC

- Legen Sie die mitgelieferte CD der Anwendung in das CD-ROM-Fach des Computers.
- Doppelklicken Sie auf das Symbol „xploview v3.2.xx.exe“ <  > auf der Treiber-CD.
- Folgen Sie dem Setup-Assistenten für xploview, um die Anwendungssoftware für das digitale Mikroskop zu installieren.

Mac OS-basierter PC

- Legen Sie die mitgelieferte CD der Anwendung in das CD-ROM-Fach des Computers.
- Doppelklicken Sie auf das Symbol „xploview v3.2.xx.dmg“ <  > auf der Treiber-CD.
- Ziehen Sie das xploview-Symbol <  > in den Applicationsordner.

Anschließen des Gerätes

Verbinden Sie das Mikroskop mithilfe des mitgelieferten USB-Kabels mit dem Computer.

Starten der xploview-Software

Windows-basierter PC

Die xploview-Software kann von dem Desktop oder im Startmenü mit einem Doppelklick auf das xploview-Symbol gestartet werden.

Mac OS-basierter PC

Die xploview-Software kann aus dem Anwendungsmenü mit einem Doppelklick auf das xploview-Symbol gestartet werden.

Hinweis

Wenn das Mikroskop zum ersten Mal an den Computer angeschlossen wird, wird von Windows oder Mac OS automatisch ein Treiber installiert. Dieser Vorgang kann einige Minuten in Anspruch nehmen.

Jedes Mal, wenn die xploview-Software gestartet wird, sollte das Mikroskop automatisch starten. Ansonsten kann das Gerät in dem Abschnitt „Gerät einrichten“ in dem Systemeinstellungenmenü ausgewählt werden.

Einlegen eines Objektträgers

Legen Sie einen vorbereiteten Objektträger auf den Objektisch und schieben ihn so unter die Präparatehalter, dass der Objektträger von diesen sicher gehalten wird.

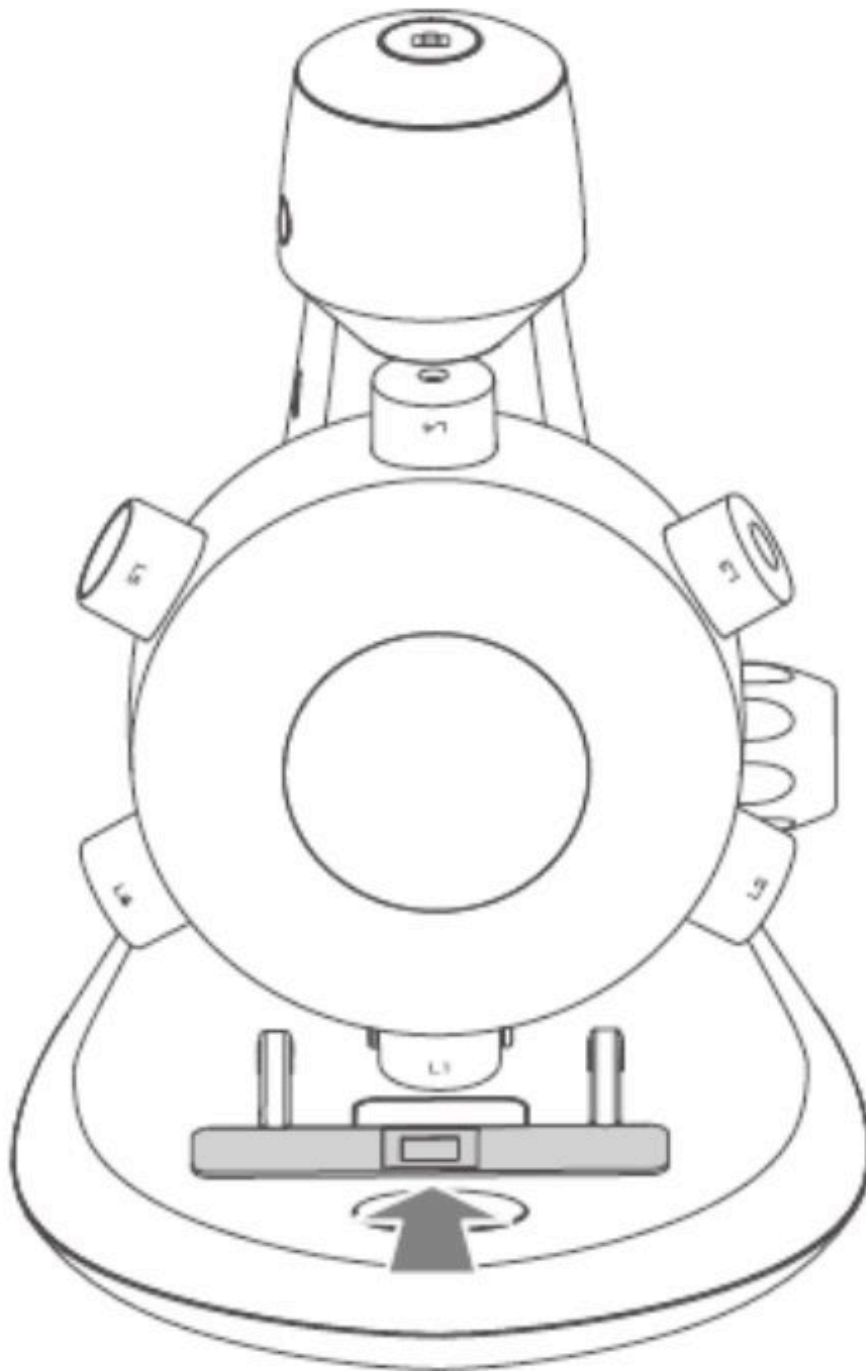

GRUNDLAGEN

Auswahl einer Lichtquelle

Dieses digitale Mikroskop ist mit zwei Lichtquellen ausgestattet, von denen sich eine oberhalb und eine unterhalb des Objektträgers befindet. Hierdurch wird eine Auflicht- und Durchlicht-Beleuchtung bereitgestellt.

Wenn das Mikroskop an einen Computer angeschlossen wird, wird beim Aufrufen der mitgelieferten Software eine der Beleuchtungen angeschaltet.

Drücken Sie den Licht-Wahlschalter einmal, um das gewünschte Beleuchtungssystem auszuwählen. Beim Beenden der Software wird die Beleuchtung automatisch ausgeschaltet.

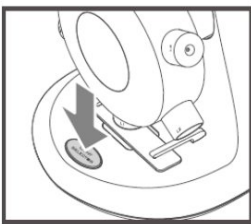

Drücken Sie Schalter einmal, um zum Beleuchtungssystem zu wechseln

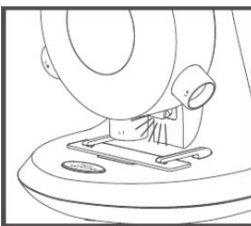

Auflicht-Beleuchtung

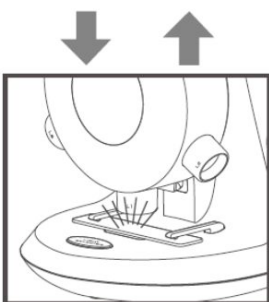

Durchlicht-Beleuchtung

Auswahl einer Vergrößerungsleistung

Der Objektivrevolver kann in beide Richtungen gedreht werden - im Uhrzeigersinn oder gegen den Uhrzeigersinn.

Nehmen wir als Beispiel das weniger leistungsstarke Objektiv, L1, und drehen den Objektivrevolver so, dass sich L1 direkt über der Probe befindet. Wenn das Objektiv korrekt ausgerichtet ist, können Sie einen „Klick“ fühlen.

Drehen Sie den Objektivrevolver, um die gewünschte Vergrößerung auszuwählen.

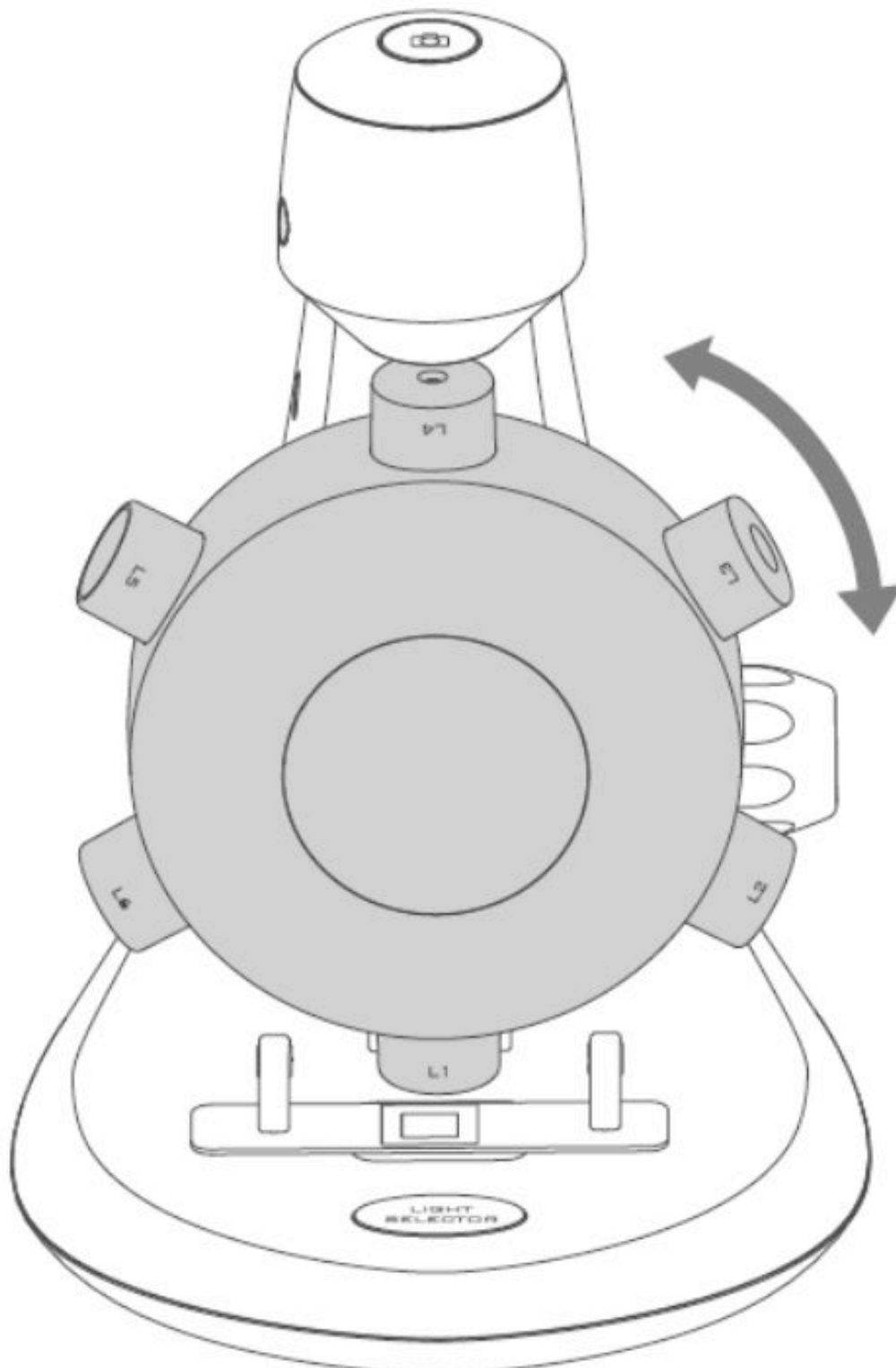

Blende

Drehen Sie den Blenden-Regler im Uhrzeigersinn oder gegen den Uhrzeigersinn, bis das Bild scharf ist.

Hinweis: Bitte stellen Sie sicher, dass das Objektiv frei von Hindernissen ist und den Objektträger nicht berührt, während der Objektivrevolver zur Fokussierung abgesenkt wird.

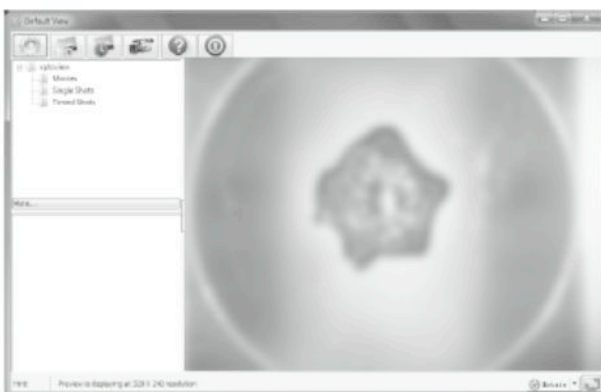
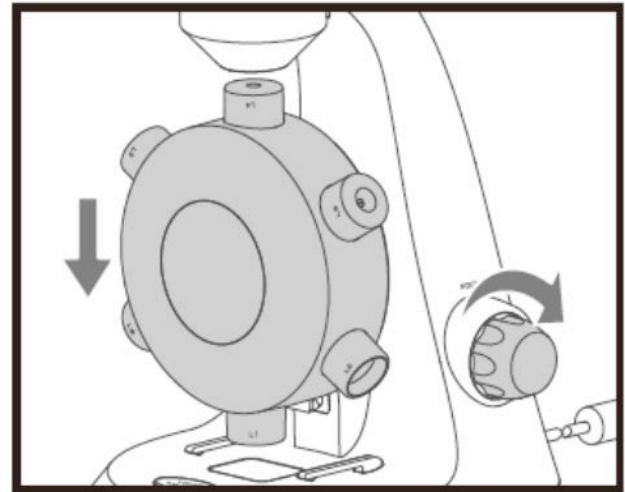
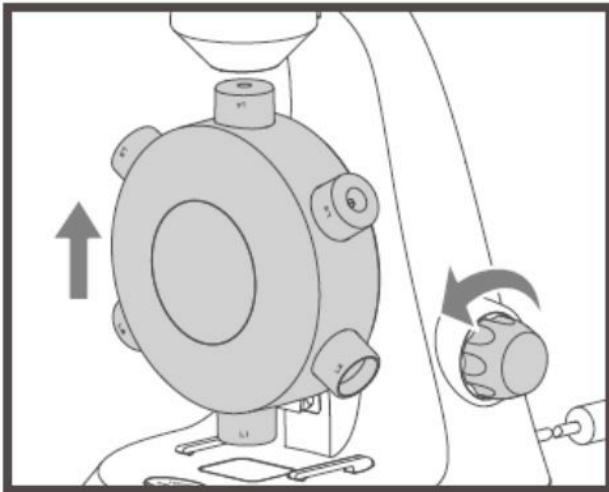

Eine Momentaufnahme machen

Drücken Sie den Fotoauslöser, um eine Momentaufnahme zu erfassen.

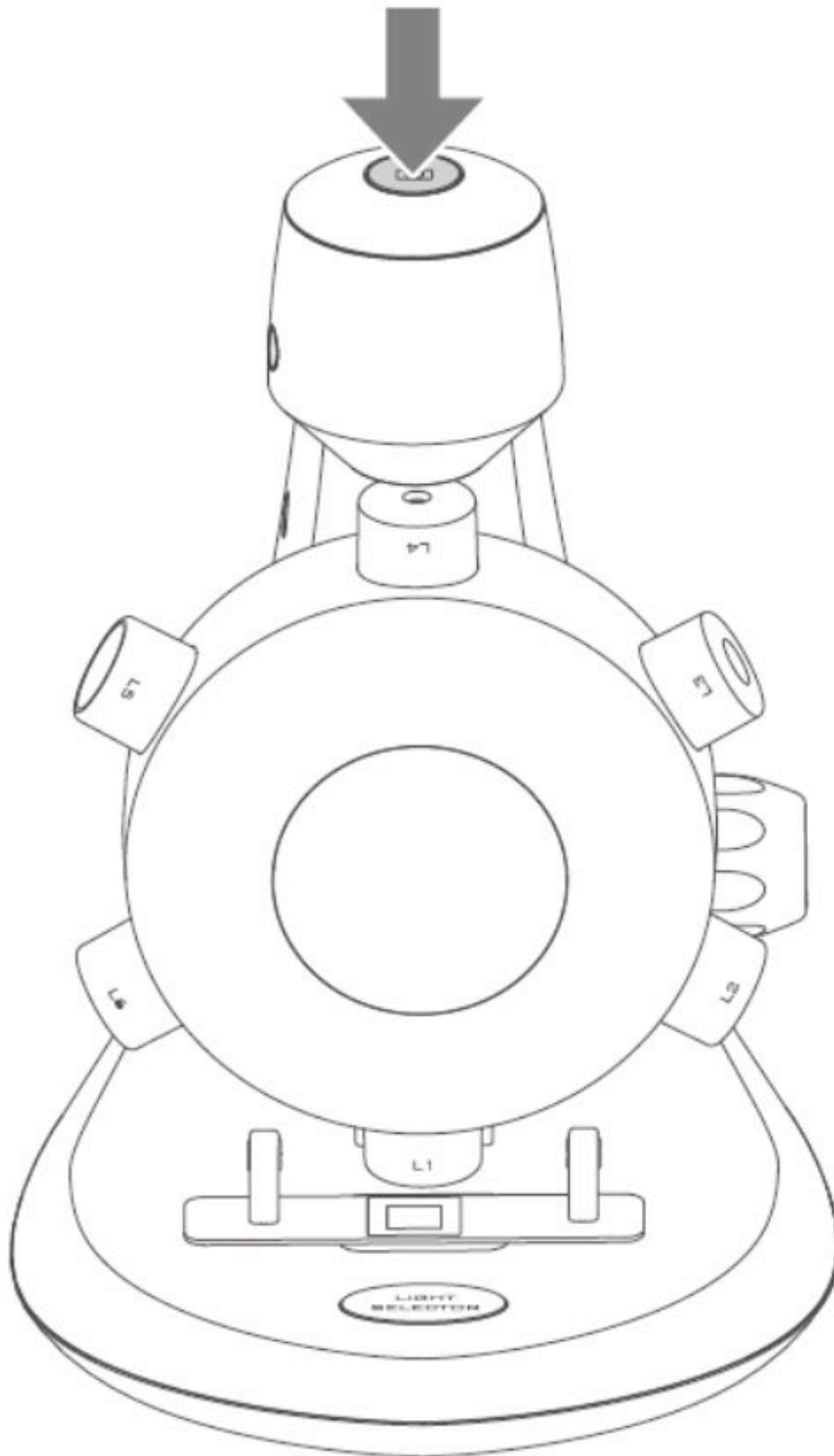

VERWENDUNG DER XPLOVIEW-SOFTWARE

Menüleiste

Die Symbole in der Menüleiste:



Öffnen des **Systemeinstellungenmenüs**
(siehe Systemeinstellungenmenü auf Seite 19).



Aufnahme eines Bildschirm-Bildes.



Starten und stoppen einer **zeitgesteuerten Aufnahme**. Bilder werden in regelmäßigen Abständen aufgenommen (siehe Systemeinstellungenmenü auf Seite 20, um die Häufigkeit und Dauer einzustellen).



Starten und stoppen einer **Videoaufnahme**.



Informationen über die Anwendungssoftware. Diese Informationen können bei einer Aktualisierung der Software hilfreich sein.



Beenden der Anwendungssoftware.

Anzeige im Vollbild

Um den Vollbildmodus zu aktivieren, klicken Sie auf die Schaltfläche „Vollbild“ < >, die sich in der unteren rechten Ecke des Fensters der xploview-Anwendungssoftware befindet.

Um den Vollbildmodus zu verlassen, führen Sie entweder einen Doppelklick auf den Bildschirm aus oder drücken Sie die Taste „Esc“ auf der Tastatur.



Bild drehen/spiegeln

Klicken Sie auf die Schaltfläche , um das Bild zu drehen oder zu spiegeln.

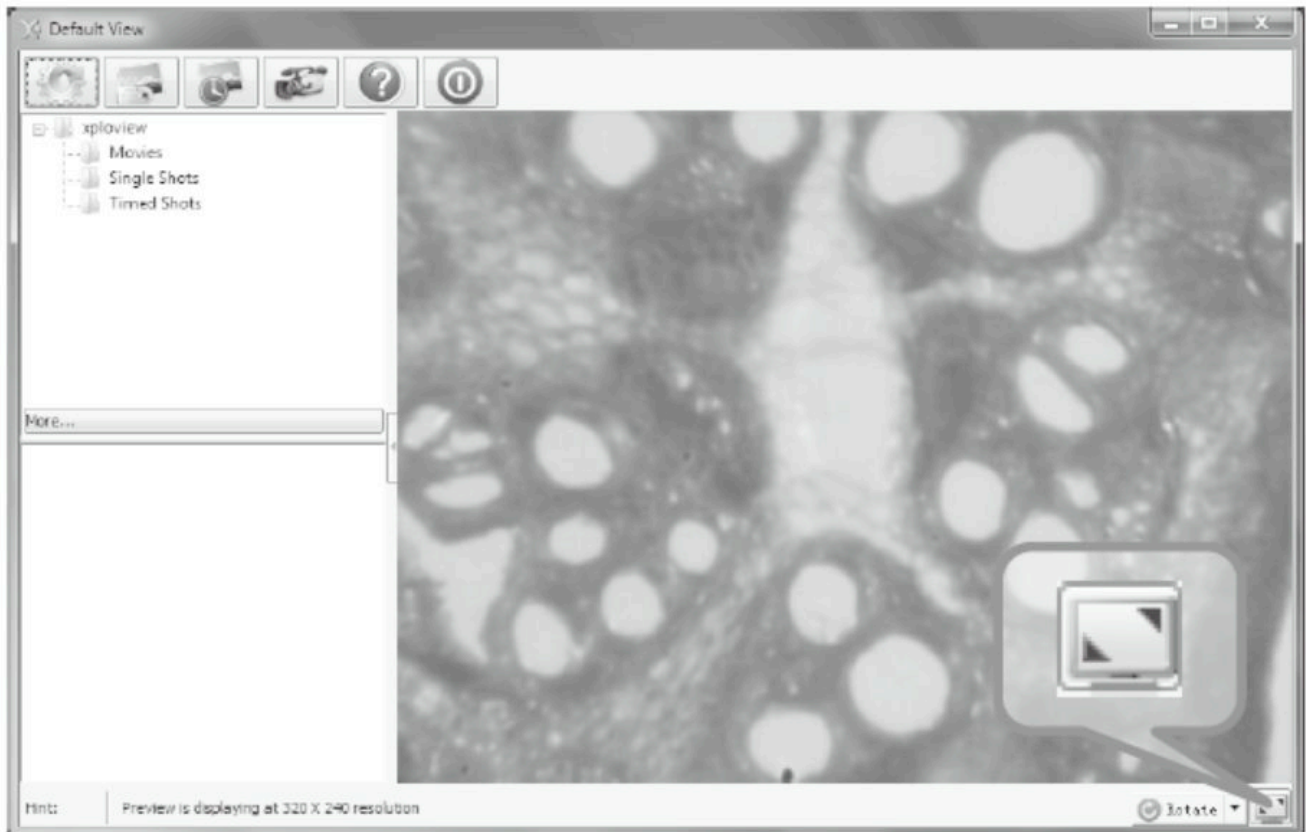
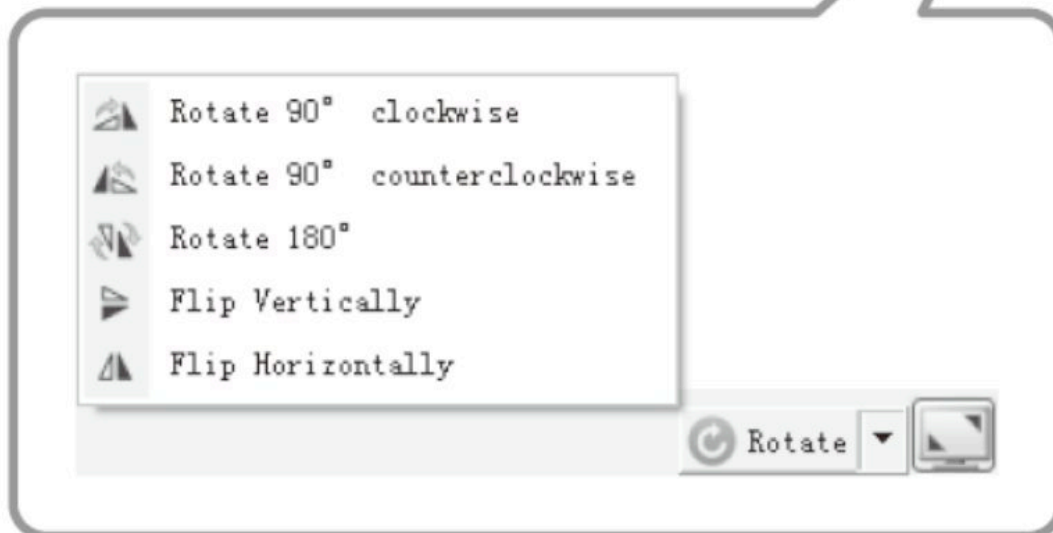

Systemeinstellungenmenü

Wenn die xploview-Software das erste Mal gestartet wird, werden die Standardeinstellungen geladen. Sie können diese Einstellungen manuell im Systemeinstellungenmenü ändern.

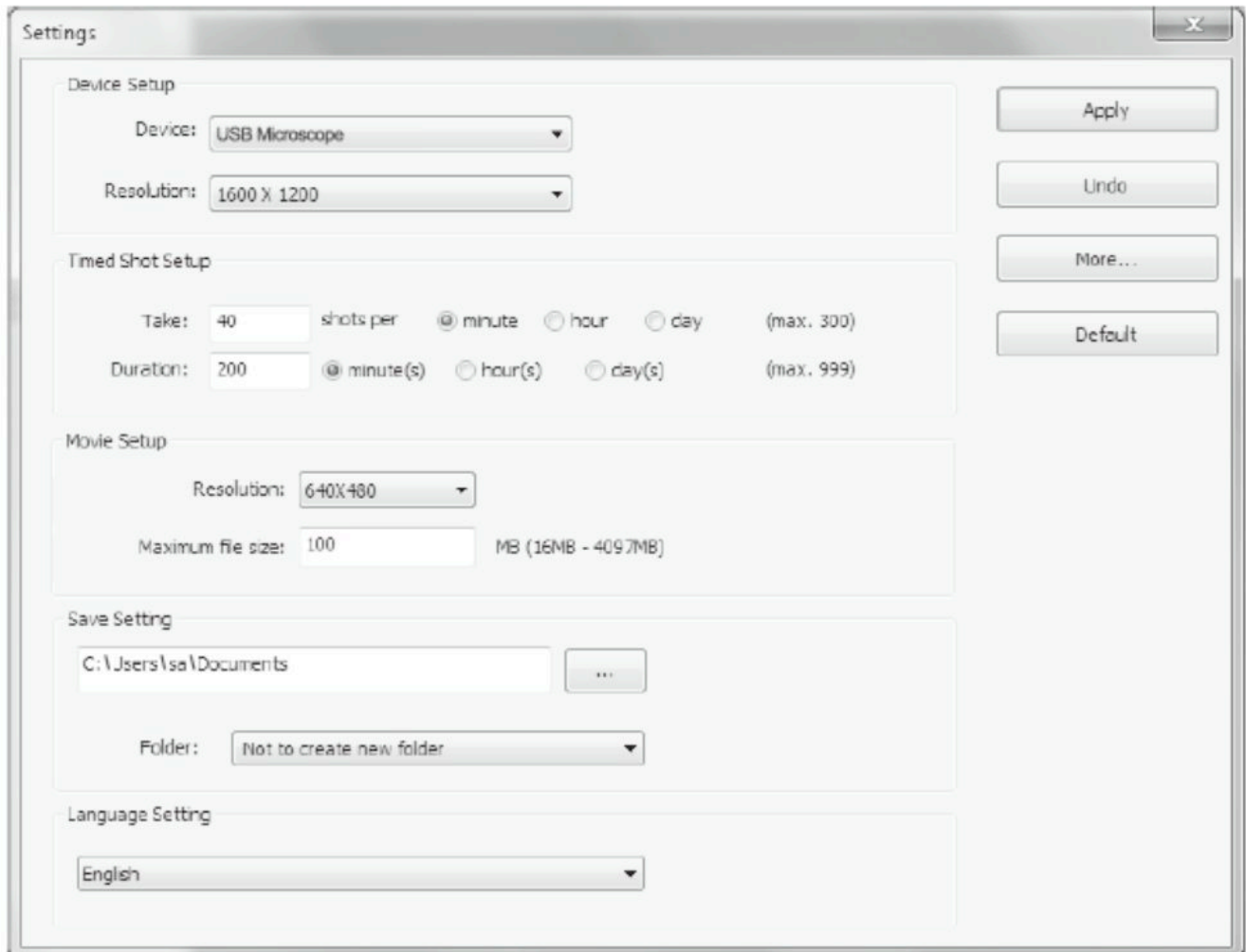

Geräte-Setup

Wenn das von dem digitalen Mikroskop erfasste Bild nicht standardmäßig angezeigt wird, können Sie dies ändern, indem Sie es aus dem Dropdown-Menü „Device“ auswählen.

Die Auflösung der erfassten Bilder kann in dem Dropdown-Menü „Resolution“ geändert werden.



The screenshot shows a 'Device Setup' panel with two dropdown menus. The first menu is labeled 'Device:' and has 'USB Microscope' selected. The second menu is labeled 'Resolution:' and has '1600 X 1200' selected.

Einrichtung der zeitgesteuerten Aufnahme

Die Häufigkeit und Dauer der automatischen Bilderfassung kann mit dieser Option eingestellt werden.

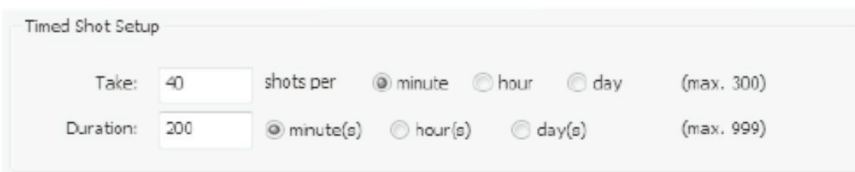

The screenshot shows a 'Timed Shot Setup' panel. It has two rows of controls. The first row is 'Take: 40 shots per' with radio buttons for 'minute' (selected), 'hour', and 'day', and a '(max. 300)' label. The second row is 'Duration: 200' with radio buttons for 'minute(s)' (selected), 'hour(s)', and 'day(s)', and a '(max. 999)' label.

Film-Einrichtung

Die Auflösung von Videoaufnahmen kann in dem Menü „Resolution“ geändert werden. Sie können ebenfalls für jedes Video eine maximale Dateigröße festlegen.

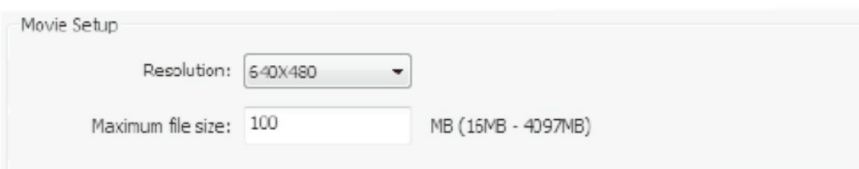

The screenshot shows a 'Movie Setup' panel. It has two rows of controls. The first row is 'Resolution:' with a dropdown menu showing '640X480'. The second row is 'Maximum file size: 100 MB (15MB - 4097MB)' with a text input field containing '100'.

Speicherort einrichten

Mit dieser Option kann der Standard-Speicherort für erfasste Bilder und Videos geändert werden.

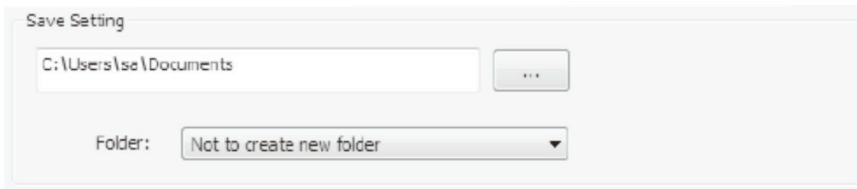

The image shows a 'Save Setting' dialog box. It features a text input field containing the path 'C:\Users\se\Documents' and a button with three dots to its right. Below this, there is a label 'Folder:' followed by a dropdown menu currently set to 'Not to create new folder'.

Spracheinstellung

Mit dieser Option kann die Standardsprache der xploview-Software geändert werden.

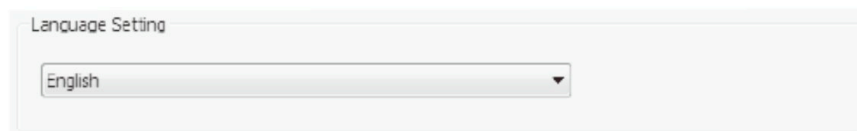

The image shows a 'Language Setting' dialog box. It contains a single dropdown menu with 'English' selected.

Erweiterte Einstellungen

Wenn Sie auf der rechten Seite des Systemeinstellungenmenüs auf die Schaltfläche „More...“ klicken, können Sie alle Bildeinstellungen manuell anpassen. Beachten Sie, dass die verfügbaren Einstellungen je nach Betriebssystem unterschiedlich sein können.

Windows-basierter PC

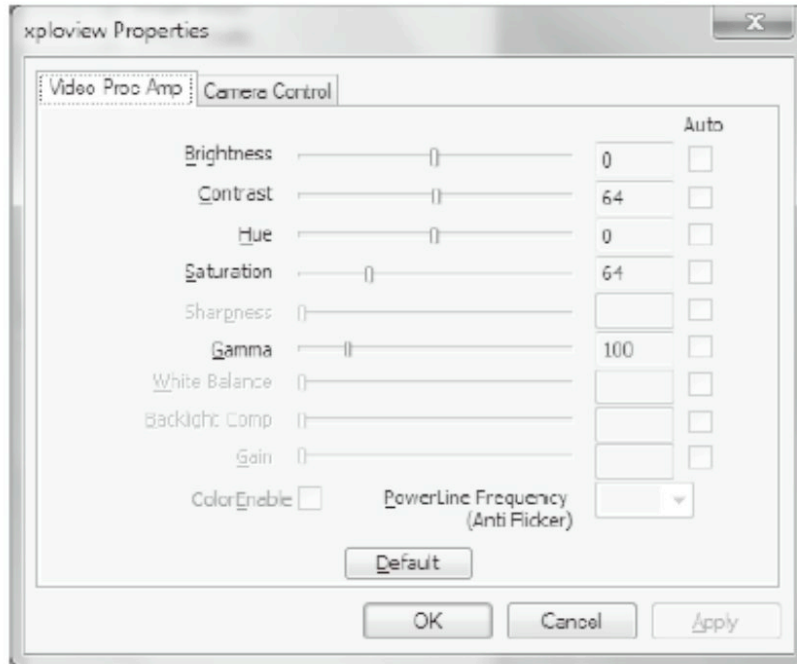

Mac OS-basierter PC

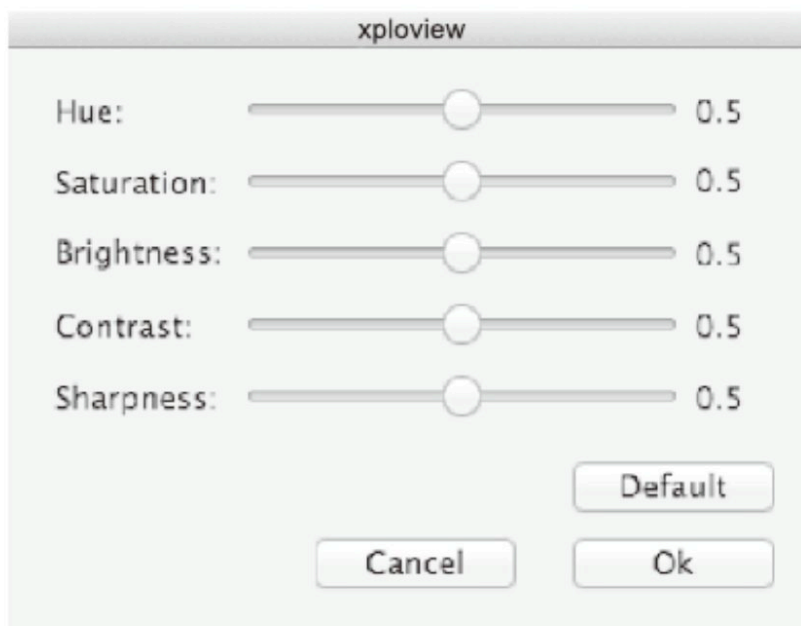

Gespeicherte Dateien

Sie können den Ordner, in dem Ihre Dateien gespeichert werden, in der geöffneten xploview-Anwendungssoftware ausfindig machen, indem Sie auf die Schaltfläche „More...“ auf der linken Seite des Hauptfensters der Software klicken.

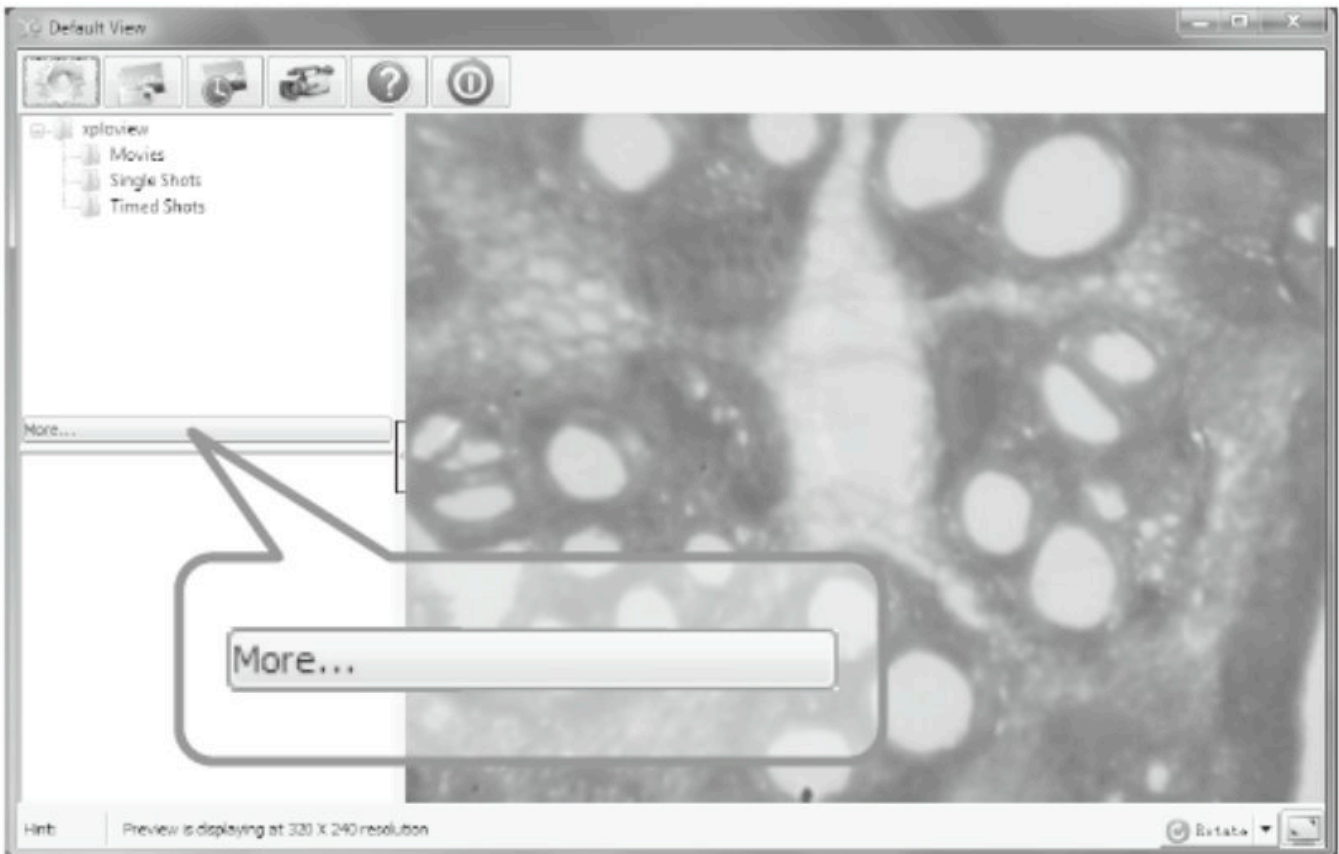

Deinstallieren der xploview-Software

Windows-basierter PC

Wählen Sie aus dem Startmenü „Deinstallieren“ (Start > Alle Programme > xploview > deinstallieren).

Mac OS-basierter PC

Ziehen Sie das Symbol der xploview-Anwendung aus dem Ordner „Anwendungen“ in den „Papierkorb“.

FCC-Konformitätserklärung (nur USA)

Dieses Gerät erfüllt den Teil 15 der FCC-Bestimmungen. Der Betrieb unterliegt den folgenden zwei Bedingungen: (1) Dieses Gerät darf keine schädlichen Störungen erzeugen, und (2) dieses Gerät muss Störungen von außen akzeptieren, einschließlich solcher Störungen, die einen unerwünschten Betrieb verursachen.

Änderungen, die nicht ausdrücklich von der für die Konformität verantwortlichen Partei genehmigt wurden, können zur Nichtigkeit der Betriebserlaubnis des Anwenders für dieses Gerät führen.

Dieses Gerät wurde getestet und entspricht den Bestimmungen für Digitalgeräte Klasse B in Übereinstimmung mit den FCC Richtlinien, Abschnitt 15. Diese Bestimmungen wurden erlassen, um einen angemessenen Schutz gegen nachteilige Störungen bei Heiminstallationen zu gewährleisten. Dieses Gerät erzeugt, verwendet und emittiert möglicherweise Energie auf Funkfrequenzen, die bei unsachgemäßer Installation und Verwendung oder bei Nichtbeachtung dieser Anleitung Störungen des Funkverkehrs verursachen kann. Es besteht indes keinerlei Garantie, dass es bei bestimmten Installationen nicht zu Störungen kommen kann. Falls dieses Gerät Funkstörungen beim Radio- oder Fernsehempfang verursacht, was Sie feststellen können, indem Sie das Gerät aus- und wieder einschalten, versuchen Sie, die Störung durch eine der folgenden Maßnahmen zu beheben:

- Richten Sie Ihre Antenne neu aus oder setzen Sie sie um.
- Vergrößern Sie den Abstand zwischen diesem Gerät und dem Empfänger.
- Schließen Sie das Gerät an eine Steckdose in einem Stromkreis an, an den der Empfänger nicht angeschlossen ist.
- Wenden Sie sich an den Händler oder einen erfahrenen Radio- und Fernsehtechniker für weitere Empfehlungen.

Rechtliche Information

Dieses Dokument ist ohne jegliche Gewährleistung veröffentlicht. Auch wenn die Angaben nach bestem Wissen und Gewissen korrekt sind, können sie Fehler und Ungenauigkeiten enthalten. Der Hersteller oder sein Distributor sind in keinem Fall für Neben- oder Folgeschäden haftbar, einschließlich, jedoch nicht beschränkt auf, entgangenen Gewinn oder kommerzielle Verluste, die aus der Nutzung der in diesem Dokument enthaltenen Informationen entstehen können.

Alle Rechte vorbehalten. Mac, Mac OS und OS X sind Marken von Apple Inc., eingetragen in den USA und anderen Ländern. Windows ist eine eingetragene Marke von Microsoft Corporation in den Vereinigten Staaten und anderen Ländern. Alle anderen Marken sind Eigentum ihrer jeweiligen Inhaber.

reflecta[®]

DigiMicroscope Vario

Instruction manual
for xploview v 3.2

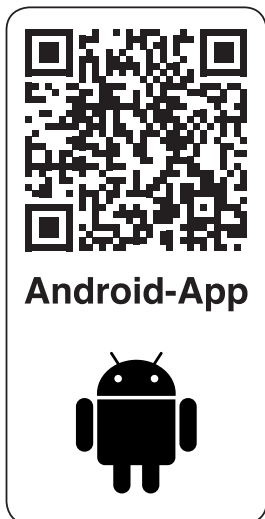
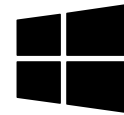

DE

EN

FR

ES

IT

NL

EN

CONTENTS

BEFORE USE	4	USING THE XPLOVIEW SOFTWARE	16
Important information	4	Button menu	16
Care and maintenance	4	Full screen viewing	17
Warning	4	Image rotation / flip	18
Product description	5	System settings menu	19
Computer requirements	5	Device setup	20
		Timed shot setup	20
		Movie setup	20
		Save setting	21
		Language setting	21
		Advanced settings	22
		Saved files	23
		Uninstalling the xploview software	23
PRODUCT AT A GLANCE	6		
Package contents	6		
Product overview	7		
Product specification	8		
GETTING STARTED	9		
Software installation	9		
Connecting the device	10		
Starting the xploview software	10		
Installing a specimen slide	11		
BASICS	12		
Selecting a light source	12		
Selecting a magnification power	13		
Focusing	14		
Taking a snapshot	15		

BEFORE USE

Important information

Please read this instruction manual carefully before using this product, and retain this instruction for future reference.

Improvements and changes to this text necessitated by typographical errors, or improvements to the software and/or equipments may be made at any time without notice.

Care and maintenance

- Avoid vibration, shock and pressure e.g. dropping the microscope.
- Keep the device dry and protect it from water or vapour.
- Do not leave your device in a place with extreme high or low temperature.
- Do not touch the device with a wet hand as it may damage the device, or cause an electric shock to the user.
- Do not use or store the device in dusty, dirty areas as its moving parts may be damaged.
- Do not use harsh chemicals, cleaning solvents or strong detergents to clean the device. Wipe it with a soft cloth slightly dampened in a mild soap-and-water solution.

Warning

- Do not place the lighted digital microscope upon the eye, doing so may cause permanent eye damage.
- Do not attempt to open or dismantle the digital microscope.

Product description

- This product differs from a traditional optical microscope such that, instead of looking through an eyepiece, magnified image or live video is displayed on the computer monitor via a USB connection.
- This product has an integrated object turret carrying six different object lenses. When viewing the image on a 17" monitor, this product can magnify specimens at 100x, 200x, 300x, 400x, 500x and 600x. The magnification is dependent on the size of the computer monitor – the larger the monitor, the higher the magnification.
- Snapshot of the specimens can be captured using the snapshot button located on the top of the device. Live videos and snapshots can also be captured and stored on the computer using the software provided.

Computer requirements

Windows based PC

Compatible operating systems

Windows 10 (32 bit or 64 bit)
Windows 8 (32 bit or 64 bit)
Windows 7 (32 bit or 64 bit)
Windows Vista (32 bit or 64 bit)
Windows XP SP2, SP3

USB

USB 2.0

Mac OS based PC

Compatible operating systems

Mac OS X 10.5.6 - Mac OS X 10.11.x

USB

USB 2.0

PRODUCT AT A GLANCE

Package contents

Digital microscope with USB cable

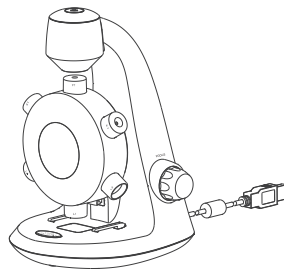

Installation CD

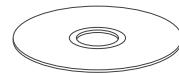

Blank specimen slides x3
Prepared slide with cotton swatch

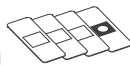

User manual



Tweezers

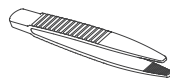

Dropper



Blank specimen slides cover x6



Product overview

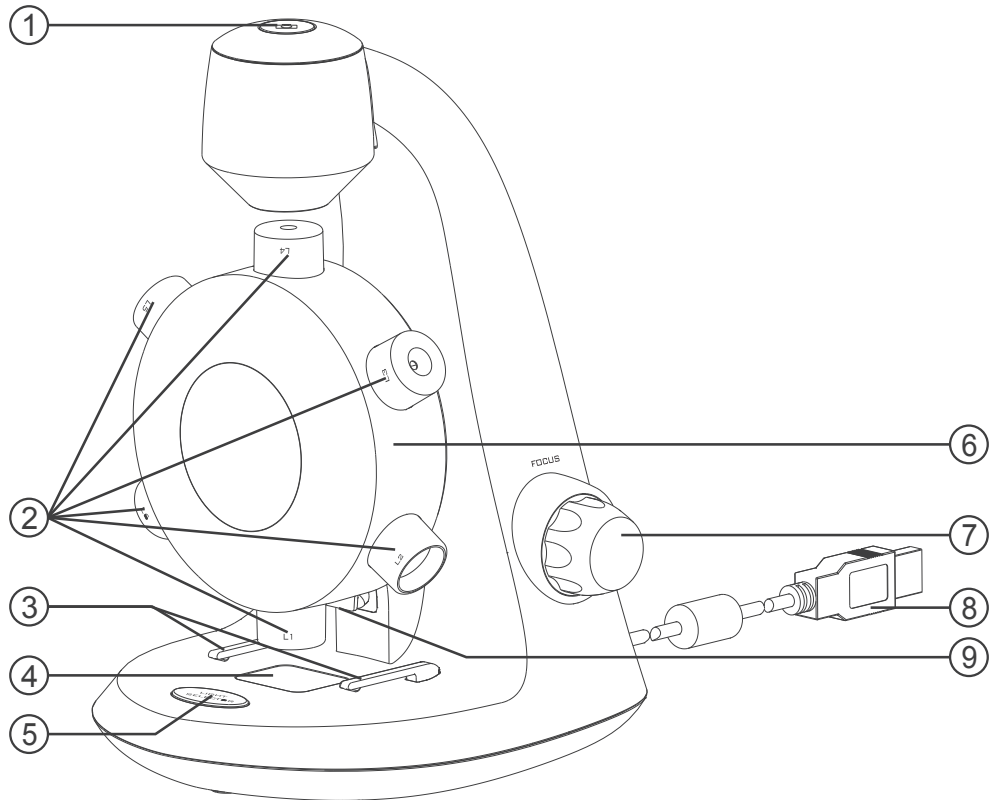

1. Snapshot button
2. Objectives
3. Specimen slide clip
4. Specimen stage
5. Light selector switch
6. Objectives turret
7. Focusing knob
8. USB cable
9. LED

Product specification

Connection type	USB 2.0
Effective observation area	L1 = 3.6 x 2.7mm L2 = 1.8 x 1.4mm L3 = 1.2 x 0.9mm L4 = 0.9 x 0.7mm L5 = 0.7 x 0.5mm L6 = 0.6 x 0.45mm
Magnification power (viewing on a 17 monitor)	L1 = 100x L2 = 200x L3 = 300x L4 = 400x L5 = 500x L6 = 600x
Illumination	LED
Power supply	5V \Rightarrow 250mA (via USB)
Sensor	CMOS
Maximum snapshot resolution	1600 x 1200 pixels (UXGA)
Maximum video capturing resolution	640 x 480 pixels (VGA)
Size	130mm x 154mm x 208mm
Weight	369 grams



GETTING STARTED

Software installation

Windows based PC

- Insert the supplied application CD to the CD-ROM of the computer.
- Double click the "xploview v3.2.xx.exe" icon <  > located on the driver CD.
- Follow the xploview setup wizard to install the application software for the digital microscope.

Mac OS based PC

- Insert the supplied application CD to the CD-ROM of the computer.
- Double click the "xploview v3.2.xx.dmg" icon <  > located on the driver CD.
- Drag the xploview icon <  > into the Applications folder.

Connecting the device

Connect the device to the computer using the USB cable provided.

Starting the xploview software

Windows based PC

The xploview software can be launched by double clicking the xploview icon <  > from the desktop, or from the start menu.

Mac OS based PC

The xploview software can be launched by double clicking the xploview icon <  > from the Applications menu.

Note

When the device is connected to the computer for the first time, a driver will automatically be installed by Windows or Mac OS. This process could take up to a few minutes.

Each time when the xploview software is started, the device should start up automatically. Otherwise, the device can be selected from the device setup section of the system settings menu.

Installing a specimen slide

Place a prepared specimen slide on the specimen stage and slide it into the specimen slide clips such that the clips hold the specimen slide securely.

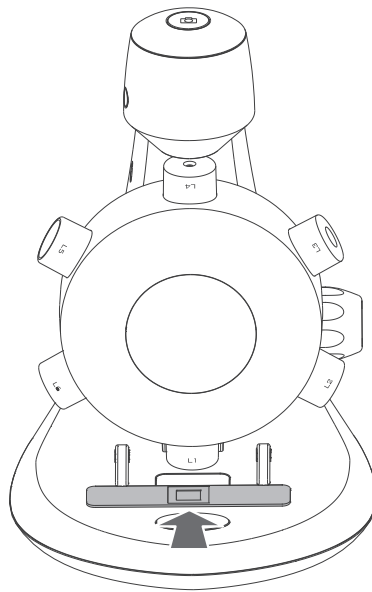

BASICS

Selecting a light source

This digital microscope contains two light sources, one located above the stage and one underneath providing incident and transmitted illumination respectively.

When the device is connected to a computer, on executing the provided software, one of the lights will be switched on.

Press the light selector switch once to switch over to the desired illumination system. When quitting the software, the light will switch off automatically.

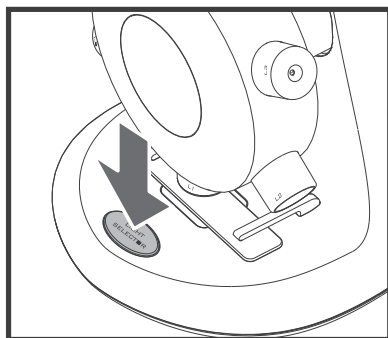

Press once to switch over illumination system

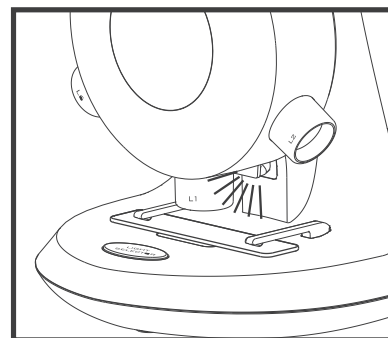

Incident illumination

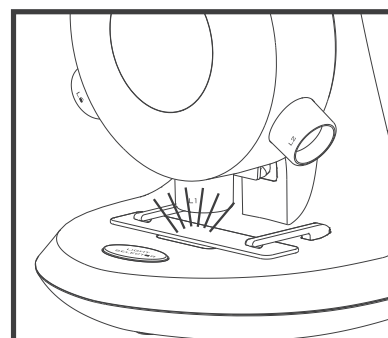

Transmitted illumination

Selecting a magnification power

The objective turret can be rotated both ways – clockwise or anticlockwise.

Taking the least powerful objective, L1, as an example; rotate the objective turret such that L1 is directly on top of the specimen. When the objective is correctly aligned, you will feel a 'click'.

Rotate the object turret to select the desired magnification.

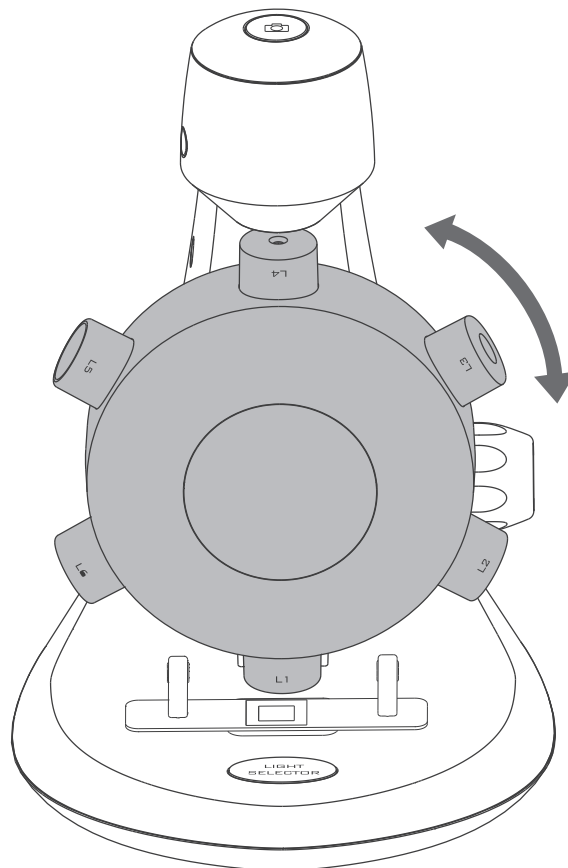

Focusing

Rotate the focusing knob clockwise or anticlockwise until the image is sharp.

Note: Please make sure that the objective is clear from obstacles and does not hit the specimen slide while lowering the objectives turret during focusing.

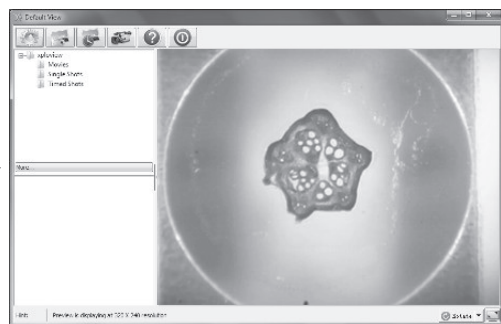
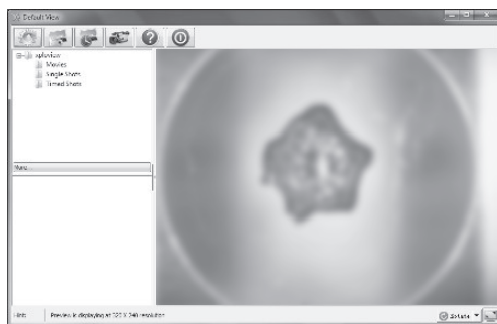
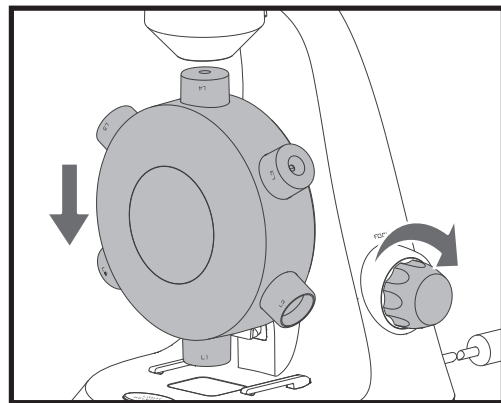
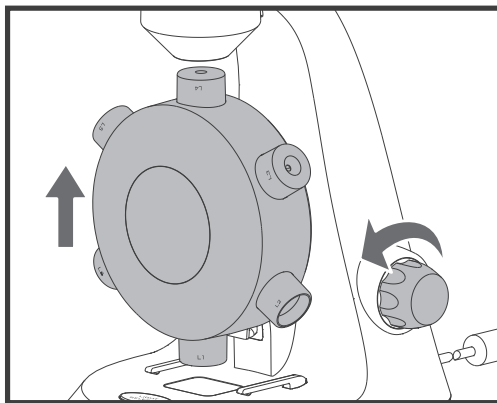

Taking a snapshot

Press the snapshot button to take a snapshot.

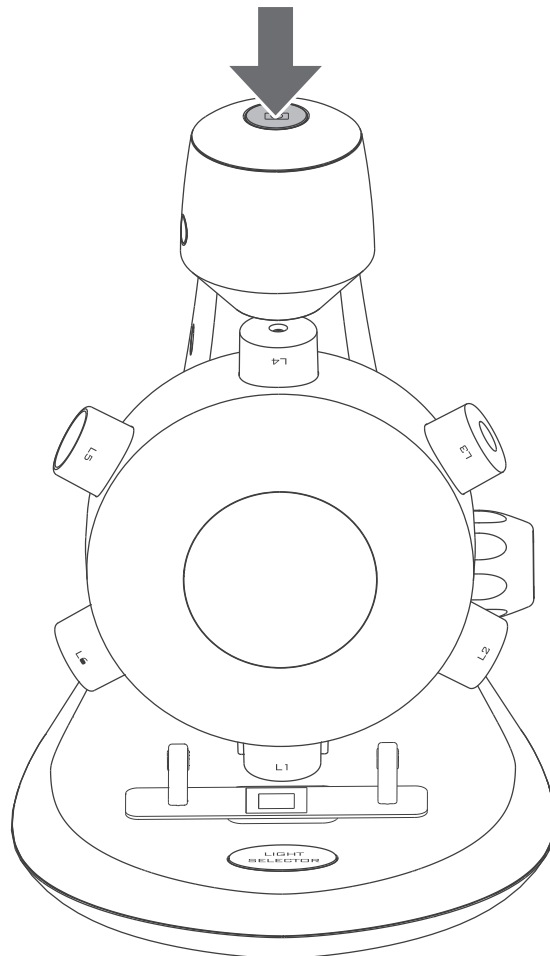

USING THE XPLOVIEW SOFTWARE

Button menu

The icons on the button menu :



Open **System Settings Menu** (see system settings menu on page19).



Capture on screen image.



To start and to stop **Timed Shot**. Images will be captured at a regular interval (see system settings menu on page 20 to adjust frequency and duration).



To start and to stop **Video Recording**.



Information of the application software. This information maybe helpful when updating software.



Shut down the application software.

Full screen viewing

To activate the full screen mode, click the full screen button <  > located on the bottom right corner of the xploview application software window.

To exit full screen mode, either double click on the screen, or press the "Esc" button on the keyboard.

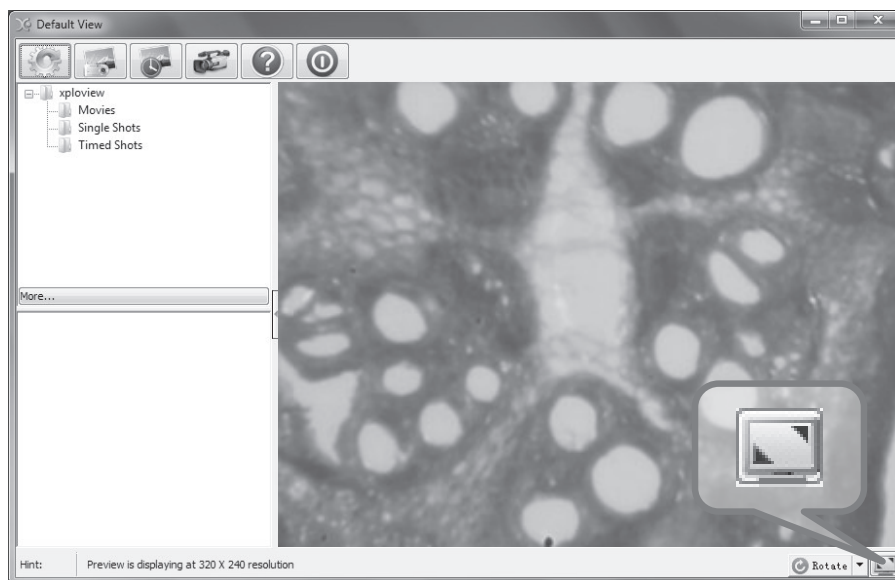
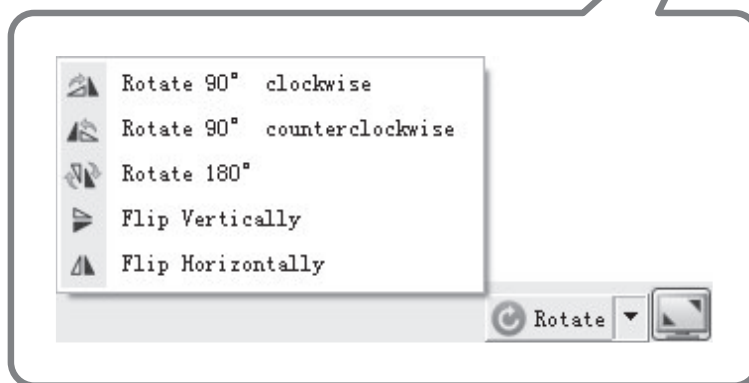
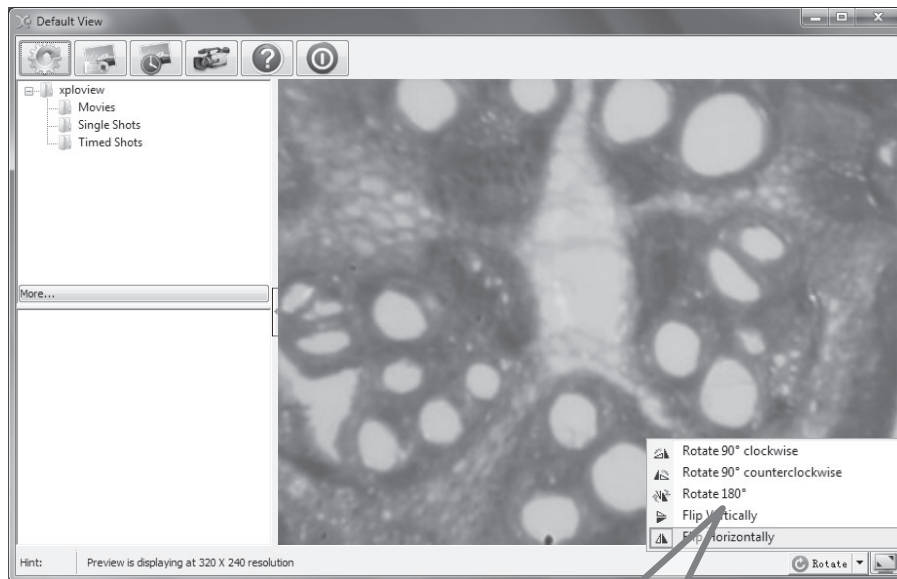

Image rotation / flip

Click <  Rotate > button to rotate or flip the image.



System settings menu

The first time the xploview software is started, the default settings will be loaded, you may change these settings manually in the system settings menu.

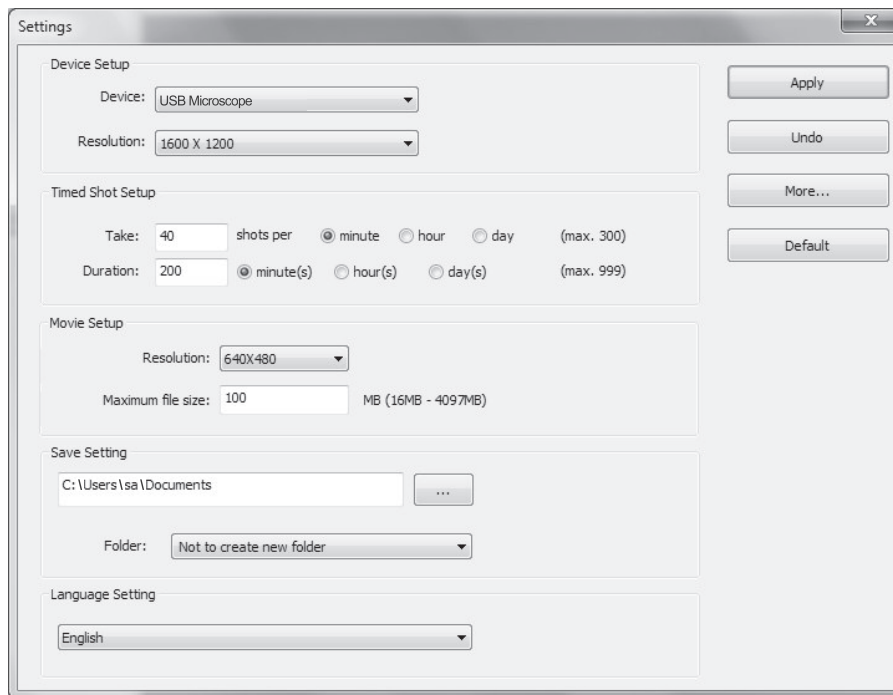

Device setup

If the image captured by the digital microscope was not displayed by default, you can change this by selecting it from the "Device" drop-down menu.

The resolution of images you capture can be changed from the "Resolution" drop-down menu.

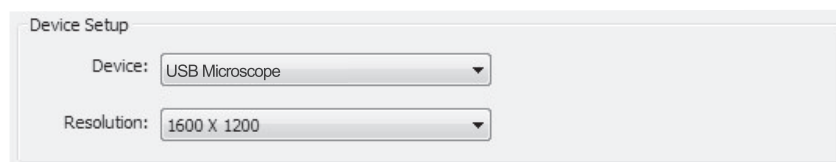

The screenshot shows a panel titled "Device Setup" with two dropdown menus. The first is labeled "Device:" and is set to "USB Microscope". The second is labeled "Resolution:" and is set to "1600 X 1200".

Timed shot setup

The frequency and duration of automatic images capture can be adjusted under this option.

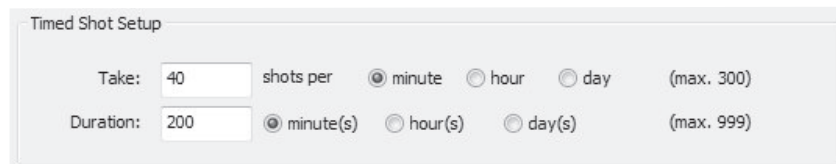

The screenshot shows a panel titled "Timed Shot Setup" with two rows of controls. The first row is "Take: 40" with a text input field, followed by "shots per" and three radio buttons: "minute" (selected), "hour", and "day". A "(max. 300)" label is to the right. The second row is "Duration: 200" with a text input field, followed by three radio buttons: "minute(s)" (selected), "hour(s)", and "day(s)". A "(max. 999)" label is to the right.

Movie setup

The resolution of videos you record can be changed from the "Resolution" menu. You can also set a maximum file size for each video.

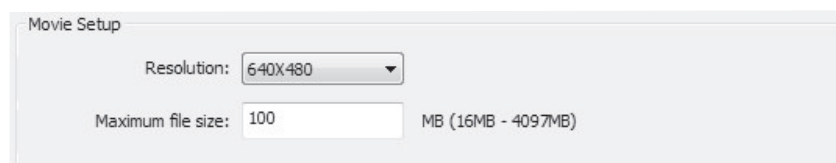

The screenshot shows a panel titled "Movie Setup" with two controls. The first is "Resolution:" with a dropdown menu set to "640X480". The second is "Maximum file size:" with a text input field set to "100" and the text "MB (16MB - 4097MB)" to its right.

Save setting

The default location for captured images or videos can be changed under this option.

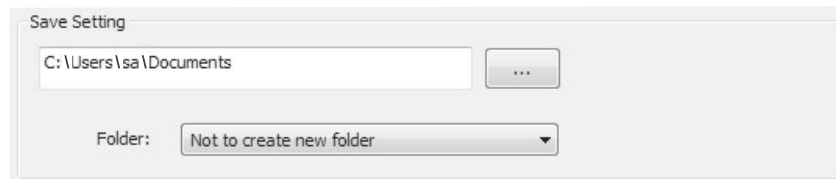

Language setting

The language of the xploview software can be changed under this option.

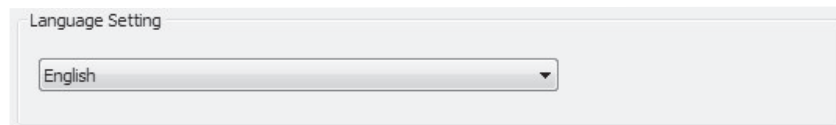

Advanced settings

By clicking the "More..." button on the right of the system settings menu, you will be able to manually adjust all of the image settings. Note that the settings available may be different, depending on your operating system.

Windows based PC

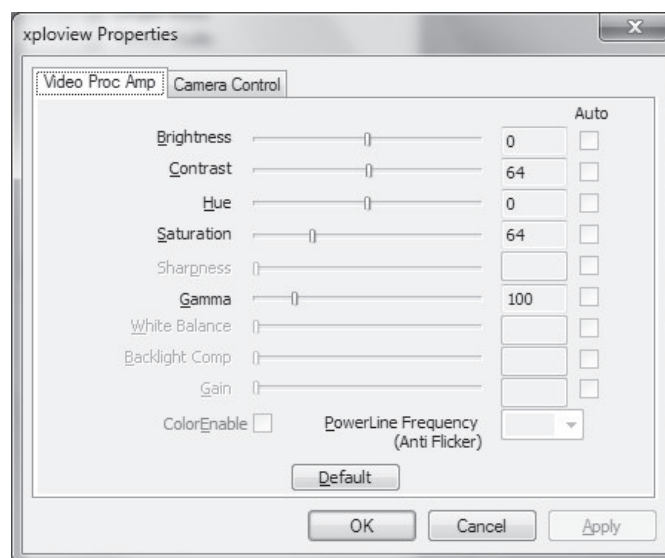

Mac OS based PC

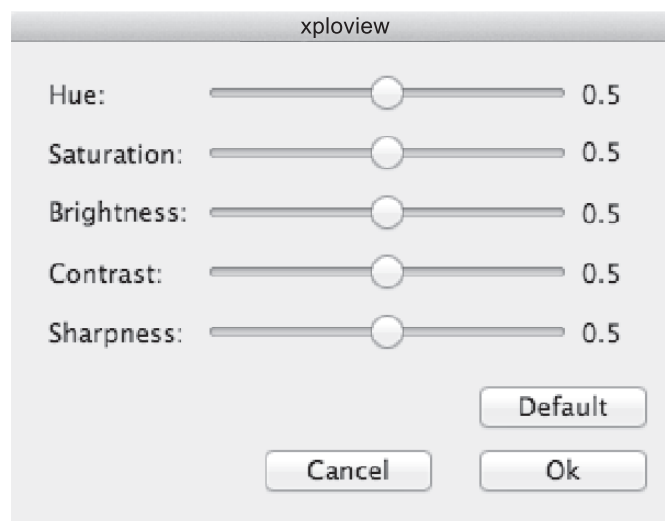

Saved files

With the xploview application software opened, you can locate the saved files folder by clicking the "More..." button located on the left of the main software window.

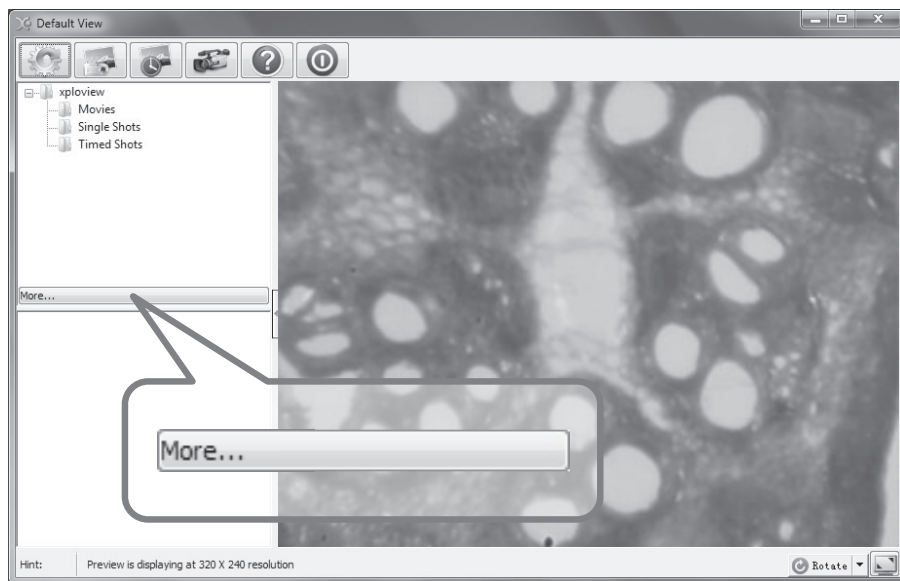

Uninstalling the xploview software

Windows based PC

Select "Uninstall" from the start menu (Start > All Programs > xploview > Uninstall).

Mac OS based PC

Drag the xploview application icon from the "Applications" folder to "Trash".

FCC compliance statement (United States only)

This device complies with part 15 of the FCC Rules. Operation is subject to the following two conditions: (1) This device may not cause harmful interference, and (2) this device must accept any interference received, including interference that may cause undesired operation.

Changes or modifications not expressly approved by the party responsible for compliance could void the user's authority to operate this device.

This device has been tested and found to comply with the limits for a Class B digital device, pursuant to part 15 of the FCC Rules. These limits are designed to provide reasonable protection against harmful interference in a residential installation. This device generates, uses and can radiate radio frequency energy and, if not installed and used in accordance with the instructions, may cause harmful interference to radio communications. However, there is no guarantee that interference will not occur in a particular installation. If this device does cause harmful interference to radio or television reception, which can be determined by turning the equipment off and on, the user is encouraged to try to correct the interference by one or more of the following measures:

- Reorient or relocate the receiving antenna.
- Increase the separation between the equipment and receiver.
- Connect the device into an outlet on a circuit different from that to which the receiver is connected.
- Consult the dealer or an experienced radio/TV technician for help.

Legal information

This document is published without any warranty. While the information provided is believed to be accurate, it may include errors or inaccuracies. In no event shall the manufacturer or its distributors be liable for incidental or consequential damages of any nature, including but not limited to loss of profits or commercial loss, arising out of the use of the information in this document.

All rights reserved. Mac, Mac OS and OS X are trademarks of Apple Inc., registered in the U.S. and other countries. Windows is a registered trademark of Microsoft Corporation in the United States and other countries. All other trademarks and brands are property of their respective owners.

reflecta[®]

DigiMicroscope Vario

Guide d'utilisation
pour xploview v 3.2

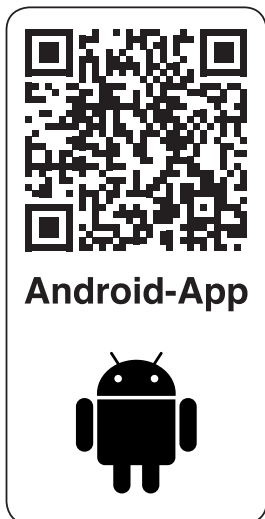
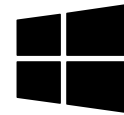

DE

EN

FR

ES

IT

NL

FR

SOMMAIRE

AVANT L'UTILISATION	4
Informations importantes	4
Entretien et nettoyage	4
Avertissement	4
Description du produit	5
Configuration de l'ordinateur requise	5
DESCRIPTION SUCCINCTE DU PRODUIT	6
Contenu de l'emballage	6
Description du produit	7
Caractéristiques du produit.....	8
Mise en route	9
Installation du logiciel	9
Connexion de l'appareil	10
Démarrage du logiciel xploview	10
Installation d'une lame porte-objets	11
ÉLÉMENTS ESSENTIELS	12
Sélection d'une source de lumière.....	12
Sélection d'un facteur de grossissement	13
Mise au point.....	14
Prendre un instantané	15
UTILISATION DU LOGICIEL XPLOVIEW	16
Menu de boutons.....	16
Visualisation en plein écran.....	17
Rotation/Pivotement de l'image	18
Menu paramètres système	19
Configuration de l'appareil	20
Configuration de prises d'images automatiques.....	20
Configuration vidéo	20
Paramètres d'enregistrement.....	21
Paramètres de langue.....	21
Paramètres avancés	22
Fichiers enregistrés	23
Désinstallation du logiciel xploview.....	23

AVANT L'UTILISATION

Informations importantes

Lisez attentivement ce manuel avant d'utiliser l'appareil et le conserver pour toute référence future.

Des améliorations et des modifications peuvent être apportées à tout moment et sans préavis à ce document à cause d'erreurs typographiques ou d'améliorations du logiciel et/ou des équipements.

Entretien et nettoyage

- Évitez toute vibration, choc et pression, ex. faire tomber le microscope.
- Gardez l'appareil au sec et le protéger de l'eau et de la vapeur.
- Ne laissez pas l'appareil dans un endroit à températures extrêmes.
- Ne touchez pas l'appareil avec les mains mouillées, cela risque de l'endommager ou de provoquer un choc électrique.
- N'utilisez pas et ne rangez pas l'appareil dans un endroit poussiéreux ou sale, ses pièces mobiles risquent d'en être endommagées.
- N'utilisez pas de produits chimiques corrosifs, des solvants de nettoyage ou des détergents forts pour nettoyer l'appareil. Essuyez l'appareil avec un chiffon doux légèrement imbibé d'une solution d'eau savonneuse douce.

Avertissement

- Ne dirigez pas le microscope numérique allumé vers les yeux, cela peut causer des lésions oculaires permanentes.
- Ne tentez pas d'ouvrir ou de démonter le microscope numérique.

Description du produit

- Ce microscope numérique diffère d'un microscope optique traditionnel, au lieu de regarder à travers un oculaire, l'image ou la vidéo agrandie est affichée sur l'écran d'un ordinateur connecté via USB.
- Cet appareil comprend une tourelle portant six objectifs différents. Lors de l'affichage de l'image sur un écran 17", cet appareil peut agrandir les objets jusqu'à 100, 200, 300, 400, 500 et 600 fois. Le facteur de grossissement dépend de la taille de l'écran utilisé, plus l'écran est grand plus le grossissement est élevé.
- Les instantanés d'objets peuvent être capturés à l'aide de la touche Snapshot (instantané) située en haut de l'appareil. Les vidéos en direct et les instantanés peuvent également être capturés et enregistrés sur l'ordinateur en utilisant le logiciel fourni.

Configuration de l'ordinateur requise

PC Windows

Systèmes d'exploitation compatible

Windows 10 (32 ou 64 bits)

Windows 8 (32 ou 64 bits)

Windows 7 (32 ou 64 bits)

Windows Vista (32 ou 64 bits)

Windows XP SP2, SP3

USB

USB 2.0

PC Mac OS

Systèmes d'exploitation compatible

Mac OS X 10.5.6 - Mac OS X 10.11.x

USB

USB 2.0

DESCRIPTION SUCCINCTE DU PRODUIT

Contenu de l'emballage

Microscope numérique avec
câble USB

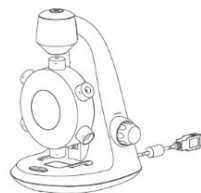

Trois lames porte-objets
vierges Lame préparée avec
du coton



Pinces à épiler

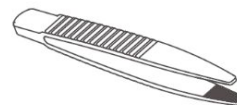

6 lamelles couvre objets
vierges

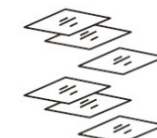

CD d'installation



Guide
d'utilisation



Compte-gouttes



Description du produit

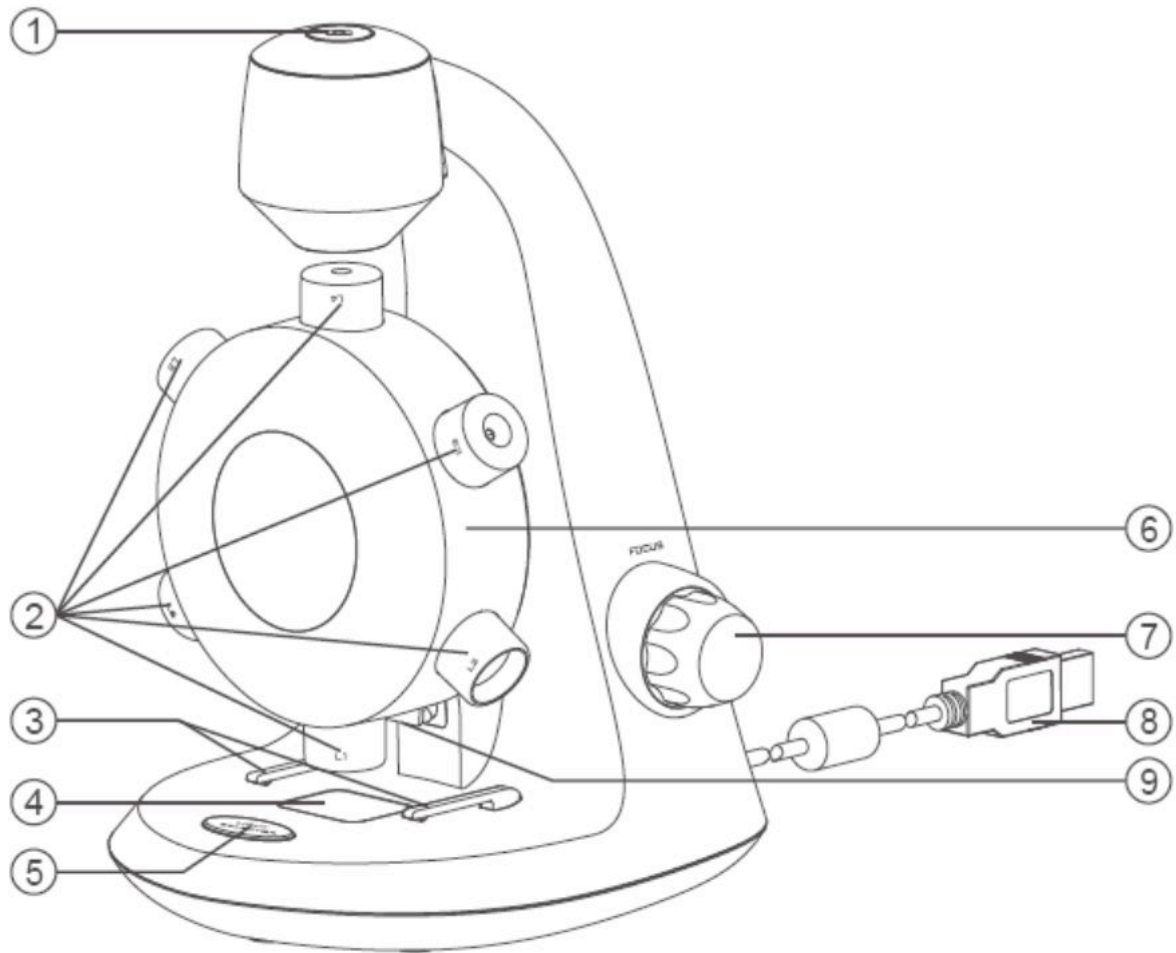

1. Touche Snapshot (instantané)
2. Objectifs
3. Pince de lame porte-objets
4. Platine porte-objets
5. Sélecteur de lumière
6. Tourelle porte-objectifs
7. Molette de mise au point
8. Câble USB
9. LED

Caractéristiques du produit

Type de connexion	USB 2.0
Zone d'observation effective	L1 = 3,6 x 2,7 mm L2 = 1,8 x 1,4 mm L3 = 1,2 x 0,9 mm L4 = 0,9 x 0,7 mm L5 = 0,7 x 0,5 mm L6 = 0,6 x 0,45 mm
Facteur de grossissement (visualisation sur écran 17")	L1 = 100 fois L2 = 200 fois L3 = 300 fois L4 = 400 fois L5 = 500 fois L6 = 600 fois
Éclairage	LED
Alimentation	5V $\overline{\text{---}}$ 250mA (via USB)
Capteur	CMOS
Résolution de snapshot maximale	1600 x 1200 pixels (UXGA)
Résolution de capture vidéo maximale	640 x 480 pixels (VGA)
Dimensions	130 mm x 154 mm x 208 mm
Poids	369 grammes



Mise en route

Installation du logiciel

PC Windows

- Insérez le CD d'application fourni dans le lecteur de CD-ROM d'un ordinateur.
- Double-cliquez sur l'icône <  > de « xploview v3.2.xx.exe » situé sur le CD des pilotes.
- Suivez l'assistant d'installation de xploview pour installer le logiciel du microscope numérique.

PC Mac OS

- Insérez le CD d'application fourni dans le lecteur de CD-ROM d'un ordinateur.
- Double-cliquez sur l'icône <  > de « xploview v3.2.xx.dmg » situé sur le CD des pilotes.
- Faites glisser l'icône <  > de xploview dans le dossier Applications.

Connexion de l'appareil

Connectez l'appareil à l'ordinateur en utilisant le câble USB fourni.

Démarrage du logiciel xploview

PC Windows

Le logiciel xploview peut être lancé en double-cliquant sur l'icône < > de xploview situé sur le bureau, ou dans le menu Démarrer.

PC Mac OS

Le logiciel xploview peut être lancé en double-cliquant sur l'icône < > de xploview situé dans le menu Applications.

Remarque

Lorsque l'appareil est connecté à un ordinateur pour la première fois, un pilote sera automatiquement installé par Windows ou Mac OS. Cette opération pourrait prendre quelques minutes.

Chaque fois que le logiciel xploview démarre, l'appareil devrait démarrer automatiquement. Autrement, l'appareil peut être sélectionné dans la section de configuration de l'appareil dans le menu paramètres système.

Installation d'une lame porte-objets

Placez une lame porte-objets préparée sur la platine porte-objets et la faire glisser dans les pinces de lame porte-objets de manière qu'elles la retiennent solidement.

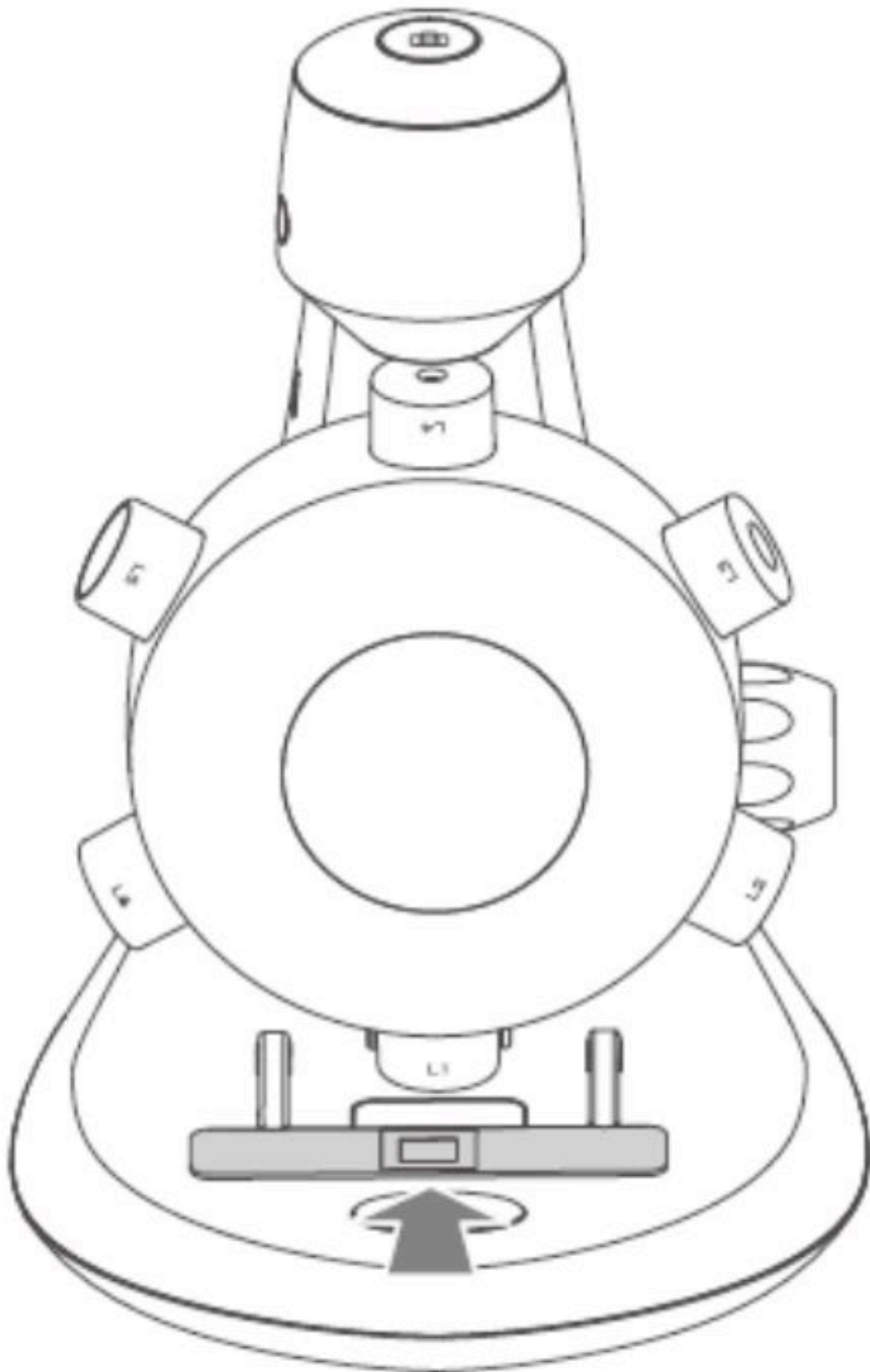

ÉLÉMENTS ESSENTIELS

Sélection d'une source de lumière

Ce microscope numérique comprend deux sources de lumière, l'une située au-dessus de la platine et l'autre en dessous fournissant respectivement une lumière incidente et transmise.

Lorsque l'appareil est connecté à un ordinateur, lors de l'exécution du logiciel fourni, l'une des lumières sera allumée.

Appuyez une fois sur le sélecteur de lumière pour basculer vers le système d'éclairage souhaité. Lorsque vous quittez le logiciel, la lumière s'éteint automatiquement.

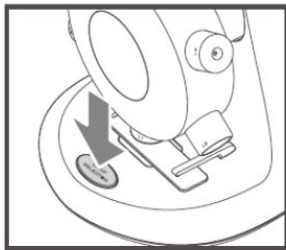

Appuyez une fois pour accéder au système d'éclairage

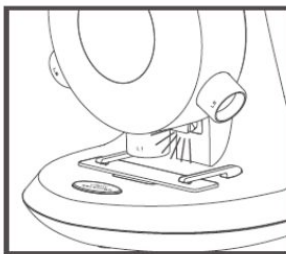

Lumière incidente

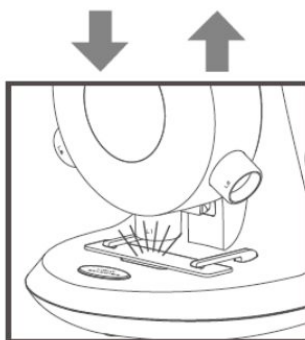

Lumière transmise

Sélection d'un facteur de grossissement

La tourelle porte-objectifs peut être tournée dans les deux sens : horaire et antihoraire.

Prenons le puissant objectif L1 à titre d'exemple; faites tourner la tourelle porte-objectifs de manière que l'objectif L1 soit directement au-dessus de l'échantillon. Lorsque l'objectif est correctement aligné, vous sentirez un « clic ».

Tournez la tourelle porte-objectifs pour sélectionner l'agrandissement souhaité.

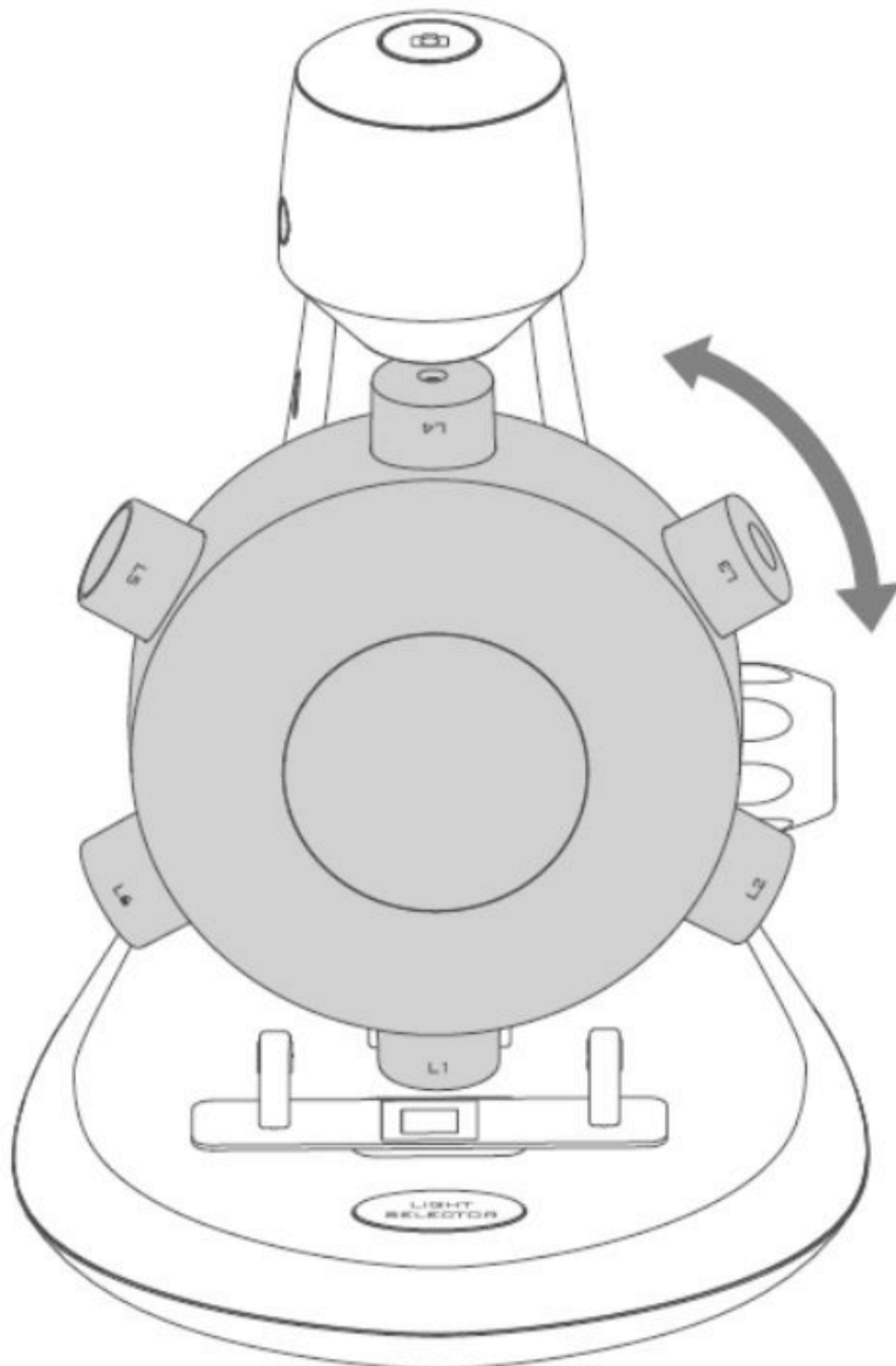

Mise au point

Tournez la molette de mise au point dans le sens horaire ou antihoraire jusqu'à ce que l'image soit nette.

Remarque : En abaissant la tourelle porte-objectifs pendant la mise au point, veillez à ce que l'objectif ne rencontre aucun obstacle et qu'il ne touche pas la lame porte-objets.

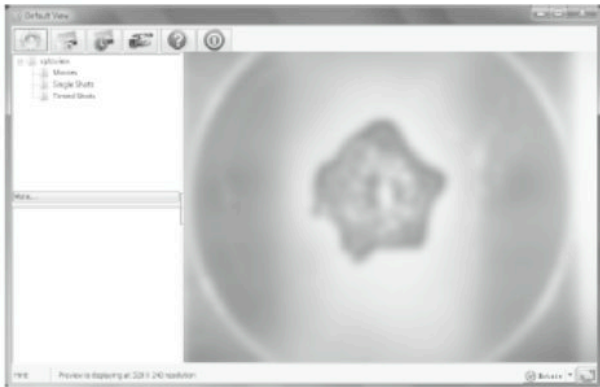
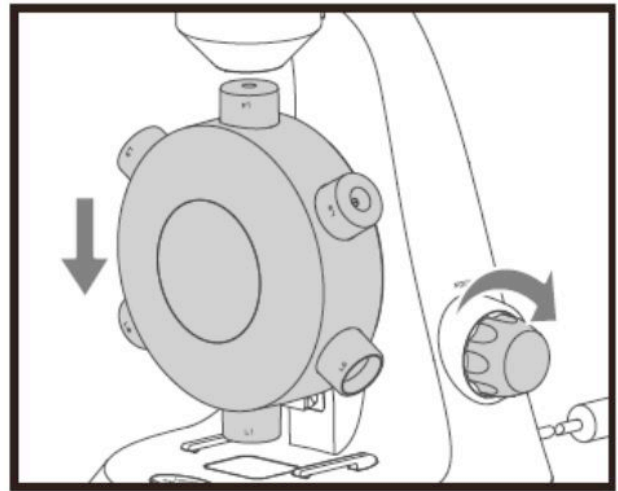
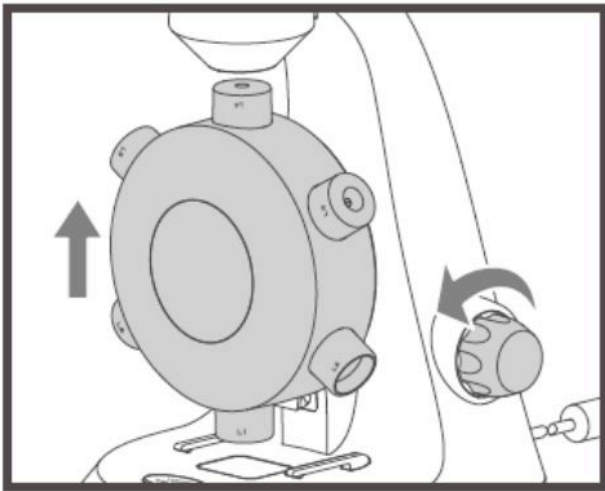

Prendre un instantané

Appuyez sur la touche d'instantané pour prendre un instantané.

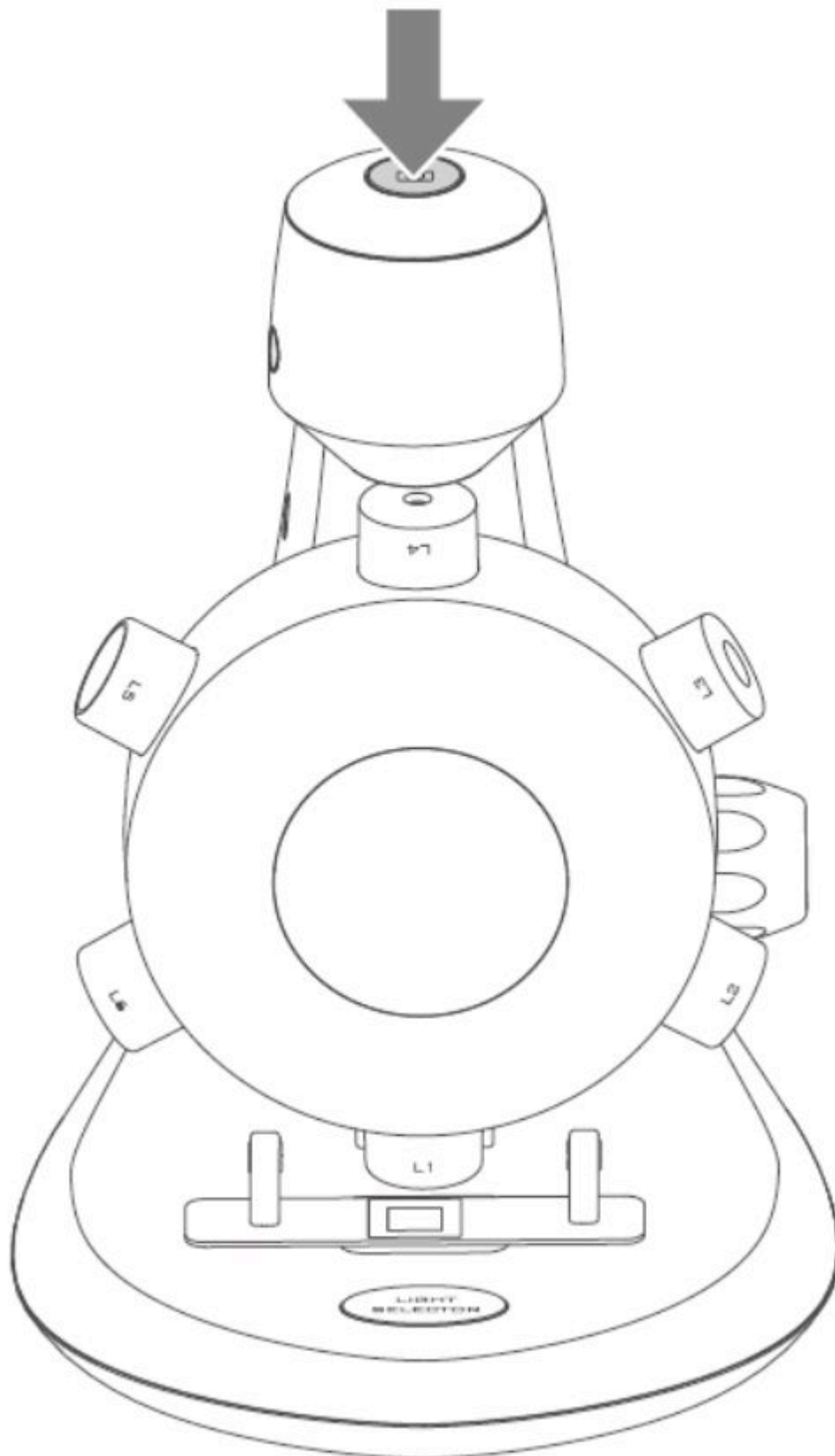

UTILISATION DU LOGICIEL XPLOVIEW

Menu de boutons

Voici les icônes du menu de boutons :



Ouvrez le **menu Paramètres système** (voir menu paramètres système à la page19).



Pour **capturer** une **image** sur l'écran.



Pour démarrer et arrêter une **prise d'images automatique**. Les images seront capturées à intervalle constant (voir menu paramètres système de la page 20 pour régler la fréquence et la durée).



Pour démarrer et arrêter l'**enregistrement vidéo**.



Informations sur le logiciel. Ces informations peuvent être utiles lors de la mise à jour du logiciel.



Pour **arrêter** le logiciel.

Visualisation en plein écran

Pour activer le mode plein écran, cliquez sur le bouton plein écran <  > situé dans le coin inférieur droit de la fenêtre du logiciel xploview.

Pour quitter le mode plein écran, double-cliquez sur l'écran ou appuyez sur la touche «Esc» du clavier.

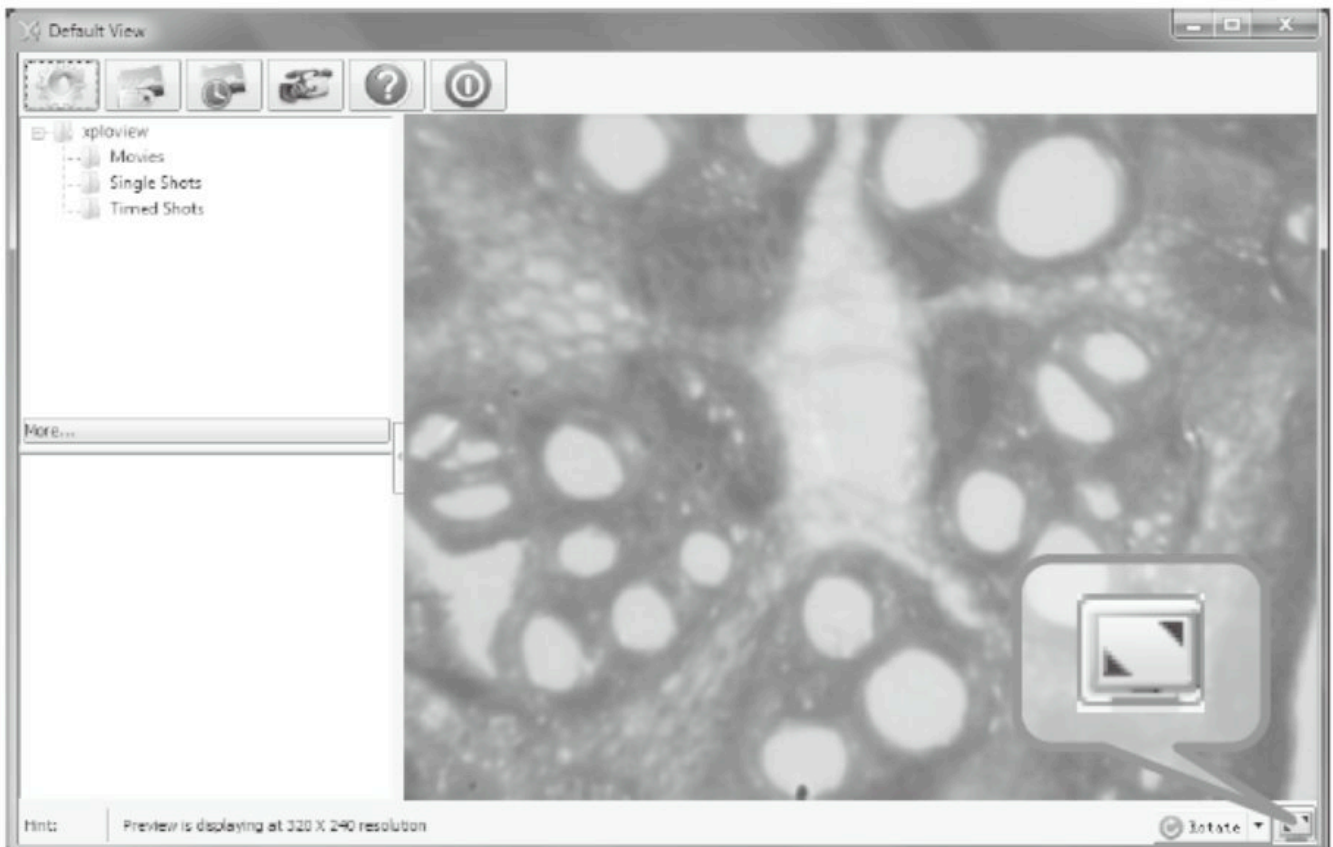

Rotation/Pivotement de l'image

Cliquez sur le bouton  Rotate > pour faire tourner ou pivoter l'image.

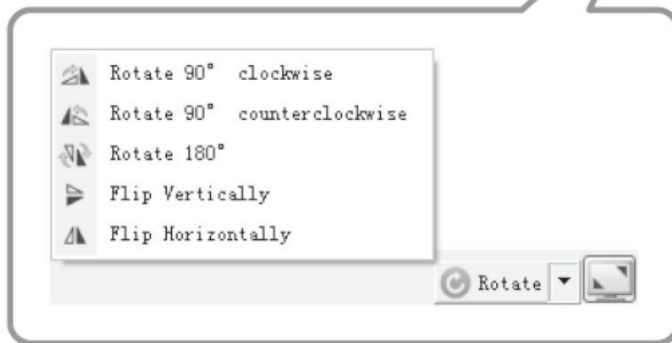

Menu paramètres système

Lors du premier démarrage du logiciel xploview, les paramètres par défaut seront utilisés, vous pouvez modifier ces paramètres manuellement dans le menu paramètres système.

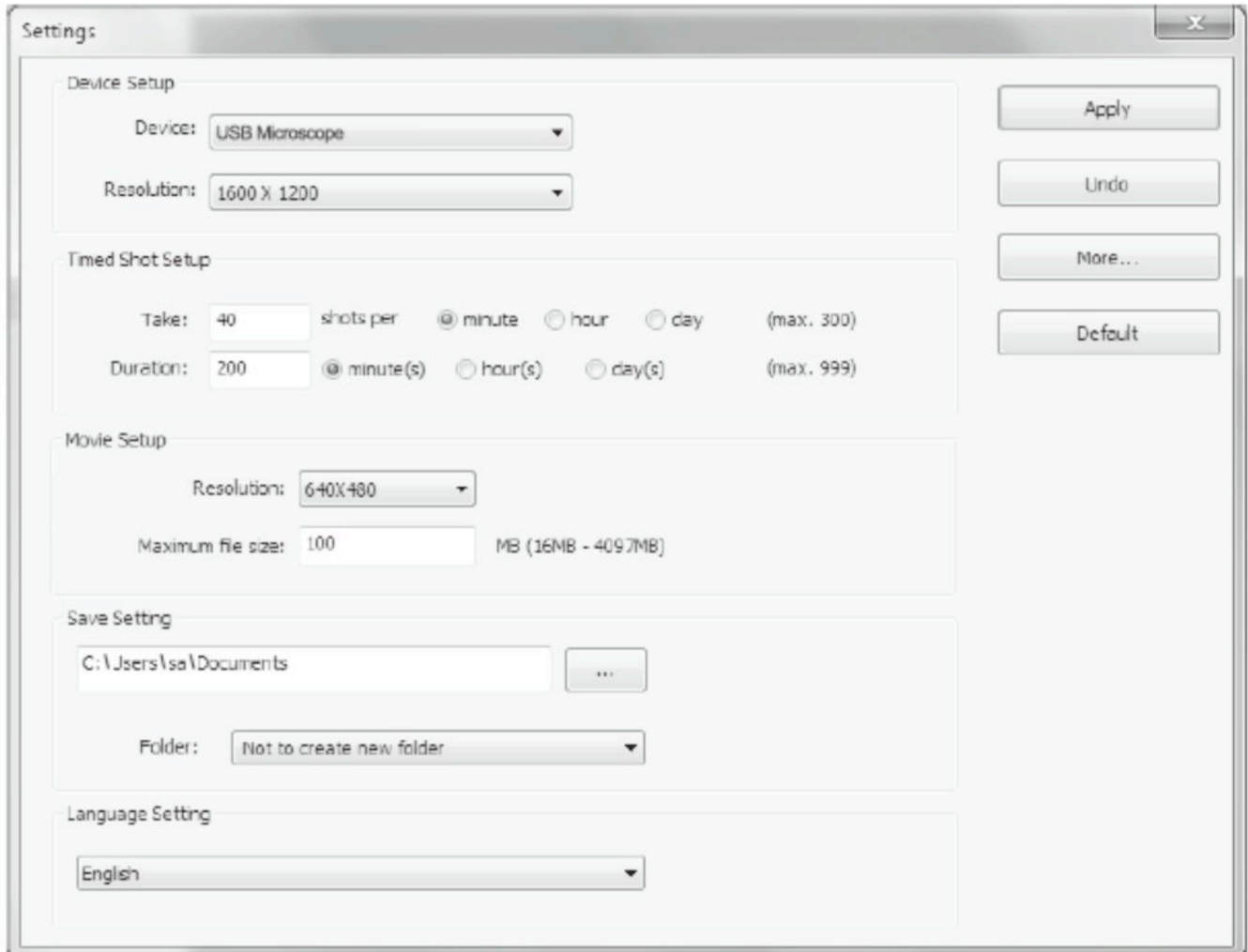

Configuration de l'appareil

Si l'image capturée par le microscope numérique n'a pas été affichée par défaut, vous pouvez changer cela en sélectionnant «Device» dans le menu déroulant.

Vous pouvez modifier la résolution des images que vous capturez dans le menu déroulant «Resolution».



The screenshot shows a 'Device Setup' panel with two dropdown menus. The first menu is labeled 'Device:' and is set to 'USB Microscope'. The second menu is labeled 'Resolution:' and is set to '1600 X 1200'.

Configuration de prises d'images automatiques

Cette option permet de définir la fréquence et la durée des prises d'images automatiques.

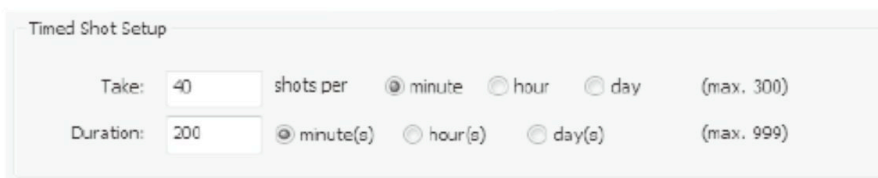

The screenshot shows a 'Timed Shot Setup' panel. It has two rows of controls. The first row is for 'Take:' with a value of '40' and 'shots per' options: 'minute' (selected), 'hour', and 'day', with a '(max. 300)' limit. The second row is for 'Duration:' with a value of '200' and options: 'minute(s)' (selected), 'hour(s)', and 'day(s)', with a '(max. 999)' limit.

Configuration vidéo

Vous pouvez modifier la résolution des vidéos que vous enregistrez dans le menu déroulant «Resolution». Vous pouvez également fixer une taille maximale de fichier pour chaque vidéo.

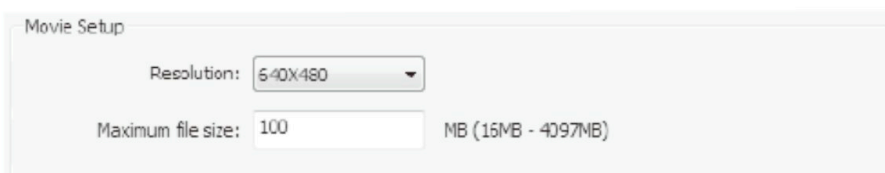

The screenshot shows a 'Movie Setup' panel. It has two controls: a dropdown menu for 'Resolution:' set to '640X480' and a text input for 'Maximum file size:' set to '100', with a note 'MB (16MB - 4097MB)'.

Paramètres d'enregistrement

Cette option permet de modifier l'emplacement par défaut des images ou vidéos capturées.

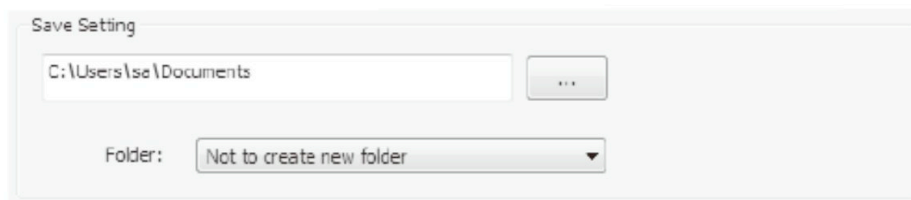

Save Setting

C:\Users\se\Documents

Folder: Not to create new folder

Paramètres de langue

Cette option permet de changer la langue du logiciel xploview.

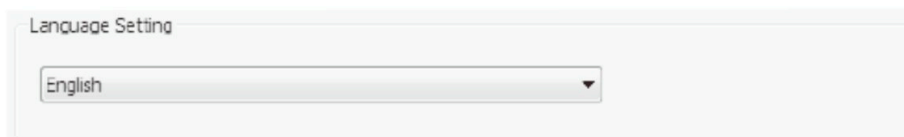

Language Setting

English

Paramètres avancés

En cliquant sur le bouton «More...» situé à droite du menu paramètres système, vous pouvez régler manuellement tous les paramètres de l'image. Notez que les paramètres disponibles peuvent être différents, cela dépend de votre système d'exploitation.

PC Windows

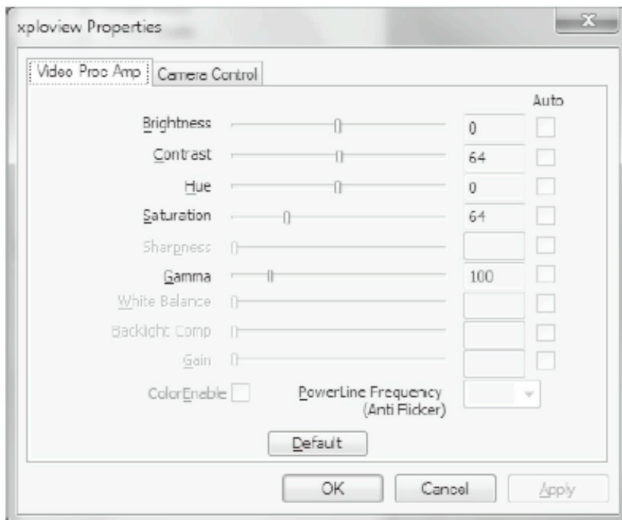

PC Mac OS

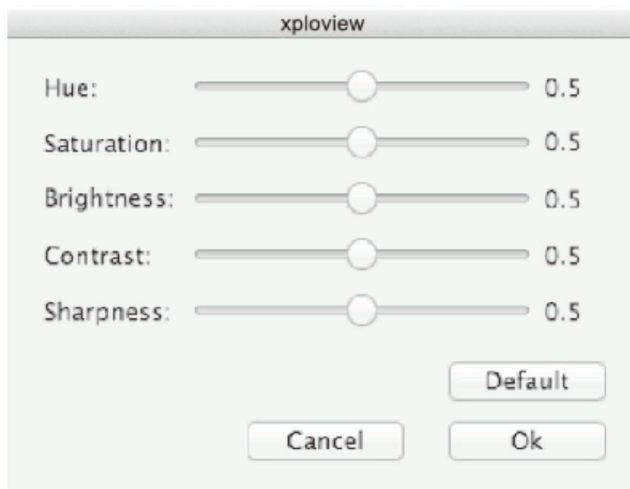

Fichiers enregistrés

Avec le logiciel xploview ouvert, vous pouvez localiser le dossier des fichiers enregistrés en cliquant sur le bouton «More...» situé à gauche de la fenêtre principale du logiciel.



Désinstallation du logiciel xploview

PC Windows

Sélectionnez «Désinstaller» dans le menu Démarrer (Démarrer > Tous les programmes > xploview > Désinstaller).

PC Mac OS

Faites glisser l'icône de l'application xploview du dossier «Applications» vers la «Corbeille».

Déclaration de conformité FCC (États-Unis seulement)

Cet appareil est conforme à l'article 15 de la réglementation FCC. Son utilisation est autorisée seulement dans les deux conditions suivantes : (1) Cet appareil ne peut causer d'interférences nuisibles et (2) il doit accepter toute interférence reçue, y compris les interférences pouvant entraîner un fonctionnement indésirable.

Tout changement/modification non expressément approuvé par la partie responsable de la conformité pourrait annuler l'autorisation accordée à l'utilisateur d'utiliser cet appareil.

Cet équipement a été testé et s'est avéré conforme aux limites définies dans l'article 15 du règlement FCC pour un équipement numérique de classe B. Ces limites sont conçues pour fournir une protection raisonnable contre les interférences nuisibles dans les installations résidentielles. Cet équipement génère, utilise et peut émettre de l'énergie radiofréquence, et, s'il n'est pas installé et utilisé conformément aux instructions, il peut produire des interférences affectant les communications radio. Cependant, rien ne garantit qu'aucun brouillage ne se produise dans une installation particulière. Si cet appareil produit des interférences nuisibles à la réception radio/télévision, pouvant facilement être constaté en l'éteignant et en le rallumant, nous vous incitons fortement à prendre l'une ou plusieurs des mesures suivantes :

- Réorienter ou déplacer l'antenne réceptrice.
- Éloigner davantage le récepteur de l'appareil.
- Brancher l'appareil à un circuit différent de celui sur lequel le récepteur est branché.
- Consultez votre revendeur ou un technicien radio/télévision qualifié.



Mentions légales

Ce document est publié sans aucune garantie. Bien que les informations fournies soient considérées comme étant exactes, elles peuvent comporter des erreurs ou des inexactitudes. En aucun cas, le fabricant ou ses distributeurs ne peuvent être tenus responsables des dommages directs ou indirects de toute nature, y compris mais non limité à la perte de profits ou pertes commerciales, découlant de l'utilisation des informations contenues dans ce document.

Tous droits réservés. Mac, Mac OS et OS X sont des marques d'Apple Inc., déposées aux États-Unis et dans d'autres pays. Windows est une marque déposée de Microsoft Corporation aux États-Unis et dans d'autres pays. Toutes les autres marques appartiennent à leurs propriétaires respectifs.

reflecta[®]

DigiMicroscope Vario

Manual de Instrucciones   
para xploview v 3.2



Android-App



DE

EN

FR

ES

IT

NL

ES

CONTENIDO

ANTES DEL USO	4
Información importante.....	4
Cuidados y mantenimiento	4
Advertencia	4
Descripción del producto	5
Requisitos del ordenador.....	5
DESCRIPCIÓN GENERAL DEL PRODUCTO	6
Contenido del paquete	6
Características generales del producto	7
Especificaciones del producto	8
PUESTA EN MARCHA	9
Instalación del software	9
Conectar el dispositivo	10
Ejecutar el software xploview	10
Instalar un portaobjetos	11
CONCEPTOS BÁSICOS	12
Seleccionar una fuente de luz	12
Seleccionar una potencia de ampliación	13
Enfoque.....	14
Tomar una instantánea.....	15
UTILIZAR EL SOFTWARE XPLOVIEW	16
Menú de botones.....	16
Visualización a pantalla completa.....	17
Rotar/girar la imagen	18
Menú de ajustes del sistema	19
Configuración del dispositivo	20
Configurar la captura temporizada	20
Configurar película.....	20
Ajustes de guardado	21
Ajuste del Idioma	21
Ajustes avanzados.....	22
Archivos guardados.....	23
Desinstalar el software xploview.....	23

ANTES DEL USO

Información importante

Por favor, lea detenidamente este manual de instrucciones antes de utilizar este producto y conserve estas instrucciones para futuras consultas.

Podrían realizarse mejoras y cambios sin previo aviso en este texto, debido a errores tipográficos o a mejoras en el software y/o en los equipos.

Cuidados y mantenimiento

- Evite las vibraciones, golpes y presiones causados por ejemplo por dejar caer el microscopio.
- Mantenga seco el dispositivo y protéjalo del agua o vapor.
- No deje su dispositivo en un lugar con temperaturas extremadamente altas o bajas.
- No toque el dispositivo con las manos húmedas, ya que podría ocasionarle daños al dispositivo o provocar una descarga eléctrica al usuario.
- No utilice ni guarde el dispositivo en áreas polvorientas y sucias, ya que las partes móviles podrían dañarse.
- No utilice productos químicos abrasivos, disolventes de limpieza ni detergentes fuertes para limpiar el dispositivo. Frótelo con un paño suave ligeramente humedecido con una solución de agua y jabón suave.

Advertencia

- No coloque el microscopio digital iluminado sobre sus ojos, ya que podría sufrir lesiones oculares permanentes.
- No intente abrir ni desmontar el microscopio digital.

Descripción del producto

- Este producto es distinto de los microscopios ópticos tradicionales, ya que, en lugar de mirar a través de un ocular, la imagen ampliada o el vídeo en directo se visualiza en el monitor de un ordenador mediante una conexión USB.
- Este producto dispone de una torreta de objetivos integrada con seis lentes diferentes. Cuando la imagen se observa en un monitor de 17", este producto puede ampliar las muestras a 100x, 200x, 300x, 400x, 500x y 600x. La ampliación depende del tamaño del monitor empleado: cuanto mayor sea el monitor, mayor será la ampliación.
- Las instantáneas de las muestras pueden capturarse mediante el botón de captura situado en la parte superior del dispositivo. Los vídeos en directo y las instantáneas pueden almacenarse en el ordenador utilizando el software incluido.

Requisitos del ordenador

PC con S.O. Windows

Sistemas operativos compatibles

Windows 10 (32 bit o 64 bit)
Windows 8 (32 bit o 64 bit)
Windows 7 (32 bit o 64 bit)
Windows Vista (32 bit o 64 bit)
Windows XP SP2, SP3

USB

USB 2.0

PC con S.O. Mac

Sistemas operativos compatibles

Mac OS X 10.5.6 - Mac OS X 10.11.x

USB

USB 2.0

DESCRIPCIÓN GENERAL DEL PRODUCTO

Contenido del paquete

Microscopio digital con cable USB

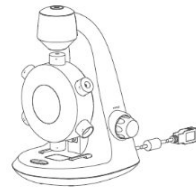

Portaobjetos en blanco para muestras x3
Portaobjetos preparados con muestra de algodón



Pinzas

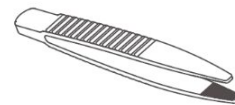

Cubreobjetos en blanco para muestras x6

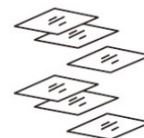

CD de
Instalación



Manual de
usuario



Cuentagotas



Características generales del producto

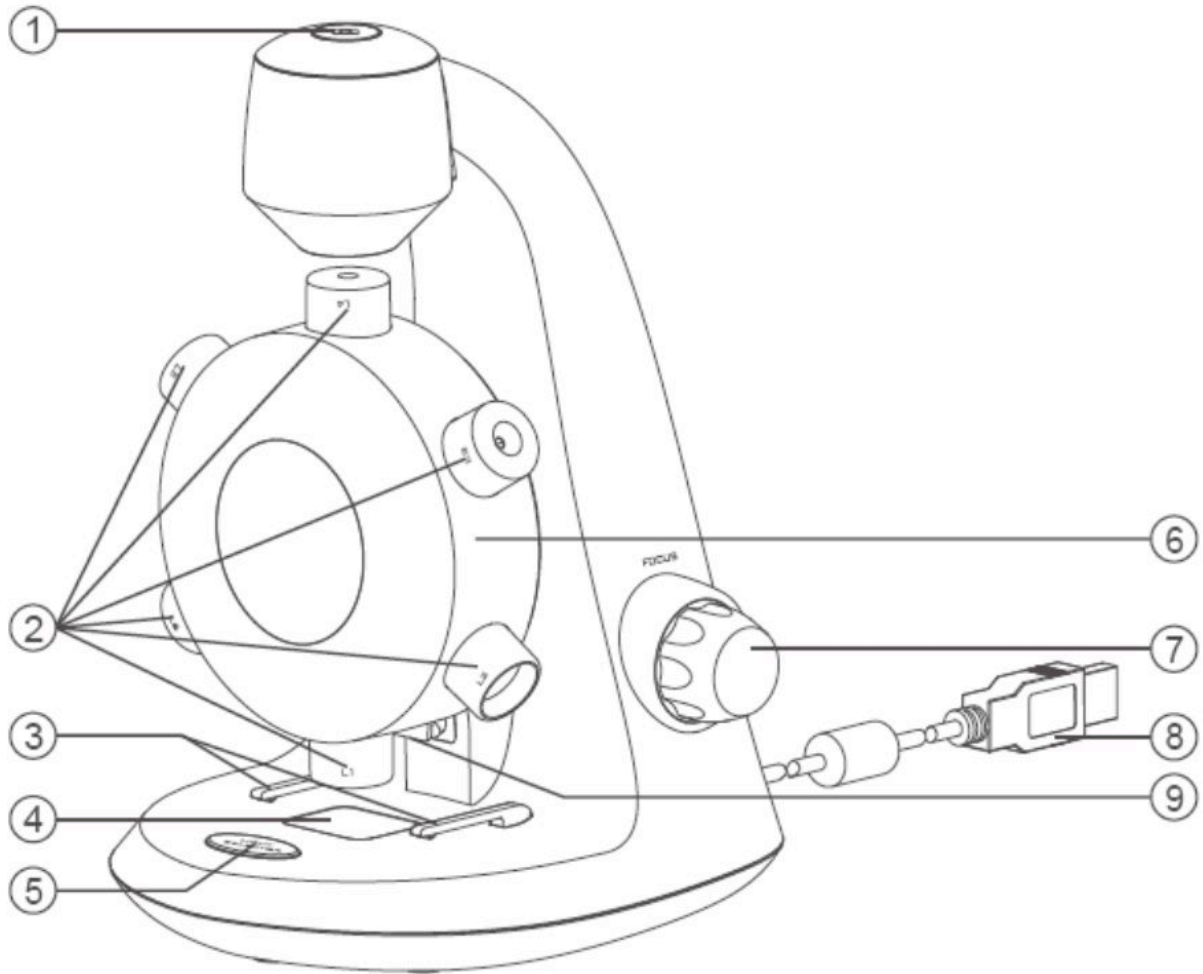

1. Botón de captura
2. Objetivos
3. Pinza para el portaobjetos
4. Cartucho portaobjetos
5. Interruptor de selección de iluminación
6. Torreta de objetivos
7. Control de enfoque
8. Cable USB
9. LED

Especificaciones del producto

Tipo de conexión	USB 2.0
Área de observación efectiva	L1 = 3,6 x 2,7 mm L2 = 1,8 x 1,4 mm L3 = 1,2 x 0,9 mm L4 = 0,9 x 0,7 mm L5 = 0,7 x 0,5 mm L6 = 0,6 x 0,45 mm
Potencia de ampliación (visionado en un monitor de 17")	L1 = 100x L2 = 200x L3 = 300x L4 = 400x L5 = 500x L6 = 600x
Iluminación	LED
Fuente de alimentación	5 V \equiv 250 mA (vía USB)
Sensor	CMOS
Resolución máxima de captura	1.600 x 1.200 píxeles (UXGA)
Resolución máxima de captura de vídeo	640 x 480 píxeles (VGA)
Tamaño	130 mm x 154 mm x 208 mm
Peso	369 gramos



PUESTA EN MARCHA

Instalación del software

PC con S.O. Windows

- Inserte el CD de aplicación incluido en la unidad CD-ROM del ordenador.
- Haga doble clic en el icono "xploview v3.2.xx.exe" <  > que se encuentra en el CD.
- Siga el asistente de configuración del xploview para instalar el software del microscopio digital.

PC con S.O. Mac

- Inserte el CD de aplicación incluido en la unidad CD-ROM del ordenador.
- Haga doble clic en el icono "xploview v3.2.xx.dmg" <  > que se encuentra en el CD.
- Arrastre el icono xploview <  > a la carpeta de aplicaciones.

Conectar el dispositivo

Conecte el dispositivo al ordenador utilizando el cable USB incluido.

Ejecutar el software xploview

PC con S.O. Windows

El software xploview puede ejecutarse haciendo doble clic en el icono xploview del escritorio o en el menú de inicio.

PC con S.O. Mac

El software xploview puede ejecutarse haciendo doble clic en el icono xploview del menú de aplicaciones.

Nota

Cuando el dispositivo se conecte por primera vez al ordenador, se instalará un controlador automáticamente para Windows o Mac OS. Este proceso puede durar unos pocos minutos.

Cada vez que ejecute el software xploview, el dispositivo se debería encender automáticamente. Si no es así, puede seleccionar el dispositivo en la sección de configuración del dispositivo del menú de ajustes del sistema.

Instalar un portaobjetos

Coloque un portaobjetos preparado con una muestra en el cartucho portaobjetos y deslícelo dentro de las pinzas para que éstas sujeten la muestra de forma segura.

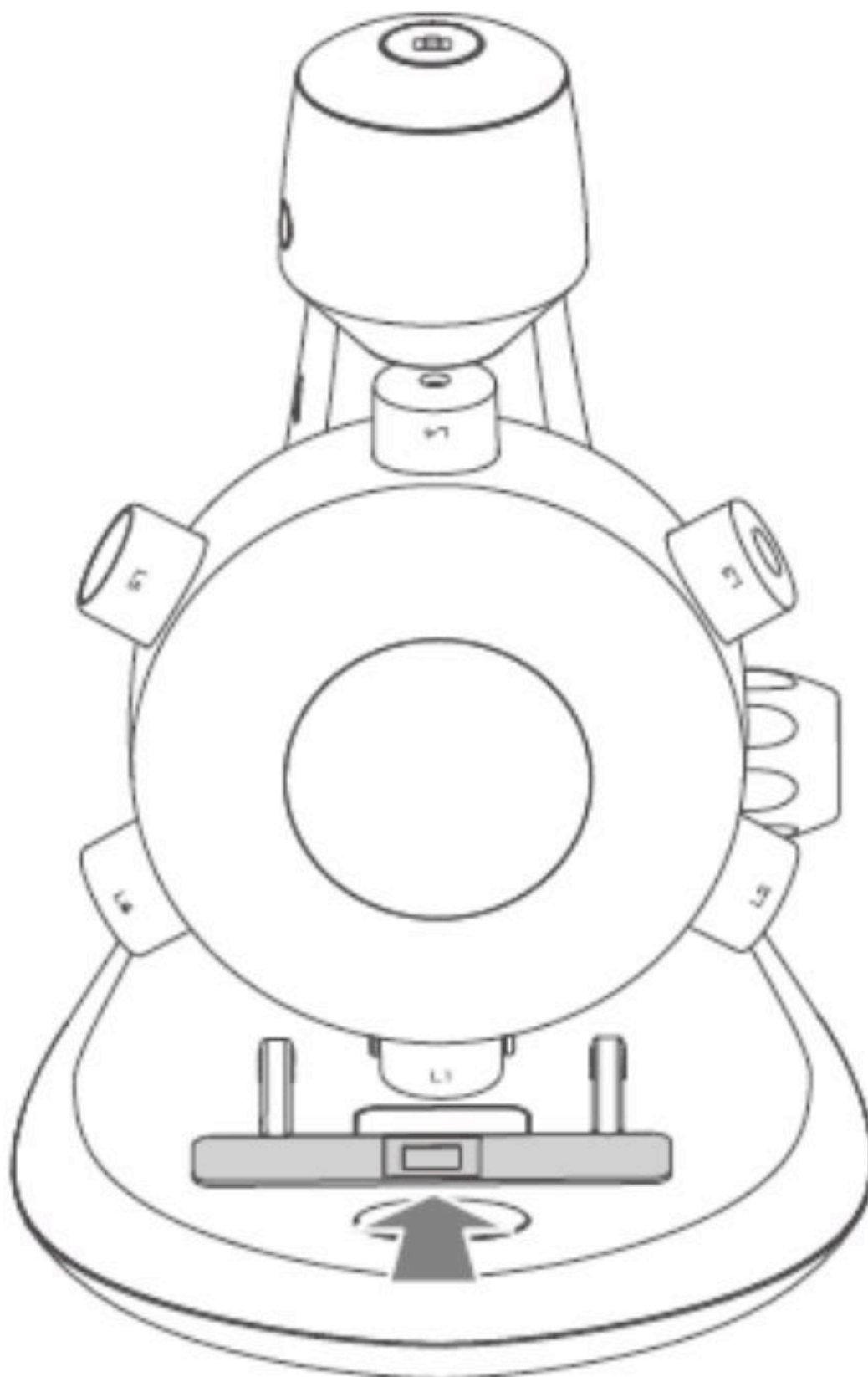

CONCEPTOS BÁSICOS

Seleccionar una fuente de luz

Este microscopio digital contiene dos fuentes de luz, una situada sobre el cartucho y otra debajo, para aportar iluminación incidente y transmitida respectivamente.

Cuando el dispositivo se conecta a un ordenador, al ejecutar el software incluido, una de las luces se encenderá.

Pulse una vez el interruptor de selección de iluminación para cambiar al sistema de iluminación que desee. Cuando abandone el software, la luz se apagará automáticamente.

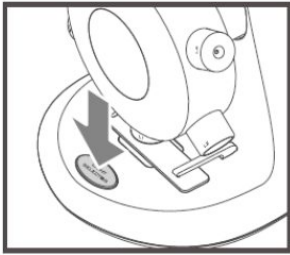

Púselo una vez para cambiar el sistema de iluminación

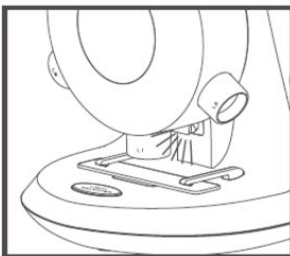

Iluminación incidente

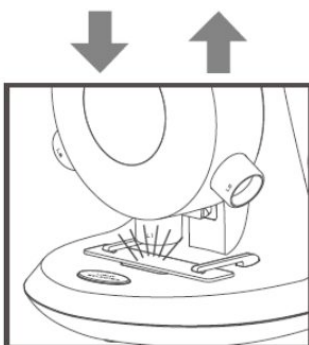

Iluminación transmitida

Seleccionar una potencia de ampliación

La torreta de objetivos puede girar en ambos sentidos: en sentido de las agujas del reloj y al contrario.

Tomando como ejemplo el objetivo de menor potencia, L1, gire la torreta de objetivos hasta que la lente L1 quede directamente encima de la muestra. Cuando el objetivo esté correctamente alineado, sentirá un "clic".

Gire la torreta de objetivos para seleccionar la ampliación deseada.

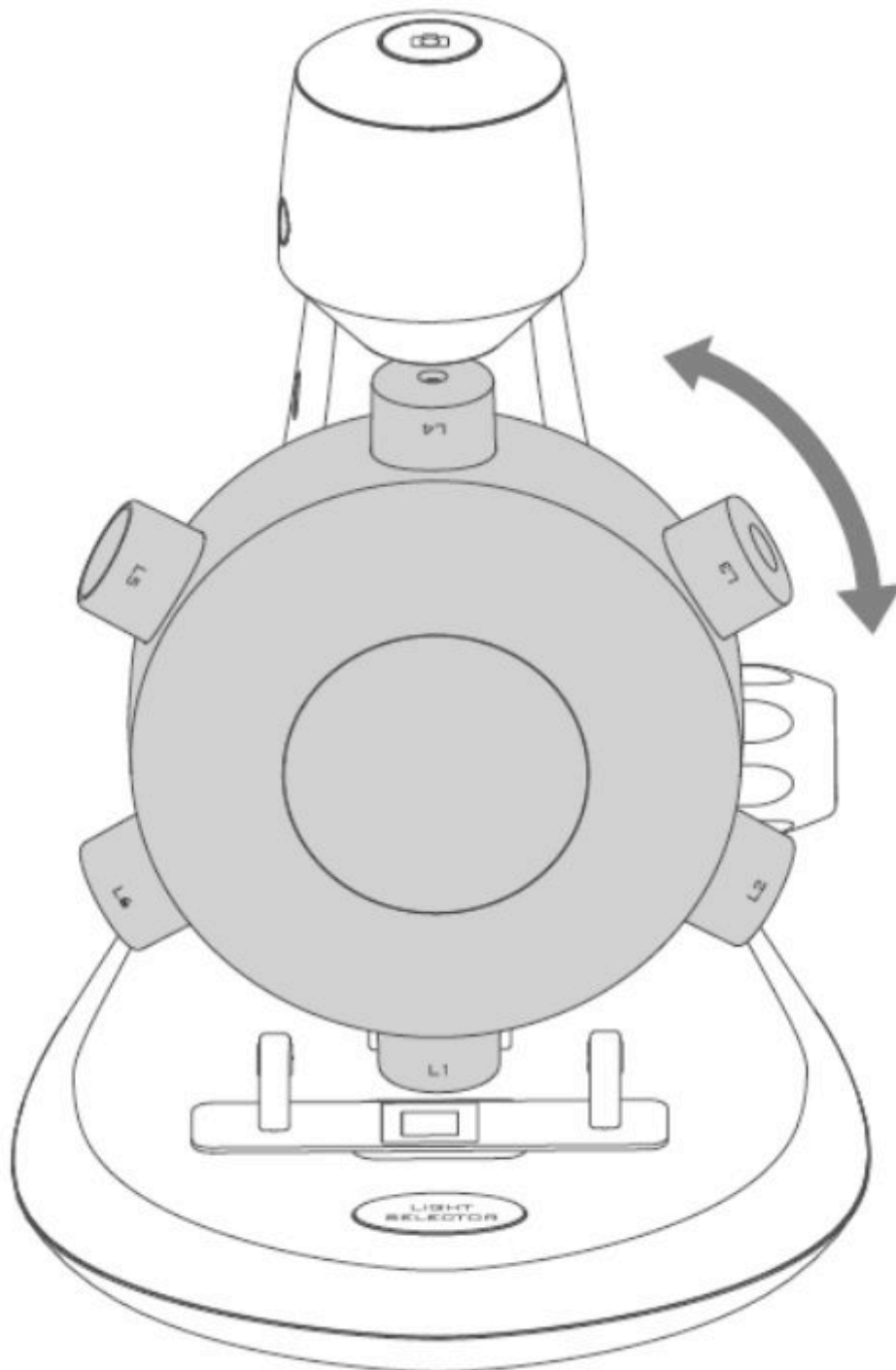

Enfoque

Gire el control de enfoque en sentido de las agujas del reloj o al contrario, hasta que la imagen sea nítida.

Nota: Por favor, asegúrese de que el objetivo esté libre de obstáculos y de que no golpee el portaobjetos mientras el objetivo desciende durante el enfoque.

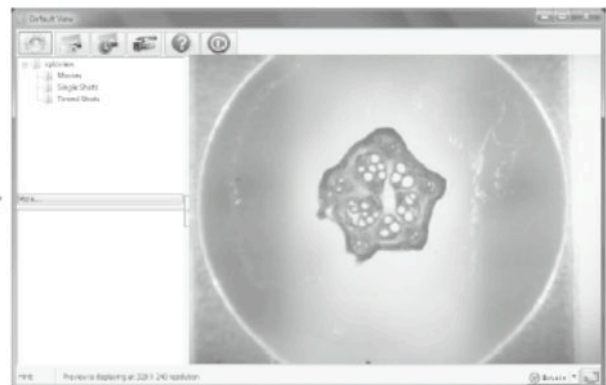
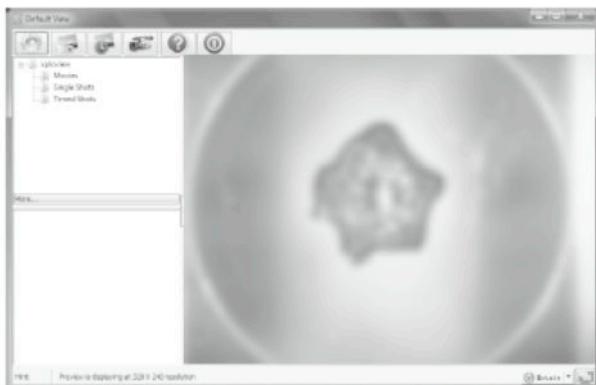
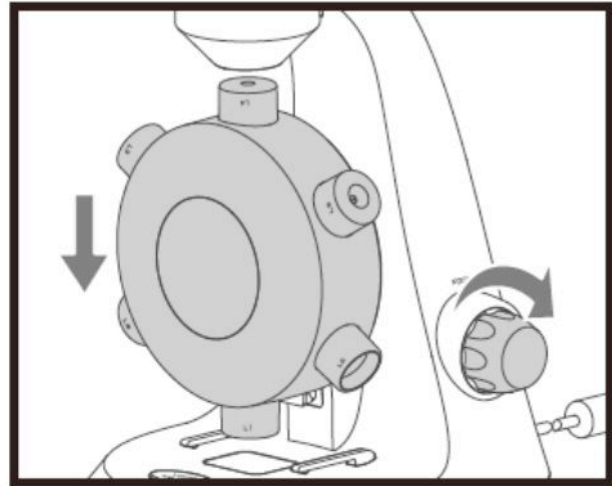
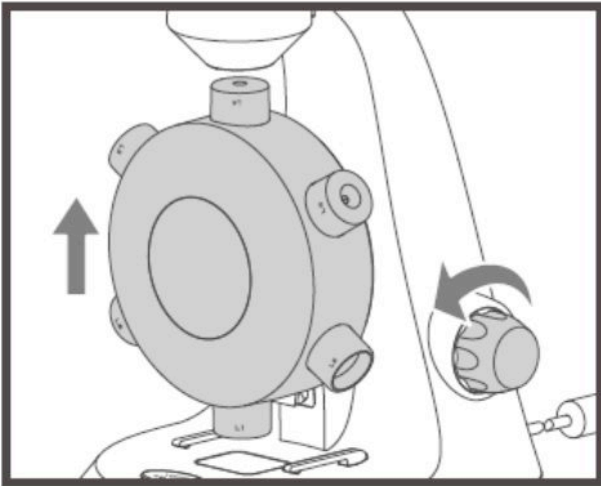

Tomar una instantánea

Pulse el botón de captura para tomar una instantánea.

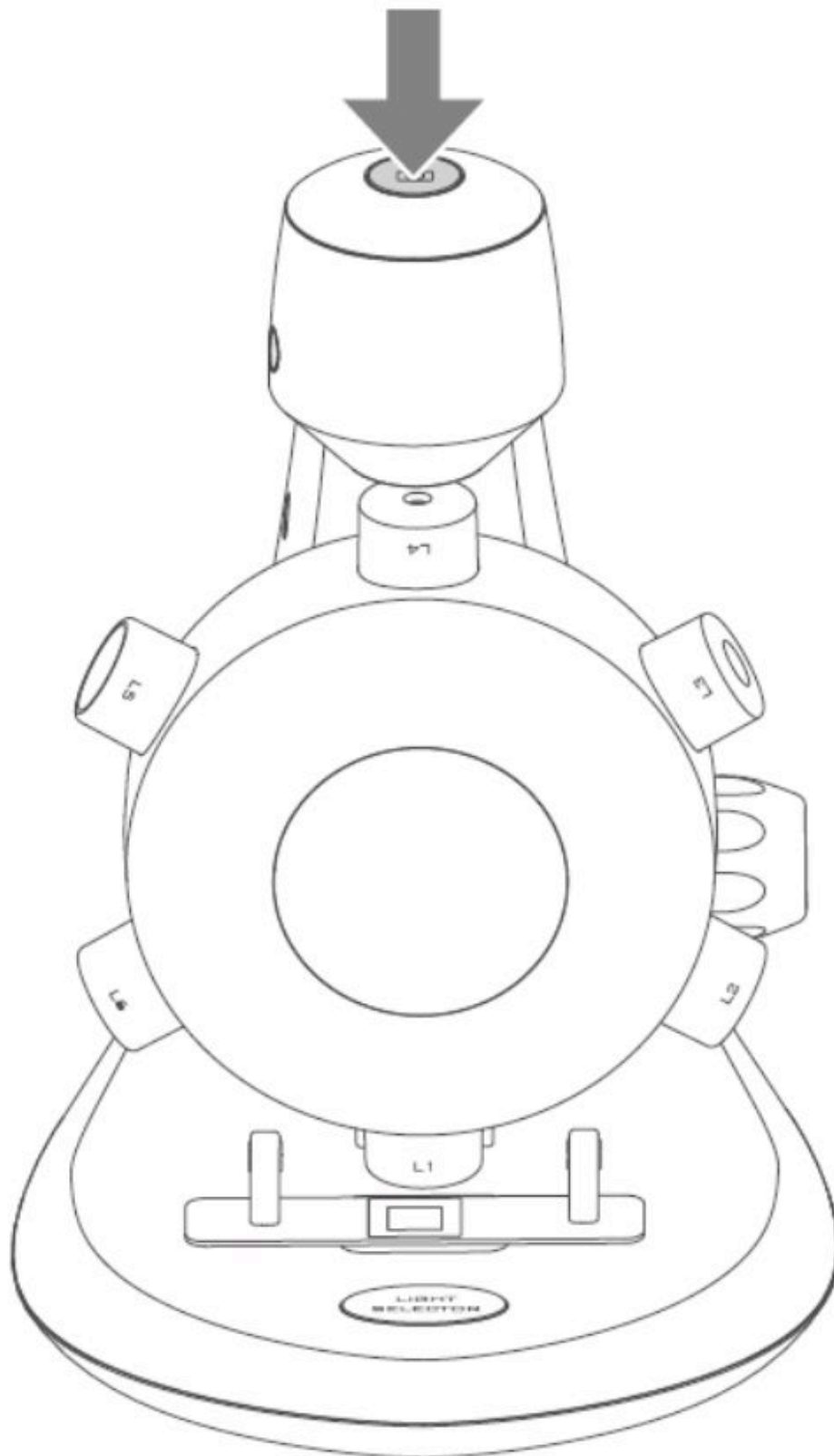

UTILIZAR EL SOFTWARE XPLOVIEW

Menú de botones

Los iconos en el menú de botones:



Abrir el **menú de ajustes del sistema** (vea el menú de ajustes del sistema en la página 19).



Capturar la imagen en pantalla.



Iniciar y detener la **captura temporizada**. Las imágenes de capturarán a intervalos regulares (vea el menú de ajustes del sistema en la página 20 para ajustar la frecuencia y la duración).



Iniciar y detener la **grabación de vídeo**.



Información sobre el software. Esta información puede resultar útil al actualizar el software de aplicación.



Detener el software de aplicación.

Visualización a pantalla completa

Para activar el modo de pantalla completa, haga clic en el botón de pantalla completa , situado en la esquina inferior derecha de la ventana del software de aplicación xploview.

Para salir del modo de pantalla completa, haga doble clic en la pantalla, o pulse el botón "Esc" del teclado.

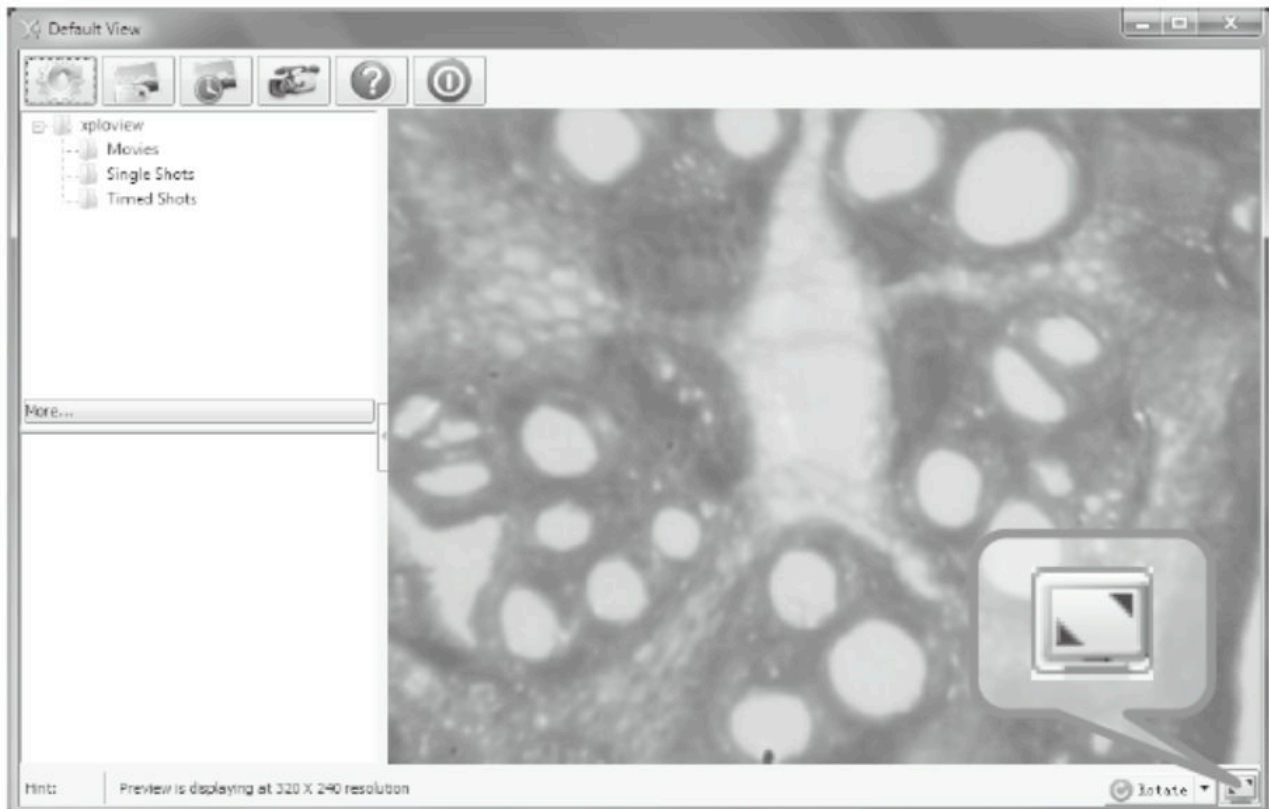

Rotar/girar la imagen

Haga clic en el botón  Rotate > para rotar o girar la imagen.

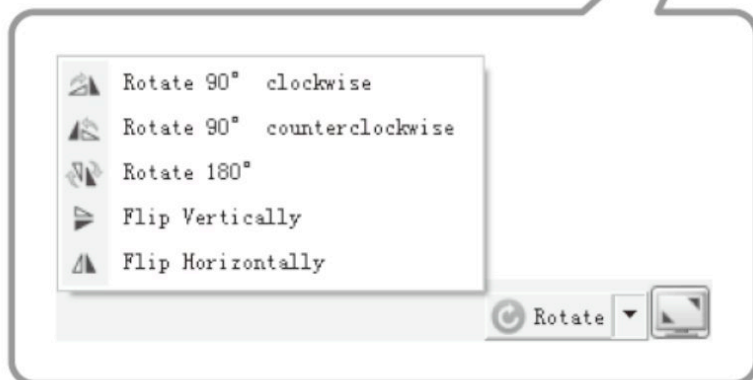
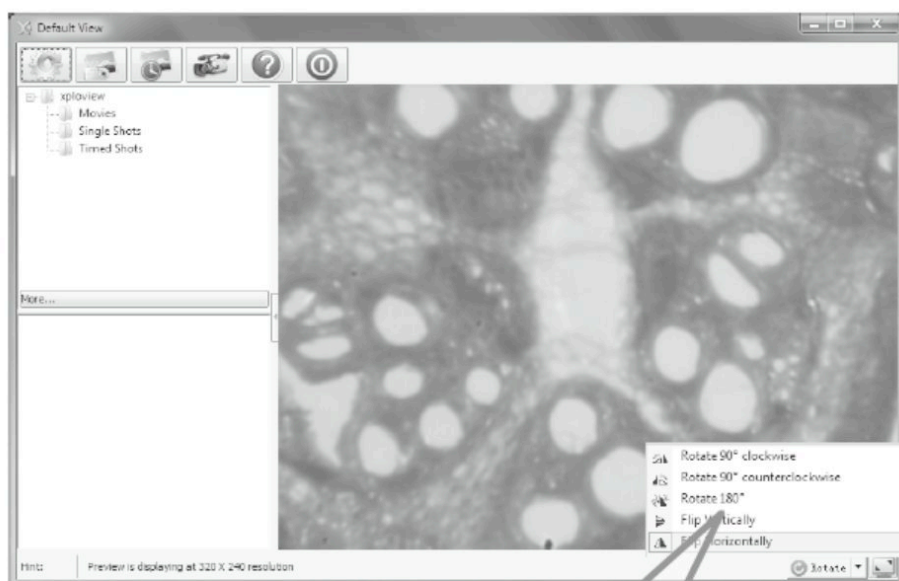

Menú de ajustes del sistema

La primera vez que ejecute el software xploview, se cargarán los ajustes por defecto; podrá cambiar estos ajustes manualmente en el menú de ajustes del sistema.

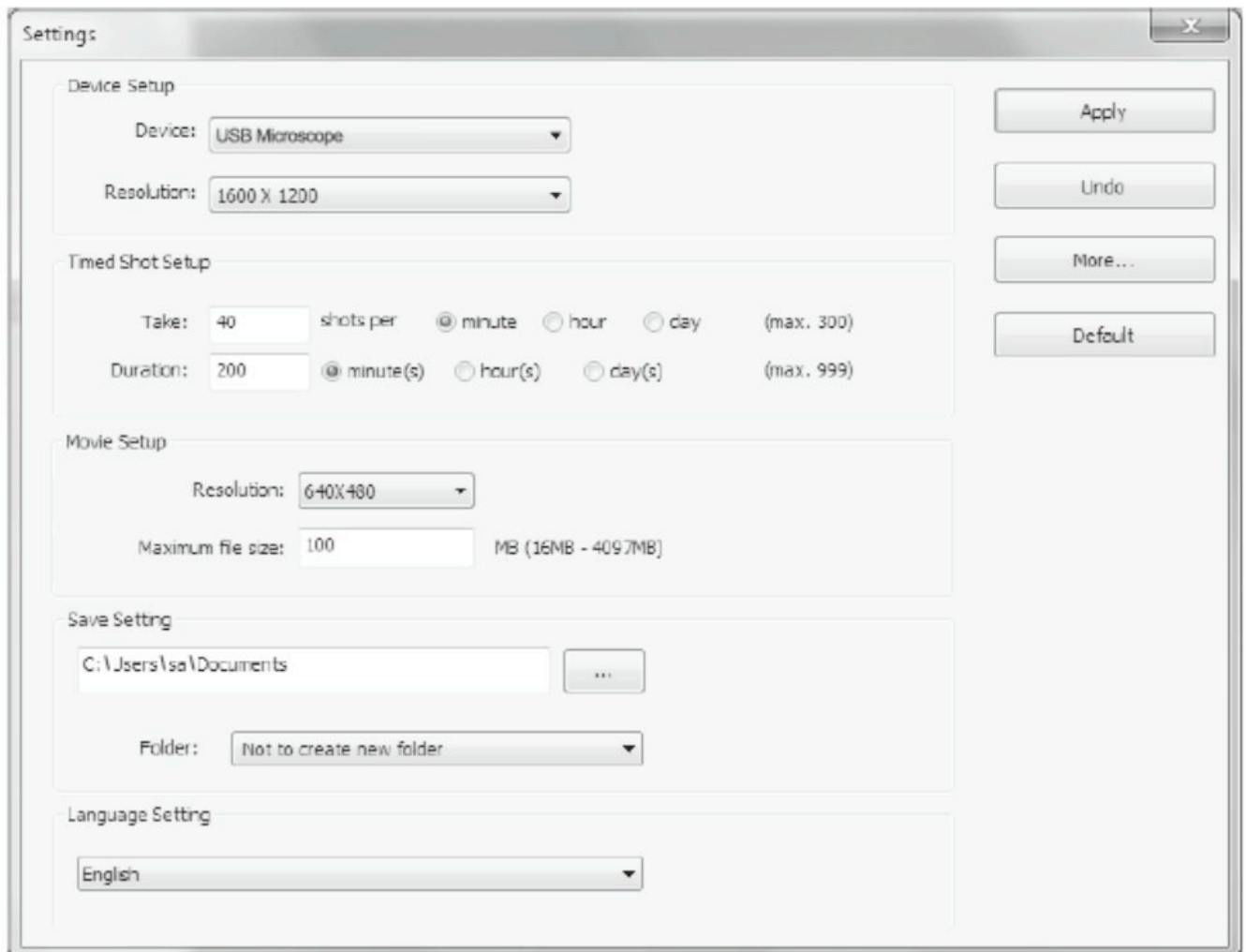

Configuración del dispositivo

Si la imagen capturada por el microscopio digital no se visualiza por defecto, puede cambiar esta opción seleccionándola en el menú desplegable "Device".

La resolución de las imágenes que capture puede modificarse en el menú desplegable "Resolution".

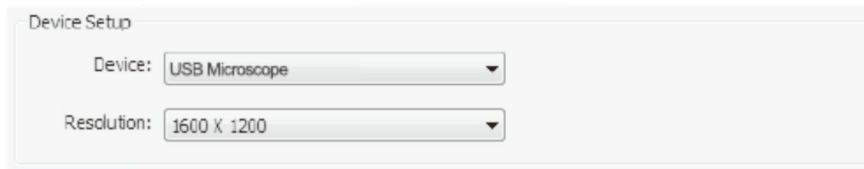

The screenshot shows a 'Device Setup' panel with two dropdown menus. The first menu is labeled 'Device:' and is set to 'USB Microscope'. The second menu is labeled 'Resolution:' and is set to '1600 X 1200'.

Configurar la captura temporizada

La frecuencia y la duración de la captura automática de imágenes puede ajustarse en esta opción.

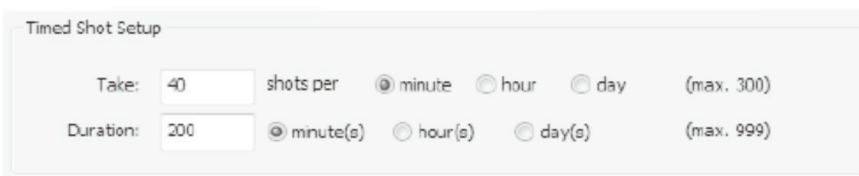

The screenshot shows a 'Timed Shot Setup' panel. It has two rows of controls. The first row is labeled 'Take:' and has a text input field with '40', followed by 'shots per' and three radio buttons: 'minute' (selected), 'hour', and 'day'. To the right is '(max. 300)'. The second row is labeled 'Duration:' and has a text input field with '200', followed by three radio buttons: 'minute(s)' (selected), 'hour(s)', and 'day(s)'. To the right is '(max. 999)'.

Configurar película

La resolución de los vídeos que grabe puede modificarse en el menú "Resolution". También puede establecer un tamaño máximo de archivo para cada vídeo.

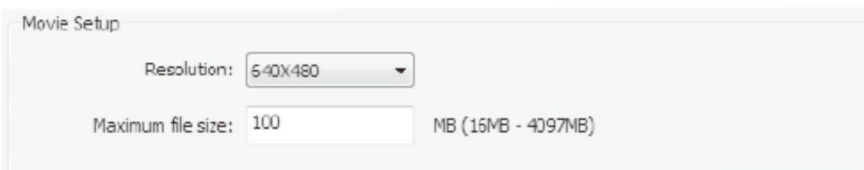

The screenshot shows a 'Movie Setup' panel. It has two rows of controls. The first row is labeled 'Resolution:' and has a dropdown menu set to '540X480'. The second row is labeled 'Maximum file size:' and has a text input field with '100' and 'MB (15MB - 4097MB)' to its right.

Ajustes de guardado

La ubicación por defecto de las imágenes o vídeos capturados puede cambiarse en esta opción.

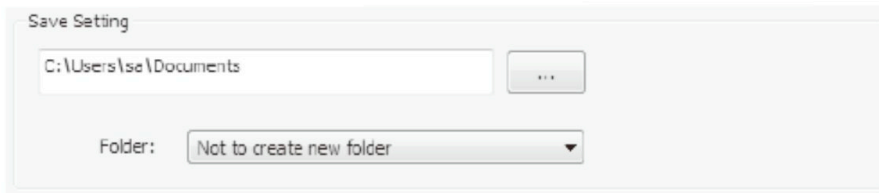

Save Setting

C:\Users\se\Documents

Folder: Not to create new folder

Ajuste del Idioma

El idioma del software xploview puede cambiarse en esta opción.

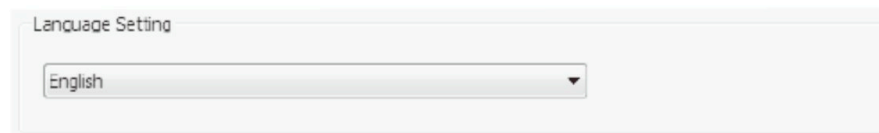

Language Setting

English

Ajustes avanzados

Haciendo clic en el botón "More..." de la derecha del menú de ajustes del sistema, podrá configurar todos los ajustes de imagen. Tenga en cuenta que los ajustes disponibles pueden variar dependiendo de su sistema operativo.

PC con S.O. Windows

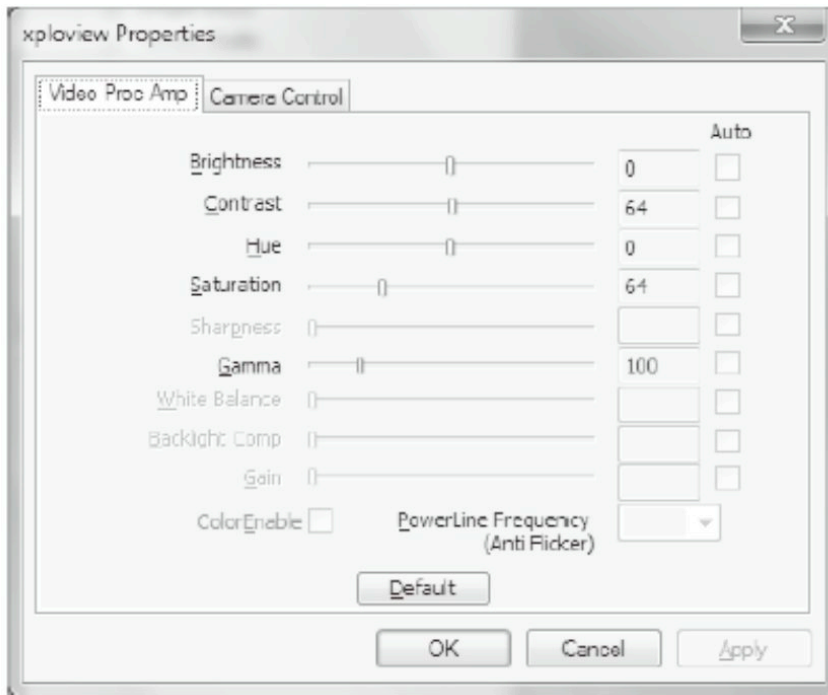

PC con S.O. Mac

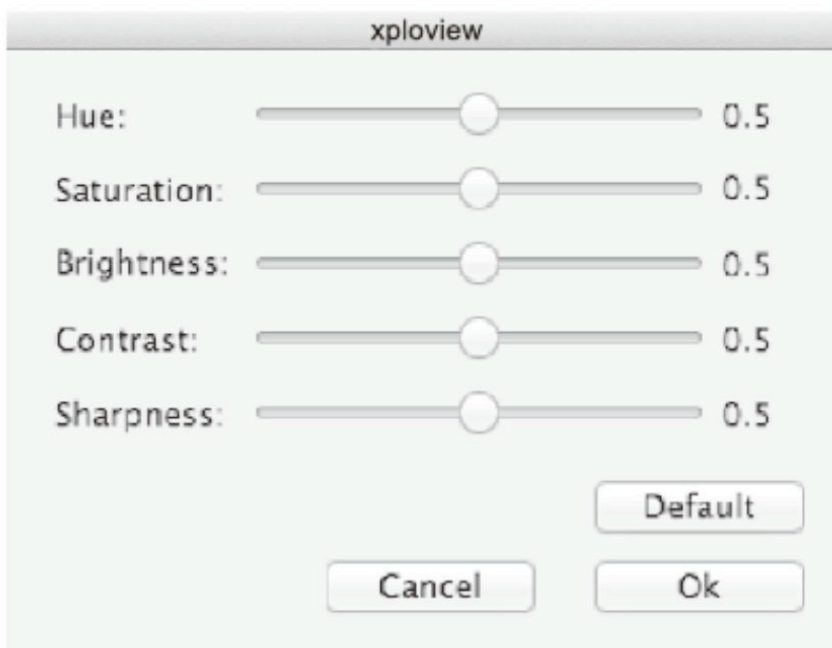

Archivos guardados

Con el software xploview en ejecución, puede localizar la carpeta de archivos guardados haciendo clic en el botón "More..." situado a la izquierda de la ventana principal del software.

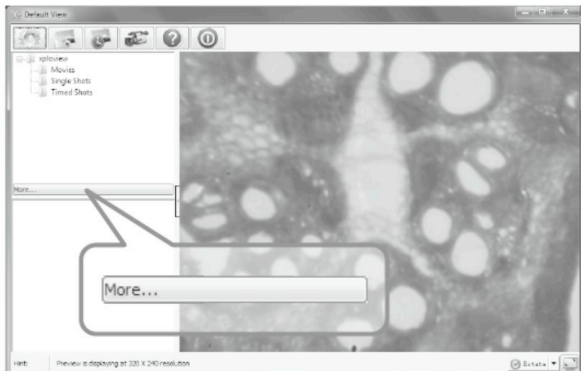

Desinstalar el software xploview

PC con S.O. Windows

En el menú de inicio, seleccione "Desinstalar" (Inicio > Todos los programas > xploview > Desinstalar).

PC con S.O. Mac

Arrastre el icono de la aplicación xploview desde "Aplicaciones" hasta la "Papelera".

Declaración de conformidad de la FCC (Únicamente EE.UU.)

Este dispositivo cumple con la Parte 15 de la Normativa FCC. La utilización está sujeta a las siguientes dos condiciones: (1) Este dispositivo no debe causar interferencias perjudiciales, y (2) este dispositivo debe aceptar cualquier interferencia recibida, incluyendo interferencias que pudieran causar una operación no deseada.

Todos los cambios o modificaciones no aprobados expresamente por la parte responsable del cumplimiento podrán anular la autoridad del usuario para utilizar el dispositivo.

Este equipo ha sido probado y se ha demostrado que cumple con los límites para los dispositivos digitales de Clase B, según la Parte 15 de la Normativa FCC. Estos límites están diseñados para proporcionar una protección razonable frente a interferencias perjudiciales en una instalación residencial. Este equipo genera, utiliza y puede irradiar energía de radio frecuencia y, si no se instala y utiliza de acuerdo a las instrucciones, puede causar interferencias perjudiciales en las comunicaciones por radio. Sin embargo, no se garantiza que esta interferencia no se dé en una instalación en particular. Si este equipo causa interferencias perjudiciales en la recepción de radio o televisión, lo que puede determinarse apagando y encendiendo el equipo, se anima al usuario a corregir la interferencia, mediante una o más de las siguientes medidas:

- Reorientar o recolocar la antena receptora.
- Aumentar la separación entre el equipo y el receptor.
- Conectar el dispositivo a una toma de corriente de un circuito distinto al que esté conectado el receptor.
- Consultar al distribuidor o a un técnico experto en radio/TV.

Información legal

Este documento se publica sin ninguna garantía. Pese a que creemos que la información proporcionada es precisa, puede incluir errores o inexactitudes. En ningún caso, el fabricante o sus distribuidores serán responsables de los daños incidentales o consecuentes de ninguna naturaleza, incluyendo, pero no limitado a, pérdida de beneficios o pérdidas comerciales que surjan del uso de la información incluida en este documento.

Reservados todos los derechos. Mac, Mac OS y OS X son marcas comerciales de Apple Inc., registradas en los EE.UU. y otros países. Windows es una marca comercial registrada de Microsoft Corporation en los Estados Unidos y en otros países. Todas las demás marcas y marcas comerciales son propiedad de sus respectivos propietarios.

reflecta[®]

DigiMicroscope Vario

Manuale di istruzioni
per xpoview v 3.2

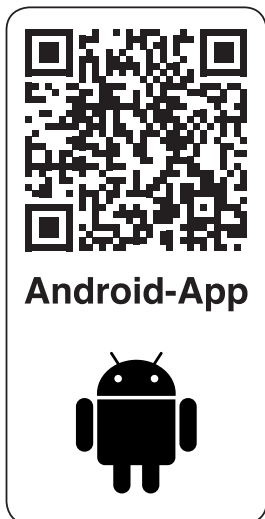
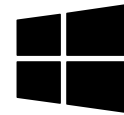

DE

EN

FR

ES

IT

NL

IT

CONTENUTO

PRIMA DELL'USO	4
Informazioni importanti	4
Cura e manutenzione	4
Avvertenze	4
Descrizione del prodotto	5
Requisiti del computer	5
PANORAMICA	6
Contenuto della confezione	6
Panoramica del prodotto	7
Specifiche del prodotto	8
INTRODUZIONE	9
Installazione del software	9
Collegamento dell'unità	10
Avvio del programma xploview	10
Installazione di un vetrino	11
OPERAZIONI PRINCIPALI	12
Selezione della sorgente luminosa	12
Selezione della potenza di ingrandimento	13
Messa a fuoco	14
Istantanee	15
USO DEL PROGRAMMA XPLOVIEW	16
Menu pulsanti	16
Vista a schermo intero	17
Rotazione/Capovolgimento dell'immagine	18
Menu di impostazioni del sistema	19
Configurazione dell'unità	20
Impostazione scatto temporizzato	20
Impostazione video	20
Impostazioni di archiviazione	21
Impostazione della lingua	21
Impostazioni avanzate	22
Immagini salvate	23
Disinstallazione del programma xploview	23

PRIMA DELL'USO

Informazioni importanti

Prima di utilizzare il dispositivo, leggere attentamente il presente manuale di istruzioni e conservarlo per eventuali consultazioni future.

Modifiche e miglioramenti del testo dovuti ad errori tipografici o miglioramenti al software e/o all'apparecchiatura possono essere apportati in qualsiasi momento senza preavviso.

Cura e manutenzione

- Non sottoporre il microscopio a vibrazioni, urti, pressioni e cadute.
- Tenere il dispositivo asciutto e proteggerlo da acqua e vapore.
- Non lasciare il dispositivo in ambienti con temperature eccessivamente alte o basse.
- Non toccare il dispositivo con le mani bagnate per evitare di danneggiarlo e prevenire il rischio di scosse elettriche.
- Non utilizzare il dispositivo in ambienti polverosi o sporchi in quanto ciò potrebbe danneggiarne le parti mobili.
- Non utilizzare solventi, sostanze chimiche o detergenti aggressivi per pulire il dispositivo. Pulirlo con un panno morbido e leggermente inumidito con una soluzione delicata di acqua e sapone.

Avvertenze

- Non dirigere la luce del microscopio digitale sugli occhi, in quanto ciò può causare danni permanenti alla vista.
- Non cercare di aprire o smontare il microscopio digitale.

Descrizione del prodotto

- Questo prodotto differisce da altri microscopi ottici tradizionali: invece di dover guardare attraverso un oculare, l'immagine o il filmato ingranditi saranno visualizzati sullo schermo di un computer tramite connessione USB.
- Questo prodotto è dotato di portaobiettivi a revolver integrato a sei posti. Durante la visualizzazione su uno schermo da 17", l'unità può ingrandire preparati 100x, 200x, 300x, 400x, 500x e 600x. Il potere di ingrandimento dipende dalle dimensioni dello schermo utilizzato: quanto più grande è lo schermo, tanto più elevato sarà l'ingrandimento.
- Istantanee dei preparati possono essere acquisite utilizzando l'apposito pulsante situato sul lato superiore dell'unità. Video dal vivo e istantanee possono essere acquisiti e archiviati sul computer utilizzando il programma fornito in dotazione.

Requisiti del computer

Computer basato su Windows

Sistemi operativi compatibili

Windows 10 (32 bit o 64 bit)

Windows 8 (32 bit o 64 bit)

Windows 7 (32 bit o 64 bit)

Windows Vista (32 bit o 64 bit)

Windows XP SP2, SP3

USB

USB 2.0

Computer basato su Mac OS

Sistemi operativi compatibili

Mac OS X 10.5.6 - Mac OS X 10.11.x

USB

USB 2.0

PANORAMICA

Contenuto della confezione

Microscopio digitale con cavo
USB

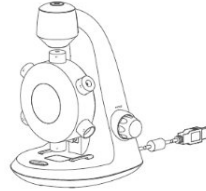

Vetrini porta-preparato vuoti x3
Vetrini preparati con cotone per
preparato



Pinzette

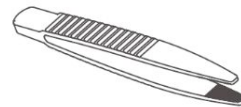

Coperchio vetrini porta-preparato
x6

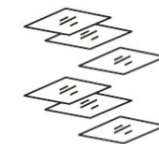

CD di
installazione



Manuale utente



Contagocce



Panoramica del prodotto

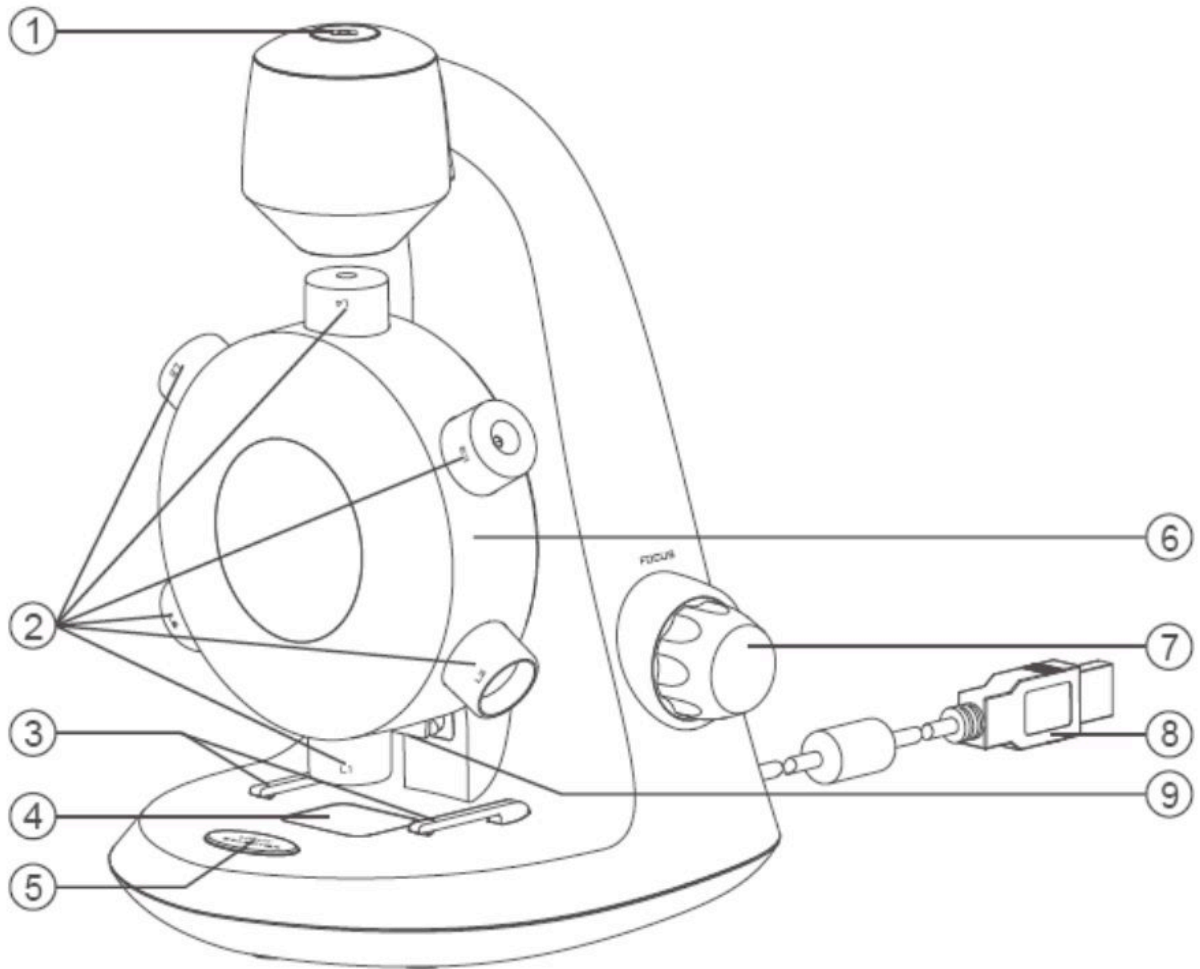

1. Pulsante Istantanea
2. Obiettivi
3. Fermaglio vetrino porta-preparato
4. Piano porta-preparato
5. Selettore della luce
6. Portaobiettivi a revolver
7. Manopola di messa a fuoco
8. Cavo USB
9. LED

Specifiche del prodotto

Tipo di connessione	USB 2.0
Area di osservazione effettiva	L1 = 3,6 x 2,7 mm L2 = 1,8 x 1,4 mm L3 = 1,2 x 0,9 mm L4 = 0,9 x 0,7 mm L5 = 0,7 x 0,5 mm L6 = 0,6 x 0,45 mm
Potere di ingrandimento (con uno schermo da 17")	L1 = 100x L2 = 200x L3 = 300x L4 = 400x L5 = 500x L6 = 600x
Illuminazione	LED
Alimentazione	5 V $\overline{\text{---}}$ 250 mA (via USB)
Sensore	CMOS
Risoluzione massima scatto	1600 x 1200 pixel (UXGA)
Risoluzione massima acquisizione video	640 x 480 pixel (VGA)
Dimensione	130 mm x 154 mm x 208 mm
Peso	369 grammi



INTRODUZIONE

Installazione del software

Computer basato su Windows

- Inserire il CD di installazione in dotazione nell'unità CD-ROM del computer.
- Fare doppio clic sull'icona "xploview v3.2.xx.exe" <  > nel CD contenente i driver.
- Seguire la procedura di configurazione guidata per installare il software del microscopio digitale.

Computer basato su Mac OS

- Inserire il CD di installazione in dotazione nell'unità CD-ROM del computer.
- Fare doppio clic sull'icona "xploview v3.2.xx.dmg" icon <  > nel CD contenente i driver.
- Trascinare l'icona xploview <  > nella cartella delle applicazioni.

Collegamento dell'unità

Collegare l'unità a un computer utilizzando il cavo USB in dotazione.

Avvio del programma xploview

Computer basato su Windows

Il programma xploview può essere avviato facendo doppio clic sull'icona dalla schermata del desktop oppure dal menu di avvio.

Computer basato su Mac OS

Il programma xploview può essere avviato facendo doppio clic sull'icona nel menu delle applicazioni.

Nota

Quando l'unità è connessa al computer per la prima volta, un driver sarà installato automaticamente dal sistema operativo Windows o Mac. Questo processo può richiedere alcuni minuti.

L'unità viene avviata automaticamente ogni volta che il programma xploview viene lanciato. In alternativa, selezionare l'unità nella sezione di installazione dei dispositivi nel menu delle impostazioni del sistema.

Installazione di un vetrino

Collocare un vetrino opportunamente preparato sul piano porta-preparato e farlo scorrere tra i fermagli fissandolo in posizione.

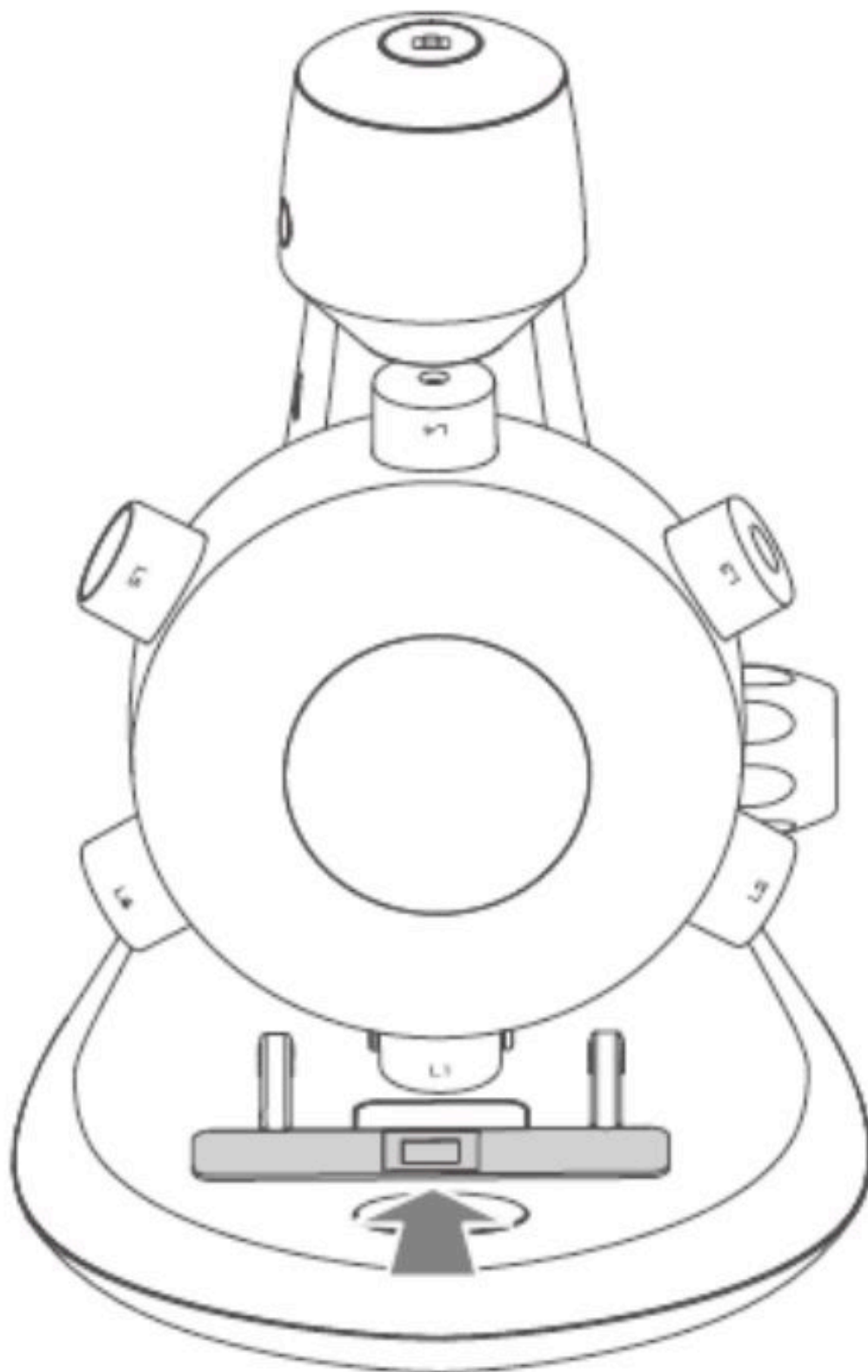

OPERAZIONI PRINCIPALI

Selezione della sorgente luminosa

Il microscopio digitale è dotato di due sorgenti luminose, una sopra e una sotto il piano porta-preparato, che forniscono rispettivamente illuminazione incidente e trasmessa.

Quando l'unità è collegata ad un computer e il programma in dotazione viene avviato, una delle due luci si accenderà.

Premere il selettore della luce per passare alla modalità di illuminazione desiderata. La luce si spegnerà automaticamente chiudendo il programma.

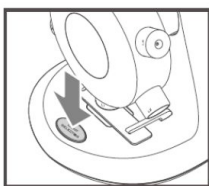

Premere una volta per cambiare la modalità di illuminazione

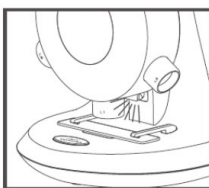

Illuminazione incidente

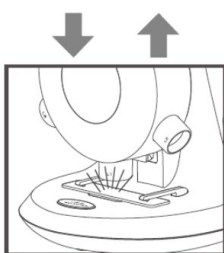

Illuminazione trasmessa

Selezione della potenza di ingrandimento

Il portaobiettivi può essere ruotato sia in senso orario sia in senso antiorario.

Prendendo come esempio l'obiettivo meno potente, L1: ruotare il portaobiettivi in modo che L1 si trovi direttamente sopra il preparato. Quando l'obiettivo sarà allineato correttamente, si sentirà un clic.

Ruotare il portaobiettivi per selezionare l'ingrandimento desiderato.

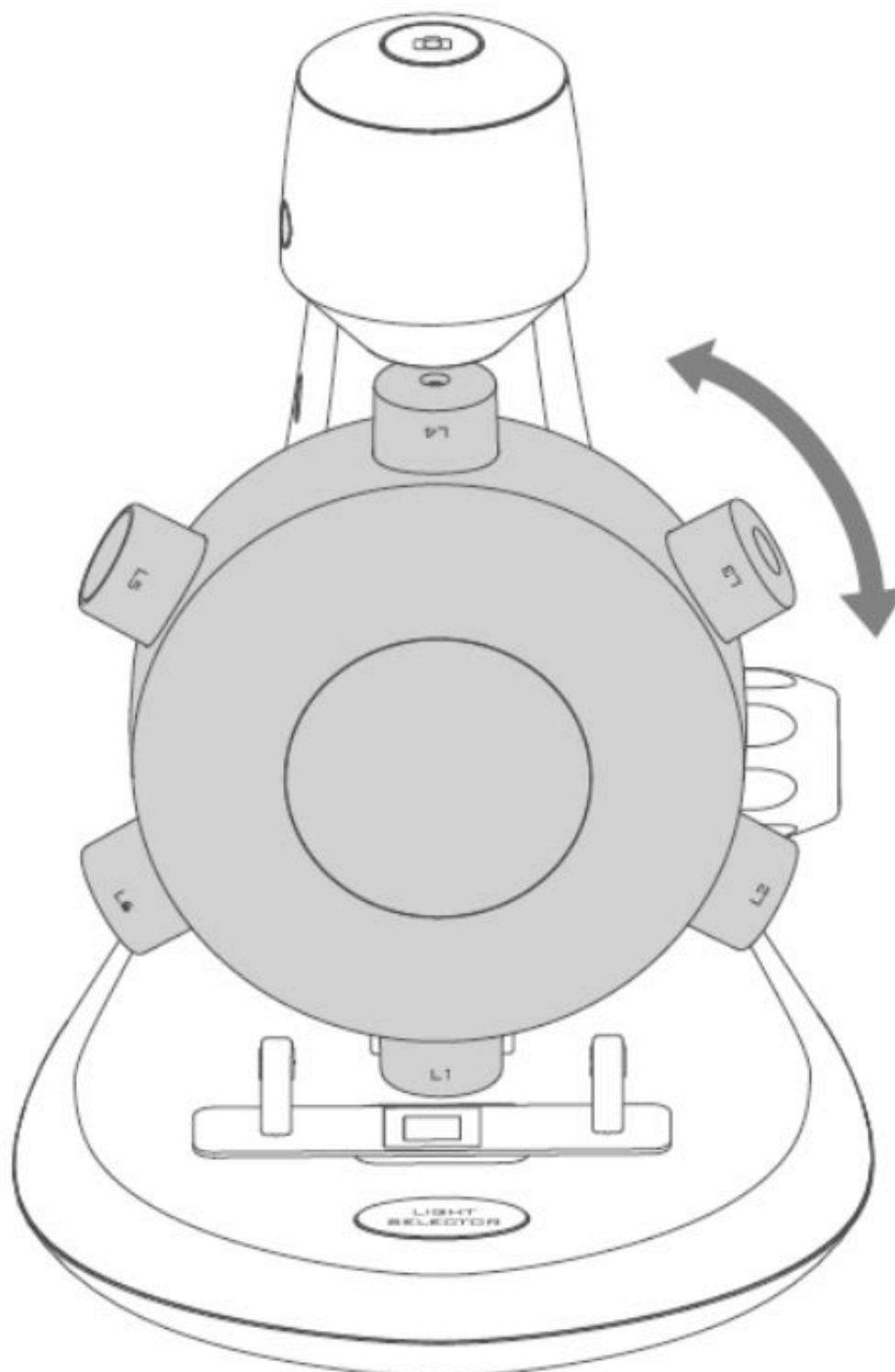

Messa a fuoco

Ruotare la manopola di messa a fuoco in senso orario o antiorario fino a quando l'immagine sarà nitida.

Nota: Accertarsi che non ci siano ostacoli e non urtare il vetrino quando il portaobiettivi viene abbassato per la messa a fuoco.

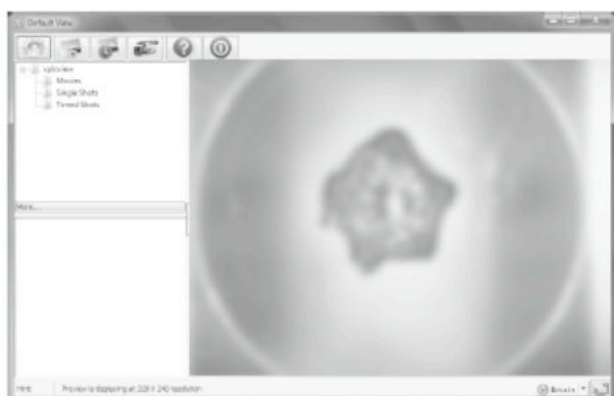
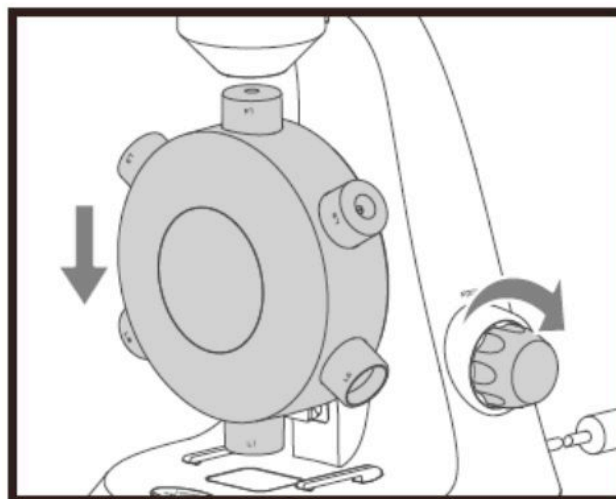
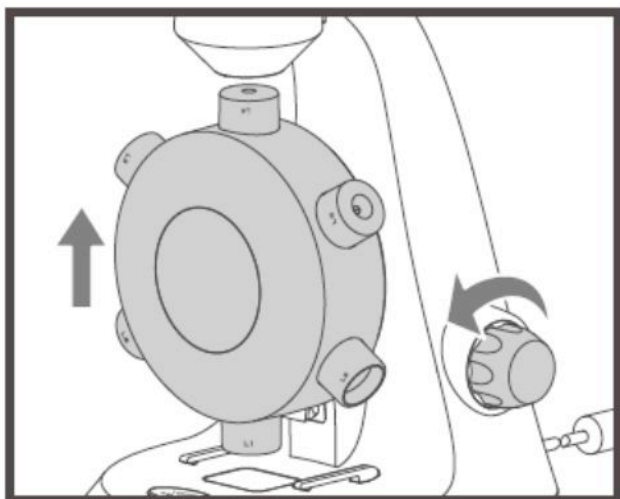

Istantanee

Premere il pulsante di scatto per acquisire un'istantanea.

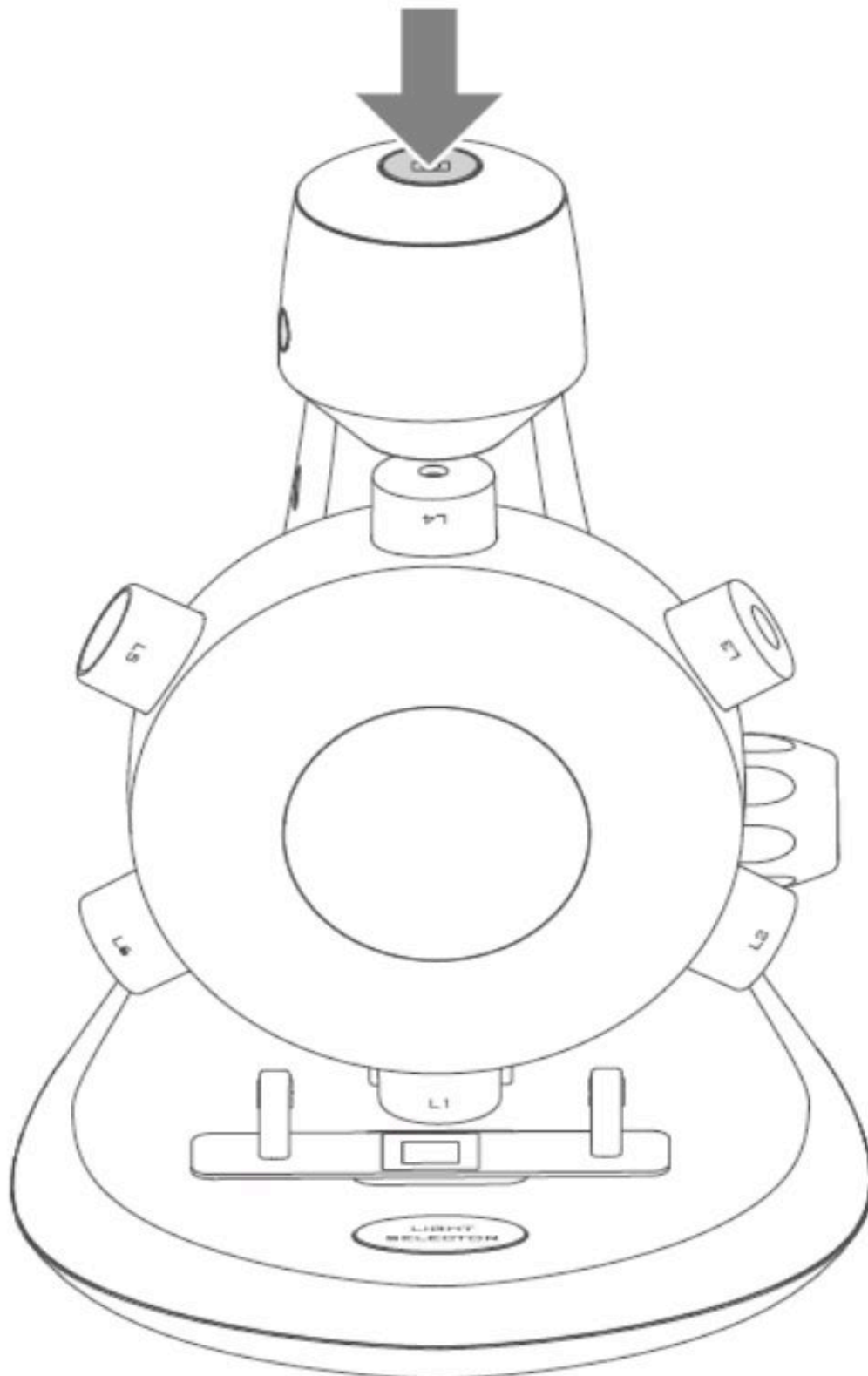

USO DEL PROGRAMMA XPLOVIEW

Menu pulsanti

Queste sono le icone del menu pulsanti:



Accesso al **Menu Impostazioni Sistema** (vedi il menu di impostazioni del sistema a pagina 19).



Acquisizione schermata.



Per avviare e terminare la funzione di **scatto temporizzato**. Le immagini saranno acquisite a intervalli regolari (vedi menu di impostazioni del sistema a pagina 20 per istruzioni su come regolare la frequenza e la durata).



Per avviare e terminare **registrazione video**.



Informazioni sul programma. Queste informazioni possono essere utili ai fini dell'aggiornamento del programma.



Chiusura del programma.

Vista a schermo intero

Per attivare la vista a schermo intero, fare clic sul corrispondente pulsante <  > situato nell'angolo in basso a destra della schermata del programma xplview.

Per uscire dalla modalità di vista a schermo intero, fare doppio clic sulla schermata oppure premere il pulsante "Esc" della tastiera.



Rotazione/Capovolgimento dell'immagine

Fare clic sul pulsante <  Rotate > per ruotare o capovolgere l'immagine.

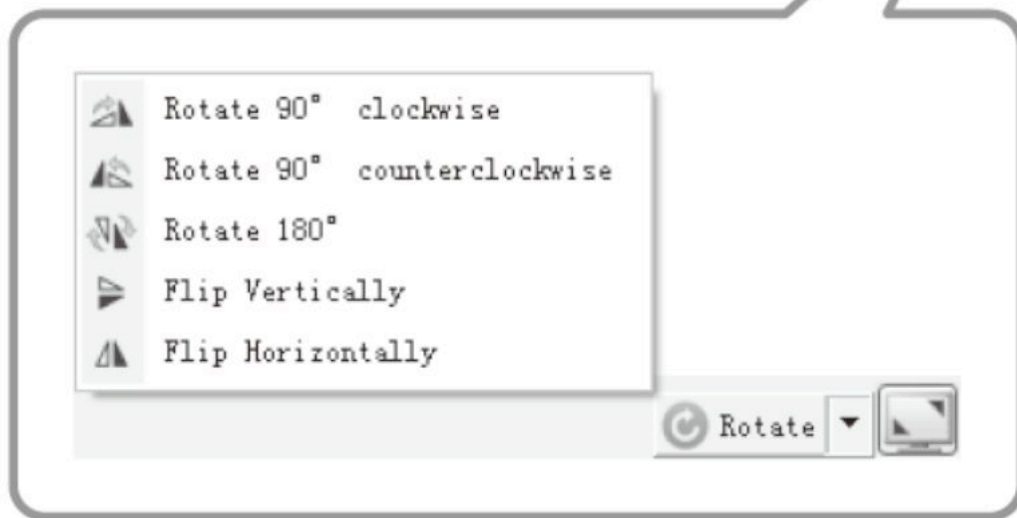
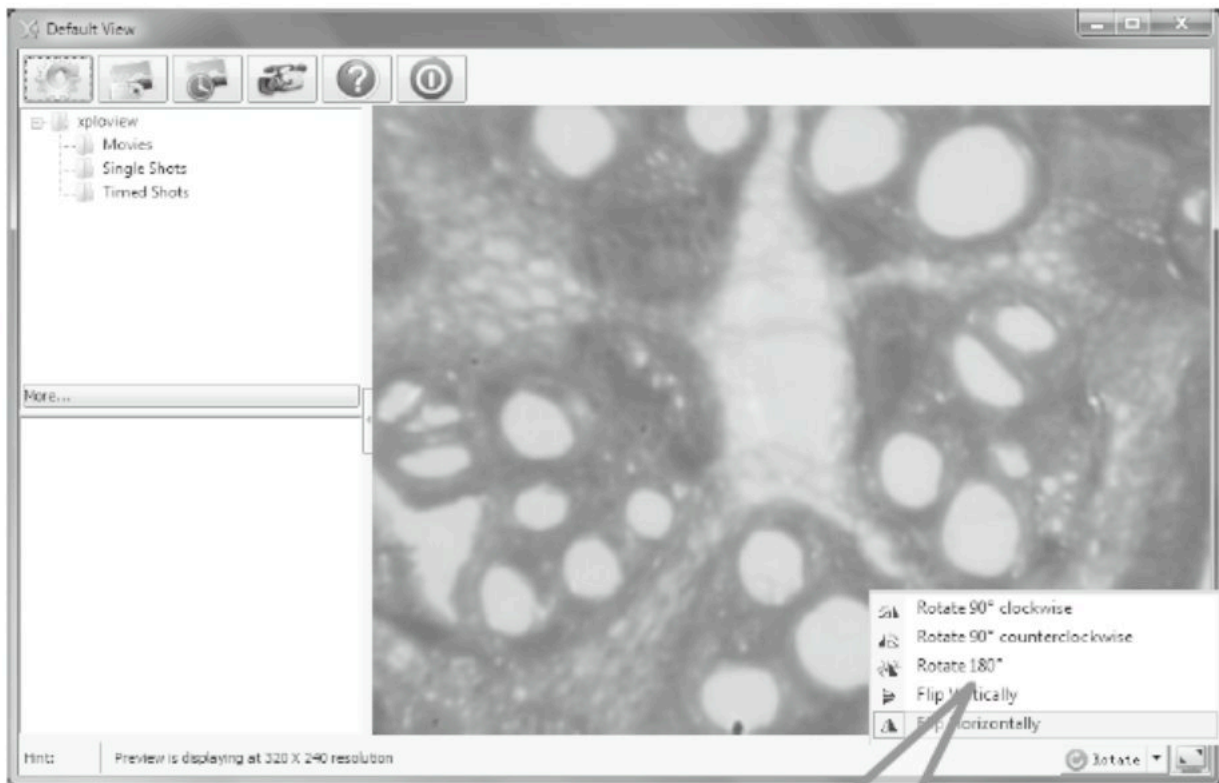

Menu di impostazioni del sistema

La prima volta che il programma xploview viene avviato, il sistema caricherà le impostazioni predefinite. Tali impostazioni potranno essere modificate manualmente nel menu di impostazioni del sistema.

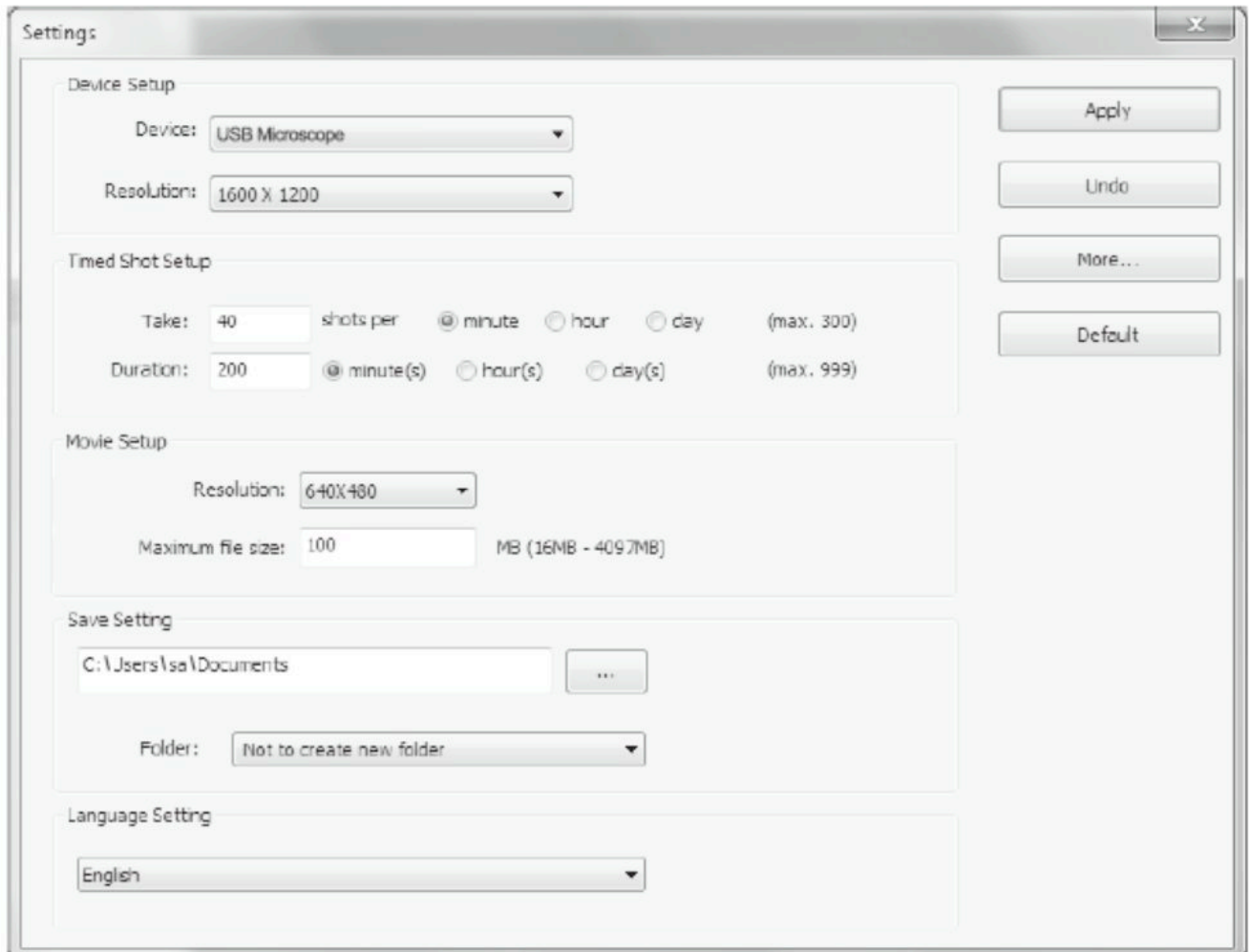

Configurazione dell'unità

Se l'immagine acquisita dal microscopio digitale non è visualizzata automaticamente, è possibile modificare tale impostazione dal menu a discesa "Device".

La risoluzione delle immagini acquisite può essere modificata nel menu a discesa "Resolution".



The screenshot shows a 'Device Setup' window with two dropdown menus. The first menu is labeled 'Device:' and is set to 'USB Microscope'. The second menu is labeled 'Resolution:' and is set to '1600 X 1200'.

Impostazione scatto temporizzato

Questa opzione consente di modificare la frequenza e la durata dell'acquisizione automatica delle immagini.

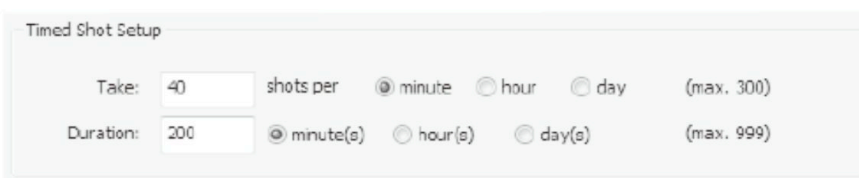

The screenshot shows a 'Timed Shot Setup' window. It has two rows of controls. The first row is 'Take: 40 shots per' with radio buttons for 'minute' (selected), 'hour', and 'day', and a '(max. 300)' label. The second row is 'Duration: 200' with radio buttons for 'minute(s)' (selected), 'hour(s)', and 'day(s)', and a '(max. 999)' label.

Impostazione video

La risoluzione dei video registrati può essere modificata nel menu "Resolution". È inoltre possibile impostare la dimensione massima dei file di ciascun video.

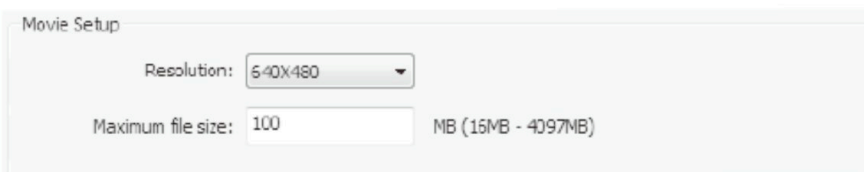

The screenshot shows a 'Movie Setup' window. It has two rows of controls. The first row is 'Resolution: 540X480' with a dropdown arrow. The second row is 'Maximum file size: 100 MB (15MB - 4097MB)' with a text input field.

Impostazioni di archiviazione

Quest'impostazione consente di modificare il percorso predefinito per le immagini o i video acquisiti.

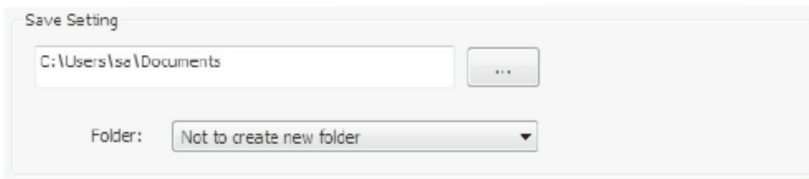

Save Setting

C:\Users\lse\Documents

Folder: Not to create new folder

Impostazione della lingua

Quest'impostazione consente di modificare la lingua del programma xploview.

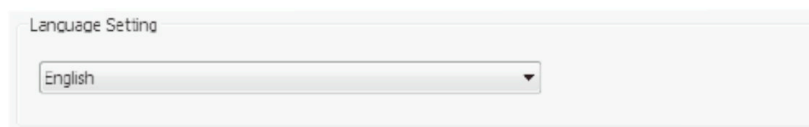

Language Setting

English

Impostazioni avanzate

Facendo clic sul pulsante "More..." sulla destra del menu delle impostazioni del sistema, sarà possibile regolare manualmente tutte le impostazioni delle immagini. Si noti che le impostazioni disponibili possono differire in base al sistema operativo.

Computer basato su Windows

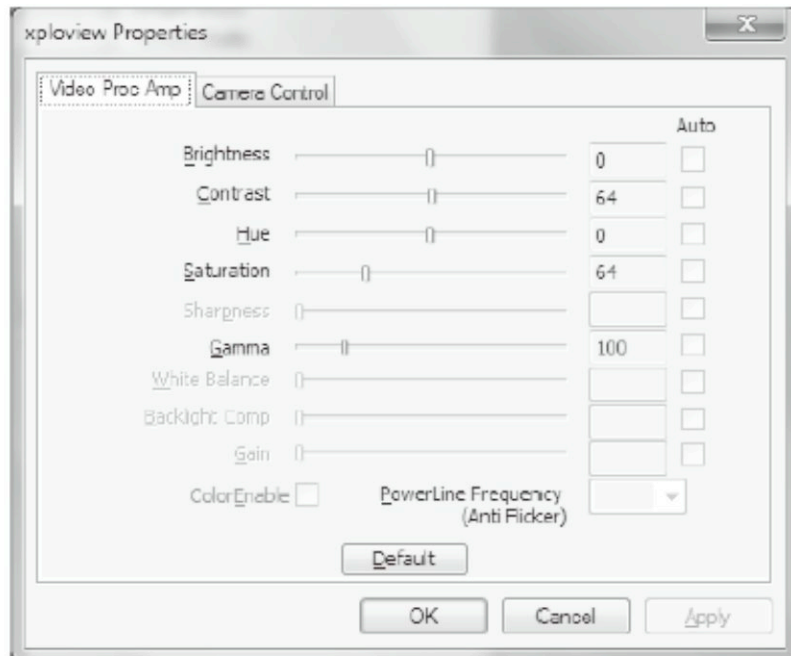

Computer basato su Mac OS



Immagine salvate

Con il programma xploview aperto, è possibile localizzare la cartella con i file salvati facendo clic sul pulsante "More..." situato sul lato sinistro della schermata principale del programma.

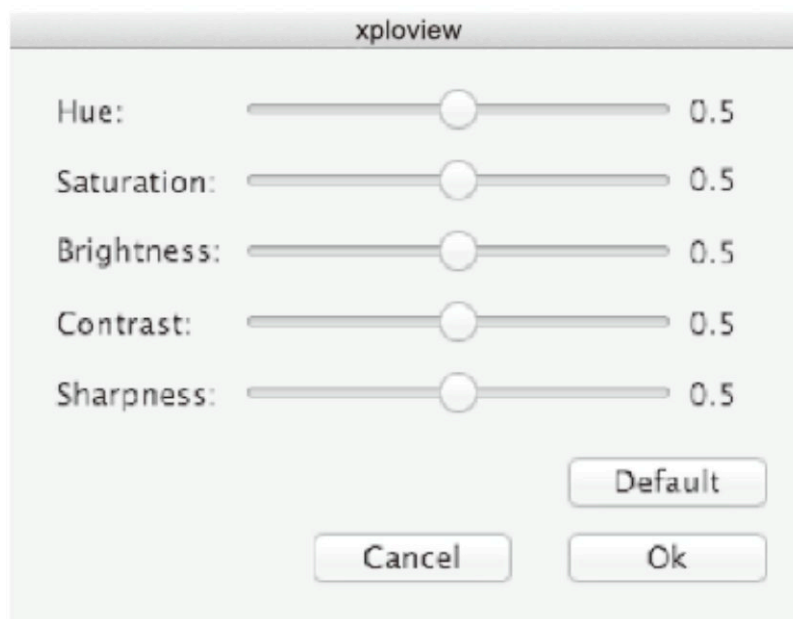
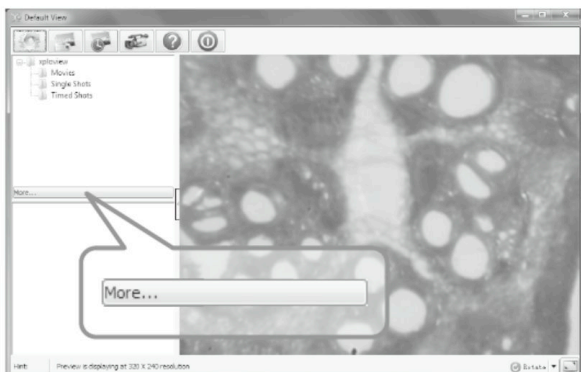

Disinstallazione del programma xploview

Computer basato su Windows

Selezionare "Disinstalla" dal menu di avvio (Start > Tutti i programmi > xploview > Disinstalla).

Computer basato su Mac OS

Trascinare l'icona del programma xploview dalla cartella delle "Applicazioni" al "cestino".

Dichiarazione di conformità FCC (valida solo negli Stati Uniti d'America)

Il presente dispositivo è conforme alla Sezione 15 della normativa FCC. L'utilizzo è subordinato alle seguenti due condizioni: (1) Questo dispositivo non può causare interferenze dannose, e (2) questo dispositivo deve accettare qualsiasi interferenza ricevuta, anche quelle che potrebbero causare un funzionamento indesiderato.

Cambiamenti o modifiche non espressamente approvate dalla parte responsabile per la conformità possono invalidare l'autorizzazione all'uso del prodotto.

Questo equipaggiamento è stato testato ed è risultato a norma con i limiti di Classe B dei dispositivi digitali, come indicato nella sezione 15 del regolamento FCC. Questi limiti sono progettati per fornire una ragionevole protezione contro le interferenze dannose in installazioni residenziali. Questa attrezzatura genera e può irradiare onde in radio frequenza e, se non installata e utilizzata secondo queste istruzioni, può provocare interferenze dannose alle comunicazioni radio. Tuttavia, non ci sono garanzie che non possano verificarsi interferenze in installazioni particolari. Se questo apparecchio provoca interferenze dannose alle ricezioni radiotelevisive, riscontrabili spegnendo e accendendo l'apparecchio, si consiglia di provare a correggerle adottando uno o più dei seguenti accorgimenti:

- Riorientare o riposizionare l'antenna di ricezione.
- Aumentare la distanza tra l'apparecchio e il ricevitore.
- Collegare il dispositivo a una presa su un circuito diverso da quello a cui è collegato il ricevitore.
- Consultare un rivenditore o un tecnico radio/TV.

Informazioni legali

Il presente documento è pubblicato senza alcuna garanzia. Le informazioni fornite sono da considerarsi accurate, ma potrebbero tuttavia contenere errori o imprecisioni. In nessun caso il produttore e i suoi distributori saranno responsabili per danni incidentali o consequenziali di alcun tipo, inclusi ma non limitati alla perdita di profitti o danni commerciali, derivanti dall'uso delle informazioni contenute nel presente documento.

Tutti i diritti riservati. Mac, Mac OS e OS X sono marchi di fabbrica di Apple Inc., registrati negli Stati Uniti d'America e in altri Stati. Windows è un marchio commerciale registrato di proprietà della Microsoft Corporation negli Stati Uniti d'America e in altri paesi. Tutti gli altri marchi di fabbrica e nomi di prodotti sono di proprietà dei rispettivi titolari.

reflecta[®]

DigiMicroscope Vario

Gebruiksaanwijzing
voor xploview v 3.2

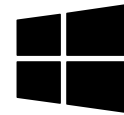

Android-App



DE

EN

FR

ES

IT

NL

NL

INHOUD

VOOR GEBRUIK	4
Belangrijke informatie	4
Verzorging en onderhoud	4
Waarschuwing.....	4
Productbeschrijving	5
Computervereisten	5
PRODUCT IN EEN OOGOPSLAG.....	6
Inhoud verpakking	6
Productoverzicht.....	7
Productspecificatie	8
AAN DE SLAG	9
Software-installatie	9
Aansluiten van het apparaat.....	10
Starten van de xploview software	10
Installeren van een specimenslide.....	11
BASIS	12
Selecteren van een lichtbron	12
Selecteren van een vergrotingsfactor	13
Scherpstellen	14
Maken van een momentopname	15
GEBRUIK VAN DE XPLOVIEW SOFTWARE	16
Knop menu.....	16
Weergave volledig scherm	17
Afbeelding draaien/spiegelen	18
Menu systeeminstellingen	19
Instelling apparaat	20
Instellingen getimedede opname	20
Instellingen film	20
Instellingen opslaan	21
Taalinstellingen.....	21
Geavanceerde instellingen	22
Opgeslagen bestanden	23
Verwijderen van de software xploview.....	23

VOOR GEBRUIK

Belangrijke informatie

Lees deze gebruikershandleiding voor gebruik van dit product aandachtig door en bewaar de handleiding voor toekomstig gebruik.

Verbeteringen en wijzigingen aan deze tekst die noodzakelijk zijn door typografische fouten of verbeteringen aan de softwareapparatuur kunnen op elk moment plaatsvinden zonder voorafgaande kennisgeving.

Verzorging en onderhoud

- Vermijd trillingen, schokken en druk door, bijv., het laten vallen van de microscoop.
- Houd het apparaat droog en bescherm het tegen water of damp.
- Laat uw apparaat niet achter in een plek met een extreem hoge of lage temperatuur.
- Raak het apparaat niet met een natte hand aan omdat dit het apparaat mogelijk kan beschadigen of een elektrische schok kan teweegbrengen aan de gebruiker.
- Gebruik of bewaar dit apparaat niet in stoffige, vuile plekken, omdat bewegende onderdelen mogelijk beschadigd kunnen worden.
- Gebruik geen agressieve chemicaliën, oplosmiddelen of sterke reinigingsmiddelen om het apparaat schoon te maken. Maak het schoon met een zachte doek die licht is bevochtigd door een milde oplossing van zeep en water.

Waarschuwing

- Plaats de verlichte digitale microscoop niet op het oog, dit kan permanente oogschade veroorzaken.
- Probeer de digitale microscoop niet te openen of te ontmantelen.

Productbeschrijving

- Dit product verschilt van een traditionele optische microscoop waarbij je door een oculair kijkt, door de weergave van een vergrote afbeelding of live video op een computerbeeldscherm via een USB-aansluiting.
- Dit product heeft een geïntegreerde objectentorentje met zes verschillende objectlenzen. Bij het bekijken van de afbeelding op een 17" beeldscherm kan dit product speciemens vergroten met 100x, 200x, 300x, 400x, 500x en 600x. De vergroting is afhankelijk van de grootte van het gebruikte beeldscherm - des te groter het beeldscherm, des te hoger de vergroting.
- Opnames van de speciemens kunnen worden vastgelegd met de knop momentopname aan de bovenzijde van het apparaat. Live video's en momentopnames kunnen ook worden vastgelegd en opgeslagen op de computer met de meegeleverde software.

Computervereisten

Op Windows gebaseerde PC

Compatibele besturingssystemen

Windows 10 (32 bit of 64 bit)

Windows 8 (32 bit of 64 bit)

Windows 7 (32 bit of 64 bit)

Windows Vista (32 bit of 64 bit)

Windows XP SP2, SP3

USB

USB 2.0

Mac OS gebaseerde PC

Compatibele besturingssystemen

Mac OS X 10.5.6 - Mac OS X 10.11.x

USB

USB 2.0

PRODUCT IN EEN OOGOPSLAG

Inhoud verpakking

Digitale microscoop met
USB-kabel

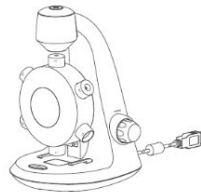

Lege speciemenslides x3
Geprepareerde slide met
katoenen specimen

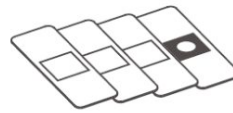

Pincet

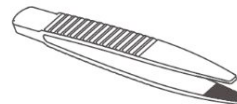

Cover lege speciemenslides

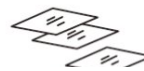

Installatie-CD



Gebruiksaanwijzing



Druppelpipet



Productoverzicht

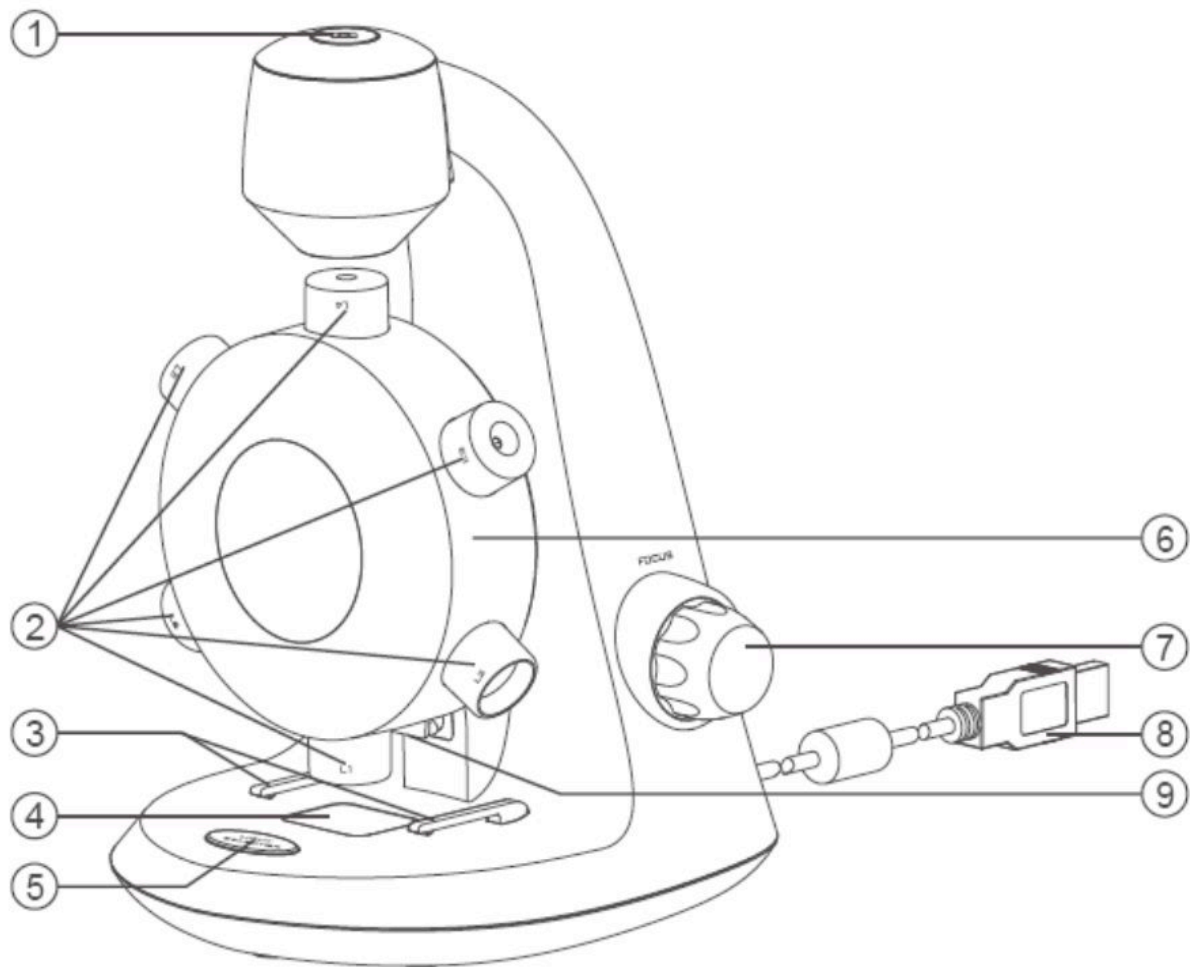

1. Toets momentopname
2. Objectieven
3. Specimenslideclip
4. Specimenplek
5. Keuzeschakelaar licht
6. Objectieventoren
7. Knop scherpstellen
8. USB-kabel
9. LED

Productspecificatie

Verbindingstype	USB 2.0
Effectief observatiegebied	L1 = 3,6 x 2,7 mm L2 = 1,8 x 1,4 mm L3 = 1,2 x 0,9 mm L4 = 0,9 x 0,7 mm L5 = 0,7 x 0,5 mm L6 = 0,6 x 0,45 mm
Vergrotingsfactor (bekeken op een 17" beeldscherm)	L1 = 100x L2 = 200x L3 = 300x L4 = 400x L5 = 500x L6 = 600x
Verlichting	LED
Stroomvoorziening	5V $\overline{\text{---}}$ 250mA (via USB)
Sensor	CMOS
Maximale resolutie momentopname	1600 x 1200 pixels (UXGA)
Maximale resolutie video-opnames	640 x 480 pixels (VGA)
Afmetingen	130 mm x 154 mm x 208 mm
Gewicht	369 gram

AAN DE SLAG

Software-installatie

Op Windows gebaseerde PC

- Plaats de meegeleverde CD in de CD-ROM van de computer.
- Dubbelklik op het pictogram "xploview v3.2.xx.exe" < > op de CD.
- Volg de installatiewizard van xploview om de applicatiesoftware te installeren voor de digitale microscoop.

Mac OS gebaseerde PC

- Plaats de meegeleverde CD in de CD-ROM van de computer.
- Dubbelklik op het pictogram "xploview v3.2.xx.dmg" < > op de CD.
- Sleep de pictogram xploview < > naar de map Toepassingen.

Aansluiten van het apparaat

Sluit het apparaat aan op de computer met de meegeleverde USB-kabel.

Starten van de xploview software

Op Windows gebaseerde PC

De xploview software kan worden gestart door dubbel te klikken op het pictogram <  > vanaf de bureaublad, of vanuit het startmenu.

Mac OS gebaseerde PC

De xploview software kan worden gestart door dubbel te klikken op het pictogram <  > vanuit de map Toepassingen.

Opmerking

Wanneer het apparaat voor de eerste keer aan de computer wordt verbonden zal automatisch een stuurprogramma worden geïnstalleerd door Windows of Mac OS. Dit proces kan enkele minuten duren.

Elke keer wanneer de xploview software wordt gestart zal het apparaat automatisch opstarten. Anders kan het apparaat worden geselecteerd vanaf de sectie apparaatinstellingen van het menu systeeminstellingen.

Installeren van een specimentslide

Plaats een geprepareerde specimentslide op de specimenplek en schuif deze in de specimentslideclips zodat de clips de specimentslide goed vast houdt.

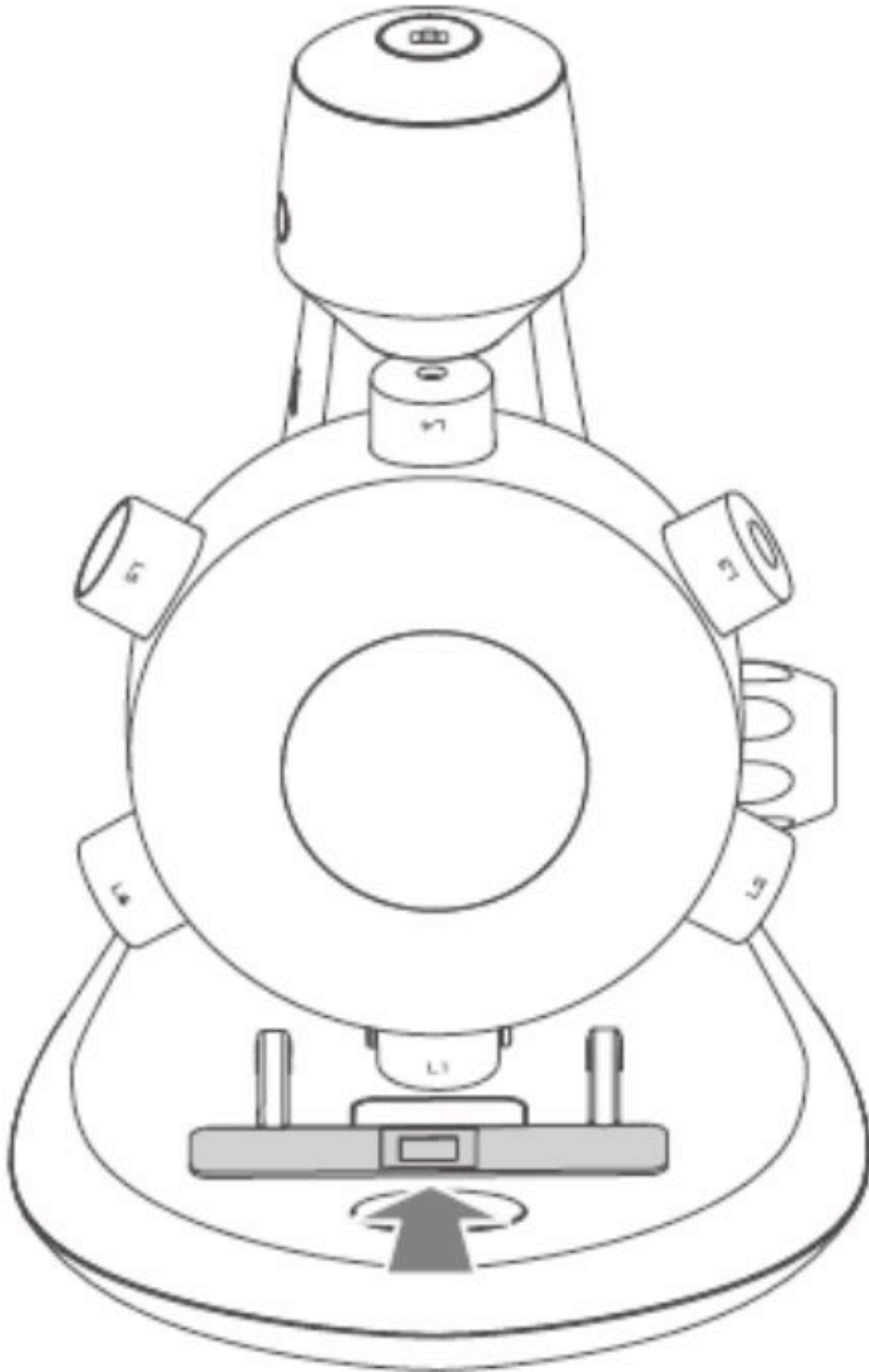

BASIS

Selecteren van een lichtbron

De digitale microscoop bevat twee lichtbronnen. Eén gelegen boven de specimenplek en één beneden waardoor respectievelijk incidentele en uitgezonden licht wordt verkregen.

Wanneer het apparaat is verbonden aan een computer zal wanneer de software wordt uitgevoerd één van de lichten worden ingeschakeld.

Druk eenmaal de keuzeschakelaar licht om over te schakelen naar het gewenste verlichtingssysteem. Bij het sluiten van de software zal het licht automatisch uitschakelen.

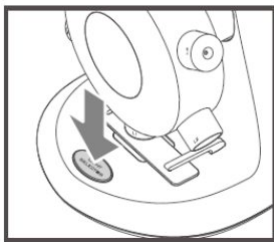

Druk eenmaal om het verlichtingssysteem te schakelen

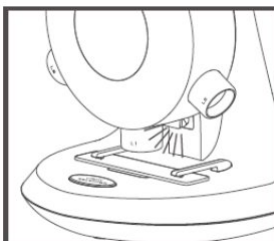

Incidentele verlichting

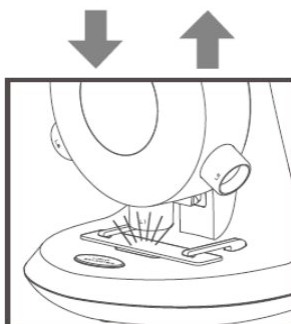

Verzonden verlichting

Selecteren van een vergrotingsfactor

De objectieventoren kan op meerdere manieren worden gedraaid - met de klok mee of tegen de klok in.

Terwijl de minst krachtige objectief L1 wordt genomen, als voorbeeld: draai de objectieventoren op een dergelijke manier zodat L1 direct boven de specimen is. Wanneer de objectief goed is uitgelijnd zul je een 'klik' voelen.

Draai de objectieventoren om de gewenste vergroting te selecteren.

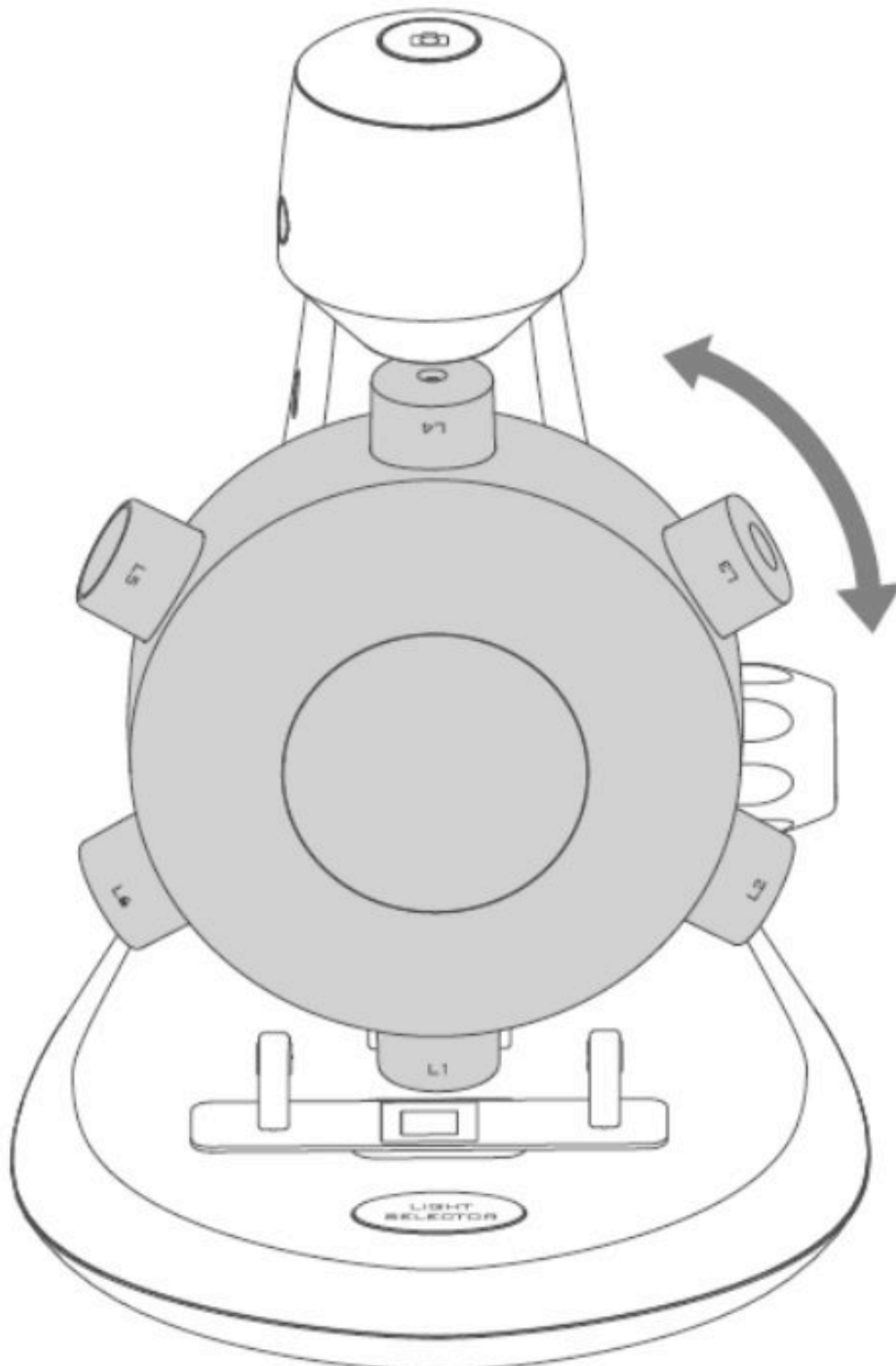

Scherpstellen

Draai de knop voor scherpstellen met de klok mee of tegen de klok in totdat de afbeelding helder is.

Opmerking: Zorg ervoor dat de objectief vrij is van obstakels en de speciemenslide niet raakt tijdens het verlagen van de objectieventoren tijdens het scherpstellen.

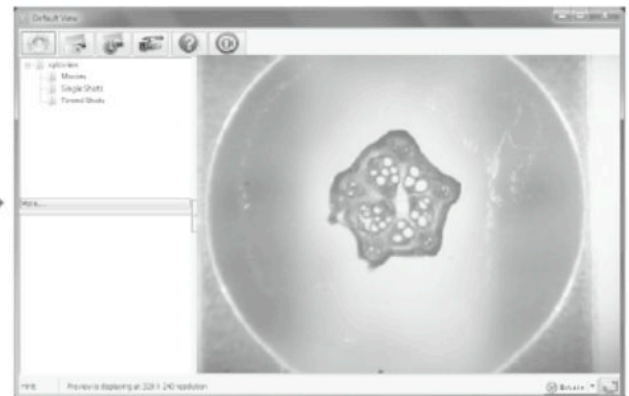
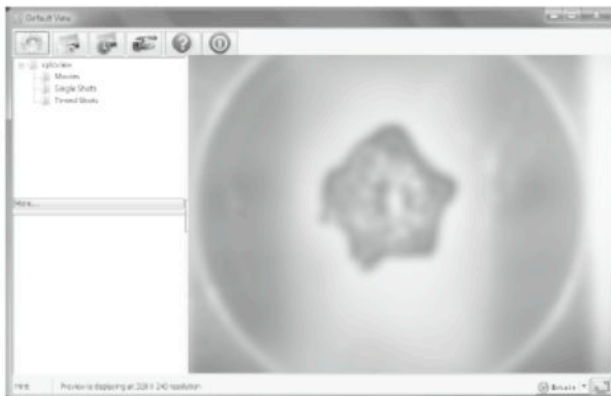
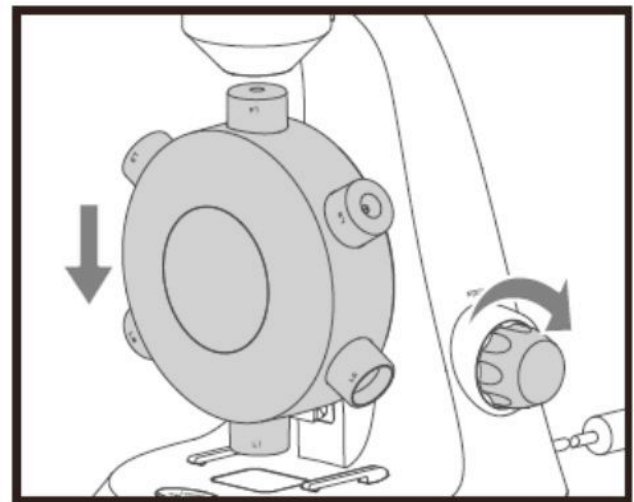
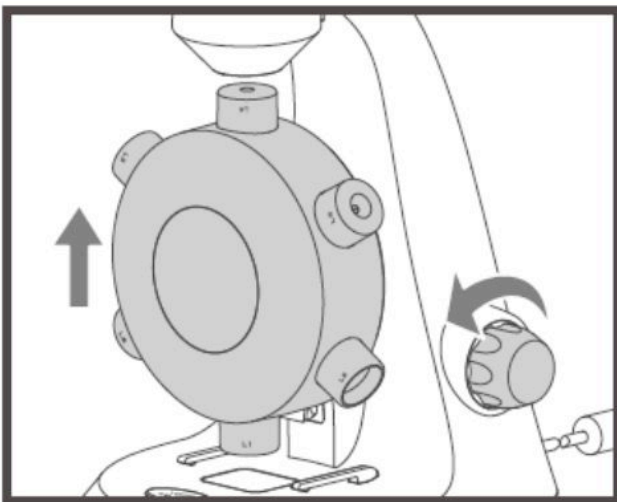

Maken van een momentopname

Druk op de knop momentopname om een momentopname te maken.

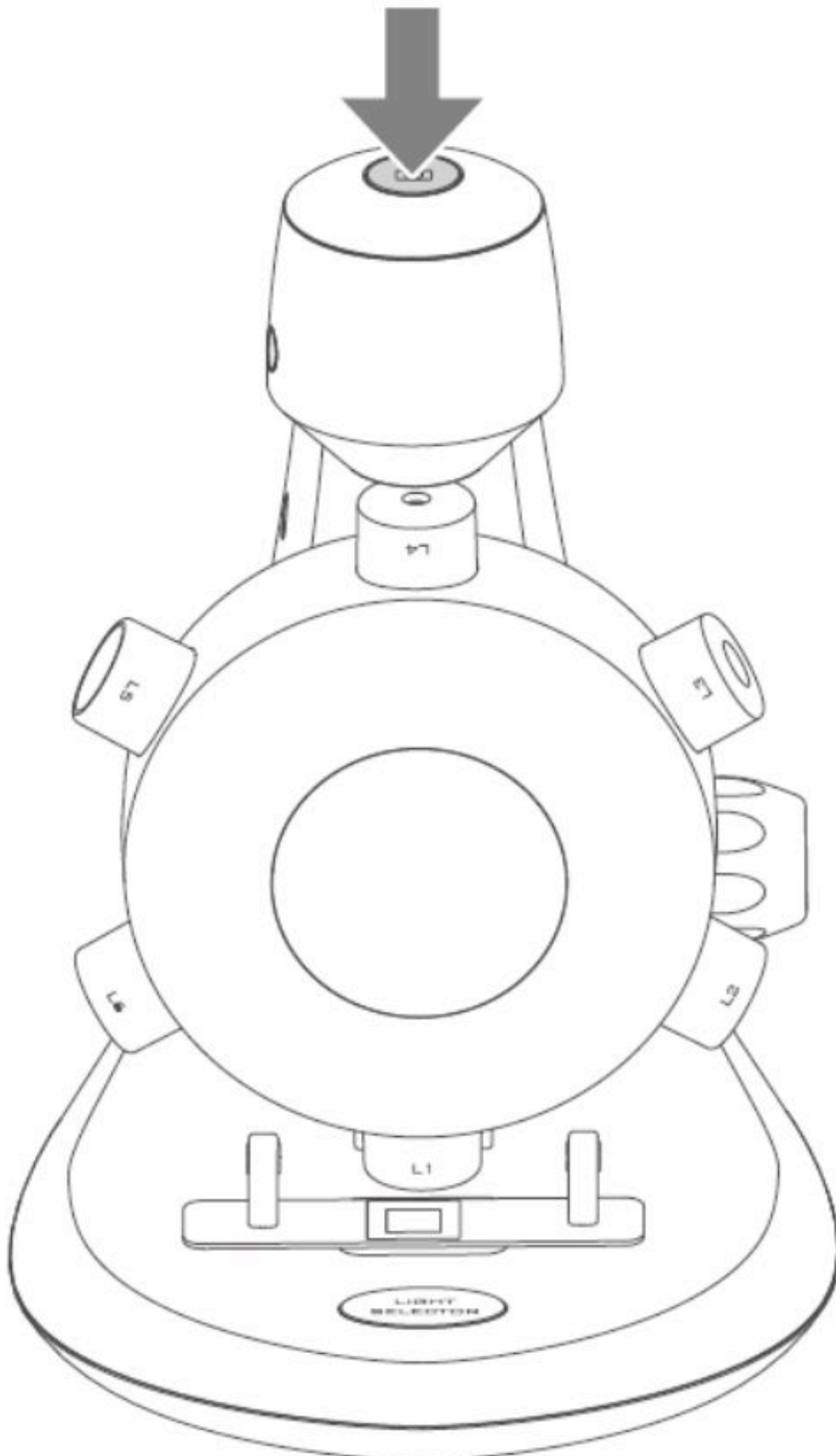

GEBRUIK VAN DE XPLOVIEW SOFTWARE

Knop menu

De pictogrammen van de knop menu:



Open **menu systeeminstellingen** (zie systeeminstellingen op pagina 19).



Maak een momentopname van het scherm.



Op een **getimedede opname** te stoppen en starten. Afbeeldingen zullen op een regelmatig interval worden opgenomen (zie systeeminstellingen op pagina 20 om de frequentie en duur aan te passen).



Om een **video-opname** te starten en stoppen.



Informatie van de software. Deze informatie is misschien nuttig tijdens het bijwerken van de software.



Afsluiten van de software.

Weergave volledig scherm

Om de modus volledig scherm te activeren, klik op de knop volledig scherm in de rechteronderzijde van het scherm van de xploview software.

Om de modus volledig scherm te sluiten, dubbelklik op het scherm of druk op de knop "Esc" op het toetsenbord.

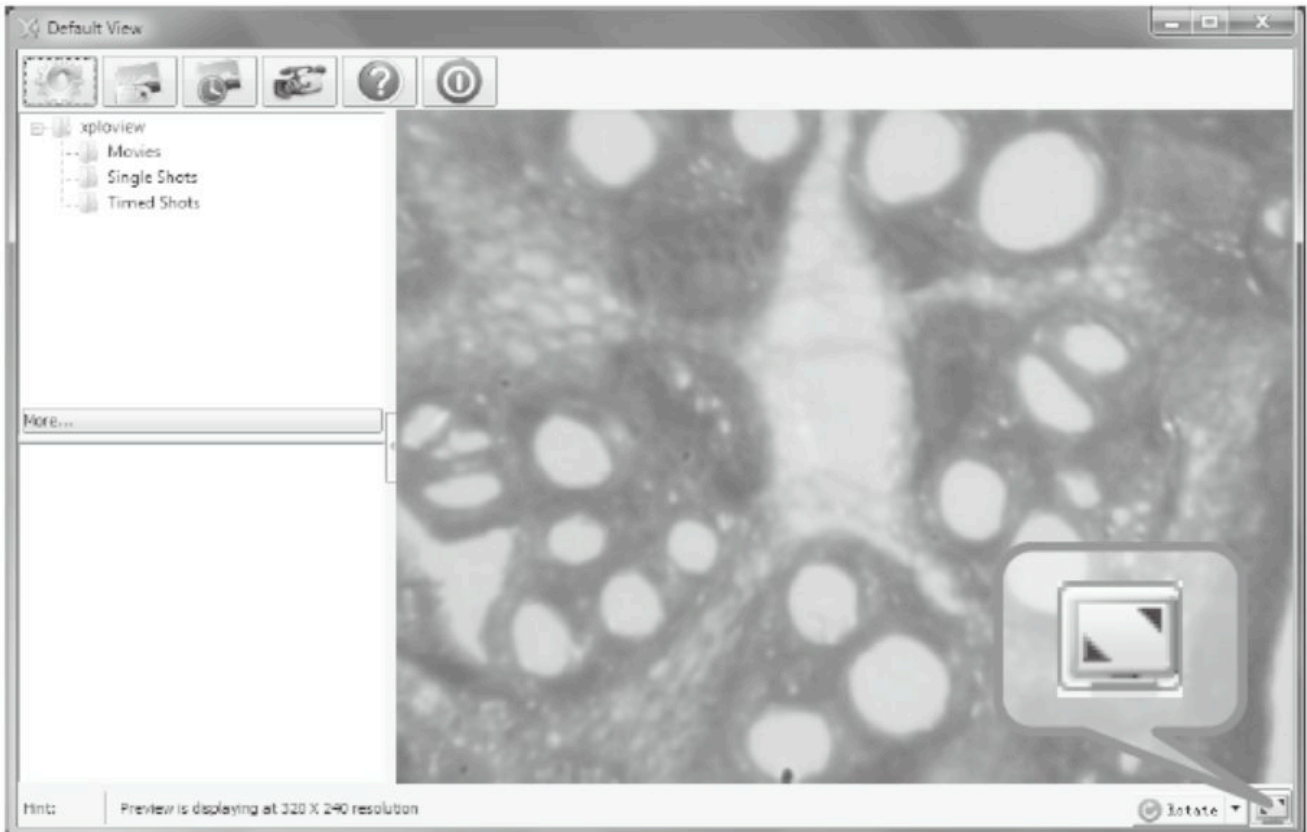

Afbeelding draaien/spiegelen

Klik op de knop <  Rotate > om de afbeelding te draaien of te spiegelen.

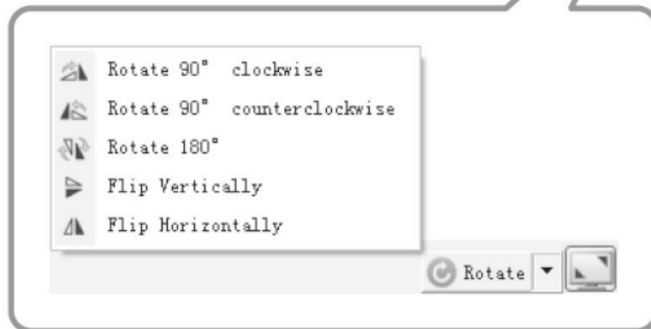
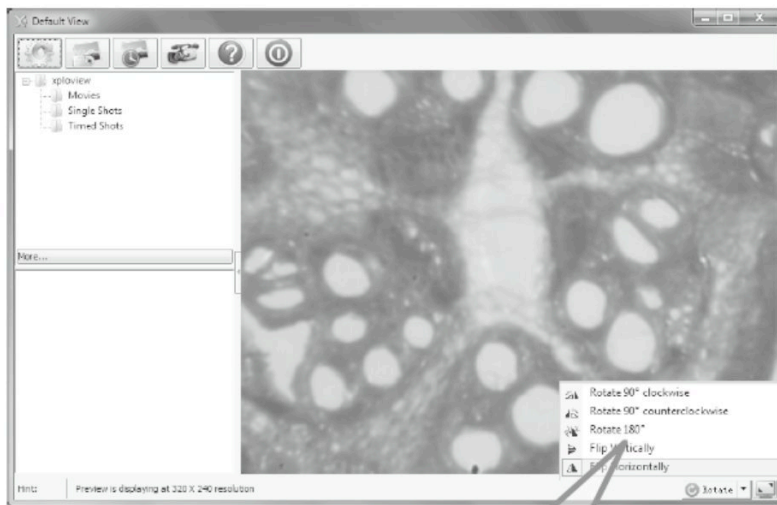

Menu systeeminstellingen

De eerste keer dat de software xploview wordt gestart zullen de standaardinstelling worden geladen. U kunt deze instellingen handmatig aanpassen in het menu systeeminstellingen.

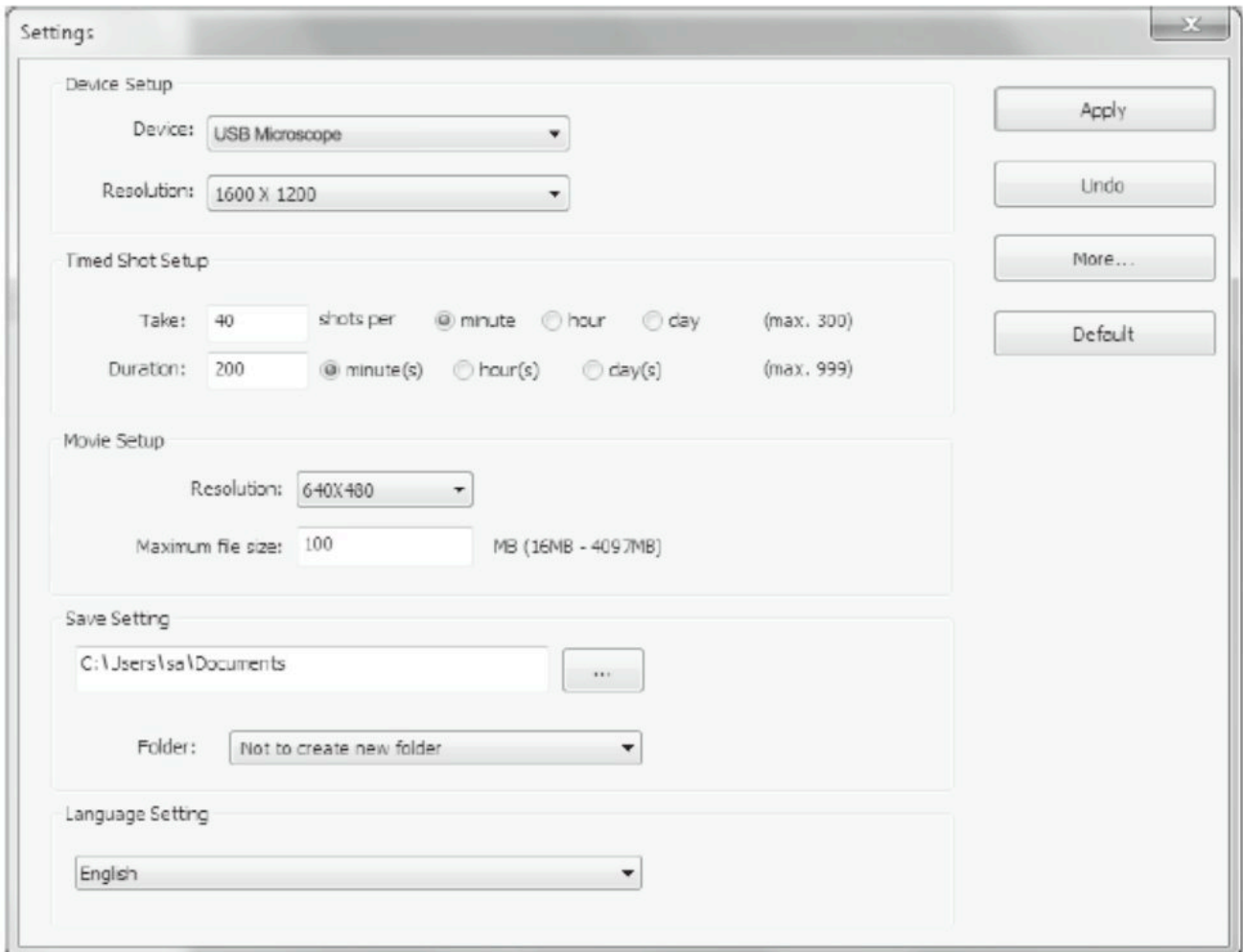

Instelling apparaat

Als de afbeelding die is gemaakt door de digitale microscoop niet standaard wordt weergegeven, kunt u dit veranderen door deze te selecteren in het drop-downmenu van "Device".

De resolutie van de afbeeldingen die u maakt kunnen worden veranderd in het drop-downmenu van "Resolution".



Device Setup

Device: USB Microscope

Resolution: 1600 X 1200

Instellingen getimedede opname

De frequentie en duur van de automatische opname van afbeeldingen kunnen bij deze optie worden aangepast.

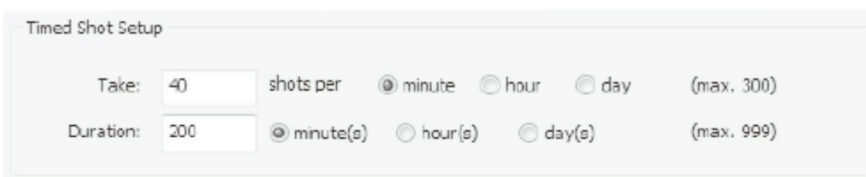

Timed Shot Setup

Take: 40 shots per minute hour day (max. 300)

Duration: 200 minute(s) hour(s) day(s) (max. 999)

Instellingen film

De resolutie van films die u maakt kan worden aangepast in het menu "Resolution". U kunt ook de maximale bestandsgrootte aanpassen van elke video.

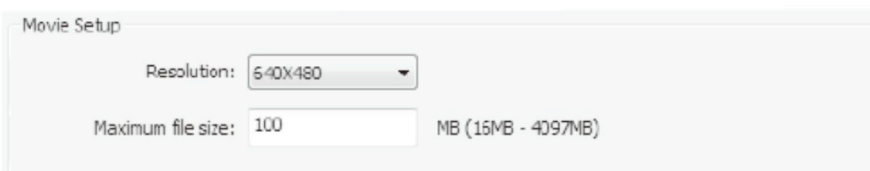

Movie Setup

Resolution: 640X480

Maximum file size: 100 MB (16MB - 4097MB)

Instellingen opslaan

De standaardlocatie voor opgenomen afbeeldingen of video's kan bij deze optie worden aangepast.

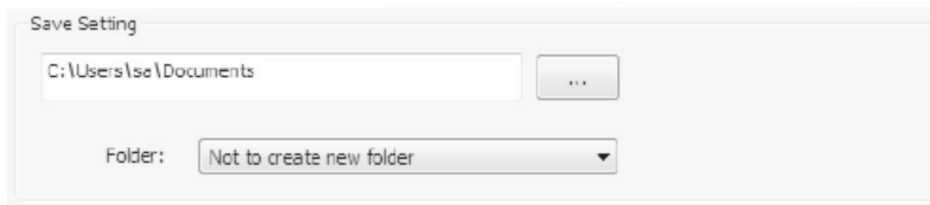

Save Setting

C:\Users\se\Documents

Folder: Not to create new folder

Taalinstellingen

De taal van de xploview software kan bij deze optie worden aangepast.

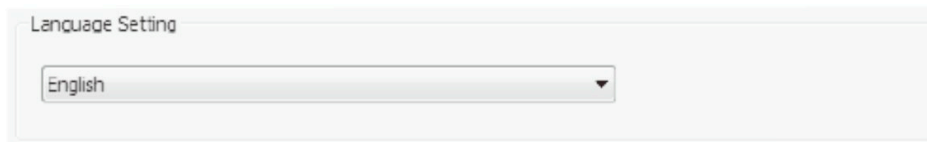

Language Setting

English

Geavanceerde instellingen

Door de klikken op de knop "More..." aan de rechterzijde van het menu systeeminstellingen kunt u handmatig alle afbeeldingsinstellingen aanpassen. Let erop dat de instellingen anders kunnen zijn, afhankelijk van uw besturingssysteem.

Op Windows gebaseerde PC

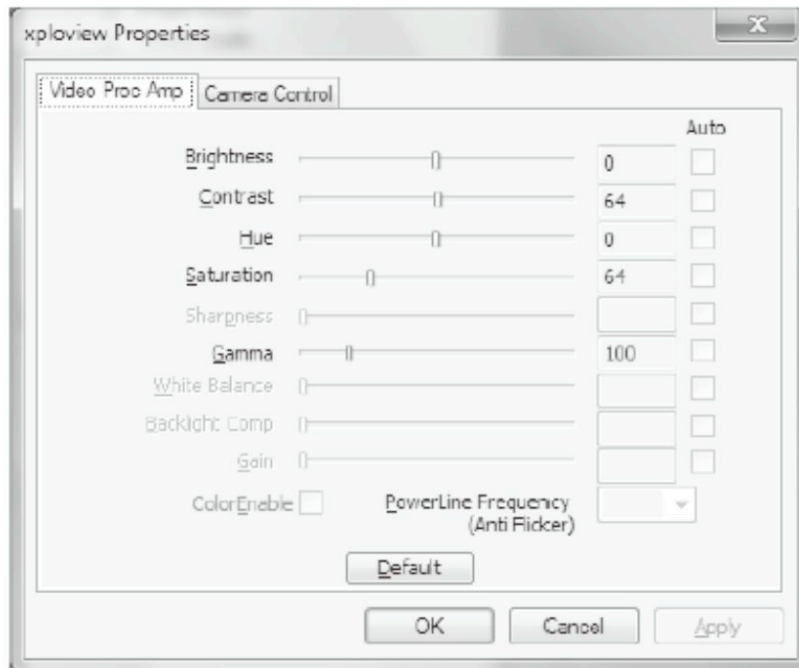

Mac OS gebaseerde PC

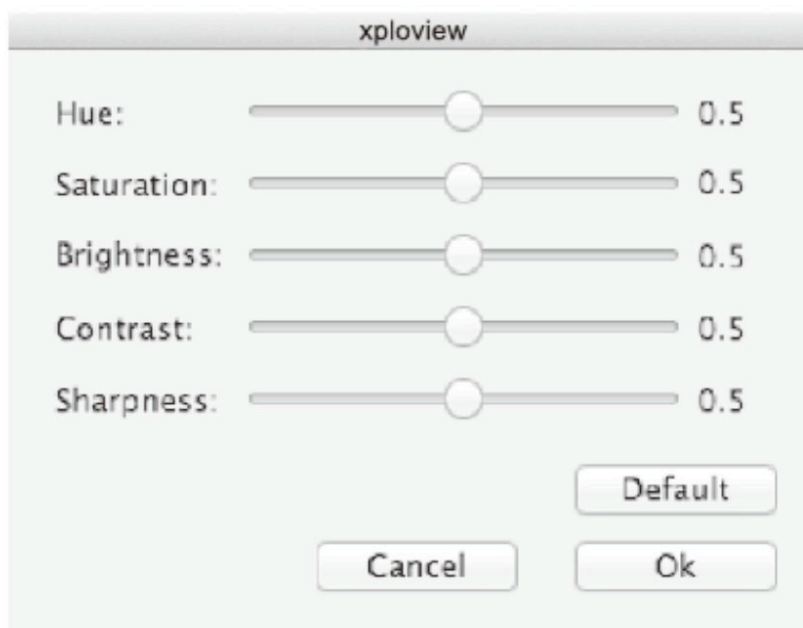

Opgeslagen bestanden

Met de xplview software geopend kunt u de map met opgeslagen bestanden vinden door te klikken op de knop "More..." aan de rechterzijde van het venster van de software.

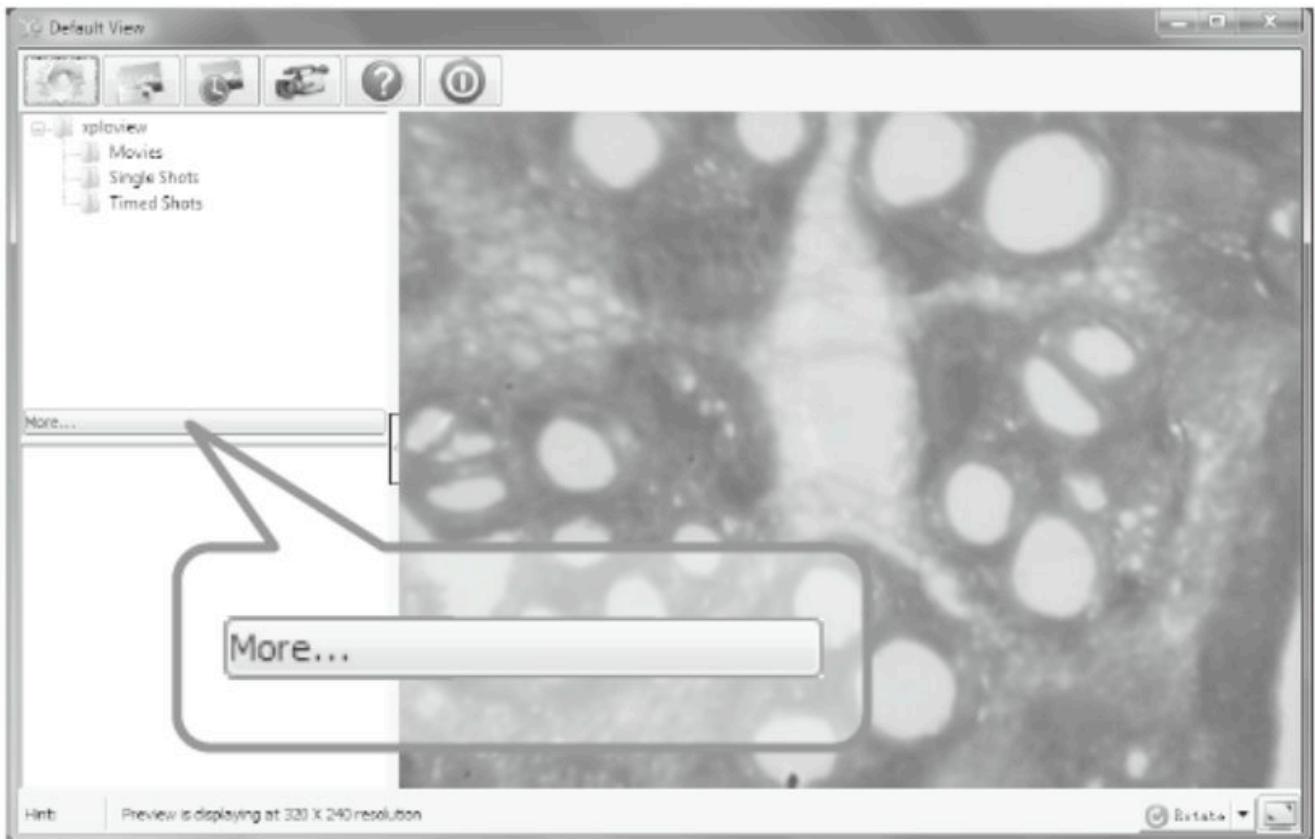

Verwijderen van de software xplview

Op Windows gebaseerde PC

Selecteer "Verwijderen" uit het startmenu (Start > Alle Programma's > xplview > Verwijderen).

Mac OS gebaseerde PC

Sleep het softwarepictogram van xplview vanuit de map "Toepassingen" naar de "Prullenbak".

Verklaring van de naleving van FCC (alleen VS)

Dit apparaat voldoet aan deel 15 van de FCC-voorschriften. De werking is onderhevig aan de volgende twee voorwaarden: (1) Dit apparaat mag geen schadelijke interferentie veroorzaken, en (2) dit apparaat moet ongevoelig zijn voor storingen, met inbegrip van interferentie die ongewenste werking kan veroorzaken.

Wijzigingen of aanpassingen die niet uitdrukkelijk zijn goedgekeurd door de partij die verantwoordelijk is voor naleving kunnen de bevoegdheid ongeldig maken van de gebruiker bij het gebruik van deze apparatuur.

Deze apparatuur is getest en er is vastgesteld dat hij voldoet aan de limieten voor een digitaal apparaat van Klasse B, volgens Deel 15 van de voorschriften van de FCC. Deze limieten zijn vastgesteld om een redelijke bescherming tegen schadelijke storingen in een huisinstallatie te bieden. Deze apparatuur genereert, gebruikt en kan radiofrequentie-energie uitstralen en indien niet volgens de instructies geïnstalleerd en gebruikt, kan schadelijke interferentie ontstaan voor de radiocommunicatie. Dit is echter geen garantie dat in een bepaalde installatie geen storing zal optreden. Indien deze apparatuur schadelijke storing in radio- of televisieontvangst veroorzaakt, die kan worden vastgesteld door de apparatuur in en uit te schakelen, wordt de gebruiker gevraagd te proberen om de storing te verhelpen middels één of meer van de volgende maatregelen:

- Richt of verplaats de ontvangstantenne opnieuw.
- Vergroot de afstand tussen de apparatuur en ontvanger.
- Sluit het apparaat aan op een stopcontact op een circuit dat anders is dan diegene waaraan de ontvanger is verbonden.
- Raadpleeg de verkoper of een ervaren radio/tv-monteur.

Juridische Informatie

Dit document is gepubliceerd zonder enige garantie. Terwijl de verstrekte informatie wordt verondersteld juist te zijn, kan het fouten of onnauwkeurigheden bevatten. In geen geval is de fabrikant of haar distributeurs aansprakelijk voor incidentele of gevolgschade van welke aard dan ook, inclusief maar niet beperkt tot verlies van winst of commerciële, voortvloeiend uit het gebruik van de informatie in dit document.

Alle rechten voorbehouden. Mac, Mac OS en OS X zijn handelsmerken van Apple Inc., gedeponeerd in de V.S. en andere landen. Windows is een gedeponeerd handelsmerk van Microsoft Corporation in de Verenigde Staten en andere landen. Alle andere handelsmerken zijn eigendom van hun respectievelijke eigenaars.