

Device handbook

SIRAX MM1400

Operating Instructions SIRAX MM1400



 CAMILLE BAUER

Camille Bauer Metrawatt AG
Aargauerstrasse 7
CH-5610 Wohlen/Switzerland

Tel: +41 56 618 21 11
Fax: +41 56 618 21 21

info@cbmag.com
www.camillebauer.com

Table of contents

1. Legal information	3
1.1 Safety and warning notices	3
1.2 Qualified personal	3
1.3 Intended use	3
1.4 Disclaimer of liability	3
1.5 Feedback	3
1.6 Repair work and modifications	3
1.7 Calibration and new adjustment	3
1.8 Cleaning	4
1.9 Disposal	4
1.10 Return	4
2. Introduction	4
2.1 Purpose of this document	4
2.2 Scope of supply	4
2.3 Further documents	4
3. Functional description	4
3.1 Available measurement data	5
3.2 Measurement parameter screen	6
3.3 Setup parameter screen	7
4. Mechanical mounting	8
4.1 Panel cut out	8
4.2 Mounting of the device	8
4.3 Demounting of the device	8
5. Electrical connections	9
5.1 General safety notes	9
5.2 Possible cross sections and tightening torques	9
5.3 Inputs	10
5.4 Power supply	11
5.5 Modbus interface RS485	11
6. Commissioning	11
7. Programming	12
7.1. Password Protection	12
7.1.1. Change Password	13
7.2. Menu selection	13
7.2.1 System Parameters Selection	13
7.2.2 Communication Parameter Selection	17
7.2.3 Reset Parameter Selection	18
7.2.4 Time Of Day Setup	19
7.2.5 Power Quality Setup	21
7.2.6 Clock Setup	22
7.2.7 Brightness & Contrast	22
7.2.8 RGB Color Code	23
8. Touch screen calibration	23
9. Phase Rotation Error screen	24
10. Run Hour	25
11. On Hour	25
12. Number of Interruption	25
13. Phasor Diagram	26
14. Technical data	27
14.1 Dimensional drawings	29
14.2 Connection and programming via RS485 (MODBUS RTU) interface	30
14.3 Connection and programming via Ethernet RJ45 (MODBUS RTU) interface	30
15. Interface Definition Modbus (RS485)	30
15.1 Accessing 3 X register for reading measured values	31
15.2 Accessing Sag, Swell, Over Current data through MODBUS	38
15.3 Accessing 3 X for reading Time Of Day data	42
15.4 Accessing TOD Zone wise Data of Last 31 days	45
15.5 Accessing 4 X register for reading & Writing	47
15.6 User Assignable Modbus Register	53

1. Legal information

1.1 Safety and warning notices

In this document safety and warning notices are used, which you have to observe to ensure personal safety and to prevent damage to property.



If the warning notice is not followed death or severe personal injury **will** result.



If the warning notice is not followed damage to property or severe personal injury **may** result.



If the warning notice is not followed the device **may** be damaged or **may** not fulfill the expected functionality.



The installation and commissioning should only be carried out by trained personnel. Check the following points before commissioning:

- that the maximum values for all the connections are not exceeded, see „Technical data“ section,
- that the connection wires are not damaged, and that they are not live during wiring,
- that the power flow direction and the phase rotation are correct.

The instrument must be taken out of service if safe operation is no longer possible (e.g. visible damage). In this case, all the connections must be switched off. The instrument must be returned to the factory or to an authorized service dealer.

It is forbidden to open the housing and to make modifications to the instrument. The instrument is not equipped with an integrated circuit breaker. During installation check that a labeled switch is installed and that it can easily be reached by the operators.

Unauthorized repair or alteration of the unit invalidates the warranty.



Please observe that the data on the type plate must be adhered to!

The national provisions have to be observed in the installation and material selection of electric lines!

1.2 Qualified personnel

The product described in this document may be handled by personnel only, which is qualified for the respective task. Qualified personnel have the training and experience to identify risks and potential hazards when working with the product. Qualified personnel are also able to understand and follow the given safety and warning notices.

1.3 Intended use

The product described in this document may be used only for the application specified. The maximum electrical supply data and ambient conditions specified in the technical data section must be adhered. For the perfect and safe operation of the device proper transport and storage as well as professional assembly, installation, handling and maintenance are required.

1.4 Disclaimer of liability

The content of this document has been reviewed to ensure correctness. Nevertheless it may contain errors or inconsistencies and we cannot guarantee completeness and correctness. This is especially true for different language versions of this document. This document is regularly reviewed and updated. Necessary corrections will be included in subsequent version and are available via our webpage www.camillebauer.com.

1.5 Feedback

If you detect errors in this document or if there is necessary information missing, please inform us via e-mail to: customer-support@camillebauer.com

1.6 Repair work and modifications

Repair work and modifications shall exclusively be carried out by the manufacturer. Do not open the housing of the device. In case of any tampering with the device, the warranty claim shall lapse. We reserve the right of changing the product to improve it.

1.7 Calibration and new adjustment

Each device is adjusted and checked before delivery. The condition as supplied to the customer is measured and stored in electronic form. The uncertainty of measurement devices may be altered during normal operation if, for example, the specified ambient conditions are not met.

1.8 Cleaning

The display and the control buttons should be cleaned at regular intervals. Use a dry or slightly damp cloth.



Damage caused by cleaning agents

Detergents can not only affect the clarity of the display, but also cause damage to the device. Therefore, do not use detergents.

1.9 Disposal



Device may only be disposed in a professional manner!

The disposal of devices and components may only be realised in accordance with good professional practice observing the country-specific regulations. Incorrect disposal can cause environmental risks.

1.10 Return

All devices delivered to Camille Bauer Metrawatt AG shall be free of any hazardous contaminants (acids, lyes, solutions, etc.). Use original packaging or suitable transport packaging to return the device.



Damage by returning

Damages caused by improper returning, no warranties or guarantees can be given.

2. Introduction

2.1 Purpose of this document

This document describes the multifunctional measuring device SIRAX MM1400. It is intended to be used by Installers and commissioners, Service and maintenance personnel, as well Planner.

Scope

This handbook is valid for all versions of the SIRAX MM1400. Some of the functions described in this document are available only, if the necessary optional components are included in the device.

Required knowledge

A general knowledge in the field of electrical engineering is required. For assembly and installation of the device knowledge of applicable national safety regulations and installation standard is required.

2.2 Scope of supply

- Measurement device SIRAX MM1400
- Safety instructions (multiple languages)
- Connection set: 4 mounting clamps

2.3 Further documents

Folgende weitere Dokumente zum Gerät sind elektronisch via www.camillebauer.com verfügbar:

- Safety instructions SIRAX MM1400
- Operating Instructions SIRAX MM1400

3. Functional description

The universal measuring device SIRAX MM1400 is suited for fixed mounting and the measurement of Voltage, current, frequency, power, energy (active / reactive / apparent), power factor, phase angle, etc in low voltage switchgear. The units are designed for unbalanced load network forms of 3-phase mains with 3- or 4-wire.



In normal operation the user is presented with one of the measurement reading screens out of several screens. These screens from particular submenu may be scrolled through one at a time in incremental order by touching the “▶” key” and in decremental order by touching “◀” key” on that screen. Viewing of any individual parameter with large reading (eg. shown of Line to neutral Voltage L2 in sub menu 2 screen 13) is also possible by touching that particular parameter.

3.1 Available measurement data

Measured Parameters	Units	3P 3W	3P 4W
System Voltage	V	•	•
Voltage UL1-N / UL2-N / UL3-N	V	–	•
Voltage UL1-2 / UL2-3 / UL3-1	V	•	•
System Current	A	•	•
Current IL1 / IL2 / IL3	A	•	•
Neutral Current	A	–	•
Frequency	Hz	•	•
Active Power	kW	–	•
Reactive Power	kVAr	–	•
Apparent Power	kVA	–	•
Power Factor	–	–	•
Phase Angle	degree	–	•
Active Import Energy (8 Digit resolution)*	kWh	•	•
Active Export Energy (8 Digit resolution)*	kWh	•	•
Reactive Import Energy (8 Digit resolution)*	kVArh	•	•
Reactive Export Energy (8 Digit resolution)*	kVArh	•	•
Apparent Energy (8 Digit resolution)*	kVAh	•	•
Current Demand	A	•	•
Max Current Demand	A	•	•
Apparent Power Demand	kVA	•	•
Max Apparent Power Demand	kVA	•	•
Import Active Power Demand	kW	•	•
Export Active Power Demand	kW	•	•
Max Import Active Power Demand	kW	•	•
Max Export Active Power Demand	kW	•	•
Run Hour	hours	•	•
On Hour	hours	•	•
Number of Interruptions	counts	•	•
Phase Rotation Error	–	–	•
Phase Absent Indication	–	–	•
Voltage THD U1/U2/U3*	%	•	•
Current THD I1/I2/I3*	%	•	•
Min / Max System Voltage	V	–	•
Min / Max System Current	A	–	•
Phase Diagram (only 4 wire)	–	–	•
Voltage Waveform	–	•	•
Current Waveform	–	•	•
Waveform per phase	–	–	•

* THD Parameters are L-N in case of 3P 4W & L-L in case of 3P 3W

3.2 Measurement Parameter Screen

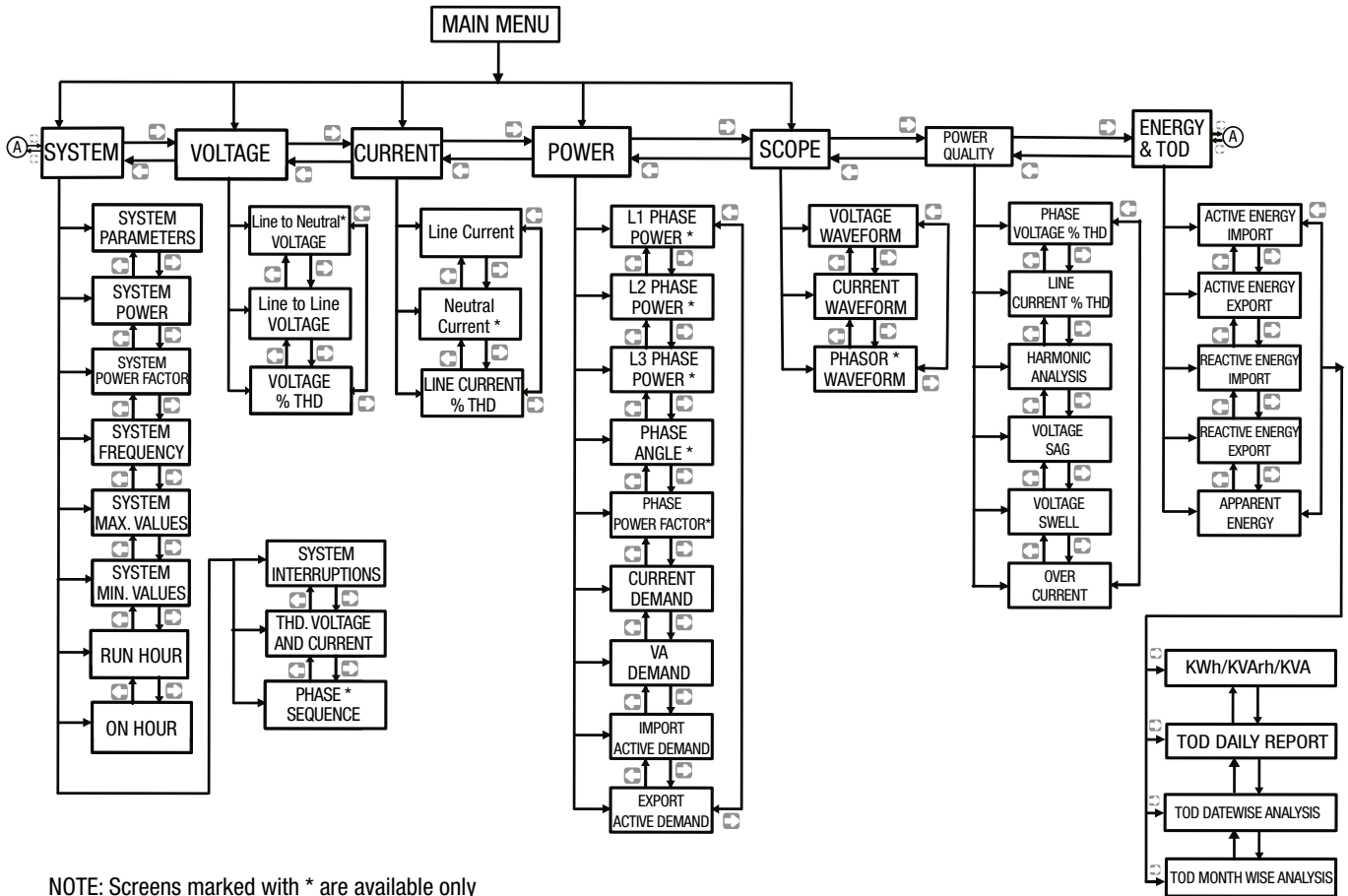

NOTE: Screens marked with * are available only in 4W System (not in 3 wire system)

Harmonic Analyse: When this option is selected from Power Quality menu, meter shows the graphical analysis of the harmonics selected in Setup --> Power Quality Setup --> Harmonic Setup L1/L2/L3. Harmonics are plotted considering fundamental as 100 %. When particular bar is touched, further details of that particular harmonic / fundamental are show. User can view RMS values of voltage and current, voltage & current harmonic distortion %, kW / kVAR / kVA / PF (in 3p 4w only) of that selected harmonic by using side arrow keys.

SAG / Swell / Over Current: These screens show the nos of sag / swell / over current that instrument has detected with the timestamp of arrival of events. Instrument stores the log of up to 30 events on FIFO basis.

Energy and TOD:

Daily report: This screens shows the zone wise energy, its applicable tariff rate & cost of that zone in table format. The total energy accumulated for current day and related cost is also show.

Date wise Analysis: This screen shows the graphical trend of per date energy. Up to last 30 days data is shown. By touching on the bar, energy and cost of that date can be seen.

Month wise Analysis: This screen shows the graphical trend of per month energy. Up to last 12 months data is shown. By touching on the bar in graph, energy and cost of that month can be seen.

3.3 Setup Parameter Screen

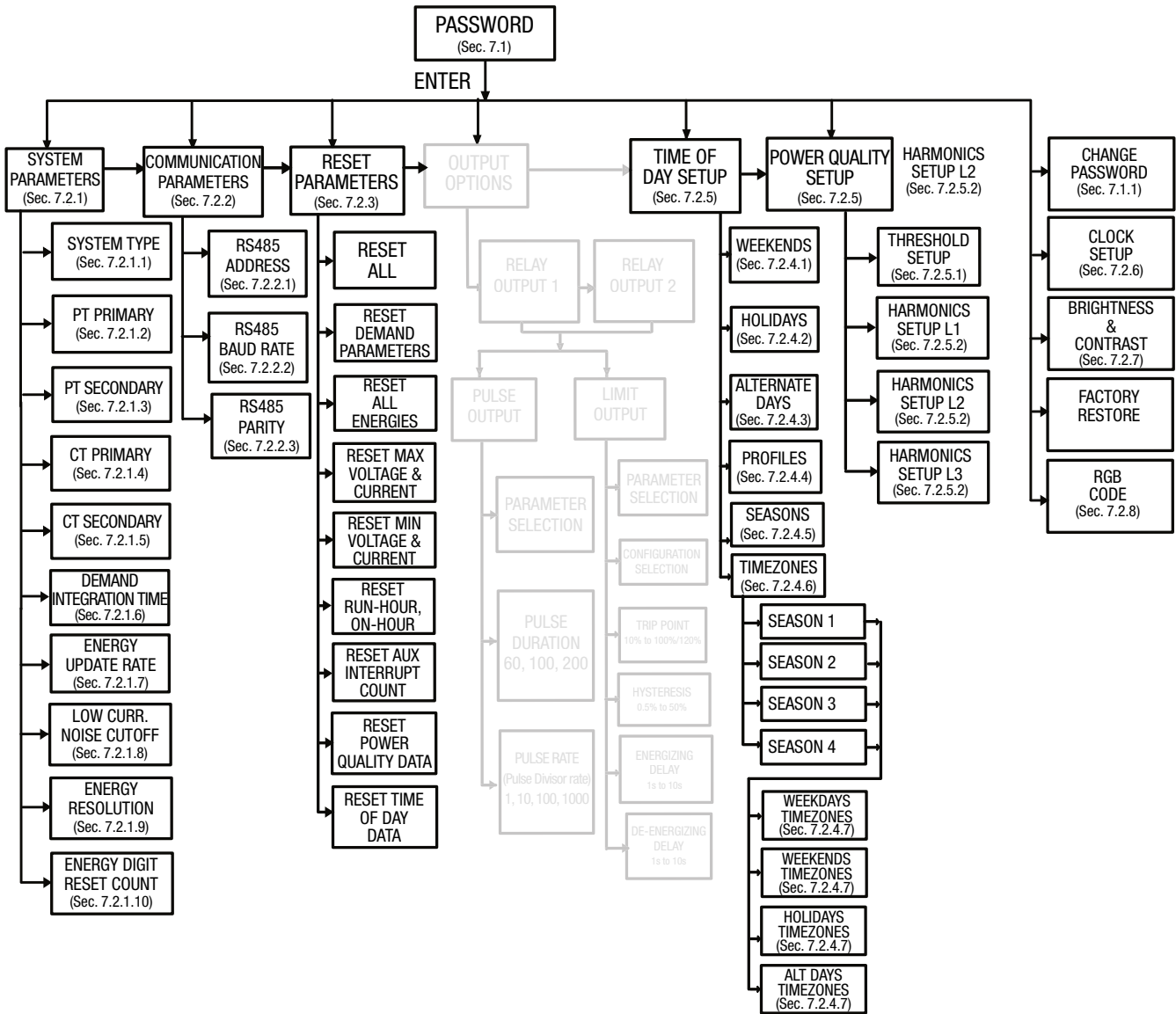

4. Mechanical mounting

The SIRAX MM1400 is designed for panel mounting.



Please ensure that the operating temperature limits are not exceeded when determining the place of mounting (place of measurement): **-10 ... +55° C**

4.1 Panel cut out

Dimensional drawing MM1400: See section 16.1

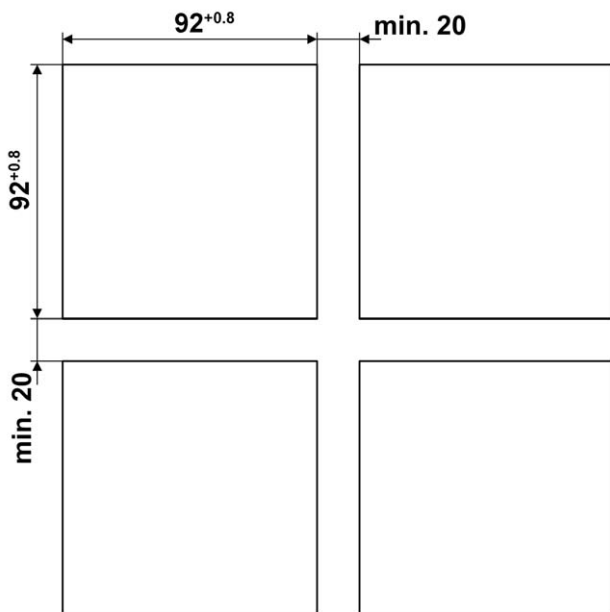

4.2 Mounting of the device

The device is suitable for panel widths up to 5mm and a panel cutout of 96 x 96 mm.

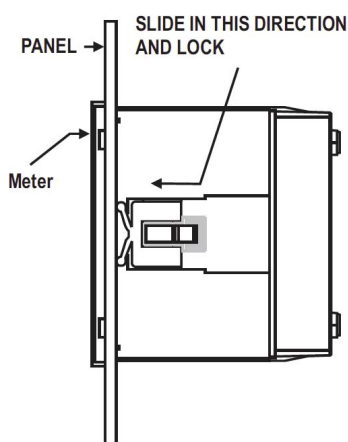

Variant with Mounting clamps

- Slide the device into the cutout from the outside
- Mounting is by four side clamps, slide the side clamps through side slot till side clamp gets firmly locked in a groove (Refer fig.) Consideration should be given to the space required behind the instrument to allow for bends in the connection cables.

4.3 Demounting of the device

The demounting of the device may be performed only if all connected wires are out of service. Remove all plug-in terminals and all connections of the current and voltage inputs. Pay attention to the fact, that current transformers must be shortened before removing the current connections to the device. Then demount the device in the opposite order of mounting (4.2).

5. Electrical connections









Ensure under all circumstances that the leads are free of potential when connecting them!

5.1 General safety notes



Please observe that the data on the type plate must be adhered to!

The national provisions have to be observed in the installation and material selection of electric lines!

Symbol	Meaning
	Device may only be disposed of in a professional manner!
	Double insulation, device of protection class 2
CAT III	Measurement category CAT III for current / voltage inputs, power supply and relay outputs
	CE conformity mark. The device fulfills the requirements of the applicable EC directives. See declaration of conformity.
	Caution! General hazard point. Read the operating instructions.
	Attention: Danger to life!
	Please note

5.2 Possible cross sections and tightening torques

Inputs L1(2), L2(5), L3(8), N(11), I1(1-3), I2(4-6), I3(7-9), power supply (13-14), RS485 connector (A/B/G)

Single wire: 1 x 0,5 ... 4,0mm² oder 2 x 0,5 ... 2,5mm²

Multiwire with end splices: 1 x 0,5 ... 4,0mm² oder 2 x 0,5 ... 2,5mm²

Tightening torque

0,5 ... 0,6 Nm resp. 4,42 ... 5,31 lbf in

5.3 Inputs



All voltage measurement inputs must originate at circuit breakers or fuses rated by 1 Amps. This does not apply to the neutral connector. You have to provide a method for manually removing power from the device, such as a clearly labeled circuit breaker or a fused disconnect switch.

When using **voltage transformers** you have to ensure that their secondary connections never will be short-circuited.



No fuse may be connected upstream of the **current measurement inputs!**

When using **current transformers** their secondary connectors must be short-circuited during installation and before removing the device. Never open the secondary circuit under load.

The connection of the inputs depends on the configured system (connection type).

Three Phase - three wire system, unbalanced load

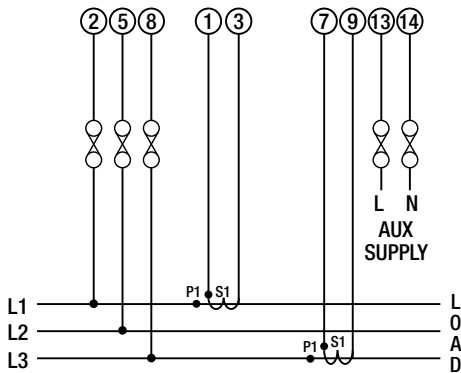

Direct connection

Three Phase - four wire system, unbalanced load

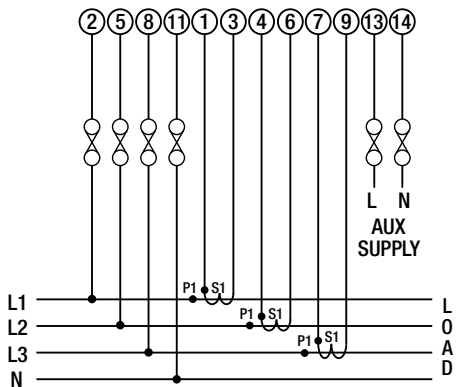

Direct connection

5.4 Power supply



A marked and easily accessible current limiting switch has to be arranged in the vicinity of the device for turning off the power supply. Fusing should be 10 Amps or less and must be rated for the available voltage and fault current.

5.5 Modbus interface RS485

Via the optional Modbus interface measurement data may be provided for a superior system.

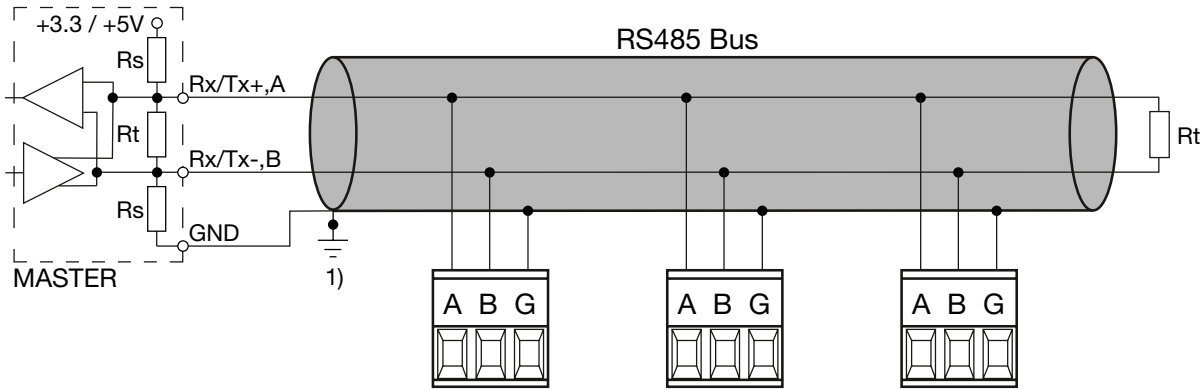

1) One ground connection only. This is possibly made within the master (PC).

Rt: Termination resistors: 120 Ω each for long cables (> approx. 10 m)

Rs: Bus supply resistors, 390 Ω each

The signal wires (A, B) have to be twisted. GND (G) can be connected via a wire or via the cable screen. In disturbed environments shielded cables must be used. Supply resistors (Rs) have to be present in bus master (PC) interface. Stubs should be avoided when connecting the devices. A pure daisy chain network is ideal.

You may connect up to 32 Modbus devices to the bus. A proper operation requires that all devices connected to the bus have equal communication settings (baud rate, transmission format) and unique Modbus addresses.

The bus system is operated half duplex and may be extended to a maximum length of 1200 m without repeater.

6. Commissioning



Before commissioning you have to check if the connection data of the device match the data of the plant. If so, you can start to put the device into operation by switching on the power supply and the measurement inputs.

SIRAX MM1400		
ORDER CODE: 175093		
SR No.: 15/11/0001	IMPULSE: 4000 imp/KWh	
CLASS: 0.5s	CAT III 300V Max.	V1.12
INPUT: 3PH. 500 V L - L, 5A/1A, 45...66Hz		
OPTION: RS485		
AUXILIARY: 60...300V AC/DC, 6.5VA		

Label version standard

7. Programming

The following sections comprise step by step procedures for configuring the instrument for individual user requirements.

To access the set-up screens touch on the "SETUP" icon in Main Menu. This will take the User into the Password Protection Entry Stage (Section 7.1).

7.1. Password Protection

Password protection can be enabled to prevent unauthorised access to set-up screens, by default password is "0000". Password protection is enabled by selecting any four digit number.



After touching "SETUP" icon Password protection screen is displayed. Screen consists of 0 to 9 digit input keypad for entering the password very similar to any calculator in touchscreen mobile. "Enter Password" is displayed on screen at start so that user can enter password using displayed keypad.



Password Incorrect.

If Entered password is wrong then "Password Rejected" is displayed on screen & user need to re-enter the password

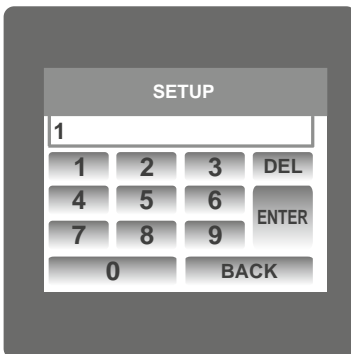

Touching "1" key will display 1 in display area, similarly user can enter remaining 3 digits. For deleting any digit while entering password, user can touch DEL "DEL" key".



After wrong password is entered, user needs to touch "ENTER" key" for trying another password.



After entering the complete password user needs to confirm password by touching "ENTER" key".



Password confirmed.

If Entered password is correct then "Password Accepted" is displayed on screen & user will enter into setup menu.

7.1.1. Change Password



Change Password Option is the second last option in list of "SETUP" submenu, so can be accessed by a simple touch anywhere in "Change Password" row.

In this screen user first needs to enter the current password.



After input of correct password, "PASSWORD ACCEPTED" is displayed & now user can enter the new 4 digit password.



New Password confirmed.

After entering new password user needs to touch "ENTER" key to confirm.

After confirming "PASSWORD CHANGED" is displayed on screen, which ensures successful changing of the password.

7.2. Menu selection

After entering in the SUBMENU 6 - SETUP, user will be asked to enter password & after input of correct password list of following parameters will be displayed on screen.

7.2.1 SYSTEM PARAMETERS

7.2.2 COMMUNICATION PARAMETERS

7.2.3 RESET PARAMETERS

7.2.4 TIME OF DAY SETUP

7.2.5 POWER QUALITY SETUP

7.2.6 CLOCK SETUP

7.2.7 BRIGHTNESS & CONTRAST

Touching on SYSTEM PARAMETER will open the system parameters list screen. Then these screens from particular parameter may be scrolled through one at a time in incremental order by touching the "▶ key" and in decremental order by touching "◀ key" on given touch screen.

7.2.1 System Parameters Selection

After entering in the "SYSTEM PARAMETERS", List of following parameters will be displayed.

7.2.1.1 SYSTEM TYPE

7.2.1.2 PT PRIMARY (L-L)

7.2.1.3 PT SECONDARY (L-L)

7.2.1.4 CT PRIMARY

7.2.1.5 CT SECONDARY

7.2.1.6 DEMAND INTEGRATION TIME

7.2.1.7 ENERGY UPDATE RATE

7.2.1.8 LOW CURRENT NOISE CUTOFF

7.2.1.9 ENERGY RESOLUTION

7.2.1.10 ENERGY DIGIT RESET COUNT

7.2.1.1. System Type

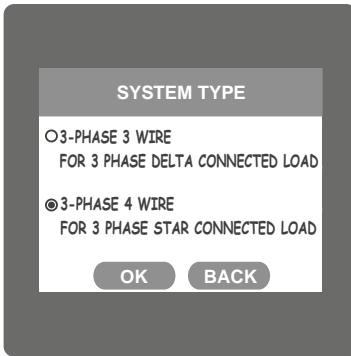

This screen is used to set the system type.

Two types: 3 phase 3 wire & 3 phase 4 wire system are displayed on screen. Touching radio button in front of particular type will select that type.

Touch on “OK” key” will confirm the system type.

Touching the “BACK” key” will keep the old selected setting and will return to previous menu.

Note: If system type is changed, relay parameter selection & analog output selection will be set to NONE.

7.2.1.2. Potential Transformer Primary Value

The nominal full scale voltage will be displayed as Line to Line Voltages for all system types.

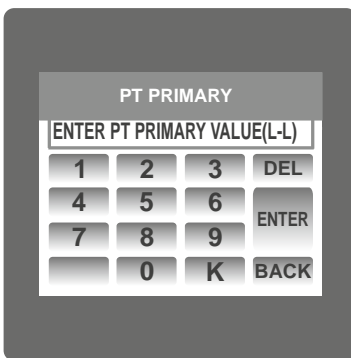

This screen can be accessed only from system parameters list menu. Here again 0 to 9 digit input keypad is provided to set value of PT Primary, & user can confirm this value with a simple touch “ENTER” key”. “K” key” is used to multiply value by 1000.

In case presently displayed Potential Transformer Primary value together with the Current Transformer Primary value, previously set, would result in a maximum power of greater than 666.6 MVA per phase, “Invalid value” will be displayed. Then the valid range will be displayed.

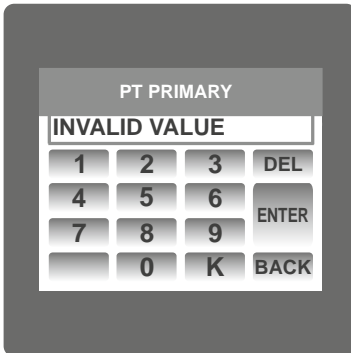

Valid range of PT primary setting value is from **100 VL-L to 692.8 KVL-L.**

If value outside the range is entered, It will display “INVALID VALUE” followed by correct range of parameter.

Note: Setting PT primary value will reset all TOD data & all energies.

While setting PT primary value if auxiliary supply gets off, reset TOD data after auxiliary supply gets on from reset parameter menu. Same is applicable for CT primary value also.

7.2.1.3 Potential Transformer secondary Value

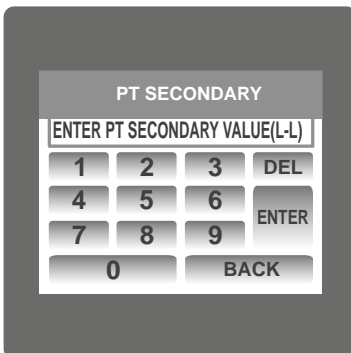

The value must be set to the nominal full scale secondary voltage which will be obtained from the the Transformer when the potential transformer(PT)primary is supplied with the voltage defined in 3.2.1.2 potential transformer primary voltage. The ratio of full scale primary to full scale secondary is defined as the transformer ratio.

This screen can be accessed only from system parameters list menu. Here again 0 to 9 digit input keypad is provided to set value of PT Secondary, & user can confirm this value with a simple touch on “ENTER” key”.

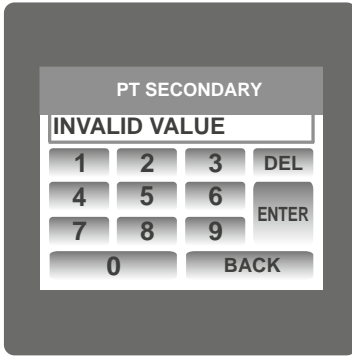

Valid range of PT secondary setting value is from 100.0 to 500.0 VL-L.

If value outside the range is entered, It will display "INVALID VALUE" followed by correct range of parameter.

7.2.1.4 Current Transformer Primary Value

The nominal Full Scale Current that will be displayed as the Line currents. This screen enables the user to display the Line currents inclusive of any transformer ratios, the values displayed represent the Current in Amps.

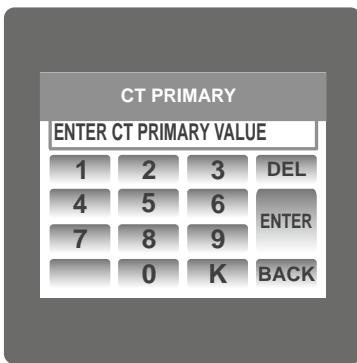

In case presently displayed Current Transformer Primary Value together with the Potential Transformer Primary Value results in a maximum power of greater than 666.6 MVA, "invalid value" will be displayed. Example: If primary value of PT is set as 692.8kV L-L (max value) then primary value of Current is restricted to 1157A.

The "Maximum Power" restriction of 666.6 MVA refers to 120% of nominal current and 120% of nominal voltage, i.e, 462.96 MVA nominal power per phase.

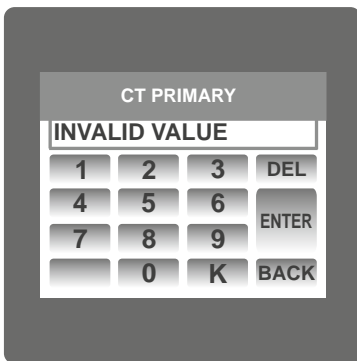

Valid range of CT primary setting value is from 1 to 9999. If value outside the range is entered, It will display "INVALID VALUE" followed by correct range of parameter.

Note: Setting PT primary value will reset all TOD data & all energies.

7.2.1.5 Current Transformer Secondary Value

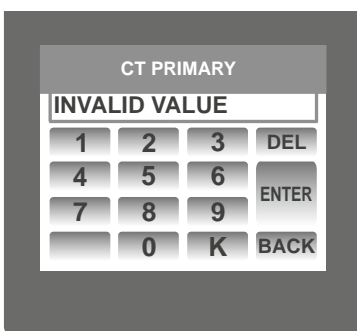

This screen is used to set the secondary value for Current Transformer. Two options: 1 AMPERE & 5 AMPERE are displayed on screen. Touching radio button in front of particular option will select that option. Touch on "OK" key" will confirm the setting. Touching the "BACK" key" will keep the old selected setting and will return to previous menu.

7.2.1.6 Demand Integration Time

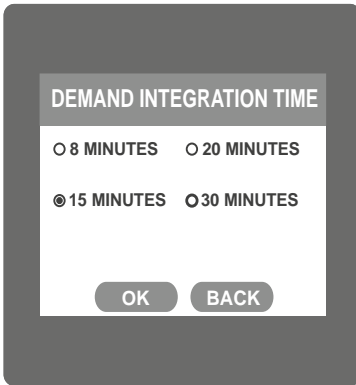

This screen is used to set the period over which current and power readings are to be integrated.

Four options: 8, 15, 20, 30 Minutes are displayed on screen. Touching radio button in front of particular option will select that option.

Touch on "OK" key" will confirm the setting.

Touching the "BACK" key" will keep the old selected setting and will return to previous menu.

7.2.1.7 Energy update rate

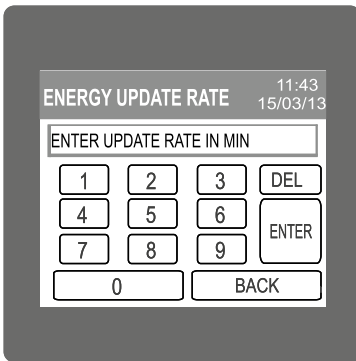

This screen allows user to enter energy update rate in min.

After entering particular value in min. the energy will be updated an modbus location from 30145 to 30153 of 3X register as per value that user has entered.

User can set value from 1 min to 60 min. If user enters value more than 60 min. then "INVALID VALUE" will be displayed and valid band will be shown.

Touching the "BACK" key" will keep the ok! selected setting and will return to previous menu.

For example user has entered 2 min as energy update rate. then after every 2 min, energy counts will be updated on modbus.

7.2.1.8 Low Current noise cutoff.

This screen allows the user to set Low noise current cutoff in mA.

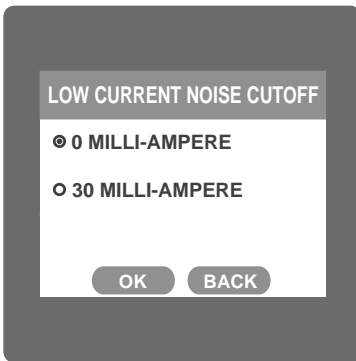

Two options, 0 MILLI-AMPERE & 30 MILLI-AMPERE are displayed on screen. Touching radio button in front of particular option will select that option.

Touch on "OK" key" will confirm the setting.

Touching the "BACK" key" will keep the old selected setting and will return to previous menu.

7.2.1.9 Energy Resolution

This screen enable user to set energy resolution in terms of Wh | kWh | MWh depending as per the user's requirement. This setting is applicable for all types of energy.

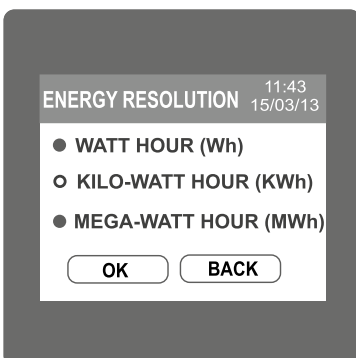

Three options: WATT HOUR, KILO-WATT HOUR & MEGA-WATT HOUR

are displayed on screen. Touching radio button in front of particular option will select that option.

If $(PT \text{ primary} * CT \text{ primary} * \text{Root3}) > 30000 \text{ KW}$ then two options: KILO-WATT HOUR & MEGA-WATT HOUR are displayed on screen.

Note: Default value is sei to 'WATI HOUR' i.e. Energy resolution will be in terms of Wh | VArh | Vah respectively.

7.2.1.10 Energy Digit Reset Count (ROLLOVER COUNT)

This screen enables the user for setting maximum energy count after which energy will rollover to zero. This setting is applicable for all types of energy. Counts outside brackets shows the no. of digits after which energy in 3X register on MODBUS will roll over to zero. The roll over count for overflow count in 3X register on MODBUS is 5 digits. The values inside the brackets show rollover count for energy on display.

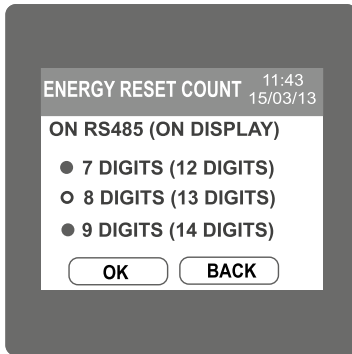

7.2.2 Communication Parameter Selection

After entering in the "COMMUNICATION PARAMETERS" list of following parameters will be displayed

- 3.2.2.1 RS485 ADDRESS
- 3.2.2.2 Rs485 BAUD RATE
- 3.2.2.3 Rs485 PARITY

7.2.2.1 RS485 Address Setting

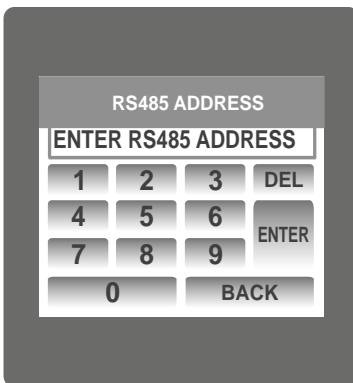

This screen applies to the RS 485 output only. This screen allows the user to set RS485 address parameter for the instrument.

This screen can be accessed only from Communication Parameters List menu.

Here again 0 to 9 digit input keypad is provided to set RS485 address & user can confirm this value with a simple touch on "ENTER" key".

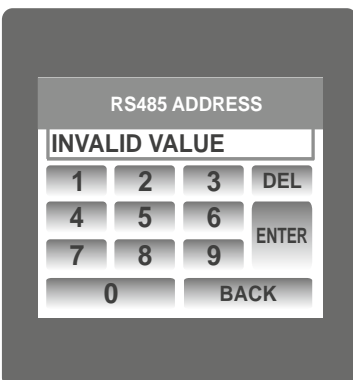

The range of allowable address is 1 to 247.

If value outside the range is entered, it will display "INVALID VALUE" followed by the correct range of parameter.

7.2.2.2 RS 485 Baud Rate

This screen enable user to set energy in terms of Wh / kWh / MWh on Rs485 Output depending as per the user's requirement. This setting is applicable for all types of energy.

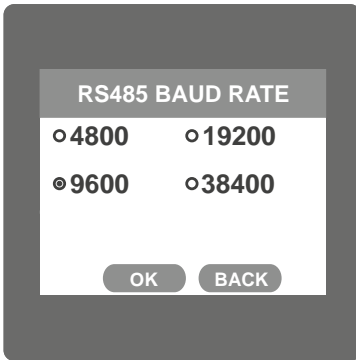

This screen allows the user to set Baud Rate of RS 485 port.

Four options: 4800, 9600, 19200, 38400 Bauds are displayed on screen. Touching radio button in front of particular option will select that option.

Touch on "OK" key" will confirm the setting.

Touching the "BACK" key" will keep the old selected setting and will Return to previous menu.

7.2.2.3 RS 485 Parity & Stop bit Selection

This screen enable user to set energy in terms of Wh / kWh / MWh on Rs485 Output depending as per the user's requirement. This setting is applicable for all types of energy.



This screen allows the user to set Parity & number of stop bits. Four options: ODD PARITY WITH ONE STOP BIT, NO PARITY WITH ONE STOP BIT, NO PARITY WITH TWO STOP BITS, EVEN PARITY WITH ONE STOP BIT are displayed on screen. Touching radio button in front of particular option will select that option.

Touch on "OK" key" will confirm the setting.

Touching the "OK" key" will keep the old selected setting and will return to previous menu.

7.2.3 Reset Parameter Selection

7.2.3.1 Resetting Parameter

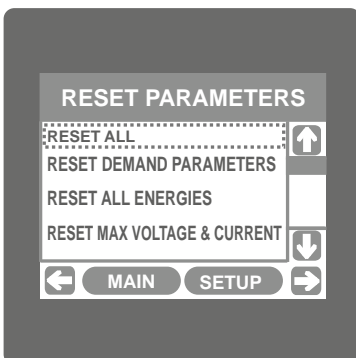

These screens allow the users to reset all the parameters

eg:- Energy, Min, Max, Demand, Run hour, On hour, No. of Interrupts. Power Quality Data, TOD Data.

Touching "down" key scrolls list in upward direction.

For resetting specific parameter user can touch on that parameter.

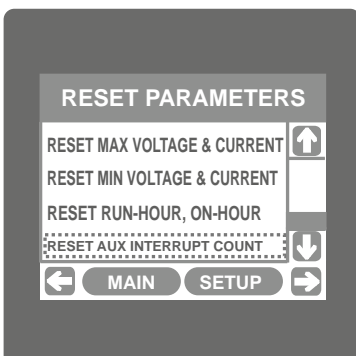

This screen is displayed after repeatedly touching "down" key. Touching "Up" key scrolls list in downward direction.

For resetting specific parameter user can touch on that parameter.

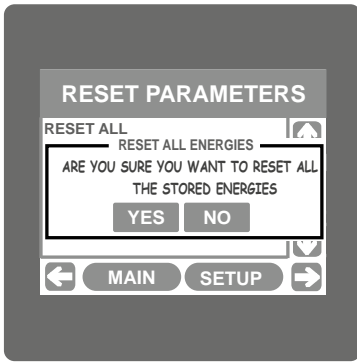

Touching on any parameter will display the confirmation dialog, now a touch on " **YES** key' will confirm the resetting of that particular Parameter.

Touching on " **NO** key' will move back to Reset parameters menu.

For example resetting All Energies will display a confirmation dialog as shown in the screen beside.

User can reset other parameters in similar manner. Resetting Power Quality Data will reset all events in sag, swell and overcurrent log.

While resetting any parameter if auxiliary supply gets off, reset that parameter again after auxiliary supply gets on.

7.2.4 Time Of Day Setup



Time Of Day Setup options allows easy configuration of TOD module Every time when this option is selected it will pop up a message to ask user to verify date & time. It will ask user if he wants to set date & time. When pressed yes user will be directed to clock setup. Pressing no will continue to Time Of Day setup.

Time Of Day:

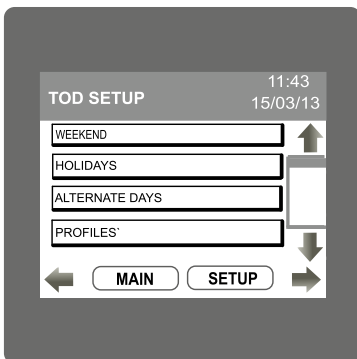

Time-of-day metering is a rate option that is offered by many utilities. When elected by the customer, a meter that records time, and energy usage is installed in place of the existing electrical meter. The metering option benefits utility companies by decreasing the required capacity and customers by providing reduced demand and usage rates during off-peak times, which gives customers a chance to reduce their utility bill. The meter offers a flexible tariff structure. This feature provides a useful way of following different tariff structures during different times of the day for different seasons.

The Time of Use module compares the meter's internal clock with the season, day, and time of day settings in these registers and determines the applicable rate.

Seasons, Profiles, Timezones, Type of day Seasons:

A year can be programmed for a max. of 4 seasons. Each day of a season can be assigned different profiles. Start date of the season is to be entered. This will be active until the next season starts.

Profiles:

Daily profile contains the tariff rates for a particular time zones. A max. of 4 tariff can be programmed.

Time Zones:

A day can be divided into max 6 time zones as per tariff rate. The number and timings of these TOD time Zones are Programmable.

Type of Day: It defines the day types used in the module. Types are weekdays, weekends, holidays, alternate days.

Weekdays:

This register defines the days of the week for all seasons. The rates in the Season (1, 2, 3, 4) Weekday time zone setup registers are used on these days.

Weekends:

This register defines the weekend days for all seasons. The rates in the Season (1,2, 3, 4) Weekend time zone setup registers are used on these days.

Holidays:

Holidays have higher priority than other day types. A max. of 30 holidays can be selected. The rates defined in the Season (1, 2, 3, 4) Holiday Time zone setup registers are used on these days.

Alternate days:

These days generally have different rates from weekdays, weekends, holidays. Alternate days can be assigned a separate profile. A max. of 30 alternate days can be selected.

7.2.4.1 Weekends selection

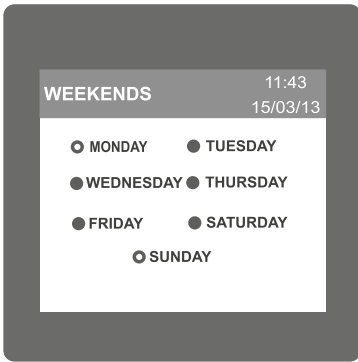

Select weekend by selecting the radio button (dark circle) in front of the day. These days will be considered as weekends for all seasons.

7.2.4.2 Holidays selection

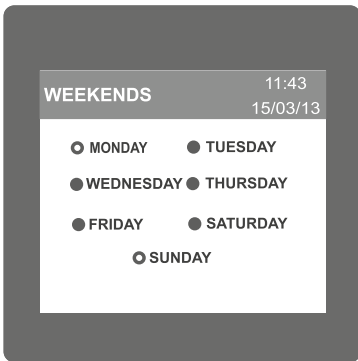

Any day can be assigned as a holiday. Holidays can have separate profile structure than other type of days. Maximum 30 holidays can be selected. To select holiday first activate holiday by touching radio button. Then touch on box to enter date and month.

7.2.4.3 Alternate days selection

Any day can be assigned as a Alternate day. Alternate days can have separate profile structure than other type of days. Maximum 30 Alternate days can be selected.

7.2.4.4 Profiles

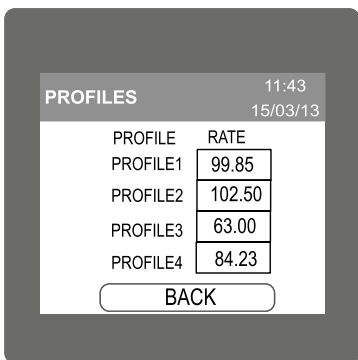

Profile contain a tariff rate that can be assign to particular timezone. Max 4 profile rate can be assign. User can assign profile rate for P1, P2, P3 & P4 between 0.001 to 299.0.

7.2.4.5 Seasons

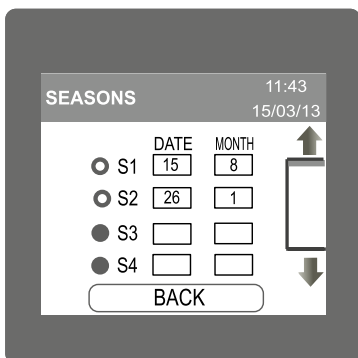

In seasons, user can define maximum 4 season for 12 months. By selecting radio button and entering valid date and month, seasons can be define. All the seasons must be in sequential order. Start date of the season is to be entered. This is will be active until the next season starts. At least 1 season must be selected for proper functioning of TOD module.

7.2.4.6 Timezones



Time zone window shows the seasons which are selected. In time zone user can assign a time zone period at which different tariff profile are applicable.

7.2.4.7 Weekdays / Weekends / Holidays / Alternate days Timezones



User can assign different timezone, tariff profile rate for different day types in each season. User can enter time zones for 4 types of day

- Weekdays
- Weekends
- Holidays
- Alternate days

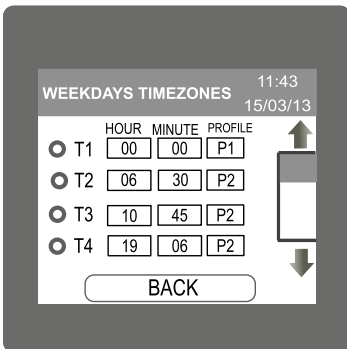

User should ensure that time zones and profile rate are assigned to all selected seasons and day types. The timezones for the day must be in sequential order and must not overlap. Minimum 1 and maximum 6 time zones can be configured. For timezone1 the default time is assigned as 00:00. User has to select a profile rate for it.

Note: When using TOD module it is recommended to set energy resolution in KWh.

7.2.5 Power Quality Setup

7.2.5.1 Threshold Setup

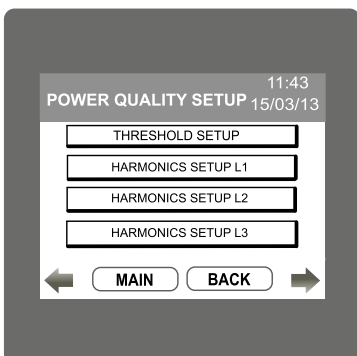

In power quality setup, user can set threshold levels for sag, swell and overcurrent detection. Also user can enter the harmonic no which user want to observe.

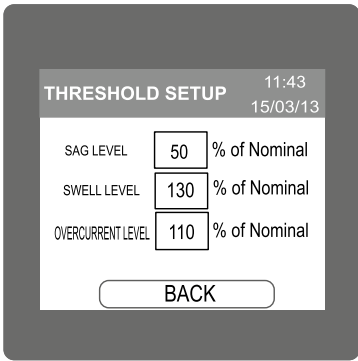

For threshold setup click on threshold setup menu. For sag level, touch the sag level menu and enter the value. The valid threshold level for sag is from 10 % to 90 % of nominal. If user enters wrong value then it will display "INVALID VALUE" and will display the valid range. Similarly threshold value for swell and overcurrent can be configured. The valid range for swell and overcurrent is 110 % to 150 % of nominal value. PT Secondary is considered as nominal value.

7.2.5.2 Harmonics Setup

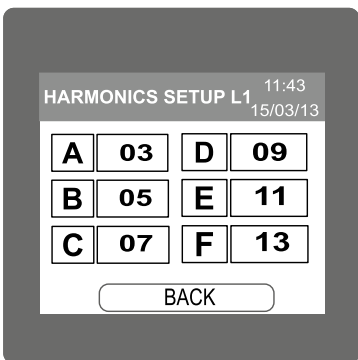

In harmonic setup, user can define the order of harmonics that user want to observe for each phase. Maximum 6 different harmonics number can be configured at a time. For setting of harmonic, touch on the rectangle and enter the number. Valid range for harmonic no is from 2 to 56. Entering wrong value will display "INVALID VALUE" and will show the valid range.

7.2.6 Clock Setup

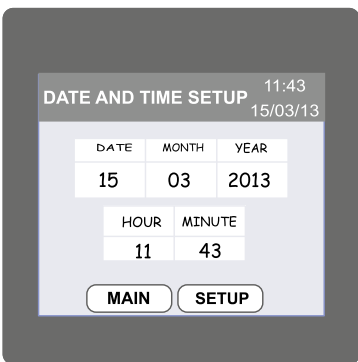

User can set the date and time through this window. By touching the on date, month, year, hour and minute, keypad will pop up and user can enter the date and time through it. Changing hour, date, month, year TOD data will get reset for that period.

7.2.7 Brightness & Contrast



The brightness & contrast of the TFT LCD screen can be varied by the user by sliding the sliders. Touching the "OK" key will OK confirm the current brightness contrast setting. Touching the DEFAULT key will set brightness and contrast as per factory settings. Touching the BACK key will move back to the setup menu without making any changes.

7.2.8 RGB Color Code

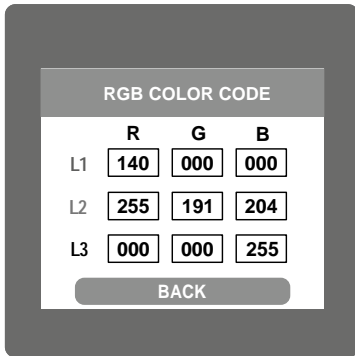

This screen allows user to set the values of Red, Green and Blue components of colors used to display the parameters of all three phases. Different colors can be assigned to each phase using combination of Red, Green and Blue component values. L1, L2 ,L3 will be set to the assigned color.

To set these values, touch the corresponding rectangular section, 0 to 9 digit input keypad will appear. After entering the value using this keypad, user can confirm this value with a simple touch on “ENTER key”.

“BACK key” is used to go back to previous screen.

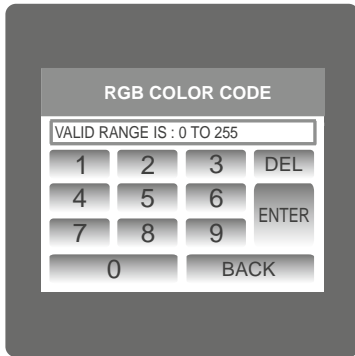

The allowable range for these values is 0 to 255. If a value outside this range is entered, it will display “ VALID RANGE IS : 0 TO 255”.

NOTE: Colors similar to background are not recommended.

Standard color combinations

COLOR	R	G	B
Black	0	0	0
Blue	0	0	255
Brass	181	166	66
Bronze	204	128	51
Brown	166	41	41
Copper	184	115	51
Dark Blue	0	0	140
Dark Brown	102	66	33
Dark Green	0	51	33

COLOR	R	G	B
Dark Pink	232	84	128
Dark Purple	48	26	51
Dark Red	140	0	0
Dark Violet	148	0	212
Dark Yellow	156	135	13
Gold	212	176	56
Gray	128	128	128
Green	0	255	0
Indigo	74	0	130

COLOR	R	G	B
Light Blue	173	217	230
Maroon	176	48	97
Pink	255	191	204
Purple	161	33	240
Red	255	0	0
Silver	191	191	191
Violet	143	0	255
White	255	255	255
Yellow	255	255	0

8. Touch screen calibration

This instrument is able to perform calibration to ensure the proper operation of the units touch screen functionalities. The calibration procedure will correct the problem of out of tolerance touch screen malfunction. Note that errors corrected by this calibration procedure are specific only to touch screen operation.

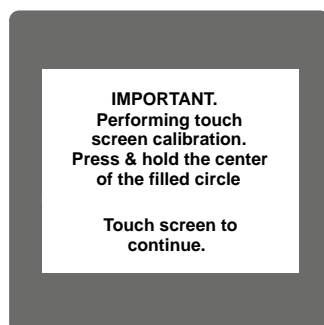

For starting touch screen calibration, touch the screen any where before power up and hold for 1 sec during starting. After that touch screen calibration will start & the message shown besides will be displayed. Touch the screen to continue.

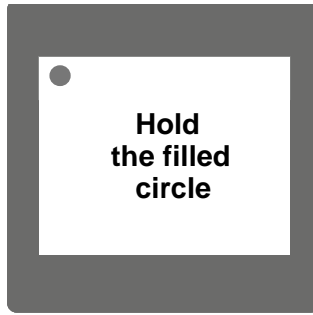
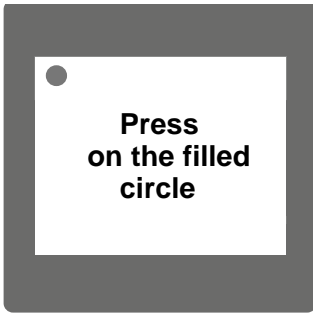

Follow the instructions displayed. Press & hold the center of the filled red circle for at least 2 seconds. Release when message for release is being displayed. For accurate results try to touch the center of the filled circle.

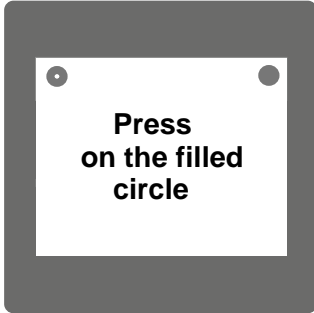

Repeat the same procedure for the remaining 3 corner circles.

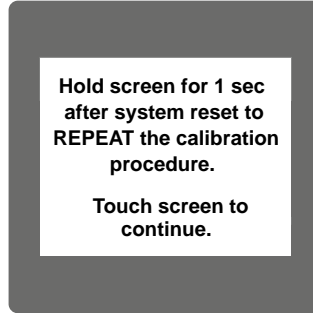

After successful calibration, the message shown besides would be displayed. Touch the screen to continue.



If the touch screen was not calibrated properly, "Error in calibration" message would be shown & the user will be asked to recalibrate the touch screen. In such case the meter will retain the previously stored touch - screen calibration values unless a successful calibration is being performed.

9. Phase Rotation Error screen

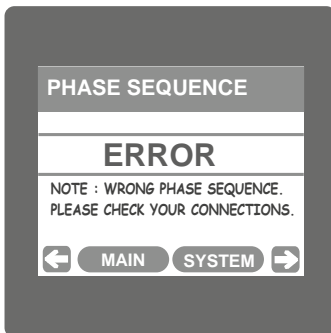

Meter shows phase rotation error if the phase sequence R-Y-B (L1-L2-L3) is not maintained. This screen indicates that Phase sequence is incorrect. User must check this screen in order to get correct readings when meter is connected.

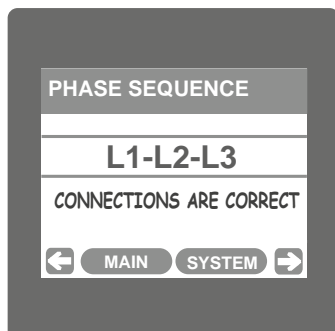

Correct Phase sequence

This screen indicates the phase sequence connected to meter is correct. If phase sequence is wrong, this screen is useful to get correct phase sequence by interchanging connection & verifying it with screen.

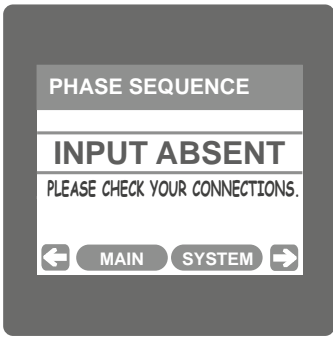

This Screen indicates that either of the phases or all three phases (Voltages) are absent.



10. Run Hour

This Screen shows the total no. of hours the load is connected Even if the Auxiliary supply is interrupted count of Run hour will be maintained in internal memory & displayed in the format "hours. min". For example if Displayed count is 000001.19 hrs it indicates 1 hors & 19 minutes.

After 999999.59 run hours display will restart from zero.

To reset run hour manually see section Resetting Parameter 3.2.3.1

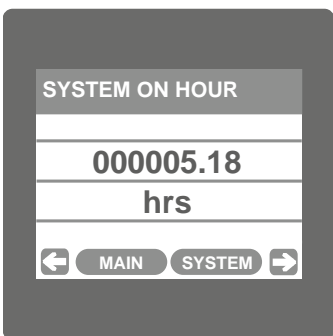

11. On Hour

This Screen shows the total no. of hours the Axillary Supply is ON. Even if the Auxiliary supply is interrupted count of On hour will be maintained in internal memory & displayed in the format "hours. min". For example if Displayed count is 000005.18 hrs it indicates 15 hours & 18 minutes.

After 999999.59 On hours display will restart from zero.

To reset On hour manually see section Resetting Parameter 3.2.3.1

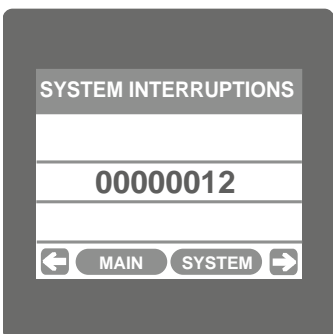

12. Number of Interruption

This Screen Displays the total no. of times the Axillary Supply was Interrupted. Even if the Auxiliary supply is interrupted count will be maintained in internal memory.

To reset No of Interruption manually see section Resetting Parameter 3.2.3.1

13. Phasor Diagram

- Quadrant 1:** 0° to 90°
- Quadrant 2:** 90° to 180°
- Quadrant 3:** 180° to 270°
- Quadrant 4:** 270° to 360°

In this diagram a technical visualization of the current and voltage phasors is shown, using a clockwise rotation.

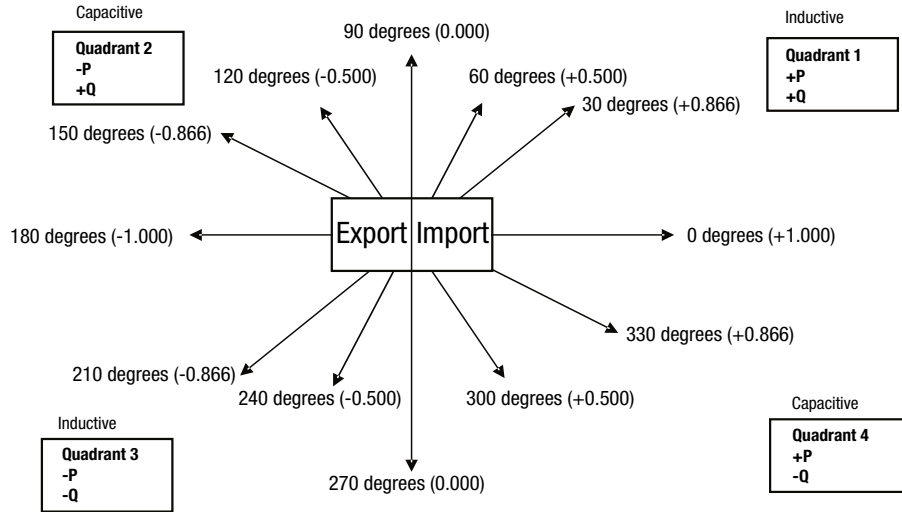

Connections	Quadrant	Sign of Active Power (P)	Sign of Reactive Power (Q)	Sign of Power Factor (PF)	Inductive/ Capacitive
Import	1	+ P	+ Q	+	L
Import	4	+ P	- Q	+	C
Export	2	- P	+ Q	-	C
Export	3	- P	- Q	-	L

Inductive means Current lags Voltage
Capacitive means Current leads Voltage

When the instrument displays Active power (P) with “ + ” (positive sign) , the connection is “ **Import** ” .
 When the instrument displays Active power (P) with “ - ” (negative sign) , the connection is “ **Export** ” .

14. Technical data

System

Connection types:	3 Phase 3 Wire / 4 Wire programmable at site
Nominal frequency:	45 ... 50/60 ... 66 Hz
Measurement TRMS:	Up to the 15th harmonic

Inputs

Nominal input voltage	$57.73 V_{L-N} \dots 288.675 V_{L-N} (100 V_{L-L} \dots 500 V_{L-L})$
Max continuous input voltage	$347 V_{L-N} (600 V_{L-L})$
Max short duration input voltage	2 x Rated Value (1s application repeated 10 times at 10s intervals)
Nominal input voltage burden	0.2VA approx. per phase
Nominal input current	5A AC rms
Max continuous input current	120% of Rated Value
Nominal input current burden	0.2VA approx. per phase
Max short duration current input	20 x Rated Value (1s application repeated 5 times at 5 min. intervals)
System CT primary values	Std. Values from 1 to 9999A (1 or 5 Amp secondaries)

Auxiliary

Standard nominal Auxillary	60 - 300V AC- DC
a.c. supply voltage tolerance	+5 % / -5 % of Rated Value
d.c. supply voltage tolerance	+10 % / -10 % of Rated Value
a.c. supply burden	6.5VA
d.c. supply burden	3W

Operating Measuring Ranges

Voltage	5 .. 120 % of Rated Value
Current	5 .. 120 % of Rated Value
Power Factor	0.5 Lag ... 1 ... 0.8 Lead

Accuracy

Voltage / Current	± 0.2 % of range
Frequency	0.1% of mid frequency
Active / Re-Active Power	± 0.2 % of range
Apparent Power	± 0.2 % of range
Active / Apparant Energy	Class 0.5S acc. to IEC 62053-22
Re-Active Energy	Class 2 acc. to IEC 62053-23
Power Factor	± 2 degree
Angle	± 2 degree
Total Harmonic Distortion	± 1 %
Neutral Current	± 4 % of range

Reference conditions for Accuracy

Reference temperature	23 C + 2 C
Input frequency	50 or 60Hz + 2%
Input waveform	Sinusoidal (distortion factor 0.005)
Current Range	5 ... 100% of Nominal Value.
Starting current for energy as per IEC 62053-22 0.5S	1mA for 1A range 5mA for 5A range

Mechanical attributes

Orientation	Any
Dimensions	see dimensional drawing
Bezel size	96 mm x 96 mm (DIN 43718)
Panel cut out	92+0.8mm x 92+0.8mm detail see cut out drawing
Overall depth	80 mm
Material	PC 10% unfilled
TFT LCD	3.5" Graphical LCD, resolution 320x240 pixels
Update	Approx. 1 seconds
User Interface	Resistive Touch screen
Terminals	Screw-type terminals
Weight	0.620 kg Approx.

Environmental conditions

Operating temperature	-10 to 55 °C
Storage temperature	-20 to +65 °C
Relative humidity	0 .. 90 % RH
Warm up time	3 minute (minimum)
Real time Clock (RTC) / uncertainty	+/- 2 minutes / months (23°C +/- 1°C) (trimmable through display or Modbus)
Shock	150 m/s ² (15g) in 3 planes
Vibration	10 .. 150 ... 10 Hz, 0.75mm amplitude
Temperature Coefficient	0.05% / °C
Enclosure (IP for water & dust)	IP 54 (front), IP 20 (housing/terminals) acc. to IEC 60529

Standards

EMC Emmision	IEC 61326-1: 2005
EMC Immunity	10V/m min (IEC 61000-4-3)
Safety	IEC 61010-1: 2001
Protection class	II
Pollution degree	2
Installation category	CATIII
High voltage test	5.23 kV RMS 50 Hz for 1 minute between all electrical circuits

ModBus (RS 485) Option

Protocol	ModBus (RS 485)
Baud Rate	19200 , 9600 , 4800 or 2400 (Programmable)
Parity	Odd or Even, with 1 stop bit, Or None with 1 or 2 stop bits

ModBus TCP (Ethernet, RJ45) Option:

Protokoll:	Modbus TCP
Mode:	10/100 MBit/s
Factory setting IP adress:	192.168.11.11

Impulse Output

Impulse Constand	4000 impulses / kWh
------------------	---------------------

14.1 Dimensional drawings

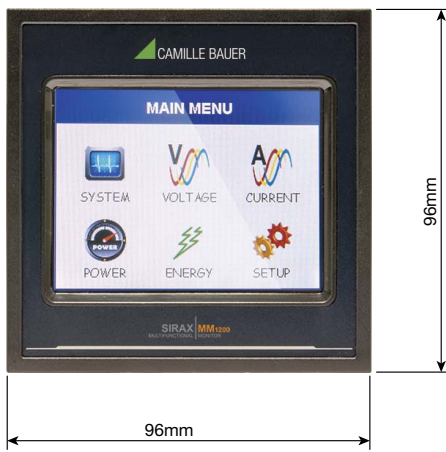

14.2 Connection and programming via RS485 (Modbus RTU) interface

Follow the subsequent steps to program the transducer via the RS485 interface and Modbus:

Step 1: Connection

Connect the Modbus cable according to the connection diagram in Chapter 5.3. Please observe also the information in the Modbus (RS485) interface definition.

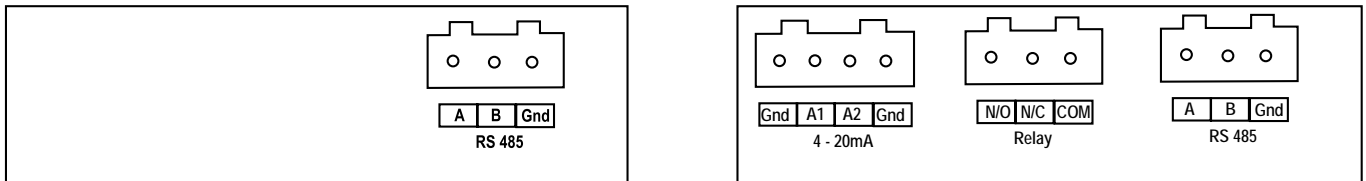

Step 2: Programming

Program SIRAX MM1400 via the Modbus RTU interface and the CB-Configurator software. Please observe the detailed Modbus description in Chapter 16. After every programming section you have to reboot the device. After completing the programming, the device must be rebooted. Connect the power supply to SIRAX MM1400 before programming.

14.3 Connection and programming via Ethernet RJ45 (Modbus TCP) interface

If you program the transmitter via the Ethernet RJ45 interface and Modbus, the following steps must be followed:

Step 1: Connection

Connect the Ethernet cable to the RJ45 interface on the device.

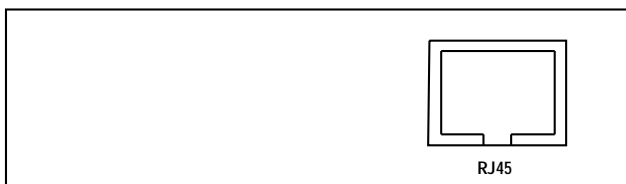

Step 2: Programming

The SIRAX MM1400 is programmed via the Modbus TCP interface and the CB Configurator software. The device is delivered with a factory-pre-set IP address of "192.168.11.11". This can be changed in the CB-Configurator software (see CB-Configurator Software manual). Please note that the device must be rebooted after adapting the new IP address. The detailed Modbus descriptions can be found in chapter 18. The power supply must be connected to the SIRAX MM1400 before it can be programmed.

15. Interface Definition Modbus (RS485)

THE MULTIFUNCTION ENERGY METER supports MODBUS (RS485) RTU protocol (2-wire).

Connection should be made using twisted pair shielded cable. All "A" and "B" connections are daisy chained together. The screens should also be connected to the "Gnd" terminal. To avoid the possibility of loop currents, an Earth connection should be made at one point on the network. Loop (ring) topology does not require any termination load. Line topology may or may not require terminating loads depending on the type and length of cable used. The impedance of the termination load should match the impedance of the cable and be at bothends of the line. The cable should be terminated at each end with a 120 ohm (1/4 Watt min.) resistor.

RS 485 network supports maximum length of 1.2km. Including the Master, a maximum of 32 instruments can be connected in RS485 network. The permissible address range for the Meter is between 1 and 247 for 32 instruments. Broadcast Mode (address 0) is not allowed.

The maximum latency time of an Meter is 50ms i.e. this is the amount of time that can pass before the first response character is output.

After sending any query through software (of the Master), it must allow 50ms of time to elapse before assuming that the Meter is not going to respond. If slave does not respond within 50 ms, Master can ignore the previous query and can issue fresh query to the slave.

The each byte in RTU mode has following format:

	8-bit binary, hexadecimal 0-9, A-F 2 hexadecimal characters contained in each 8-bit field of the message
Format of Data Bytes	4 bytes (32 bits) per parameter. Floating point format (to IEEE 754) Most significant byte first (Alternative least significant byte first)
Error Checking Bytes	2 byte Cyclical Redundancy Check (CRC)
Byte format	1 start bit, 8 data bits, least significant bit sent first 1 bit for even/odd parity 1 stop bit if parity is used; 1 or 2 bits if no parity

Communication Baud Rate is user selectable from the front panel between 4800, 9600, 19200, 38400 bps.

Function code:

03	Read Holding Registers	Read content of read /write location (4X)
04	Read input Registers	Read content of read only location (3X)
16	Presets Multiple Registers	Set the content of read / write locations (4X)

Exception Cases: An exception code will be generated when Meter receives ModBus query with valid parity and error check but which contains some other error (e.g. Attempt to set floating point variable to an invalid value). The response generated will be “Function code” ORed with HEX (80H). The exception codes are listed below.

01	Illegal function	The function code is not supported by Meter
02	Illegal Data Address	Attempt to access an invalid address or an attempt to read or write part of a floating point value
03	Illegal DataValue	Attempt to set a floating point variable to an invalid value
04	Slave Device Failure	An error occurred so that slave device has failed to communicate.
06	Slave Device Busy	The slave is engaged in processing a long-duration program command. The master should retransmit the message when the slave is free.

15.1 Accessing 3 X register for reading measured values

Two consecutive 16 bit registers represent one parameter. Refer **TABLE 1: 3 X register addresses** (Parameters measured by the instruments). Each parameter is held in the 3X registers. Modbus Code 04 is used to access all parameters.

Example :

To read parameter,
Volts 3: Start address = 04 (Hex) Number of registers = 02

Note: Number of registers = Number of parameters x 2

Each Query for reading the data must be restricted to 20 parameters or less. Exceeding the 20 parameter limit will cause a ModBus exception code to be returned.

Query :

01 (Hex)	04 (Hex)	00 (Hex)	04 (Hex)	00 (Hex)	02 (Hex)	30 (Hex)	0A (Hex)
Device Address	Function Code	Start Adress High	Start Adress Low	Number of Registers Hi	Number of Registers Low	CRC Low	CRC High

Start Address High: Most significant 8 bits of starting address of the parameter requested.

Start Address low: Least significant 8 bits of starting address of the parameter requested.

Number of register Hi: Most significant 8 bits of Number of registers requested.

Number of register Lo: Least significant 8 bits of Number of registers requested.

(Note: Two consecutive 16 bit register represent one parameter.)

Response: Volt3 (219.25V)

01 (Hex)	04 (Hex)	04 (Hex)	43 (Hex)	5B (Hex)	41 (Hex)	21 (Hex)	6F (Hex)	9B (HEX)
Device Address	Function Code	Byte Count	Data Register1 High Byte	Data Register1 Low Byte	Data Register2 High Byte	Data Register2 Low Byte	CRC Low	CRC High

Byte Count: Total number of data bytes received.

Data register 1 High Byte: Most significant 8 bits of Data register 1 of the parameter requested.

Data register 1 Low Byte: Least significant 8 bits of Data register 1 of the parameter requested.

Data register 2 High Byte: Most significant 8 bits of Data register 2 of the parameter requested.

Data register 2 Low Byte: Least significant 8 bits of Data register 2 of the parameter requested.

(Note: Two consecutive 16 bit register represent one parameter.)

TABLE 1: 3 X register addresses (measured parameters)

Adress (Register)	Parameter No.	Parameter	Modbus Start	Adress Hex	3P 4W	3P 3W
			High Byte	Low Byte		
30001	1	Volts 1	00	0	•	•
30003	2	Volts 2	00	2	•	•
30005	3	Volts 3	00	4	•	•
30007	4	Current 1	00	6	•	•
30009	5	Current 2	00	8	•	•
30011	6	Current 3	00	A	•	•
30013	7	W1	00	C	•	x
30015	8	W2	00	E	•	x
30017	9	W3	00	10	•	x
30019	10	VA 1	00	12	•	x
30021	11	VA 2	00	14	•	x
30023	12	VA 3	00	16	•	x
30025	13	VAR 1	00	18	•	x
30027	14	VAR 2	00	1A	•	x
30029	15	VAR 3	00	1C	•	x
30031	16	PF 1	00	1E	•	x
30033	17	PF 2	00	20	•	x
30035	18	PF 3	00	22	•	x
30037	19	Phase Angle 1	00	24	•	x
30039	20	Phase Angle 2	00	26	•	x
30041	21	Phase Angle 3	00	28	•	x
30043	22	Volts Avg	00	2A	•	•
30045	23	Volts Sum	00	2C	•	•
30047	24	Current Avg	00	2E	•	•
30049	25	Current Sum	00	30	•	•
30051	26	Watt Avg	00	32	•	•
30053	27	Watt Sum	00	34	•	•
30055	28	VA Avg	00	36	•	•
30057	29	VA Sum	00	38	•	•
30059	30	VAR Avg	00	3A	•	•
30061	31	VAR Sum	00	3C	•	•
30063	32	PF Avg	00	3E	•	•
30065	33	PF Sum	00	40	•	x
30067	34	Phase Angle Avg	00	42	•	•
30069	35	Phase Angle Sum	00	44	•	x
30071	36	Freq	00	46	•	•

30073	37	Wh Import / Utility	00	48	•	•
30075	38	Wh Export / Gen	00	4A	•	•
30077	39	Capacitive / Utility VARh	00	4C	•	•
30079	40	Inductive / Gen VARh	00	4E	•	•
30081	41	VAh / Vah Utility	00	50	•	•
30083	42	-	-	-	-	-
30085	43	W Demand (Import)	00	54	•	•
30087	44	W Max Demand (Import)	00	56	•	•
30089	45	W Demand (Export)	00	58	•	•
30091	46	W Max Demand (Export)	00	5A	•	•
30101	51	VA Demand	00	64	•	•
30103	52	V A Max Demand	00	66	•	•
30105	53	A Demand	00	68	•	•
30107	54	A Max Demand	00	6A	•	•
30109	55	Wh Import (no of overflows in register 30073 / 30111)	00	6C	•	•
30111	56	Wh Import	00	6E	•	•
30113	57	Wh Export (no of overflows in register 30075 / 30115)	00	70	•	•
30115	58	Wh export	00	72	•	•
30117	59	VARh Import (no of overflows in register 30077 / 30119)	00	74	•	•
30119	60	VARh import	00	76	•	•
30121	61	VARh Export (no of overflows in register 30079 / 30123)	00	78	•	•
30123	62	VARh export	00	7A	•	•
30125	63	VAh (no of overflows in register 30081 / 30127)	00	7C	•	•
30127	64	Vah	00	7E	•	•
30133	67	System Max Voltage	00	84	•	•
30135	68	System Min Voltage	00	86	•	•
30141	71	System Max Current	00	8C	•	•
30143	72	System Min Current	00	8E	•	•
30145	73	Wh import depending on update rate	00	90	•	•
30147	74	Wh export depending on update rate	00	92	•	•
30149	75	VARh import depending on uodate rate	00	94	•	•
30151	76	VARh export depending on uodate rate	00	96	•	•
30153	77	VAh depending on update rate	00	98	•	•
30163	82	Running Season no	00	A2	•	•
30165	83	Running Day type	00	A4	•	•
30167	84	Running Zone no.	00	A6	•	•
30169	85	Running tariff rate	00	A8	•	•
30171	86	RTC Minute	00	AA	•	•
30173	87	RTC Hour	00	AC	•	•
30175	88	RTC Date	00	AE	•	•
30177	89	RTC Month	00	B0	•	•
30179	90	RTC Year	00	B2	•	•
30181	91	Running zone Active Import Energy	00	B4	•	•
30183	92	Running zone Active Import Cost	00	B6	•	•
30185	93	Running zone Active Export Energy	00	B8	•	•

30187	94	Running zone Active Export Cost	00	BA	•	•
30189	95	Running zone Reactive Import Energy	00	BC	•	•
30191	96	Running zone Reactive Import Cost	00	BE	•	•
30193	97	Running zone Reactive Export Energy	00	C0	•	•
30195	98	Running zone Reactive Export Cost	00	C2	•	•
30197	99	Running zone Apparent Energy	00	C4	•	•
30199	100	Running zone Apparent Cost	00	C6	•	•
30201	101	VL 1 - 2 (Calculated)	00	C8	•	x
30203	102	VL 2 - 3 (Calculated)	00	CA	•	x
30205	103	VL 3- 1 (Calculated)	00	CC	•	x
30207	104	V1 THD (%)	00	CE	•	•
30209	105	V2 THD (%)	00	D0	•	•
30211	106	V3 THD (%)	00	D2	•	•
30213	107	I1 THD (%)	00	D4	•	•
30215	108	I2 THD (%)	00	D6	•	•
30217	109	I3 THD (%)	00	D8	•	•
30219	110	System Voltage THD (%)	00	DA	•	•
30221	111	System Current THD (%)	00	DC	•	•
30225	113	I Neutral	00	E0	•	x
30227	114	Run Hour	00	E2	•	•
30229	115	On Hour	00	E4	•	•
30231	116	No. of interrupts	00	E6	•	•
30233	117	VRMS Fundamental L 1	00	E8	•	•
30235	118	IRMS Fundamental L 1	00	EA	•	•
30237	119	Watt Fundamental L 1	00	EC	•	x
30239	120	VAR Fundamental L 1	00	EE	•	x
30241	121	VA Fundamental L 1	00	F0	•	x
30243	122	PF Fundamental L 1	00	F2	•	x
30245	123	VTHD L1 (%)	00	F4	•	•
30247	124	ITHD L1 (%)	00	F6	•	•
30249	125	VRMS Harmonic A L1	00	F8	•	•
30251	126	IRMS Harmonic A L1	00	FA	•	•
30253	127	Watt Harmonic A L1	00	FC	•	x
30255	128	VAR Harmonic A L1	00	FE	•	x
30257	129	VA Harmonic A L1	01	0	•	x
30259	130	PF Harmonic A L1	01	2	•	x
30261	131	Voltage HD Harmonic A L1	01	4	•	•
30263	132	Current HD Harmonic A L1	01	6	•	•
30265	133	VRMS Harmonic B L1	01	8	•	•
30267	134	IRMS Harmonic B L1	01	A	•	•
30269	135	Watt Harmonic B L1	01	C	•	x
30271	136	VAR Harmonic B L1	01	E	•	x
30273	137	VA Harmonic B L1	01	10	•	x
30275	138	PF Harmonic B L1	01	12	•	x
30277	139	Voltage HD Harmonic B L1	01	14	•	•
30279	140	Current HD Harmonic B L1	01	16	•	•
30281	141	VRMS Harmonic C L1	01	18	•	•
30283	142	IRMS Harmonic C L1	01	1A	•	•

30285	143	Watt Harmonic C L1	01	1C	•	x
30287	144	VAR Harmonic C L1	01	1E	•	x
30289	145	VA Harmonic C L1	01	20	•	x
30291	146	PF Harmonic C L1	01	22	•	x
30293	147	Voltage HD Harmonic C L1	01	24	•	•
30295	148	Current HD Harmonic C L1	01	26	•	•
30297	149	VRMS Harmonic D L1	01	28	•	•
30299	150	IRMS Harmonic D L1	01	2A	•	•
30301	151	Watt Harmonic D L1	01	2C	•	x
30303	152	VAR Harmonic D L1	01	2E	•	x
30305	153	VA Harmonic D L1	01	30	•	x
30307	154	PF Harmonic D L1	01	32	•	x
30309	155	Voltage HD Harmonic D L1	01	34	•	•
30311	156	Current HD Harmonic D L1	01	36	•	•
30313	157	VRMS Harmonic E L1	01	38	•	•
30315	158	IRMS Harmonic E L1	01	3A	•	•
30317	159	Watt Harmonic E L1	01	3C	•	x
30319	160	VAR Harmonic E L1	01	3E	•	x
30321	161	VA Harmonic E L1	01	40	•	x
30323	162	PF Harmonic E L1	01	42	•	x
30325	163	Voltage HD Harmonic E L1	01	44	•	•
30327	164	Current HD Harmonic E L1	01	46	•	•
30329	165	VRMS Harmonic F L1	01	48	•	•
30331	166	IRMS Harmonic F L1	01	4A	•	•
30333	167	WATT Harmonic F L1	01	4C	•	x
30335	168	VAR Harmonic F L1	01	4E	•	x
30337	169	VA Harmonic F L1	01	50	•	x
30339	170	PF Harmonic F L1	01	52	•	x
30341	171	Voltage HD Harmonic F L1	01	54	•	•
30343	172	Current HD Harmonic F L1	01	56	•	•
30345	173	VRMS Fundamental L2	01	58	•	•
30347	174	IRMS Fundamental L2	01	5A	•	x
30349	175	WATT Fundamental L2	01	5C	•	x
30351	176	VAR Fundamental L2	01	5E	•	x
30353	177	VA Fundamental L2	01	60	•	x
30355	178	PF Fundamental L2	01	62	•	x
30357	179	VTHD L2 (%)	01	64	•	•
30359	180	ITHD L2 (%)	01	66	•	x
30361	181	VRMS Harmonic A L2	01	68	•	•
30363	182	IRMS Harmonic A L2	01	6A	•	x
30365	183	WATT Harmonic A L2	01	6C	•	x
30367	184	VAR Harmonic A L2	01	6E	•	x
30369	185	VA Harmonic A L2	01	70	•	x
30371	186	PF Harmonic A L2	01	72	•	x
30373	187	Voltage HD Harmonic A L2	01	74	•	•
30375	188	Current HD Harmonic A L2	01	76	•	x
30377	189	VRMS Harmonic B L2	01	78	•	•
30379	190	IRMS Harmonic B L2	01	7A	•	x

30381	191	WATT Harmonic B L2	01	7C	•	x
30383	192	VAR Harmonic B L2	01	7E	•	x
30385	193	VA Harmonic B L2	01	80	•	x
30387	194	PF Harmonic B L2	01	82	•	x
30389	195	Voltage HD Harmonic B L2	01	84	•	•
30391	196	Current HD Harmonic B L2	01	86	•	x
30393	197	VRMS Harmonic C L2	01	88	•	•
30395	198	IRMS Harmonic C L2	01	8A	•	x
30397	199	WATT Harmonic C L2	01	8C	•	x
30399	200	VAR Harmonic C L2	01	8E	•	x
30401	201	VA Harmonic C L2	01	90	•	x
30403	202	PF Harmonic C L2	01	92	•	x
30405	203	Voltage HD Harmonic C L2	01	94	•	•
30407	204	Current HD Harmonic C L2	01	96	•	x
30409	205	VRMS Harmonic D L2	01	98	•	•
30411	206	IRMS Harmonic D L2	01	9A	•	x
30413	207	WATT Harmonic D L2	01	9C	•	x
30415	208	VAR Harmonic D L2	01	9E	•	x
30417	209	VA Harmonic D L2	01	A0	•	x
30419	210	PF Harmonic D L2	01	A2	•	x
30421	211	Voltage HD Harmonic D L2	01	A4	•	•
30423	212	Current HD Harmonic D L2	01	A6	•	x
30425	213	VRMS Harmonic E L2	01	A8	•	•
30427	214	IRMS Harmonic E L2	01	AA	•	x
30429	215	WATT Harmonic E L2	01	AC	•	x
30431	216	VAR Harmonic E L2	01	AE	•	x
30433	217	VA Harmonic E L2	01	B0	•	x
30435	218	PF Harmonic E L2	01	B2	•	x
30437	219	Voltage HD Harmonic E L2	01	B4	•	•
30439	220	Current HD Harmonic E L2	01	B6	•	x
30441	221	VRMS Harmonic F L2	01	B8	•	•
30443	222	IRMS Harmonic F L2	01	BA	•	x
30445	223	WATT Harmonic F L2	01	BC	•	x
30447	224	VAR Harmonic F L2	01	BE	•	x
30449	225	VA Harmonic F L2	01	C0	•	x
30451	226	PF Harmonic F L2	01	C2	•	x
30453	227	Voltage HD Harmonic F L2	01	C4	•	•
30455	228	Current HD Harmonic F L2	01	C6	•	x
30457	229	VRMS Fundamental L3	01	C8	•	•
30459	230	IRMS Fundamental L3	01	CA	•	•
30461	231	WATT Fundamental L3	01	CC	•	x
30463	232	VAR Fundamental L3	01	CE	•	x
30465	233	VA Fundamental L3	01	D0	•	x
30467	234	PF Fundamental L3	01	D2	•	x
30469	235	VTHD L3 (%)	01	D4	•	•
30471	236	ITHD L3 (%)	01	D6	•	•
30473	237	VRMS Harmonic A L3	01	D8	•	•
30475	238	IRMS Harmonic A L3	01	DA	•	•
30477	239	WATT Harmonic A L3	01	DC	•	x

30479	240	VAR Harmonic A L3	01	DE	•	x
30481	241	VA Harmonic A L3	01	E0	•	x
30483	242	PF Harmonic A L3	01	E2	•	x
30485	243	Voltage HD Harmonic A L3	01	E4	•	•
30487	244	Current HD Harmonic A L3	01	E6	•	•
30489	245	VRMS Harmonic B L3	01	E8	•	•
30491	246	IRMS Harmonic B L3	01	EA	•	•
30493	247	WATT Harmonic B L3	01	EC	•	x
30495	248	VAR Harmonic B L3	01	EE	•	x
30497	249	VA Harmonic B L3	01	F0	•	x
30499	250	PF Harmonic B L3	01	F2	•	x
30501	251	Voltage HD Harmonic B L3	01	F4	•	•
30503	252	Current HD Harmonic B L3	01	F6	•	•
30505	253	VRMS Harmonic C L3	01	F8	•	•
30507	254	IRMS Harmonic C L3	01	FA	•	•
30509	255	WATT Harmonic C L3	01	FC	•	x
30511	256	VAR Harmonic C L3	01	FE	•	x
30513	257	VA Harmonic C L3	02	0	•	x
30515	258	PF Harmonic C L3	02	2	•	x
30517	259	Voltage HD Harmonic C L3	02	4	•	•
30519	260	Current HD Harmonic C L3	02	6	•	•
30521	261	VRMS Harmonic D L3	02	8	•	•
30523	262	IRMS Harmonic D L3	02	A	•	•
30525	263	WATT Harmonic D L3	02	C	•	x
30527	264	VAR Harmonic D L3	02	E	•	x
30529	265	VA Harmonic D L3	02	10	•	x
30531	266	PF Harmonic D L3	02	12	•	x
30533	267	Voltage HD Harmonic D L3	02	14	•	•
30535	268	Current HD Harmonic D L3	02	16	•	•
30537	269	VRMS Harmonic E L3	02	18	•	•
30539	270	IRMS Harmonic E L3	02	1A	•	•
30541	271	WATT Harmonic E L3	02	1C	•	x
30543	272	VAR Harmonic E L3	02	1E	•	x
30545	273	VA Harmonic E L3	02	20	•	x
30547	274	PF Harmonic E L3	02	22	•	x
30549	275	Voltage HD Harmonic E L3	02	24	•	•
30551	276	Current HD Harmonic E L3	02	26	•	•
30553	277	VRMS Harmonic F L3	02	28	•	•
30555	278	IRMS Harmonic F L3	02	2A	•	•
30557	279	WATT Harmonic F L3	02	2C	•	x
30559	280	VAR Harmonic F L3	02	2E	•	x
30561	281	VA Harmonic F L3	02	30	•	x
30563	282	PF Harmonic F L3	02	32	•	x
30565	283	Voltage HD Harmonic F L3	02	34	•	•
30567	284	Current HD Harmonic F L3	02	36	•	•

PF : Power Factor HD : Harmonic Distortion

For 3 phase 3 wire L1: V12/11, L2: V23/12, L3: V31 / 13

Harmonic NB/C/D/E/JF denotes harmonic no entered in Power Quality Setup - Harmonic setup L1/L2/L3

15.2 Accessing Sag, Swell, Over Current data through MODBUS

The Sag, Swell, Over Current time stamping data can be accessed from the addresses shown in table 2. In this case Hour & Minute parameters are combined on one location and Date, Month & year parameters are combined on the next location.

For example: Suppose after reading register 30581, data read is 1051 in decimal. And reading register 30583, data read is 150313. Here in 1051, first two digits stand for hour i.e 10Hours and the next two digits stand for minute i.e 51 minutes. Also in 150313, first two digit denotes date i.e 15, next two denotes month i.e 3 and last to gives year when added to 2000.

So, For address 30581 10:51 is time for SAG 1.

For address 30583 15/03/2013 is date for SAG 1.

Sag, Swell, Over Current data is applicable in both 3P3W & 3P 4W.

Table 2: 3 X register (Sag, Swell, Over Current data)

Adress (Register)	Parameter No.	Parameter	Modbus Start Address Hex	
			High Byte	Low Byte
30581	291	Sag1 minute /Sag1 hour	02	44
30583	292	Sag1 date/ Sag1 month/ Sag1 year	02	46
30585	293	Sag2 minute /Sag2 hour	02	48
30587	294	Sag2 date/ Sag2 month/ Sag2 year	02	4A
30589	295	Sag3 minute /Sag3 hour	02	4C
30591	296	Sag3 date/ Sag3 month/ Sag3 year	02	4E
30593	297	Sag4 minute /Sag4 hour	02	50
30595	298	Sag4 date/ Sag4 month/ Sag4 year	02	52
30597	299	Sag5 minute /Sag5 hour	02	54
30599	300	Sag5 date/ Sag5 month/ Sag5 year	02	56
30601	301	Sag6 minute /Sag6 hour	02	58
30603	302	Sag6 date/ Sag6 month/ Sag6 year	02	5A
30605	303	Sag7 minute /Sag7 hour	02	5C
30607	304	Sag7 date/ Sag7 month/ Sag7 year	02	5E
30609	305	Sag8 minute /Sag8 hour	02	60
30611	306	Sag8 date/ Sag8 month/ Sag8 year	02	62
30613	307	Sag9 minute /Sag9 hour	02	64
30615	308	Sag9 date/ Sag9 month/ Sag9 year	02	66
30617	309	Sag10 minute /Sag10 hour	02	68
30619	310	Sag10 date/ Sag10 month/ Sag10 year	02	6A
30621	311	Sag11 minute /Sag11 hour	02	6C
30623	312	Sag11 date/ Sag11 month/ Sag11 year	02	6E
30625	313	Sag12 minute /Sag12 hour	02	70
30627	314	Sag12 date/ Sag12 month/ Sag12 year	02	72
30629	315	Sag13 minute /Sag13 hour	02	74
30631	316	Sag13 date/ Sag13 month/ Sag13 year	02	76
30633	317	Sag14 minute /Sag14 hour	02	78
30635	318	Sag14 date/ Sag14 month/ Sag14 year	02	7A
30637	319	Sag15 minute /Sag15 hour	02	7C
30639	320	Sag15 date/ Sag15 month/ Sag15 year	02	7E
30641	321	Sag16 minute /Sag16 hour	02	80
30643	322	Sag16 date/ Sag16 month/ Sag16 year	02	82
30645	323	Sag17 minute /Sag17 hour	02	84
30647	324	Sag17 date/ Sag17 month/ Sag17 year	02	86
30649	325	Sag18 minute /Sag18 hour	02	88
30651	326	Sag18 date/ Sag18 month/ Sag18 year	02	8A

30653	327	Sag19 minute /Sag19 hour	02	8C
30655	328	Sag19 date/ Sag19 month/ Sag19 year	02	8E
30657	329	Sag20 minute /Sag20 hour	02	90
30659	330	Sag20 date/ Sag20 month/ Sag20 year	02	92
30661	331	Sag21 minute /Sag21 hour	02	94
30663	332	Sag21 date/ Sag21 month/ Sag21 year	02	96
30665	333	Sag22 minute /Sag22 hour	02	98
30667	334	Sag22 date/ Sag22 month/ Sag22 year	02	9A
30669	335	Sag23 minute /Sag23 hour	02	9C
30671	336	Sag23 date/ Sag23 month/ Sag23 year	02	9E
30673	337	Sag24 minute /Sag24 hour	02	A0
30675	338	Sag24 date/ Sag24 month/ Sag24 year	02	A2
30677	339	Sag25 minute /Sag25 hour	02	A4
30679	340	Sag25 date/ Sag25 month/ Sag25 year	02	A6
30681	341	Sag26 minute /Sag26 hour	02	A8
30683	342	Sag26 date/ Sag26 month/ Sag26 year	02	AA
30685	343	Sag27 minute /Sag27 hour	02	AC
30687	344	Sag27 date/ Sag27 month/ Sag27 year	02	AE
30689	345	Sag28 minute /Sag28 hour	02	B0
30691	346	Sag28 date/ Sag28 month/ Sag28 year	02	B2
30693	347	Sag29 minute /Sag29 hour	02	B4
30695	348	Sag29 date/ Sag29 month/ Sag29 year	02	B6
30697	349	Sag30 minute /Sag30 hour	02	B8
30699	350	Sag30 date / Sag30 month / Sag30 year	02	BA
30701	351	Swell1 minute /Swell1 hour	02	BC
30703	352	Swell1 date/ Swell1 month/ Swell1 year	02	BE
30705	353	Swell2 minute /Swell2 hour	02	C0
30707	354	Swell2 date/ Swell2 month/ Swell2 year	02	C2
30709	355	Swell3 minute /Swell3 hour	02	C4
30711	356	Swell3 date/ Swell3 month/ Swell3 year	02	C6
30713	357	Swell4 minute /Swell4 hour	02	C8
30715	358	Swell4 date/ Swell4 month/ Swell4 year	02	CA
30717	359	Swell5 minute /Swell5 hour	02	CC
30719	360	Swell5 date/ Swell5 month/ Swell5 year	02	CE
30721	361	Swell6 minute /Swell6 hour	02	D0
30723	362	Swell6 date/ Swell6 month/ Swell6 year	02	D2
30725	363	Swell7 minute /Swell7 hour	02	D4
30727	364	Swell7 date/ Swell7 month/ Swell7 year	02	D6
30729	365	Swell8 minute /Swell8 hour	02	D8
30731	366	Swell8 date/ Swell8 month/ Swell8 year	02	DA
30733	367	Swell9 minute /Swell9 hour	02	DD
30735	368	Swell9 date/ Swell9 month/ Swell9 year	02	DE
30737	369	Swell10 minute /Swell10 hour	02	E0
30739	370	Swell10 date/ Swell10 month/ Swell10 year	02	E2
30741	371	Swell11 minute /Swell11 hour	02	E4
30743	372	Swell11 date/ Swell11 month/ Swell11 year	02	E6
30745	373	Swell12 minute /Swell12 hour	02	E8
30747	374	Swell12 date/ Swell12 month/ Swell12 year	02	EA
30749	375	Swell13 minute /Swell13 hour	02	EC

30751	376	Swell13 date/ Swell13 month/ Swell13 year	02	EE
30753	377	Swell14 minute /Swell14 hour	02	F0
30755	378	Swell14 date/ Swell14 month/ Swell14 year	02	F2
30757	379	Swell15 minute /Swell15 hour	02	F4
30759	380	Swell15 date/ Swell15 month/ Swell15 year	02	F6
30761	381	Swell16 minute /Swell16 hour	02	F8
30763	382	Swell16 date/ Swell16 month/ Swell16 year	02	FA
30765	383	Swell17 minute /Swell17 hour	02	FC
30767	384	Swell17 date/ Swell17 month/ Swell17 year	02	FE
30769	385	Swell18 minute /Swell18 hour	03	0
30771	386	Swell18 date/ Swell18 month/ Swell18 year	03	2
30773	387	Swell19 minute /Swell19 hour	03	4
30775	388	Swell19 date/ Swell19 month/ Swell19 year	03	6
30777	389	Swell20 minute /Swell20 hour	03	8
30779	390	Swell20 date/ Swell20 month/ Swell20 year	03	A
30781	391	Swell21 minute /Swell21 hour	03	C
30783	392	Swell21 date/ Swell21 month/ Swell15 year	03	E
30785	393	Swell22 minute /Swell22 hour	03	10
30787	394	Swell22 date/ Swell22 month/ Swell22 year	03	12
30789	395	Swell23 minute /Swell23 hour	03	14
30791	396	Swell23 date/ Swell23 month/ Swell23 year	03	16
30793	397	Swell24 minute /Swell24 hour	03	18
30795	398	Swell24 date/ Swell24 month/ Swell24 year	03	1A
30797	399	Swell25 minute /Swell25 hour	03	1C
30799	400	Swell25 date/ Swell25 month/ Swell25 year	03	1E
30801	401	Swell26 minute /Swell26 hour	03	20
30803	402	Swell26 date/ Swell26 month/ Swell26 year	03	22
30805	403	Swell27 minute /Swell27 hour	03	24
30807	404	Swell27 date/ Swell27 month/ Swell27 year	03	26
30809	405	Swell28 minute /Swell28 hour	03	28
30811	406	Swell28 date/ Swell28 month/ Swell28 year	03	2A
30813	407	Swell29 minute /Swell29 hour	03	2C
30815	408	Swell29 date/ Swell29 month/ Swell29 year	03	2E
30817	409	Swell30 minute /Swell30 hour	03	30
30819	410	Swell30 date/ Swell30 month/ Swell30 year	03	32
30821	411	Over Current1 minute /Over Current1 hour	03	34
30823	412	Over Current1 date/ Over Current1 month/ Over Current1 year	03	36
30825	413	Over Current2 minute /Over Current2 hour	03	38
30827	414	Over Current2 date/ Over Current2 month/ Over Current2 year	03	3A
30829	415	Over Current3 minute /Over Current3 hour	03	3C
30831	416	Over Current3 date/ Over Current3 month/ Over Current3 year	03	3E
30833	417	Over Current4 minute /Over Current4 hour	03	40
30835	418	Over Current4 date/ Over Current4 month/ Over Current4 year	03	42
30837	419	Over Current5 minute /Over Current5 hour	03	44
30839	420	Over Current5 date/ Over Current5 month/ Over Current5 year	03	46
30841	421	Over Current6 minute /Over Current6 hour	03	48
30843	422	Over Current6 date/ Over Current6 month/ Over Current6 year	03	4A
30845	423	Over Current7 minute /Over Current7 hour	03	4C
30847	424	Over Current7 date/ Over Current7 month/ Over Current7 year	03	4E

30849	425	Over Current8 minute /Over Current8 hour	03	50
30851	426	Over Current8 date/ Over Current8 month/ Over Current8 year	03	52
30853	427	Over Current9 minute /Over Current9 hour	03	54
30855	428	Over Current9 date/ Over Current9 month/ Over Current9 year	03	56
30857	429	Over Current10 minute /Over Current10 hour	03	58
30859	430	Over Current10 date/ Over Current10 month/ Over Current10 year	03	5A
30861	431	Over Current11 minute /Over Current11 hour	03	5C
30863	432	Over Current11 date/ Over Current11 month/ Over Current11 year	03	5E
30865	433	Over Current12 minute /Over Current12 hour	03	60
30867	434	Over Current12 date/ Over Current12 month/ Over Current12 year	03	62
30869	435	Over Current13 minute /Over Current13 hour	03	64
30871	436	Over Current13 date/ Over Current13 month/ Over Current13 year	03	66
30873	437	Over Current14 minute /Over Current14 hour	03	68
30875	438	Over Current14 date/ Over Current14 month/ Over Current14 year	03	6A
30877	439	Over Current15 minute /Over Current15 hour	03	6C
30879	440	Over Current15 date/ Over Current15 month/ Over Current15 year	03	6E
30881	441	Over Current16 minute /Over Current16 hour	03	70
30883	442	Over Current16 date/ Over Current16 month/ Over Current16 year	03	72
30885	443	Over Current17 minute /Over Current17 hour	03	74
30887	444	Over Current17 date/ Over Current17 month/ Over Current17 year	03	76
30889	445	Over Current18 minute /Over Current18 hour	03	78
30891	446	Over Current18 date/ Over Current18 month/ Over Current18 year	03	7A
30893	447	Over Current19 minute /Over Current19 hour	03	7C
30895	448	Over Current19 date/ Over Current19 month/ Over Current19 year	03	7E
30897	449	Over Current20 minute /Over Current20 hour	03	80
30899	450	Over Current20 date/ Over Current20 month/ Over Current20 year	03	82
30901	451	Over Current21 minute /Over Current21 hour	03	84
30903	452	Over Current21 date/ Over Current21 month/ Over Current21 year	03	86
30905	453	Over Current22 minute /Over Current22 hour	03	88
30907	454	Over Current22 date/ Over Current22 month/ Over Current22 year	03	8A
30909	455	Over Current23 minute /Over Current23 hour	03	8C
30911	456	Over Current23 date/ Over Current23 month/ Over Current23 year	03	8E
30913	457	Over Current24 minute /Over Current24 hour	03	90
30915	458	Over Current24 date/ Over Current24 month/ Over Current24 year	03	92
30917	459	Over Current25 minute /Over Current25 hour	03	94
30919	460	Over Current25 date/ Over Current25 month/ Over Current25 year	03	96
30921	461	Over Current26 minute /Over Current26 hour	03	98
30923	462	Over Current26 date/ Over Current26 month/ Over Current26 year	03	9A
30925	463	Over Current27 minute /Over Current27 hour	03	9C
30927	464	Over Current27 date/ Over Current27 month/ Over Current27 year	03	9E
30929	465	Over Current28 minute /Over Current28 hour	03	A0
30931	466	Over Current28 date/ Over Current28 month/ Over Current28 year	03	A2
30933	467	Over Current29 minute /Over Current29 hour	03	A4
30935	468	Over Current29 date/ Over Current29 month/ Over Current29 year	03	A6
30937	469	Over Current30 minute /Over Current30 hour	03	A8
30939	470	Over Current30 date/ Over Current30 month/ Over Current30 year	03	AA

15.3 Accessing 3 X for reading Time Of Day data

Time Of Day data can be read from 3 X register only after setting the 4 X register address 40083 (parameter No. 41 in 4 X register). For different values in 40083 different TOD data can be read. Settings for 40083 address are mentioned in table 3.

Table 3: TOD Data Configuration

Value in 40083	Type of data in 3 X register	Reference Table
0	Normal measurement data & Sag, Swell, Over Current Timestamps	Table 1 & Table 2
1	TOD Summary data (per date total energy & cost up to last 30 days & per month total energy & cost up to last 12 months)	Table 4
2	TOD zonewise active import energy & cost per date up to last 31 days	Table 5
3	TOD zonewise active export energy & cost per date up to last 31 days	
4	TOD zonewise reactive import energy & cost per date up to last 31 days	
5	TOD zonewise reactive export energy & cost per date up to last 31 days	
6	TOD zonewise apparent energy & cost per date up to last 31 days	

If value at 40083 is configured from 1 to 6, the corresponding data in 3 X register can be read for maximum 5 minutes. After that 40083 will automatically be configured as 0, and normal measured parameter will be held in 3 X register.

For Time Of Day data the units for energy and cost multiplier are decided on the settings of Pt primary value and CT primary value. Following table shows the unit of energy and cost multiplier for the different ranges of CT primary and PT primary.

CTPR* PTPR (VLL)* ROOT3 (KW)	Per month Energy Unit	Per month cost multiplier	Per day & per zone Energy unit	Per day & per zone cost multiplier
0 to <=900	kWh	1	kWh	1
>900 to <=90000	kWh	1000	kWh	1
>90000	MWh	1000	kWh	1000

For example, Suppose PT primary value is set as 500 and CT primary value is set as 5, then $5 * 500 * 1.732051 = 4330.127$. This is less than 900 KW. So the per month energy, per day energy & per zone energy will be in KW. Also cost multiplier for all cost will be 1.

In other case, if PT primary value is set as 692800 and CT primary value is set as 1157, then $1157 * 692800 * 1.732051 = 1388359273$. This is greater than 90000 KW. So the per month energy, per day energy & per zone energy will be in KW. Also cost multiplier for all cost will be 1000 i.e. if get value of cost as 5, cost should be.

Table 4: TOD Summary data

Adress (Register)	Parameter No.	Parameter	Modbus Start Address Hex	
			High Byte	Low Byte
30003	1	Current date timezone1 kWh import energy	00	2
30005	2	Current date timezone2 kWh import energy	00	4
30007	3	Current date timezone3 kWh import energy	00	6
30009	4	Current date timezone4 kWh import energy	00	8
30011	5	Current date timezone5 kWh import energy	00	A
30013	6	Current date timezone6 kWh import energy	00	C
30015	7	Current date timezone1 kWh export energy	00	E
30017	8	Current date timezone2 kWh export energy	00	10
30019	9	Current date timezone3 kWh export energy	00	12
30021	10	Current date timezone4 kWh export energy	00	14
30023	11	Current date timezone5 kWh export energy	00	16
30025	12	Current date timezone6 kWh export energy	00	18
30027	13	Current date timezone1 kVARh import energy	00	1A

30029	14	Current date timezone2 kVARh import energy	00	1C
30031	15	Current date timezone3 kVARh import energy	00	1E
30033	16	Current date timezone4 kVARh import energy	00	20
30035	17	Current date timezone5 kVARh import energy	00	22
30037	18	Current date timezone6 kVARh import energy	00	24
30039	19	Current date timezone1 kVARh export energy	00	26
30041	20	Current date timezone2 kVARh export energy	00	28
30043	21	Current date timezone3 kVARh export energy	00	2A
30045	22	Current date timezone4 kVARh export energy	00	2C
30047	23	Current date timezone5 kVARh export energy	00	2E
30049	24	Current date timezone6 kVARh export energy	00	30
30051	25	Current date timezone1 kVAh energy	00	32
30053	26	Current date timezone2 kVAh energy	00	34
30055	27	Current date timezone3 kVAh energy	00	36
30057	28	Current date timezone4 kVAh energy	00	38
30059	29	Current date timezone5 kVAh energy	00	3A
30061	30	Current date timezone6 kVAh energy	00	3C
30063	31	Date 1 kWh import energy	00	3E
30065	32	Date 2 kWh import energy	00	40
30067	33	Date 3 kWh import energy	00	42
30119	59	Date 29 kWh import energy	00	76
30121	60	Date 30 kWh import energy	00	78
30123	61	Date 31 kWh import energy	00	7A
30125	62	Date 1 kWh export energy	00	7C
30127	63	Date 2 kWh export energy	00	7E
30129	64	Date 3 kWh export energy	00	80
30183	91	Date 30 kWh export energy	00	B6
30185	92	Date 31 kWh export energy	00	B8
30187	93	Date 1 kVARh import energy	00	BA
30189	94	Date 2 kVARh import energy	00	BC
30191	95	Date 3 kVARh import energy	00	BE
30243	121	Date 29 kVARh import energy	00	F2
30245	122	Date 30 kVARh import energy	00	F4
30247	123	Date 31 kVARh import energy	00	F6
30249	124	Date 1 kVARh export energy	00	F8
30251	125	Date 2 kVARh export energy	00	FA
30307	153	Date 30 kVARh export energy	01	32
30309	154	Date 31 kVARh export energy	01	34
30311	155	Date 1 kVAh energy	01	36
30313	156	Date 2 kVAh energy	01	38
30369	184	Date 30 kVAh energy	01	70
30371	185	Date 30 kVAh energy	01	72
30373	186	month 1 kWh import energy	01	74
30375	187	month 2 kWh import energy	01	76
30393	196	month 11 kWh import energy	01	88
30395	197	month 12 kWh import energy	01	8A
30397	198	month 1 kWh export energy	01	8C
30399	199	month 2 kWh export energy	01	8E
30417	208	month 11 kWh export energy	01	A0

30419	209	month 12 kWh export energy	01	A2
30421	210	month 1 kVARh import energy	01	A4
30423	211	month 2 kVARh import energy	01	A6
30441	220	month 11 kVARh import energy	01	B8
30443	221	month 12 kVARh import energy	01	BA
30445	222	month 1 kVARh export energy	01	BC
30447	223	month 2 kVARh export energy	01	BE
30465	232	month 11 kVARh export energy	01	D0
30467	233	month 12 kVARh export energy	01	D2
30469	234	month 1 kVAh energy	01	D4
30471	235	month 2 kVAh energy	01	D6
30489	244	month 11 kVAh energy	01	E8
30491	245	month 12 kVAh energy	01	EA
30493	246	Date 1 kWh import cost	01	EC
30495	247	Date 2 kWh import cost	01	EE
30551	275	Date 30 kWh import cost	02	26
30553	276	Date 31 kWh import cost	02	28
30555	277	Date 1 kWh export cost	02	2A
30557	278	Date 2 kWh export cost	02	2C
30613	306	Date 30 kWh export cost	02	64
30615	307	Date 31 kWh export cost	02	66
30617	308	Date 1 kVARh import cost	02	68
30619	309	Date 2 kVARh import cost	02	6A
30675	337	Date 30 kVARh import cost	02	A2
30677	338	Date 31 kVARh import cost	02	A4
30679	339	Date 1 kVARh export cost	02	A6
30681	340	Date 1 kVARh export cost	02	A8
30737	368	Date 30 kVARh export cost	02	E0
30739	369	Date 31 kVARh export cost	02	E2
30741	370	Date 1 kVAh cost	02	E4
30743	371	Date 2 kVAh cost	02	E6
30799	399	Date 30 kVAh cost	03	1W
30801	400	Date 31 kVAh cost	03	20
30803	401	month 1 kWh import cost	03	22
30805	402	month 2 kWh import cost	03	24
30823	411	month 11 kWh import cost	03	36
30825	412	month 12 kWh import cost	03	38
30827	413	month 1 kWh export cost	03	3A
30829	414	month 2 kWh export cost	03	3C
30847	423	month 11 kWh export cost	03	4E
30849	424	month 12 kWh export cost	03	50
30851	425	month 1 kVARh import cost	03	52
30853	426	month 2 kVARh import cost	03	54
30871	435	month 11 kVARh import cost	03	66
30873	436	month 12 kVARh import cost	03	68
30875	437	month 1 kVARh export cost	03	6A
30877	438	month 12 kVARh export cost	03	6C
30895	447	month 11 kVARh export cost	03	7E
30897	448	month 12 kVARh export cost	03	80

30899	449	month 1 kVAh cost	03	82
30901	450	month 1 kVAh cost	03	84
30919	459	month 11 kVAh cost	03	96
30921	460	month 12 kVAh cost	03	98
30923	461	Current date timezone1 kWh import cost	03	9A
30925	462	Current date timezone2 kWh import cost	03	pC
30927	463	Current date timezone3 kWh import cost	03	pE
30929	464	Current date timezone4 kWh import cost	03	A0
30931	465	Current date timezone5 kWh import cost	03	A2
30933	466	Current date timezone6 kWh import cost	03	A4
30935	467	Current date timezone1 kWh export cost	03	A6
30937	468	Current date timezone2 kWh export cost	03	A8
30939	469	Current date timezone3 kWh export cost	03	AA
30941	470	Current date timezone4 kWh export cost	03	AC
30943	471	Current date timezone5 kWh export cost	03	AE
30945	472	Current date timezone6 kWh export cost	03	B0
30947	473	Current date timezone1 kVARh import cost	03	B2
30949	474	Current date timezone2 kVARh import cost	03	B4
30951	475	Current date timezone3 kVARh import cost	03	B6
30953	476	Current date timezone4 kVARh import cost	03	B8
30955	477	Current date timezone5 kVARh import cost	03	BA
30957	478	Current date timezone6 kVARh import cost	03	BC
30959	479	Current date timezone1 kVARh export cost	03	BE
30961	480	Current date timezone2 kVARh export cost	03	C0
30963	481	Current date timezone3 kVARh export cost	03	C2
30965	482	Current date timezone4 kVARh export cost	03	C4
30967	483	Current date timezone5 kVARh export cost	03	C6
30969	484	Current date timezone6 kVARh export cost	03	C8
30971	485	Current date timezone1 kVAh cost	03	CA
30973	486	Current date timezone2 kVAh cost	03	CC
30975	487	Current date timezone3 kVAh cost	03	CE
30977	488	Current date timezone4 kVAh cost	03	D0
30979	489	Current date timezone5 kVAh cost	03	D2
30981	490	Current date timezone6 kVAh cost	03	D4

15.4 Accessing TOD Zone wise Data of Last 31 days:

For reading zone wise data proper value should be written at location 400083 as mentioned in table 3. The zone wise TOD energy & cost are stored on the location of the particular date. For example if today is 15 march 2013, then TOD energy & cost of today will be located at date 15 zone wise data (address 30337 to address 30359 of 3 X register). Similarly data of 25th of February will be located on date 25 zone wise data (address 30577 to address 30599 of 3 X register). Following table shows respective 3 X addresses to read.

Table 5: TOD Zonewise data (kWh (imp/exp) / kVARh (imp/exp) / kVAh)

Adress (Register)	Parameter No.	Parameter	Modbus Start Adress Hex	
			High Byte	Low Byte
30001	1	timezone1 date 1 Energy	00	0
30003	2	timezone2 date 1 Energy	00	2
30005	3	timezone3 date 1 Energy	00	4
30007	4	timezone4 date 1 Energy	00	6
30009	5	timezone5 date 1 Energy	00	8

30011	6	timezone6 date 1 Energy	00	A
30013	7	timezone1 date 1 cost	00	C
30015	8	timezone2 date 1 cost	00	E
30017	9	timezone3 date 1 cost	00	10
30019	10	timezone4 date 1 cost	00	12
30021	11	timezone5 date 1 cost	00	14
30023	12	timezone6 date 1 cost	00	16
30025	13	timezone1 date 2 Energy	00	18
30035	18	timezone6 date 2 Energy	00	22
30037	19	timezone1 date 2 cost	00	24
30047	24	timezone6 date 2 cost	00	2E
30049	25	timezone1 date 3 Energy	00	30
30059	30	timezone6 date 3 Energy	00	3A
30061	31	timezone1 date 3 cost	00	3C
30071	36	timezone6 date 3 cost	00	46
30337	169	timezone1 date 15 Energy	01	50
30347	174	timezone6 date 15 Energy	01	5A
30349	175	timezone1 date 15 cost	01	5C
30359	180	timezone6 date 15 cost	02	66
30673	337	timezone1 date 29 Energy	02	A0
30683	342	timezone6 date 29 Energy	02	AA
30685	343	timezone1 date 29 cost	02	AC
30695	348	timezone6 date 29 cost	02	B6
30697	349	timezone1 date 30 Energy	02	B8
30707	354	timezone6 date 30 Energy	02	C2
30709	355	timezone1 date 30 cost	02	C4
30719	360	timezone6 date 30 cost	02	CE
30721	361	timezone1 date 31 Energy	02	D0
30723	362	timezone2 date 31 Energy	02	D2
30725	363	timezone3 date 31 Energy	02	D4
30727	364	timezone4 date 31 Energy	02	D6
30729	365	timezone5 date 31 Energy	02	D8
30731	366	timezone6 date 31 Energy	02	DA
30733	367	timezone1 date 31 cost	02	DC
30735	368	timezone2 date 31 cost	02	DE
30737	369	timezone3 date 31 cost	02	E0
30739	370	timezone4 date 31 cost	02	E2
30741	371	timezone5 date 31 cost	02	E4
30743	372	timezone6 date 31 cost	02	E6

15.5 Accessing 4 X register for reading & Writing:

Each setting is held in the 4X registers. ModBus code 03 is used to read the current setting and code 16 is used to write/change the setting. Refer **TABLE 6** for 4X Register addresses.

Example: Reading System type

System type: Start address = 0A (Hex)

Number of registers = 02

Note: Number of registers = Number of parameters x 2

Query:

01 (Hex)	03 (Hex)	00 (Hex)	0A (Hex)	00 (Hex)	02 (Hex)	E4 (Hex)	09 (Hex)
Device Address	Function Code	Start Address High	Start Address Low	Number of Registers Hi	Number of Registers Lo	CRC Low	CRC High

Start Address High: Most significant 8 bits of starting address of the parameter requested.

Start Address low: Least significant 8 bits of starting address of the parameter requested.

Number of register Hi: Most significant 8 bits of Number of registers requested.

Number of register Lo: Least significant 8 bits of Number of registers requested.

(Note: Two consecutive 16 bit register represent one parameter.)

Response: System Type (3phase 4 wire = 3)

01 (Hex)	03 (Hex)	04 (Hex)	40 (Hex)	40 (Hex)	00 (Hex)	00 (Hex)	EE (Hex)	27 (Hex)
Device Address	Function Code	Byte Count	Data Register1 High Byte	Data Register1 Low Byte	Data Register2 High Byte	Data Register2 Low Byte	CRC Low	CRC High

Byte Count : Total number of data bytes received.

Data register 1 High Byte: Most significant 8 bits of Data register 1 of the parameter requested.

Data register 1 Low Byte: Least significant 8 bits of Data register 1 of the parameter requested.

Data register 2 High Byte: Most significant 8 bits of Data register 2 of the parameter requested.

Data register 2 Low Byte: Least significant 8 bits of Data register 2 of the parameter requested.

(Note: Two consecutive 16 bit register represent one parameter.)

Example : Writing System type

System type : Start address = 0A (Hex)

Number of registers = 02

Query: (Change System type to 3phase 3wire = 2)

01 (Hex)	10 (Hex)	00 (Hex)	0A (Hex)	00 (Hex)	02 (Hex)	04 (Hex)	40 (Hex)	00 (Hex)	00 (Hex)	00 (Hex)	66 (Hex)	10 (Hex)
Device Address	Function Code	Start Address High	Start Address Low	Number of Registers Hi	Number of Registers Low	Byte Count	Data Register1 High Byte	Data Register1 Low Byte	Data Register2 High Byte	Data Register2 Low Byte	CRC Low	CRC High

Byte Count: Total number of data bytes received.

Data register 1 High Byte: Most significant 8 bits of Data register 1 of the parameter requested.

Data register 1 Low Byte: Least significant 8 bits of Data register 1 of the parameter requested.

Data register 2 High Byte: Most significant 8 bits of Data register 2 of the parameter requested.

Data register 2 Low Byte: Least significant 8 bits of Data register 2 of the parameter requested.

(Note: Two consecutive 16 bit register represent one parameter.)

Response:

01 (Hex)	10 (Hex)	00 (Hex)	0A (Hex)	00 (Hex)	02 (Hex)	61 (Hex)	CA (Hex)
Device Address	Function Code	Start Address High	Start Address Low	Number of Registers Hi	Number of Registers Low	CRC Low	CRC High

Start Address High: Most significant 8 bits of starting address of the parameter requested.

Start Address low: Least significant 8 bits of starting address of the parameter requested.

Number of register Hi: Most significant 8 bits of Number of registers requested.

Number of register Lo: Least significant 8 bits of Number of registers requested.

(Note: Two consecutive 16 bit register represent one parameter.)

TABLE 6: 4 X register addresses

Adress (Register)	Parameter No.	Parameter	Read / Write	Modbus Start Adress Hex	
				High Byte	Low Byte
40003	1	Demand Period	R/Wp	00	02
40005	2	Energy Resolution	R/Wp	00	04
40007	3	System Voltage	R	00	06
40009	4	System Current	R	00	08
40011	5	System Type	R/Wp	00	0A
40013	6	Pulse Width	R/Wp	00	0C
40015	7	Reset Parameters	Wp	00	0E
40019	9	RS485 Set-up Code	R/Wp	00	12
40021	10	Node Address	R/Wp	00	14
40023	11	Pulse Divisor	R/Wp	00	16
40033	16	PT Primary	R/Wp	00	20
40035	17	CT Primary	R/Wp	00	22
40037	18	System Power	R	00	24
40039	19	Energy Digit Reset Count	R/Wp	00	26
40041	20	Register Order / Word Order	R/Wp	00	28
40043	21	CT Secondary	R/Wp	00	2A
40045	22	PT Secondary	R/Wp	00	2C
40071	35	Password	R/W	00	46
40079	39	30mA Noise Current Elimination	R/Wp	00	4E
40081	40	Energy uodation rate	R/Wp	00	50
40083	41	Tou data & Energy Type	Wp	00	52
40097	48	serial number	R	00	60
40099	49	model no.	R	00	62
40101	50	modbus version no.	R	00	64
40103	51	display version no.	R	00	66
40105	52	weekend	R/Wp	00	68
40107	53	holiday no.	R/Wp	00	6A
40109	54	holiday date	R/Wp	00	6C
40111	55	holiday month	R/Wp	00	6E
40113	56	alternate day no.	R/Wp	00	70
40115	57	alternate day date	R/Wp	00	72
40117	58	alternate day month	R/Wp	00	74
40119	59	profile 1	R/Wp	00	76
40121	60	profile 2	R/Wp	00	78
40123	61	profile 3	R/Wp	00	7A
40125	62	profile 4	R/Wp	00	7C
40127	63	season no.	R/Wp	00	7E
40129	64	season start date	R/Wp	00	80
40131	65	season start month	R/Wp	00	82
40133	66	day type no.	R/Wp	00	84
40135	67	time zone no.	R/Wp	00	86
40137	68	time zone minute	R/Wp	00	88
40139	69	time zone hour	R/Wp	00	8A
40141	70	time zone profile	R/Wp	00	8C
40143	71	Sag Threshold Set	R/Wp	00	8E
40145	72	Swell Threshold Set	R/Wp	00	90

40019	Rs485 Set-up Code	This address is used to set the baud rate, Parity, Number of stop bits. Refer to TABLE 7 for details.																
40021	Node Address	This register address is used to set Device address between 1 to 247 .																
40033	PT Primary	This address allows the user to set PT Primary value. The range of value is 100 to 692.BkV L -L depends on the per phase 666.6MVA Restriction of power combined with CT primary																
40035	CT Primary	This address allows the user to set CT Primary value. The range of value is 1 to 9999 A & also depends on the per phase 666.6MVA Restriction of power combined with PT primary																
40037	Sys Power	System Power (Read Only) is the Nominal system power based on the values of Nominal system volts and Nominal system current.																
40039	Energy Digit Reset Count	This address allows user to set maximum energy digits count after which energy will roll over to zero. Valid values for this address are 7, 8, 9. These values decides the rollover count of energy in 3X register on MODBUS.																
40041	Word Order	Word Order controls the order in which Multifunction Meter receives or sends floating - point numbers:- normal or reversed register order . In normal mode, the two registers that make up a floating point numbers are sent most significant bytes first. In reversed register mode, the two registers that make up a floating point numbers are sent least significant bytes first. To set the mode, write the value '2141.0' into this register-the instrument will detect the order used to send this value and set that order for all ModBus transaction involving floating point numbers.																
40043	CT secondary	This address is used to read and write the CT secondary value. Write one of the following values to this address. 1: 1A CT secondary 5: 5A CT secondary writing any other value will return an error.																
40045	PT secondary	This address is used to read and write the PT secondary value. Valid range for PT secondary value is from 100 to 500V L-L. Writing any other value will return an error.																
40071	Password	This address is used to set & reset the password. Valid Range of Password can be set is 0000 - 9999. 1) If password lock is present & if this location is read it will return zero. 2) If Password lock is absent & if this location is read it will return One. 3) If password lock is present & to disable this lock first send valid password to this location then write "0000" to this location 4) If password lock is present & to modify 4X parameter first send valid password to this location so that 4X parameter will be accessible for modification. 5) If for in any of the above case invalid password is send then meter will return exceptional error 2.																
40079	30mA Noise current Elimination	This address is used to activate or de-activate the 30 mA noise current elimination write 0: Deactivate 30 (Decimal): Activate Writing any other value will return an error.																
40081	Energy Update Rate	This address is used to specify update rate of energy in corresponding 3X registers. The valid values for update rate are from 1 to 60 min. Writing any other value will return an error.																
40083	TOD data On MODBUS	This address allows to access TOD data in 3 X register. Writing values from 0 to 6 gives different data in 3 X register. Refer table 3 for details.																
40097	Serial No.	This address shows the serial no. configured at factory.																
40099	Model No.	This address shows the model no. for identification of model. For PQM model no is 3481.																
40101	Add on VER No.	This address shows the version no of add - on card.																
40103	Display VER No.	This address shows the version no of display card.																
40105	Weekend Select	This address allows to select days as weekends. <table border="1" style="margin-left: auto; margin-right: auto;"> <tr> <td></td> <td>S</td> <td>S</td> <td>F</td> <td>T</td> <td>W</td> <td>T</td> <td>M</td> </tr> <tr> <td></td> <td>1</td> <td>0</td> <td>0</td> <td>0</td> <td>0</td> <td>0</td> <td>1</td> </tr> </table> <p style="text-align: right;">0 = DESELECT 1 = SELECT</p> <p>For example if user wants to select Sunday and Monday as weekend according to the above register user has to select the S & M as 1, and then user has to write its decimal representation on modbus location 40105 of 4x register i.e. user has to write 65 on 40105.</p>		S	S	F	T	W	T	M		1	0	0	0	0	0	1
	S	S	F	T	W	T	M											
	1	0	0	0	0	0	1											
40107	Holiday no.	This address is used to select holiday no of which data is to be read from or written to addresses 40109 & 40111. Valid range for holiday no is 1 to 30. Writing any other value will return an error.																

40109	Holiday Date	This address allows to read or write the value of date of holiday no specified in address 40107.												
40111	Holiday Month	This address allows to read or write the value of month of holiday no specified in address 40107.												
40113	Alternate day No.	This address is used to select Alternate day no of which data is to be read from or written to addresses 40115 & 40117. Valid range for Alternate day no is 1 to JO. Writing any other value will return an error.												
40115	Alternate day, Date	This address allows to read or write the value of date of Alternate day no specified in address 40113.												
40117	Alternate day, Month	This address allows to read or write the value of month of Alternate day no specified in address 40113.												
40119	Profile 1	This address allows to enter tariff rate for Profile 1. Valid range for tariff rate is 0.001 to 299.0.												
40121	Profile 2	This address allows to enter tariff rate for Profile 2. Valid range for tariff rate is 0.001 to 299.0.												
40123	Profile 3	This address allows to enter tariff rate for Profile 3. Valid range for tariff rate is 0.001 to 299.0.												
40125	Profile 4	This address allows to enter tariff rate for Profile 4. Valid range for tariff rate is 0.001 to 299.0.												
40127	Season No.	This address is used to select season no of which data is to be read from or written to addresses 40129 & 40131. Valid range for season no is 1 to 4. Writing any other value will return an error.												
40129	Season Date	This address allows to read or write the value of date of season no specified in address 40127.												
40131	Season Month	This address allows to read or write the value of month of season no specified in address 40127.												
40133	Day type	This address is used to select day type of season specified in address 40127. Valid value for day type are from 1 to 4. Writing any other value will return an error. 1 -Weekdays 2-Weekends 3 - Holidays 4 -Alternate days												
40135	Timezone No.	This address is used to select time zone no of season specified in address 40127 & day type specified in address 40133. Valid range for time zone no is 1 to 6. Writing any other value will return an error. Time zones must be entered in sequential order. First time zone is default configured as 00:00												
40137	Time zone Hour	This address allows to read or write the value of hour of time zone no specified in address 40135.												
40139	Time zone Minute	This address allows to read or write the value of minute of time zone specified in address 40135.												
40141	Time zone Profile Rate	This address allows to read or write the tariff rate no of time zone specified in address 40135.												
40143	Sag Threshold Set	This address allows to enter threshold value for sag detection. Valid range for sag threshold is 10 to 90 % of nominal.												
40145	Swell Threshold Set	40145 Swell Threshold This address allows to enter threshold value for swell detection. Valid range for swell threshold is 110 to 150 % of nominal voltage.												
40147	Over Current Threshold Set	This address allows to enter threshold value for over current detection. Valid range for overcurrent threshold is 110 to 150% of nominal current.												
40149	Phase No for Harmonic Setup	This address is used to select phase no of which data is to be read from or written to addresses from 40151 to 40161. Valid range for phase no is 1 to 3. <table border="1" data-bbox="504 1397 1050 1563"> <thead> <tr> <th>Phase No</th> <th>3p4w</th> <th>3p3w</th> </tr> </thead> <tbody> <tr> <td>1</td> <td>L1</td> <td>L12</td> </tr> <tr> <td>2</td> <td>L2</td> <td>L23</td> </tr> <tr> <td>3</td> <td>L3</td> <td>L13</td> </tr> </tbody> </table>	Phase No	3p4w	3p3w	1	L1	L12	2	L2	L23	3	L3	L13
Phase No	3p4w	3p3w												
1	L1	L12												
2	L2	L23												
3	L3	L13												
40151	Harmonic A	This address allows to read or write the value of harmonic A of phase no specified. Harmonic Range is 2-56.												
40153	Harmonic B	This address allows to read or write the value of harmonic B of phase no specified. Harmonic Range is 2-56.												
40155	Harmonic C	This address allows to read or write the value of harmonic C of phase no specified. Harmonic Range is 2-56.												
40157	Harmonic D	This address allows to read or write the value of harmonic D of phase no specified. Harmonic Range is 2-56.												
40159	Harmonic E	This address allows to read or write the value of harmonic E of phase no specified. Harmonic Range is 2-56.												
40161	Harmonic F	This address allows to read or write the value of harmonic F of phase no specified. Harmonic Range is 2-56.												
40163	RTC Minute	This address allows to read or write the value of minute of RTC.												
40165	RTC Hour	This address allows to read or write the value of Hour of RTC.												

40167	RTC Date	This address allows to read or write the value of Date of RTC.
40169	RTC month	This address allow to read or write the value of month of RTC.
40171	RTC Year	This address allows to read or write the value of Year of RTC.
40173	Brightness	This address allows to read or set the value of brightness of display LCD. The valid range of values for brightness are from 2 to 102.
40175	Contrast	This address allows to read or set the value of contrast of display LCD. The valid range of values for contrast are from 6 to 28.
40203	Red Color Code for L1	This address allows to read or set the value of Red component of color used to display phase 1 parameters. The valid range is 0 to 255.
40205	Green Color Code for L1	This address allows to read or set the value of Green component of color used to display phase 1 parameters. The valid range is 0 to 255.
40207	Blue Color Code for L1	This address allows to read or set the value of Blue component of color used to display phase 1 parameters. The valid range is 0 to 255.
40209	Red Color Code for L2	This address allows to read or set the value of Red component of color used to display phase 2 parameters. The valid range is 0 to 255.
40211	Green Color Code for L2	This address allows to read or set the value of Green component of color used to display phase 2 parameters. The valid range is 0 to 255.
40213	Blue Color Code for L2	This address allows to read or set the value of Blue component of color used to display phase 2 parameters. The valid range is 0 to 255.
40215	Red Color Code for L3	This address allows to read or set the value of Red component of color used to display phase 3 parameters. The valid range is 0 to 255.
40217	Green Color Code for L3	This address allows to read or set the value of Green component of color used to display phase 3 parameters. The valid range is 0 to 255.
40219	Blue Color Code for L3	This address allows to read or set the value of Blue component of color used to display phase 3 parameters. The valid range is 0 to 255.

Table 7: RS485 Set-up Code

Baud Rate	Parity	Stop Bit	Decimal value
4800	NONE	1	0
4800	NONE	2	1
4800	EVEN	1	2
4800	ODD	1	3
9600	NONE	1	4
9600	NONE	2	5
9600	EVEN	1	6
9600	ODD	1	7
19200	NONE	1	8
19200	NONE	2	9
19200	EVEN	1	10
19200	ODD	1	11
38400	NONE	1	12
38400	NONE	2	13
38400	EVEN	1	14
38400	ODD	1	15

NOTE: Codes not listed in the table above may give rise to unpredictable results including loss of communication. Exercise caution when attempting to change mode via direct Modbus writes.

15.6 User Assignable Modbus Register

The Multifunction Energy Meter contains 20 user assignable registers in the address range of 0x2200 (38705) to 0x2226 (38743) (see TABLE 8). Any of the parameter addresses (3X register addresses TABLE 1) accessible in the instrument can be mapped to these 20 user assignable registers.

Parameters (3X registers addresses) that resides in different locations may be accessed by the single request by re-mapping them to adjacent address in the user assignable registers area.

The actual address of the parameters (3X registers addresses) which are to be accessed via address 0x2200 to 0x2226 are specified in 4X Register 0x2200 to 0x2213. (see TABLE 9)

TABLE 8: User Assignable 3X Data Registers

Adress (Register)	Parameter Number	Assignable Register	Modbus Start Adress Hex	
			High Byte	Low Byte
38705	4353	Assignable Reg 1	22	00
38707	4354	Assignable Reg 2	22	02
38709	4355	Assignable Reg 3	22	04
38711	4356	Assignable Reg 4	22	06
38713	4357	Assignable Reg 5	22	08
38715	4358	Assignable Reg 6	22	0A
38717	4359	Assignable Reg 7	22	0C
38719	4360	Assignable Reg 8	22	0E
38721	4361	Assignable Reg 9	22	10
38723	4362	Assignable Reg 10	22	12
38725	4363	Assignable Reg 11	22	14
38727	4364	Assignable Reg 12	22	16
38729	4365	Assignable Reg 13	22	18
38731	4366	Assignable Reg 14	22	1A
38733	4367	Assignable Reg 15	22	1C
38735	4368	Assignable Reg 16	22	1E
38737	4369	Assignable Reg 17	22	20
38739	4370	Assignable Reg 18	22	22
38741	4371	Assignable Reg 19	22	24
38743	4372	Assignable Reg 20	22	26

TABLE 9: User Assignable mapping register (4X register)

Adress (Register)	Parameter Number	Assignable Register	Modbus Start Address Hex	
			High Byte	Low Byte
48705	4353	Mapped Add for register #0x2200	22	00
48706	4354	Mapped Add for register #0x2202	22	01
48707	4355	Mapped Add for register #0x2204	22	02
48708	4356	Mapped Add for register #0x2206	22	03
48709	4357	Mapped Add for register #0x2208	22	04
48710	4358	Mapped Add for register #0x220A	22	05
48711	4359	Mapped Add for register #0x220C	22	06
48712	4360	Mapped Add for register #0x220E	22	07
48713	4361	Mapped Add for register #0x2210	22	08
48714	4362	Mapped Add for register #0x2212	22	09
48715	4363	Mapped Add for register #0x2214	22	0A
48716	4364	Mapped Add for register #0x2216	22	0B
48717	4365	Mapped Add for register #0x2218	22	0C
48718	4366	Mapped Add for register #0x221A	22	0D
48719	4367	Mapped Add for register #0x221C	22	0E
48720	4368	Mapped Add for register #0x221E	22	0F
48721	4369	Mapped Add for register #0x2220	22	10
48722	4370	Mapped Add for register #0x2222	22	11
48723	4371	Mapped Add for register #0x2224	22	12
48724	4372	Mapped Add for register #0x2226	22	13

Example:

Assigning parameter to User Assignable Registers:

To access the voltage2 (3X address 0x0002) and Power Factor1 (3X address 0x001E) through user assignable register assign these addresses to 4x register (TABLE 7) 0x2200 and 0x2201 respectively.

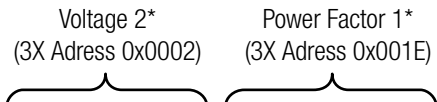

Assigning Query:

01 (Hex)	10 (Hex)	22 (Hex)	00 (Hex)*	00 (Hex)*	02 (Hex)*	04 (Hex)	00 (Hex)	02 (Hex)	00 (Hex)	1E (Hex)	52 (Hex)	C6 (Hex)
Device Address	Function Code	Start Address High	Start Address Low	Number of Registers Hi	Number of Registers Lo	Byte Count	Data Register1 High Byte	Data Register1 Low Byte	Data Register2 High Byte	Data Register2 Low Byte	CRC Low	CRC High

Response:

01 (Hex)	10 (Hex)	22 (Hex)	00 (Hex)	00 (Hex)	02 (Hex)	4B (Hex)	B0 (Hex)
Device Address	Function Code	Start Address High	Start Address Low	Number of Registers Hi	Number of Registers Lo	CRC Low	CRC High

Reading Parameter data through User Assignable Registers:

In assigning query Voltage 2 & Power Factor 1 parameters were assigned to 0x 2200 & 0x2201 (TABLE 7) which will point to user assignable 3x registers 0x2200 and 0x2202 (TABLE 6). So to read Voltage2 and Power Factor1 data reading query should be as below.

Query:

01 (Hex)	04 (Hex)	22 (Hex)	00 (Hex)	00 (Hex)	04 (Hex)**	FB (Hex)	B1 (Hex)
Device Address	Function Code	Start Address High	Start Address Low	Number of Registers Hi	Number of Registers Lo	CRC Low	CRC High

Start Address High: Most significant 8 bits of starting address of User assignable register.

Start Address low: Least significant 8 bits of starting address of User assignable register.

Number of register Hi: Most significant 8 bits of Number of registers requested.

Number of register Lo: Least significant 8 bits of Number of registers requested.

****Note:** Two consecutive 16 bit register represent one parameter. Since two parameters are requested four registers are required.

Response:

		Voltage 2 Data					Power Factor 1 Data						
01 (Hex)	04 (Hex)	08 (Hex)	43 (Hex)*	5B (Hex)*	4E (Hex)*	04 (Hex)	3F (Hex)	80 (Hex)	00 (Hex)	00 (Hex)	79 (Hex)	3F (Hex)	
Device Address	Function Code	Byte Count	Data Register-1 High Byte	Data Register-1 Low Byte	Data Register-2	Data Register-2 Low Byte	Data Register-3 High Byte	Data Register-3 Low Byte	Data Register-4	Data Register-4 Low Byte	CRC Low	CRC High	

(Starting Address)	User Assignable mapping Register (4x Register Table7)	(Starting Address)	User Assignable mapping Register (4x Register Table6)	
0x2200	Voltage 2 (0x0002)	0x2200	0x2200 (16 bit)	0x2201 (16 bit)
0x2201	Power factor 1 (0x001E)	0x2202	0x2202 (16 bit)	0x2203 (16 bit)
0x2202	Wh Import (0x0048)	0x2204	0x2204 (16 bit)	0x2205 (16 bit)
0x2203	Frequency (0x0046)	0x2206	0x2206 (16 bit)	0x2207 (16 bit)
⋮	⋮	⋮	⋮	⋮
0x2212	Current 1 (0x0006)	0x2224	0x2224 (16 bit)	0x2225 (16 bit)
0x2213	VAh (0x0050)	0x2226	0x2226 (16 bit)	0x2227 (16 bit)

To get the data through User Assignable Register go through the following steps:

- 1) Assign starting addresses (TABLE 1) of parameters of interest to a "User assignable mapping registers" in a sequence in which they are to be accessed (see section "Assigning Parameter to User Assignable Registers").
- 2) Once the parameters are mapped data can be acquired by using "User assignable data register" Starting address. i.e to access data of Voltage2, Power factor1, Wh import, Frequency send query with starting address 0x200 with number of register 8 or individually parameters can be accessed. For example, if current1 is to be accessed use starting address 0x212. (See section "Reading Parameter data through User Assignable Registers").

