



GEWINDESCHNEID- WERKZEUGE

FASCINATION  PRECISION®

Artikel- und Anwendungsübersicht:



Werkstoff	Oberfläche	DIN	Form	rechts / linksschneidend	Gewinde	Festigkeitsklassen	Nennmaß	Art. Nr.	Seite
HSS		DIN 352			M	800 N/mm²	M 2 - M 52	230 020 - 230 520	142
HSS		DIN 352			M	800 N/mm²	M 3 - M 20	230 030 Li - 230 200 Li	142
HSSE Co 5		DIN 352			M	1000 N/mm²	M 2 - M 24	230 020 E - 230 240 E	142
HSS		DIN 2181			MF	800 N/mm²	MF 3 - MF 52	235 030 - 235 520	144
HSS		DIN 5157			G (BSP)	800 N/mm²	G 1/8 - G 2"	236 018 - 236 020	146
HSS		DIN 352			Ww (BSW)	800 N/mm²	1/16 - 2"	246 116 - 246 020	147
HSS		DIN 352			UNC	800 N/mm²	Nr. 2 - 2"	246 020 UNC - 246 200 UNC	148
HSS		DIN 352			UNF	800 N/mm²	Nr. 2 - 1 1/2"	246 020 UNF - 246 112 UNF	149
HSS		DIN 352	B		M	800 N/mm²	M 3 - M 12	231 030 - 231 120	152
HSSE Co 5		DIN 352	B		M	1000 N/mm²	M 3 - M 12	231 030 E - 231 120 E	152
HSS			C		NPT	800 N/mm²	1/16 - 2"	231 116 NPT - 231 020 NPT	153
HSS		DIN 5157	B		G (BSP)	800 N/mm²	G 1/8 - G 1"	236 210 - 236 238	154



HSS		DIN 22568	B		M	800 N/mm²	M 2 - M 52	237 020 - 237 520	143
HSS		DIN 22568	B		M	800 N/mm²	M 3 - M 12	238 030 - 238 120	143
HSS		DIN 22568	B		M	800 N/mm²	M 3 - M 20	237 030 Li - 230 200 Li	143
HSSE Co 5		DIN 22568	B		M	1000 N/mm²	M 2 - M 24	237 020 E - 237 240 E	143
HSS		DIN 22568	B		MF	800 N/mm²	MF 3 - MF 52	239 030 - 239 520	145
HSS		DIN 24231	B		G (BSP)	800 N/mm²	G 1/8 - G 2"	240 018 - 240 020	146
HSS		DIN 22568	B		Ww (BSW)	800 N/mm²	1/16 - 2"	247 116 - 247 020	147
HSS		DIN 22568	B		UNC	800 N/mm²	Nr. 2 - 2"	240 020 UNC - 240 112 UNC	148
HSS		DIN 22568	B		UNF	800 N/mm²	Nr. 2 - 1 1/2"	240 020 UNF - 240 112 UNF	149
HSS		DIN 382			M	800 N/mm²	M 3 - M 30	267 030 - 267 300	153
HSS		DIN 382	B		G (BSP)	800 N/mm²	G 1/8 - G 1"	267 610 - 267 638	154

Stahl (N/mm ²) < 800	Stahl (N/mm ²) < 1000	Stahl (N/mm ²) < 1200	rostfreier Stahl	Aluminium	Messing	Bronze	Kunststoffe	Gusseisen	Titan legiert
■				■	■	□	■	□	
■				■	■	□	■	□	
■	■		■	■	■	■	■	□	
■				■	■	□	■	□	
■				■	■	□	■	□	
■				■	■	□	■	□	
■				■	■	□	■	□	
■				■	■	□	■	□	
■				■	■	□	■	□	
■				■	■	■	■	□	
■				■	■	□	■	□	

■				■	■	□	■	□	
■				■	■	□	■	□	
■				■	■	□	■	□	
■	■		■	■	■	■	■	□	
■				■	■	□	■	□	
■				■	■	□	■	□	
■				■	■	□	■	□	
■				■	■	□	■	□	
■				■	■	□	■	□	
■				■	■	□	■	□	
■				■	■	□	■	□	



Handgewindebohrer M DIN 352 HSS, HSS-Linksgewinde und HSSE-Co 5, geschliffen

Satz: 3-teilig
 Vorschneider: ca. 6 - 8 Gang Anschnitt
 Mittelschneider: ca. 4 - 5 Gang Anschnitt
 Fertigschneider: ca. 2 - 3 Gang Anschnitt
 Gewinde: metrisch DIN ISO 13
 Flanken: hinterschliffen

Auch einzeln lieferbar
 Vorschneider: Artikel-Nr. 230-1
 Mittelschneider: Artikel-Nr. 230-2
 Fertigschneider: Artikel-Nr. 230-3

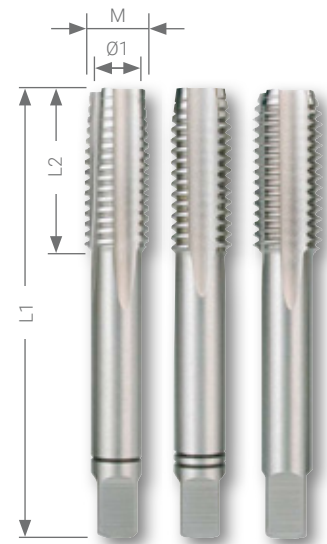

Verpackungseinheit: Satz in Kunststoffverpackung

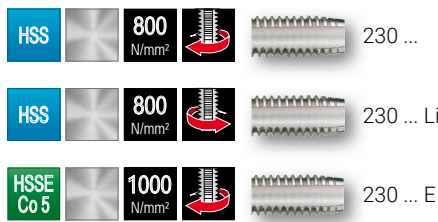

Stahl (N/mm ²) < 800	■	■	■
Stahl (N/mm ²) < 1000			■
rostfreier Stahl			■
Aluminium	■	■	■

Messing	■	■	■
Bronze	□	□	■
Kunststoffe	■	■	■
Gusseisen	□	□	□
Titan legiert			

Nennmaß M	Steigung mm	Kernloch Ø1 mm	L1 mm	L2 mm				
M 2	0,40	1,60	36,0	8,0	230 020	—	230 020 E	1
M 2,5	0,45	2,10	40,0	8,0	230 025	—	—	1
M 3	0,50	2,50	40,0	10,0	230 030	230 030 Li	230 030 E	1
M 3,5	0,60	2,90	45,0	12,0	230 035	—	—	1
M 4	0,70	3,30	45,0	12,0	230 040	230 040 Li	230 040 E	1
M 4,5	0,75	3,70	50,0	16,0	230 045	—	—	1
M 5	0,80	4,20	50,0	13,0	230 050	230 050 Li	230 050 E	1
M 6	1,00	5,00	56,0	15,0	230 060	230 060 Li	230 060 E	1
M 7	1,00	6,00	56,0	16,0	230 070	—	—	1
M 8	1,25	6,80	56,0	18,0	230 080	230 080 Li	230 080 E	1
M 9	1,25	7,80	63,0	22,0	230 090	—	—	1
M 10	1,50	8,50	70,0	24,0	230 100	230 100 Li	230 100 E	1
M 11	1,50	9,50	70,0	24,0	230 110	—	—	1
M 12	1,75	10,20	75,0	29,0	230 120	230 120 Li	230 120 E	1
M 14	2,00	12,00	80,0	30,0	230 140	230 140 Li	230 140 E	1
M 15	2,00	13,00	80,0	32,0	230 150	—	—	1
M 16	2,00	14,00	80,0	32,0	230 160	230 160 Li	230 160 E	1
M 18	2,50	15,50	95,0	40,0	230 180	230 180 Li	230 180 E	1
M 20	2,50	17,50	95,0	40,0	230 200	230 200 Li	230 200 E	1
M 22	2,50	19,50	100,0	40,0	230 220	—	230 220 E	1
M 24	3,00	21,00	110,0	45,0	230 240	—	230 240 E	1
M 27	3,00	24,00	110,0	50,0	230 270	—	—	1
M 30	3,50	26,50	125,0	56,0	230 300	—	—	1
M 33	3,50	29,50	125,0	56,0	230 330	—	—	1
M 36	4,00	32,00	150,0	63,0	230 360	—	—	1
M 39	4,00	35,00	150,0	63,0	230 390	—	—	1
M 42	4,50	37,50	150,0	63,0	230 420	—	—	1
M 45	4,50	40,50	160,0	70,0	230 450	—	—	1
M 48	5,00	43,00	180,0	75,0	230 480	—	—	1
M 52	5,00	47,00	180,0	75,0	230 520	—	—	1

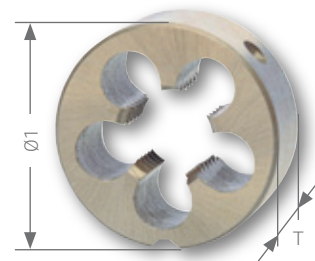

Schneideisen M DIN EN 22568 HSS, HSS-Linksgewinde und HSSE-Co 5, geschliffen

Typ: Form B geschlossen, vorgeschlitzt
 Gewinde: metrisch DIN ISO 13

Verpackungseinheit: einzeln in Kunststoffverpackung

				237 ... 238 ...
				237 ... Li
				237 ... E

Stahl (N/mm²) < 800	■	■	■
Stahl (N/mm²) < 1000			■
rostfreier Stahl			■
Aluminium	■	■	■

Messing	■	■	■
Bronze	□	□	■
Kunststoffe	■	■	■
Gusseisen	□	□	□
Titan legiert			

Nennmaß M	Steigung mm	Außen Ø1 mm	Dicke T mm					
M 2	0,40	16,0	5,0	237 020	—	—	237 020 E	1
M 2,5	0,45	16,0	5,0	237 025	—	—	—	1
M 3	0,50	20,0	5,0	237 030	—	237 030 Li	237 030 E	1
M 3	0,50	25,0	9,0	—	238 030	—	—	1
M 3,5	0,60	20,0	5,0	237 035	—	—	—	1
M 4	0,70	20,0	5,0	237 040	—	237 040 Li	237 040 E	1
M 4	0,70	25,0	9,0	—	238 040	—	—	1
M 4,5	0,75	20,0	7,0	237 045	—	—	—	1
M 5	0,80	20,0	7,0	237 050	—	237 050 Li	237 050 E	1
M 5	0,80	25,0	9,0	—	238 050	—	—	1
M 6	1,00	20,0	7,0	237 060	—	237 060 Li	237 060 E	1
M 6	1,00	25,0	9,0	—	238 060	—	—	1
M 7	1,00	25,0	9,0	237 070	—	237 070 Li	—	1
M 8	1,25	25,0	9,0	237 080	238 080	237 080 Li	237 080 E	1
M 9	1,25	25,0	9,0	237 090	—	—	—	1
M 10	1,50	30,0	11,0	237 100	—	237 100 Li	237 100 E	1
M 10	1,50	25,0	9,0	—	238 100	—	—	1
M 11	1,50	30,0	11,0	237 110	—	—	—	1
M 12	1,75	38,0	14,0	237 120	—	237 120 Li	237 120 E	1
M 12	1,75	25,0	9,0	—	238 120	—	—	1
M 14	2,00	38,0	14,0	237 140	—	237 140 Li	237 140 E	1
M 16	2,00	45,0	18,0	237 160	—	237 160 Li	237 160 E	1
M 18	2,50	45,0	18,0	237 180	—	237 180 Li	237 180 E	1
M 20	2,50	45,0	18,0	237 200	—	237 200 Li	237 200 E	1
M 22	2,50	55,0	22,0	237 220	—	—	237 220 E	1
M 24	3,00	55,0	22,0	237 240	—	—	237 240 E	1
M 27	3,00	65,0	25,0	237 270	—	—	—	1
M 30	3,50	65,0	25,0	237 300	—	—	—	1
M 33	3,50	65,0	25,0	237 330	—	—	—	1
M 36	4,00	65,0	25,0	237 360	—	—	—	1
M 39	4,00	75,0	30,0	237 390	—	—	—	1
M 42	4,50	75,0	30,0	237 420	—	—	—	1
M 45	4,50	90,0	36,0	237 450	—	—	—	1
M 48	5,00	90,0	36,0	237 480	—	—	—	1
M 52	5,00	90,0	36,0	237 520	—	—	—	1

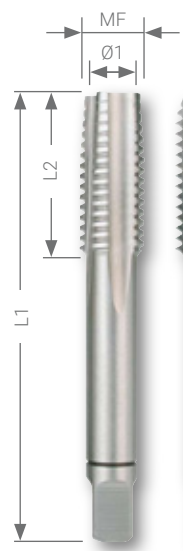

Handgewindebohrer MF DIN 2181 HSS, geschliffen

Satz: 2-teilig
 Vorschneider: ca. 5 - 6 Gang Anschnitt
 Fertigschneider: ca. 2 - 3 Gang Anschnitt
 Gewinde: metrisch fein DIN ISO 13
 Flanken: hinterschliffen

Nach zwei Umdrehungen der Bohrer 1/3 Umdrehung zurückdrehen, um den Span zu brechen. So sinkt die Belastung auf den Gewindebohrer. Schmierung mit RUKO Schneidöl ist zu empfehlen.

Verpackungseinheit: Satz in Kunststoffverpackung

Stahl (N/mm2) < 800	■	Messing	■
Stahl (N/mm2) < 1000		Bronze	□
		Kunststoffe	■
rostfreier Stahl		Gusseisen	□
Aluminium	■	Titan legiert	

Auch einzeln lieferbar
 Vorschneider: Artikel-Nr. 235-1
 Fertigschneider: Artikel-Nr. 235-2

Nennmaß MF	Steigung mm	Kernloch Ø1 mm	L1 mm	L2 mm	HSS	
MF 3	0,35	2,60	40,0	10,0	235 030	1
MF 4	0,35	3,10	45,0	10,0	235 040	1
MF 4	0,50	3,50	45,0	12,0	235 041	1
MF 5	0,50	4,50	50,0	13,0	235 050	1
MF 5	0,75	4,25	50,0	13,0	235 051	1
MF 6	0,50	5,50	50,0	14,0	235 061	1
MF 6	0,75	5,20	50,0	15,0	235 060	1
MF 7	0,75	6,20	50,0	14,0	235 070	1
MF 8	0,50	7,50	50,0	19,0	235 082	1
MF 8	0,75	7,20	56,0	18,0	235 080	1
MF 8	1,00	7,00	56,0	18,0	235 081	1
MF 9	0,75	8,20	56,0	19,0	235 092	1
MF 9	1,00	8,00	63,0	20,0	235 090	1
MF 10	0,75	9,20	63,0	20,0	235 102	1
MF 10	1,00	9,00	63,0	18,0	235 100	1
MF 10	1,25	8,70	70,0	24,0	235 101	1
MF 11	1,00	9,20	63,0	20,0	235 110	1
MF 11	1,25	9,80	63,0	22,0	235 111	1
MF 12	1,00	11,00	70,0	20,0	235 122	1
MF 12	1,25	10,70	70,0	20,0	235 121	1
MF 12	1,50	10,50	70,0	20,0	235 120	1
MF 13	1,00	12,00	70,0	22,0	235 130	1
MF 13	1,50	11,50	70,0	22,0	235 131	1
MF 14	1,00	13,00	70,0	20,0	235 142	1
MF 14	1,25	12,70	70,0	20,0	235 140	1
MF 14	1,50	12,50	70,0	20,0	235 141	1
MF 15	1,50	13,50	70,0	22,0	235 150	1
MF 16	1,00	15,00	70,0	20,0	235 161	1
MF 16	1,25	14,75	70,0	20,0	235 162	1
MF 16	1,50	14,50	70,0	20,0	235 160	1
MF 18	1,00	17,00	80,0	22,0	235 181	1
MF 18	1,25	16,80	80,0	22,0	235 183	1

Nennmaß MF	Steigung mm	Kernloch Ø1 mm	L1 mm	L2 mm	HSS	
MF 18	1,50	16,50	80,0	22,0	235 180	1
MF 18	2,00	16,00	80,0	22,0	235 182	1
MF 20	1,00	19,00	80,0	22,0	235 201	1
MF 20	1,25	18,80	80,0	22,0	235 203	1
MF 20	1,50	18,50	80,0	22,0	235 200	1
MF 20	2,00	18,00	80,0	22,0	235 202	1
MF 22	1,00	21,00	80,0	22,0	235 221	1
MF 22	1,50	20,50	80,0	22,0	235 220	1
MF 22	2,00	20,00	80,0	22,0	235 222	1
MF 24	1,00	23,00	90,0	22,0	235 242	1
MF 24	1,50	22,50	90,0	22,0	235 240	1
MF 24	2,00	22,00	90,0	22,0	235 241	1
MF 25	1,50	23,50	90,0	22,0	235 250	1
MF 26	1,50	24,50	90,0	22,0	235 261	1
MF 26	2,00	24,00	90,0	22,0	235 260	1
MF 27	1,50	25,50	90,0	22,0	235 270	1
MF 27	2,00	25,00	90,0	22,0	235 271	1
MF 28	1,50	26,50	90,0	22,0	235 280	1
MF 28	2,00	26,00	90,0	22,0	235 281	1
MF 30	1,00	29,00	90,0	22,0	235 300	1
MF 30	1,50	28,50	90,0	22,0	235 301	1
MF 30	2,00	28,00	90,0	22,0	235 302	1
MF 32	1,50	30,50	90,0	22,0	235 320	1
MF 35	1,50	33,50	100,0	25,0	235 350	1
MF 38	1,50	36,50	110,0	25,0	235 380	1
MF 40	1,50	38,50	110,0	25,0	235 400	1
MF 42	1,50	40,50	110,0	25,0	235 420	1
MF 45	1,50	43,50	110,0	25,0	235 450	1
MF 48	1,50	46,50	125,0	40,0	235 480	1
MF 50	1,50	48,50	125,0	40,0	235 500	1
MF 52	1,50	50,50	125,0	40,0	235 520	1

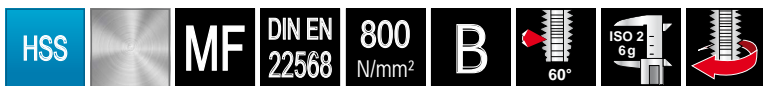

Schneideisen MF DIN EN 22568 HSS, geschliffen

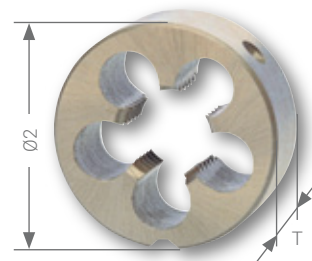

Typ: Form B geschlossen, vorgeschlitzt
 Gewinde: metrisch fein DIN ISO 13



 Es empfiehlt sich das Schneideisen zwischendurch kurz zurückzudrehen, damit die Späne brechen und die Gewindegänge nicht verstopfen. Schmierung mit RUKO Schneidöl ist zu empfehlen.

Verpackungseinheit: einzeln in Kunststoffverpackung

			
Stahl (N/mm ²) < 800	■	Messing	■
Stahl (N/mm ²) < 1000		Bronze	□
		Kunststoffe	■
rostfreier Stahl		Gusseisen	□
Aluminium	■	Titan legiert	

Nennmaß MF	Steigung mm	Außen Ø2 mm	Dicke T mm	HSS		Nennmaß MF	Steigung mm	Außen Ø2 mm	Dicke T mm	HSS	
MF 3	0,35	20,0	5,0	239 030	1	MF 18	1,50	45,0	14,0	239 180	1
MF 4	0,35	20,0	5,0	239 040	1	MF 18	2,00	45,0	14,0	239 182	1
MF 4	0,50	20,0	5,0	239 041	1	MF 20	1,00	45,0	14,0	239 201	1
MF 5	0,50	20,0	5,0	239 050	1	MF 20	1,25	45,0	14,0	239 203	1
MF 5	0,75	20,0	7,0	239 051	1	MF 20	1,50	45,0	14,0	239 200	1
MF 6	0,50	20,0	5,0	239 061	1	MF 20	2,00	45,0	14,0	239 202	1
MF 6	0,75	20,0	7,0	239 060	1	MF 22	1,00	55,0	16,0	239 221	1
MF 7	0,75	25,0	9,0	239 070	1	MF 22	1,50	55,0	16,0	239 220	1
MF 8	0,50	25,0	9,0	239 082	1	MF 22	2,00	55,0	16,0	239 222	1
MF 8	0,75	25,0	9,0	239 080	1	MF 24	1,00	55,0	16,0	239 242	1
MF 8	1,00	25,0	9,0	239 081	1	MF 24	1,50	55,0	16,0	239 240	1
MF 9	0,75	25,0	9,0	239 090	1	MF 24	2,00	55,0	16,0	239 241	1
MF 9	1,00	25,0	9,0	239 091	1	MF 25	1,50	55,0	16,0	239 250	1
MF 10	0,75	30,0	11,0	239 102	1	MF 26	1,50	55,0	16,0	239 261	1
MF 10	1,00	30,0	11,0	239 100	1	MF 26	2,00	55,0	16,0	239 262	1
MF 10	1,25	30,0	11,0	239 101	1	MF 27	1,50	65,0	18,0	239 270	1
MF 11	1,00	30,0	11,0	239 110	1	MF 27	2,00	65,0	18,0	239 271	1
MF 11	1,25	30,0	11,0	239 111	1	MF 28	1,50	65,0	18,0	239 281	1
MF 12	1,00	38,0	10,0	239 121	1	MF 28	2,00	65,0	18,0	239 282	1
MF 12	1,25	38,0	10,0	239 122	1	MF 30	1,00	65,0	18,0	239 300	1
MF 12	1,50	38,0	10,0	239 120	1	MF 30	1,50	65,0	18,0	239 301	1
MF 13	1,00	38,0	10,0	239 131	1	MF 30	2,00	65,0	18,0	239 302	1
MF 13	1,50	38,0	10,0	239 130	1	MF 32	1,50	65,0	18,0	239 320	1
MF 14	1,00	38,0	10,0	239 142	1	MF 35	1,50	65,0	18,0	239 350	1
MF 14	1,25	38,0	10,0	239 140	1	MF 38	1,50	75,0	20,0	239 380	1
MF 14	1,50	38,0	10,0	239 141	1	MF 40	1,50	75,0	20,0	239 400	1
MF 15	1,50	38,0	10,0	239 150	1	MF 42	1,50	75,0	20,0	239 420	1
MF 16	1,00	45,0	14,0	239 161	1	MF 45	1,50	90,0	22,0	239 450	1
MF 16	1,25	45,0	14,0	239 162	1	MF 48	1,50	90,0	22,0	239 480	1
MF 16	1,50	45,0	14,0	239 160	1	MF 50	1,50	90,0	22,0	239 500	1
MF 18	1,00	45,0	14,0	239 181	1	MF 52	1,50	90,0	22,0	239 520	1
MF 18	1,25	45,0	14,0	239 183	1						



Handgewindebohrer G DIN 5157 HSS, geschliffen

Satz: 2-teilig
 Vorschneider: ca. 5 - 6 Gang Anschnitt
 Fertigschneider: ca. 2 - 3 Gang Anschnitt
 Gewinde: DIN ISO 228 "G" (zyl. Rohrgewinde)
 DIN 2999 "Rp" (Whitworth Rohrgewinde)
 Flanken: hinterschliften

Verpackungseinheit: einzeln in Kunststoffverpackung

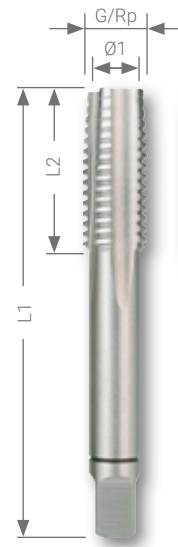

Stahl (N/mm²) < 800	■	Messing	■
Stahl (N/mm²) < 1000		Bronze	□
		Kunststoffe	■
rostfreier Stahl		Gusseisen	□
Aluminium	■	Titan legiert	

Auch einzeln lieferbar
 Vorschneider: Artikel-Nr. 236 ...-1
 Fertigschneider: Artikel-Nr. 236 ...-2

Nennmaß G / Rp		Gangzahl pro Zoll	Kernloch Ø1 mm	L1 mm	L2 mm	HSS	
G 1/8	Rp 1/8	28	8,80	63,0	18,0	236 018	1
G 1/4	Rp 1/4	19	11,80	70,0	20,0	236 014	1
G 3/8	Rp 3/8	19	15,25	70,0	20,0	236 038	1
G 1/2	Rp 1/2	14	19,00	80,0	22,0	236 012	1
G 5/8	Rp 5/8	14	21,00	80,0	22,0	236 058	1
G 3/4	Rp 3/4	14	24,50	90,0	22,0	236 034	1
G 7/8	Rp 7/8	14	28,25	90,0	22,0	236 078	1
G 1"	Rp 1"	11	30,75	100,0	25,0	236 010	1
G 1 1/8	Rp 1 1/8	11	35,30	125,0	40,0	236 118	1
G 1 1/4	Rp 1 1/4	11	39,25	125,0	40,0	236 114	1
G 1 3/8	Rp 1 3/8	11	41,70	140,0	40,0	236 138	1
G 1 1/2	Rp 1 1/2	11	45,25	140,0	40,0	236 112	1
G 1 3/4	Rp 1 3/4	11	51,10	140,0	40,0	236 134	1
G 2"	Rp 2"	11	57,00	160,0	40,0	236 020	1



Schneideisen G DIN EN 24231 HSS, geschliffen

Typ: Form B geschlossen, vorgeschlitzt
 Gewinde: DIN ISO 228 "G" (zylindrisches Rohrgewinde)

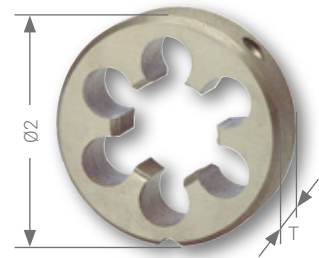

Verpackungseinheit: einzeln in Kunststoffverpackung

Nennmaß G	Gangzahl pro Zoll	Außen Ø2 mm	Dicke T mm	HSS	
G 1/8	28	30,0	11,0	240 018	1
G 1/4	19	38,0	10,0	240 014	1
G 3/8	19	45,0	14,0	240 038	1
G 1/2	14	45,0	14,0	240 012	1
G 5/8	14	55,0	16,0	240 058	1
G 3/4	14	55,0	16,0	240 034	1
G 7/8	14	65,0	18,0	240 078	1
G 1"	11	65,0	18,0	240 010	1

Nennmaß G	Gangzahl pro Zoll	Außen Ø2 mm	Dicke T mm	HSS	
G 1 1/8	11	75,0	20,0	240 118	1
G 1 1/4	11	75,0	20,0	240 114	1
G 1 3/8	11	90,0	22,0	240 138	1
G 1 1/2	11	90,0	22,0	240 112	1
G 1 5/8	11	90,0	22,0	240 158	1
G 1 3/4	11	105,0	22,0	240 134	1
G 2"	11	105,0	22,0	240 020	1



Handgewindebohrer BSW ≈ DIN 352 HSS, geschliffen

Satz: 3-teilig
 Vorschneider: ca. 5 - 6 Gang Anschnitt
 Mittelschneider: ca. 4 - 5 Gang Anschnitt
 Fertigschneider: ca. 2 - 3 Gang Anschnitt
 Gewinde: Whitworth BSW, früher DIN 11
 Flanken: hinterschliften

Verpackungseinheit: Satz in Kunststoffverpackung

Stahl (N/mm²) < 800	■	Messing	■
Stahl (N/mm²) < 1000		Bronze	□
		Kunststoffe	■
rostfreier Stahl		Gusseisen	□
Aluminium	■	Titan legiert	

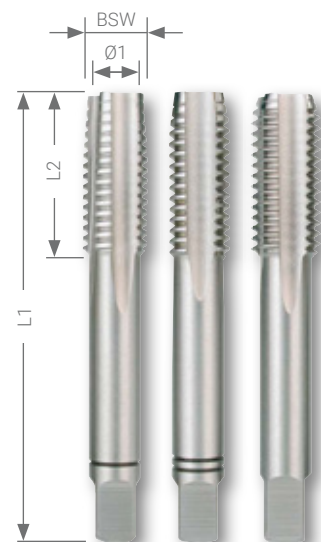

Auch einzeln lieferbar
 Vorschneider: Artikel-Nr. 246-1
 Mittelschneider: Artikel-Nr. 246-2
 Fertigschneider: Artikel-Nr. 246-3

Nennmaß BSW	Gangzahl pro Zoll	Kernloch Ø1 mm	L1 mm	L2 mm	HSS	
1/16	60	1,15	32,0	7,0	246 116	1
3/32	48	1,80	40,0	8,0	246 332	1
1/8	40	2,50	40,0	10,0	246 018	1
5/32	32	3,10	45,0	12,0	246 532	1
3/16	24	3,60	50,0	13,0	246 316	1
7/32	24	4,40	50,0	15,0	246 732	1
1/4	20	5,10	50,0	16,0	246 014	1
5/16	18	6,50	56,0	18,0	246 516	1
3/8	16	7,90	70,0	24,0	246 038	1
7/16	14	9,30	70,0	24,0	246 716	1
1/2	12	10,50	80,0	30,0	246 012	1
9/16	12	12,00	80,0	30,0	246 916	1

Nennmaß BSW	Gangzahl pro Zoll	Kernloch Ø1 mm	L1 mm	L2 mm	HSS	
5/8	11	13,50	80,0	32,0	246 058	1
3/4	10	16,50	95,0	40,0	246 034	1
7/8	9	19,25	100,0	40,0	246 078	1
1"	8	22,00	110,0	50,0	246 010	1
1 1/8	7	24,75	125,0	50,0	246 118	1
1 1/4	7	27,75	125,0	50,0	246 114	1
1 3/8	6	30,20	150,0	63,0	246 138	1
1 1/2	6	33,50	150,0	63,0	246 112	1
1 5/8	5	35,50	150,0	63,0	246 158	1
1 3/4	5	38,50	160,0	70,0	246 134	1
1 7/8	4 1/2	41,50	180,0	75,0	246 178	1
2"	4 1/2	44,50	180,0	75,0	246 020	1



Schneideisen BSW ≈ DIN EN 22568 HSS, geschliffen

Typ: Form B geschlossen, vorgeschlitzt
 Gewinde: Whitworth BSW, früher DIN 11

Verpackungseinheit: einzeln in Kunststoffverpackung

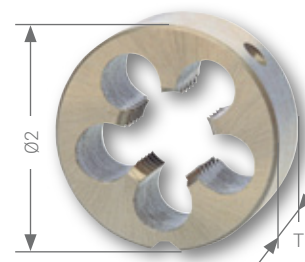

Nennmaß BSW	Gangzahl pro Zoll	Außen Ø2 mm	Dicke T mm	HSS	
1/16	60	16,0	5,0	247 116	1
3/32	48	16,0	5,0	247 332	1
1/8	40	20,0	5,0	247 018	1
5/32	32	20,0	5,0	247 532	1
3/16	24	20,0	7,0	247 316	1
7/32	24	20,0	7,0	247 732	1
1/4	20	25,0	9,0	247 014	1
5/16	18	25,0	9,0	247 516	1
3/8	16	30,0	11,0	247 038	1
7/16	14	30,0	11,0	247 716	1
1/2	12	38,0	14,0	247 012	1
9/16	12	38,0	14,0	247 916	1

Nennmaß BSW	Gangzahl pro Zoll	Außen Ø2 mm	Dicke T mm	HSS	
5/8	11	45,0	18,0	247 058	1
3/4	10	45,0	18,0	247 034	1
7/8	9	55,0	22,0	247 078	1
1"	8	55,0	22,0	247 010	1
1 1/8	7	65,0	25,0	247 118	1
1 1/4	7	65,0	25,0	247 114	1
1 3/8	6	65,0	25,0	247 138	1
1 1/2	6	75,0	30,0	247 112	1
1 5/8	5	75,0	30,0	247 158	1
1 3/4	5	90,0	36,0	247 134	1
1 7/8	4 1/2	90,0	36,0	247 178	1
2"	4 1/2	90,0	36,0	247 020	1



Handgewindebohrer UNC ≈ DIN 352 HSS, geschliffen

Satz: 3-teilig
 Vorschneider: ca. 5 - 6 Gang Anschnitt
 Mittelschneider: ca. 4 - 5 Gang Anschnitt
 Fertigschneider: ca. 2 - 3 Gang Anschnitt
 Gewinde: amerikanisches Grobgewinde UNC
 Flanken: hinterschliften

Verpackungseinheit: Satz in Kunststoffverpackung

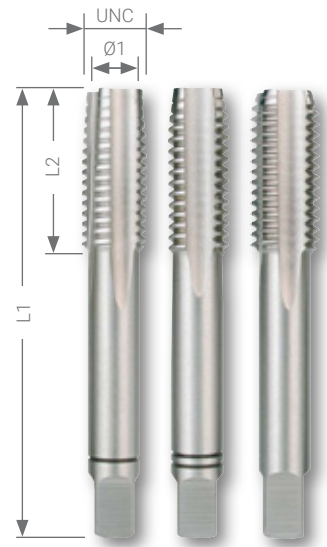

Auch einzeln lieferbar

Vorschneider: Artikel-Nr. 246 UNC1
 Mittelschneider: Artikel-Nr. 246 UNC2
 Fertigschneider: Artikel-Nr. 246 UNC3

Stahl (N/mm²) < 800	■	Messing	■
Stahl (N/mm²) < 1000		Bronze	□
		Kunststoffe	■
rostfreier Stahl		Gusseisen	□
Aluminium	■	Titan legiert	

Nennmaß UNC	Gangzahl pro Zoll	Kernloch Ø1 mm	L1 mm	L2 mm	HSS	
Nr. 2	56	1,8	36,0	11,0	246 020 UNC	1
Nr. 3	48	2,1	36,0	11,0	246 030 UNC	1
Nr. 4	40	2,3	40,0	12,0	246 040 UNC	1
Nr. 5	40	2,6	40,0	12,0	246 050 UNC	1
Nr. 6	32	2,8	45,0	14,0	246 060 UNC	1
Nr. 8	32	3,5	45,0	14,0	246 080 UNC	1
Nr. 10	24	3,9	50,0	16,0	246 100 UNC	1
Nr. 12	24	4,5	50,0	18,0	246 120 UNC	1
1/4	20	5,1	50,0	19,0	246 014 UNC	1
5/16	18	6,6	56,0	22,0	246 516 UNC	1
3/8	16	8,0	70,0	24,0	246 038 UNC	1
7/16	14	9,4	70,0	24,0	246 716 UNC	1

Nennmaß UNC	Gangzahl pro Zoll	Kernloch Ø1 mm	L1 mm	L2 mm	HSS	
1/2	13	10,8	75,0	29,0	246 012 UNC	1
9/16	12	12,2	80,0	30,0	246 916 UNC	1
5/8	11	13,5	80,0	32,0	246 058 UNC	1
3/4	10	16,5	95,0	40,0	246 034 UNC	1
7/8	9	19,5	100,0	40,0	246 078 UNC	1
1"	8	22,2	110,0	50,0	246 010 UNC	1
1 1/8	7	25,0	132,0	56,0	246 118 UNC	1
1 1/4	7	28,0	132,0	56,0	246 114 UNC	1
1 3/8	6	30,7	150,0	63,0	246 138 UNC	1
1 1/2	6	34,0	150,0	63,0	246 112 UNC	1
1 3/4	5	39,5	160,0	70,0	246 134 UNC	1
2"	4 1/2	45,0	190,0	80,0	246 200 UNC	1

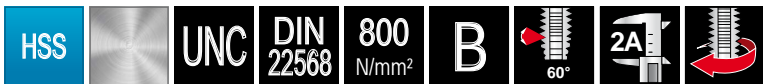

Schneideisen UNC ≈ DIN EN 22568 HSS, geschliffen

Typ: Form B geschlossen, vorgeschlitzt
 Gewinde: amerikanisches Grobgewinde UNC

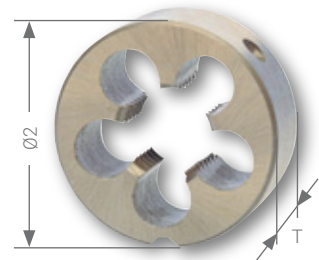

Verpackungseinheit: einzeln in Kunststoffverpackung

Nennmaß UNC	Gangzahl pro Zoll	Außen Ø2 mm	Dicke T mm	HSS	
Nr. 2	56	16,0	5,0	240 020 UNC	1
Nr. 3	48	16,0	5,0	240 030 UNC	1
Nr. 4	40	20,0	5,0	240 040 UNC	1
Nr. 5	40	20,0	5,0	240 050 UNC	1
Nr. 6	32	20,0	7,0	240 060 UNC	1
Nr. 8	32	20,0	7,0	240 080 UNC	1
Nr. 10	24	20,0	7,0	240 100 UNC	1
Nr. 12	24	20,0	7,0	240 120 UNC	1
1/4	20	20,0	7,0	240 014 UNC	1
5/16	18	25,0	9,0	240 516 UNC	1
3/8	16	30,0	11,0	240 038 UNC	1
7/16	14	30,0	11,0	240 716 UNC	1

Nennmaß UNC	Gangzahl pro Zoll	Außen Ø2 mm	Dicke T mm	HSS	
1/2	13	38,0	14,0	240 012 UNC	1
9/16	12	38,0	14,0	240 916 UNC	1
5/8	11	45,0	18,0	240 058 UNC	1
3/4	10	45,0	18,0	240 034 UNC	1
7/8	9	55,0	22,0	240 078 UNC	1
1"	8	55,0	22,0	240 010 UNC	1
1 1/8	7	65,0	25,0	240 118 UNC	1
1 1/4	7	65,0	25,0	240 114 UNC	1
1 3/8	6	65,0	25,0	240 138 UNC	1
1 1/2	6	75,0	30,0	240 112 UNC	1
1 3/4	5	90,0	36,0	240 134 UNC	1
2"	4,5	90,0	36,0	240 200 UNC	1

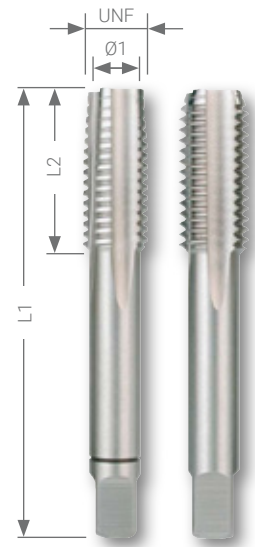

Handgewindebohrer UNF ≈ DIN 2181 HSS, geschliffen

Satz: 2-teilig
 Vorschneider: ca. 5 - 6 Gang Anschnitt
 Fertigschneider: ca. 2 - 3 Gang Anschnitt
 Gewinde: amerikanisches Feingewinde UNF
 Flanken: hinterschliffen

Verpackungseinheit: Satz in Kunststoffverpackung

Stahl (N/mm²) < 800	<input checked="" type="checkbox"/>	Messing	<input checked="" type="checkbox"/>
Stahl (N/mm²) < 1000	<input type="checkbox"/>	Bronze	<input type="checkbox"/>
	<input type="checkbox"/>	Kunststoffe	<input checked="" type="checkbox"/>
rostfreier Stahl	<input type="checkbox"/>	Gusseisen	<input type="checkbox"/>
Aluminium	<input checked="" type="checkbox"/>	Titan legiert	<input type="checkbox"/>

Auch einzeln lieferbar
 Vorschneider: Artikel-Nr. 246 UNF1
 Fertigschneider: Artikel-Nr. 246 UNF2

Nennmaß UNF	Gangzahl pro Zoll	Kernloch Ø1 mm	L1 mm	L2 mm	HSS	
Nr. 2	64	1,85	32,0	10,0	246 020 UNF	1
Nr. 3	56	2,15	32,0	10,0	246 030 UNF	1
Nr. 4	48	2,40	36,0	11,0	246 040 UNF	1
Nr. 5	44	2,70	36,0	11,0	246 050 UNF	1
Nr. 6	40	2,95	40,0	12,0	246 060 UNF	1
Nr. 8	36	3,50	40,0	12,0	246 080 UNF	1
Nr. 10	32	4,10	45,0	14,0	246 100 UNF	1
Nr. 12	28	4,60	50,0	14,0	246 120 UNF	1
1/4	28	5,50	50,0	18,0	246 014 UNF	1
5/16	24	6,90	56,0	22,0	246 516 UNF	1
3/8	24	8,50	63,0	22,0	246 038 UNF	1

Nennmaß UNF	Gangzahl pro Zoll	Kernloch Ø1 mm	L1 mm	L2 mm	HSS	
7/16	20	9,90	63,0	22,0	246 716 UNF	1
1/2	20	11,50	75,0	24,0	246 012 UNF	1
9/16	18	12,90	80,0	28,0	246 916 UNF	1
5/8	18	14,50	80,0	28,0	246 058 UNF	1
3/4	16	17,50	95,0	32,0	246 034 UNF	1
7/8	14	20,50	100,0	36,0	246 078 UNF	1
1"	12	23,25	110,0	40,0	246 010 UNF	1
1 1/8	12	22,00	110,0	50,0	246 118 UNF	1
1 1/4	12	22,00	132,0	56,0	246 114 UNF	1
1 3/8	12	28,00	132,0	56,0	246 138 UNF	1
1 1/2	12	32,00	150,0	63,0	246 112 UNF	1



Schneideisen UNF ≈ DIN EN 22568 HSS, geschliffen

Typ: Form B geschlossen, vorgeschlitzt
 Gewinde: amerikanisches Feingewinde UNF

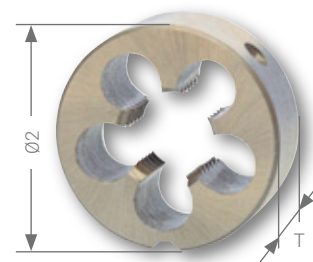

Verpackungseinheit: einzeln in Kunststoffverpackung

Nennmaß UNF	Gangzahl pro Zoll	Außen Ø2 mm	Dicke T mm	HSS	
Nr. 2	64	16,0	5,0	240 020 UNF	1
Nr. 3	56	16,0	5,0	240 030 UNF	1
Nr. 4	48	16,0	5,0	240 040 UNF	1
Nr. 5	44	20,0	5,0	240 050 UNF	1
Nr. 6	40	20,0	5,0	240 060 UNF	1
Nr. 8	36	20,0	7,0	240 080 UNF	1
Nr. 10	32	20,0	7,0	240 100 UNF	1
Nr. 12	28	20,0	7,0	240 120 UNF	1
1/4	28	20,0	7,0	240 014 UNF	1
5/16	24	25,0	9,0	240 516 UNF	1
3/8	24	30,0	11,0	240 038 UNF	1

Nennmaß UNF	Gangzahl pro Zoll	Außen Ø2 mm	Dicke T mm	HSS	
7/16	20	30,0	11,0	240 716 UNF	1
1/2	20	38,0	10,0	240 012 UNF	1
9/16	18	38,0	10,0	240 916 UNF	1
5/8	18	45,0	14,0	240 058 UNF	1
3/4	16	45,0	14,0	240 034 UNF	1
7/8	14	55,0	16,0	240 078 UNF	1
1"	12	55,0	16,0	240 010 UNF	1
1 1/8	12	65,0	18,0	240 118 UNF	1
1 1/4	12	65,0	18,0	240 114 UNF	1
1 3/8	12	65,0	18,0	240 138 UNF	1
1 1/2	12	75,0	20,0	240 112 UNF	1



Handgewindebohrer-Sätze HSS und HSSE-Co 5 in Industriekassette

	HSS	HSSE Co 5
21-teiliger Handgewindebohrer-Satz M DIN 352 je ein 3-tlg. Satz M 3 - M 4 - M 5 - M 6 - M 8 - M 10 - M 12	245 001	245 001 E
22-teiliger Handgewindebohrer-Satz M DIN 352 je ein 3-tlg. Satz M 3 - M 4 - M 5 - M 6 - M 8 - M 10 - M 12 + 1 Windeisen DIN 1814 Gr. 1 1/2	245 002	245 002 E
29-teiliger Handgewindebohrer-Satz M DIN 352 je ein 3-tlg. Satz M 3 - M 4 - M 5 - M 6 - M 8 - M 10 - M 12 + 7 Spiralbohrer DIN 338 Typ N Ø 2,5 - 3,3 - 4,2 - 5,0 - 6,8 - 8,5 - 10,2 mm + 1 Windeisen DIN 1814 Gr. 1 1/2	245 003	245 003 E



Handgewindebohrer-Sätze HSS und HSSE-Co 5 in ABS-Kunststoffkassette

	HSS	HSSE Co 5
21-teiliger Handgewindebohrer-Satz M DIN 352 je ein 3-tlg. Satz M 3 - M 4 - M 5 - M 6 - M 8 - M 10 - M 12	245 001 RO	245 001 ERO
28-teiliger Handgewindebohrer-Satz M DIN 352 je ein 3-tlg. Satz M 3 - M 4 - M 5 - M 6 - M 8 - M 10 - M 12 + 7 Spiralbohrer DIN 338 Typ N Ø 2,5 - 3,3 - 4,2 - 5,0 - 6,8 - 8,5 - 10,2 mm	245 003 RO	245 003 ERO



Gewindeschneidwerkzeug-Sätze HSS und HSSE-Co 5 in Industriekassette

	HSS	HSSE Co 5
31-teiliger Gewindeschneidwerkzeug Hobbysatz je ein 3-teiliger Satz Handgewindebohrer M DIN 352 M 3 - M 4 - M 5 - M 6 - M 8 - M 10 - M 12 + 7 Schneideisen Ø 25,0 mm ≈ DIN EN 22568 M 3 - M 4 - M 5 - M 6 - M 8 - M 10 - M 12 + 1 Schneideisenhalter DIN 225 25,0 x 9,0 mm + 1 Windeisen DIN 1814 Gr. 1 ½ + 1 Schraubendreher	245 010	245 010 E
37-teiliger Gewindeschneidwerkzeug-Satz je ein 3-teiliger Satz Handgewindebohrer M DIN 352 M 3 - M 4 - M 5 - M 6 - M 8 - M 10 - M 12 + 7 Schneideisen M DIN EN 22568 M 3 - M 4 - M 5 - M 6 - M 8 - M 10 - M 12 + 5 Schneideisenhalter DIN 225 20,0 x 5,0 mm - 20,0 x 7,0 mm - 25,0 x 9,0 mm - 30,0 x 11,0 mm - 38,0 x 14,0 mm + 2 Windeisen DIN 1814 Gr. 1 und Gr. 2 + 1 Schraubendreher + 1 Gewindeschablone	245 020	245 020 E
44-teiliger Gewindeschneidwerkzeug-Satz je ein 3-teiliger Satz Handgewindebohrer M DIN 352 M 3 - M 4 - M 5 - M 6 - M 8 - M 10 - M 12 + 7 Spiralbohrer DIN 338 Typ N Ø 2,5 - 3,3 - 4,2 - 5,0 - 6,8 - 8,5 - 10,2 mm + 7 Schneideisen M DIN EN 22568 M 3 - M 4 - M 5 - M 6 - M 8 - M 10 - M 12 + 5 Schneideisenhalter DIN 225 20,0 x 5,0 mm - 20,0 x 7,0 mm - 25,0 x 9,0 mm - 30,0 x 11,0 mm - 38,0 x 14,0 mm + 2 Windeisen DIN 1814 Gr. 1 und Gr. 2 + 1 Schraubendreher + 1 Gewindeschablone	245 030	245 030 E
54-teiliger Gewindeschneidwerkzeug-Satz je ein 3-teiliger Satz Handgewindebohrer M DIN 352 M 3 - M 4 - M 5 - M 6 - M 8 - M 10 - M 12 - M 14 - M 16 - M 18 - M 20 + 11 Schneideisen M DIN EN 22568 M 3 - M 4 - M 5 - M 6 - M 8 - M 10 - M 12 - M 14 - M 16 - M 18 - M 20 + 6 Schneideisenhalter DIN 225 20,0 x 5,0 mm - 20,0 x 7,0 mm - 25,0 x 9,0 mm - 30,0 x 11,0 mm - 38,0 x 14,0 mm - 45,0 x 18,0 mm + 2 Windeisen DIN 1814 Gr. 1 und Gr. 3 + 1 Schraubendreher + 1 Gewindeschablone	245 040	245 040 E
43-teiliger Gewindeschneidwerkzeug-Satz MF (metrisch fein) je ein 2-teiliger Satz Handgewindebohrer MF DIN 2181 MF 3 x 0,35 - MF 4 x 0,35 - MF 5 x 0,5 - MF 6 x 0,75 - MF 8 x 0,75 - MF 10 x 1,0 - MF 12 x 1,5 - MF 14 x 1,5 - MF 16 x 1,5 - MF 18 x 1,5 - MF 20 x 1,5 mm + 11 Schneideisen MF DIN 22568 MF 3 - MF 4 - MF 5 - MF 6 - MF 8 - MF 10 - MF 12 - MF 14 - MF 16 - MF 18 - MF 20 + 6 Schneideisenhalter DIN 225 20,0 x 5,0 mm - 20,0 x 7,0 mm - 25,0 x 9,0 mm - 30,0 x 11,0 mm - 38,0 x 10,0 mm - 45,0 x 14,0 mm + 2 Windeisen DIN 1814 Gr. 1 und Gr. 3 + 1 Schraubendreher + 1 Gewindeschablone	245 041	—

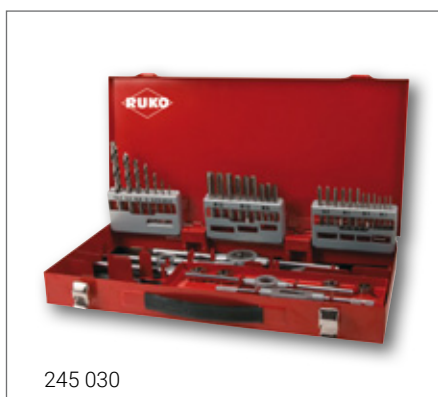



Einschnittgewindebohrer M ≈ DIN 352 HSS und HSSE-Co 5, geschliffen

Gewinde: metrisch DIN ISO 13
Flanken: hinterschliffen

Gewindebohrer HSS für Durchgangsgewinde, in unlegierte und niedriglegierte Stähle bis 800 N/mm² und Gewindebohrer HSSE-Co 5 für Durchgangsgewinde, in unlegierte und legierte Stähle bis 1000 N/mm² Festigkeit, Temperguß und NE-Metalle. Das Gewinde kann von Hand und im Maschinengebrauch in einem Arbeitsgang geschnitten werden.

Verpackungseinheit: einzeln in Kunststoffverpackung

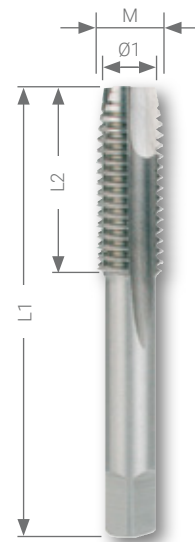

HSS	800 N/mm ²		231 ...		
HSSE Co 5	1000 N/mm ²		231 ... E		

Stahl (N/mm ²) < 800		
Stahl (N/mm ²) < 1000		
rostfreier Stahl		
Aluminium		

Messing		
Bronze		
Kunststoffe		
Gusseisen		
Titan legiert		

Nennmaß M	Steigung mm	Kernloch Ø1 mm	L1 mm	L2 mm	HSS	HSSE Co 5	
M 3	0,50	2,50	40,0	10,0	231 030	231 030 E	1
M 4	0,70	3,30	45,0	12,0	231 040	231 040 E	1
M 5	0,80	4,20	50,0	13,0	231 050	231 050 E	1
M 6	1,00	5,00	50,0	15,0	231 060	231 060 E	1
M 8	1,25	6,80	56,0	18,0	231 080	231 080 E	1
M 9	1,25	7,80	67,0	22,0	231 090	-	1
M 10	1,50	8,50	70,0	24,0	231 100	231 100 E	1
M 12	1,75	10,20	75,0	29,0	231 120	231 120 E	1

Einschnittgewindebohrer-Satz HSS in Industriekassette

	245 004
15-teiliger Einschnittgewindebohrer-Satz 7 Einschnittgewindebohrer M ≈ DIN 352 HSS, M 3 - M 4 - M 5 - M 6 - M 8 - M 10 - M 12 + 7 Spiralbohrer DIN 338 Typ N HSS-G Ø 2,5 - 3,3 - 4,2 - 5,0 - 6,8 - 8,5 - 10,2 mm + 1 Windeisen DIN 1814 Gr. 1 1/2	



Einschnittgewindebohrer-Satz HSS in ABS-Kunststoffkassette

	245 004 RO
15-teiliger Einschnittgewindebohrer-Satz 7 Einschnittgewindebohrer M ≈ DIN 352 HSS, M 3 - M 4 - M 5 - M 6 - M 8 - M 10 - M 12 + 7 Spiralbohrer DIN 338 Typ N HSS-G Ø 2,5 - 3,3 - 4,2 - 5,0 - 6,8 - 8,5 - 10,2 mm + 1 Windeisen DIN 1814 Gr. 1 1/2	





Einschnittgewindebohrer NPT HSS, geschliffen

Gewinde: amerikanisches kegeliges Rohrgewinde nach ANSI B.1.20.1
 Flanken: hinterschliffen
 Kegel: 1:16

Für Durchgangsgewinde, in unlegierte und niedriglegierte Stähle bis 800 N/mm² Festigkeit, Temperguß und NE-Metalle. Das Gewinde kann von Hand und im Maschinengebrauch in einem Arbeitsgang geschnitten werden.

Hinweis: Zylindrisch vorbohren!

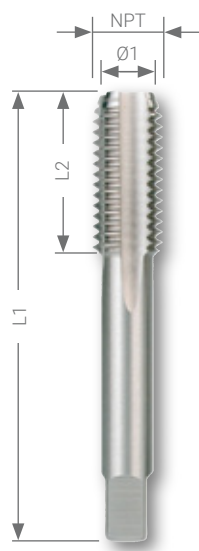

Verpackungseinheit: einzeln in Kunststoffverpackung

Stahl (N/mm ²) < 800	■	Messing	■
Stahl (N/mm ²) < 1000		Bronze	□
		Kunststoffe	■
rostfreier Stahl		Gusseisen	□
Aluminium	■	Titan legiert	

Nennmaß NPT	Gangzahl pro Zoll	Kernloch Ø1 mm	Schnitttiefe in mm	L1 mm	L2 mm	HSS	
1/16	27,0	6,00	12,00	65,0	19,0	231 116 NPT	1
1/8	27,0	8,25	12,00	65,0	19,0	231 018 NPT	1
1/4	18,0	10,70	17,50	70,0	25,0	231 014 NPT	1
3/8	18,0	14,10	17,50	75,0	26,0	231 038 NPT	1
1/2	14,0	17,40	22,90	80,0	31,0	231 012 NPT	1
3/4	14,0	22,60	23,00	100,0	33,0	231 034 NPT	1
1"	11,5	28,50	27,40	110,0	38,0	231 010 NPT	1
1 1/4"	11,5	37,00	28,10	125,0	41,0	231 114 NPT	1
1 1/2"	11,5	43,50	28,40	140,0	42,0	231 112 NPT	1
2"	11,5	55,00	28,40	160,0	44,0	231 020 NPT	1



Sechskant-Schneidmutter M DIN 382 HSS, geschliffen

Gewinde: metrisch DIN ISO 13

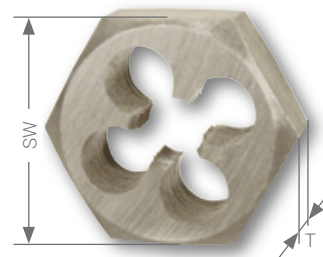

Verpackungseinheit: einzeln in Kunststoffverpackung

Nennmaß M	Steigung mm	Schlüsselweite SW mm	Dicke T mm	HSS	
M 3	0,50	18,0	5,0	267 030	1
M 4	0,70	18,0	5,0	267 040	1
M 5	0,80	18,0	7,0	267 050	1
M 6	1,00	18,0	7,0	267 060	1
M 8	1,25	21,0	9,0	267 080	1
M 10	1,50	27,0	11,0	267 100	1
M 12	1,75	36,0	14,0	267 120	1
M 14	2,00	36,0	14,0	267 140	1

Nennmaß M	Steigung mm	Schlüsselweite SW mm	Dicke T mm	HSS	
M 16	2,00	41,0	18,0	267 160	1
M 18	2,50	41,0	18,0	267 180	1
M 20	2,50	41,0	18,0	267 200	1
M 22	2,50	50,0	22,0	267 220	1
M 24	3,00	50,0	22,0	267 240	1
M 27	3,00	60,0	25,0	267 270	1
M 30	3,50	60,0	25,0	267 300	1



Einschnittgewindebohrer G ≈ DIN 5157 HSS, geschliffen

Gewinde: DIN ISO 228 "G" (zylindrisches Rohrgewinde)
 DIN 2999 "Rp" (Whitworth Rohrgewinde)
 Flanken: hinterschliffen

Verpackungseinheit: einzeln in Kunststoffverpackung

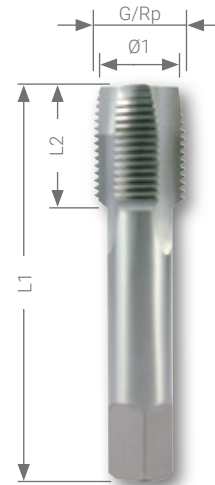

Stahl (N/mm2) < 800	■	Messing	■
Stahl (N/mm2) < 1000		Bronze	□
rostfreier Stahl		Kunststoffe	■
Aluminium	■	Gusseisen	□
		Titan legiert	

Nennmaß G / Rp		Gangzahl pro Zoll	Kernloch Ø1 mm	L1 mm	L2 mm	HSS	
G 1/8	Rp 1/8	28	8,6	63,0	20,0	236 218	1
G 1/4	Rp 1/4	19	11,5	70,0	22,0	236 214	1
G 3/8	Rp 3/8	19	15,0	70,0	22,0	236 238	1
G 1/2	Rp 1/2	14	19,0	80,0	22,0	236 212	1
G 3/4	Rp 3/4	14	24,5	90,0	22,0	236 234	1
G 1"	Rp 1"	11	30,5	100,0	25,0	236 210	1



Sechskant-Schneidmutter G DIN 382 HSS, geschliffen

Gewinde: DIN ISO 228 "G" (zylindrisches Rohrgewinde)

Verpackungseinheit: einzeln in Kunststoffverpackung

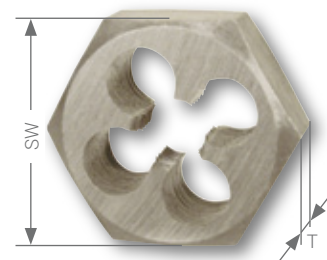

Nennmaß G	Gangzahl pro Zoll	Schlüsselweite SW mm	Dicke T mm	HSS	
G 1/8	28	27,0	11,0	267 618	1
G 1/4	19	36,0	10,0	267 614	1
G 3/8	19	41,0	14,0	267 638	1
G 1/2	14	41,0	14,0	267 612	1
G 3/4	14	50,0	16,0	267 634	1
G 1"	11	60,0	18,0	267 610	1

Sanitär-Reparatur-Gewindeschneidwerkzeug-Satz HSS für zylindrisches Rohrgewinde im Kunststoffkoffer

13-teiliger Sanitär-Reparatur-Gewindeschneidwerkzeug-Satz 6 Einschnittgewindebohrer G/Rp ≈ DIN 5157 HSS geschliffen G/Rp 1/8" x 28 - G/Rp 1/4" x 19 - G/Rp 3/8" x 19 - G/Rp 1/2" x 14 - G/Rp 3/4" x 14 - G/Rp 1" x 11 + 6 Sechskant-Schneidmutter G DIN 382 HSS geschliffen G 1/8" x 28 - G 1/4" x 19 - G 3/8" x 19 - G 1/2" x 14 - G 3/4" x 14 - G 1" x 11 + 1 Schneidpaste 50 g	245 059



Gewindebohrerverlängerung DIN 377

Zur Verlängerung von Handgewindebohrern.
Gleich großer Innen- und Außenvierkant.

Ausführung: gehärtet und geschliffen
Schaft: Vierkant nach DIN 10

Verpackungseinheit: einzeln in Kunststoffverpackung

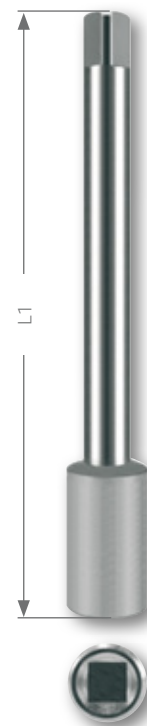

Vierkant mm	Länge mm	für Handgewindebohrer			G		
		M	Ww				
2,1	60,0	M 1 - M 2,6	1/16 - 3/32	—	241 021	1	
2,7	80,0	M 3	—	—	241 027	1	
3,4	95,0	M 4	5/32	—	241 034	1	
4,9	110,0	M 5 - M 8	7/32 - 5/16	—	241 049	1	
5,5	115,0	M 9 - M 10	3/8	1/8	241 055	1	
7,0	125,0	M 12	1/2	—	241 070	1	
9,0	135,0	M 13 - M 16	9/16 - 5/8	1/4	241 090	1	
11,0	150,0	M 18	11/16 - 3/4	—	241 110	1	
12,0	155,0	M 20	13/16	1/2	241 120	1	
14,5	174,0	M 22 - M 24	7/8 - 15/16	5/8	241 145	1	
16,0	185,0	M 27 - M 28	1	3/4	241 160	1	
18,0	195,0	M 30 - M 32	1 1/8	7/8	241 180	1	

Gewindeschneidwerkzeug-Sätze HSS im praktischen Holzkoffer

28-teiliger Gewindeschneidwerkzeug-Satz je ein 2-teiliger Satz Handgewindebohrer G DIN 5157 – 1/8 - 1/4 - 3/8 - 1/2 - 5/8 - 3/4 - 1" + 7 Schneideisen G DIN EN 24231 – 1/8 - 1/4 - 3/8 - 1/2 - 5/8 - 3/4 - 1" + 5 Schneideisenhalter DIN 225 30,0 x 11,0 mm - 38,0 x 10,0 mm - 45,0 x 14,0 mm - 55,0 x 16,0 mm - 65,0 x 18,0 mm + 2 Windeisen DIN 1814 Gr. 3 und Gr. 5	245 074
35-teiliger Gewindeschneidwerkzeug-Satz je ein 2-teiliger Satz Handgewindebohrer UNF ≈ DIN 2181 – 1/4 - 5/16 - 3/8 - 7/16 - 1/2 - 5/8 - 3/4 - 7/8 - 1" + 9 Schneideisen UNF ≈ DIN EN 22568 – 1/4 - 5/16 - 3/8 - 7/16 - 1/2 - 5/8 - 3/4 - 7/8 - 1" + 6 Schneideisenhalter DIN 225 20,0 x 7,0 mm - 25,0 x 9,0 mm - 30,0 x 11,0 mm - 38,0 x 10,0 mm - 45,0 x 14,0 mm - 55,0 x 16,0 mm + 2 Windeisen DIN 1814 Gr. 2 und Gr. 4	245 073
44-teiliger Gewindeschneidwerkzeug-Satz je ein 3-teiliger Satz Handgewindebohrer UNC ≈ DIN 352 – 1/4 - 5/16 - 3/8 - 7/16 - 1/2 - 5/8 - 3/4 - 7/8 - 1" + 9 Schneideisen UNC ≈ DIN EN 22568 – 1/4 - 5/16 - 3/8 - 7/16 - 1/2 - 5/8 - 3/4 - 7/8 - 1" + 6 Schneideisenhalter DIN 225 20,0 x 7,0 mm - 25,0 x 9,0 mm - 30,0 x 11,0 mm - 38,0 x 10,0 mm - 45,0 x 18,0 mm - 55,0 x 22,0 mm + 2 Windeisen DIN 1814 Gr. 2 und Gr. 4	245 072

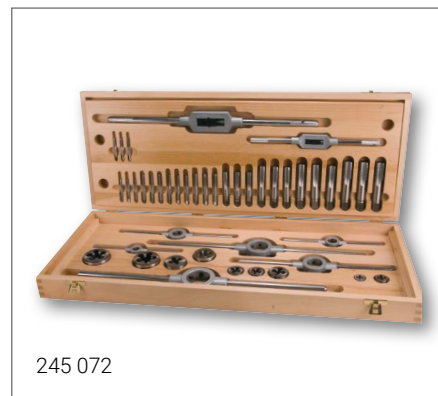
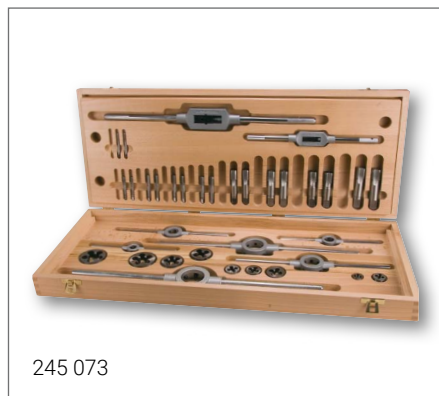
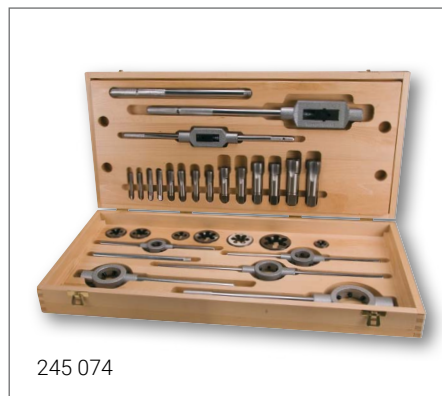

Schneideisen-Halter DIN 225

Zur Aufnahme geschlossener und geschlitzter Schneideisen nach DIN EN 24231.
 Mit Stahlgriffen, davon ein Griff abschraubbar und 5 Schrauben zur Befestigung des Schneideisens.

Ausführung: Gehäuse aus Zinkdruckguß

Verpackungseinheit: einzeln in Kunststoffverpackung

Größe	Dicke mm	L1 mm	für Schneideisen			No.	
			M + MF	Ww	G		
16	5,0	160,0	M 1 - M 2,6	1/16 - 3/32	—	242 165	1
20	5,0	175,0	M 3 - M 4	1/8 - 5/32	—	242 205	1
20	7,0	175,0	M 4,5 - M 6	3/16 - 1/4	—	242 207	1
25	9,0	210,0	M 7 - M 9	5/16	1/16	242 259	1
30	11,0	260,0	M 10 - M 11	3/8 - 7/16	1/8	242 3011	1
38	14,0	310,0	M 12 - M 14	1/2 - 9/16	—	242 3814	1
45	18,0	440,0	M 16 - M 20	5/8 - 3/4	—	242 4518	1
55	22,0	495,0	M 22 - M 24	7/8 - 1	—	242 5522	1
65	25,0	630,0	M 27 - M 36	1 1/8 - 1 3/8	—	242 6525	1
75	30,0	700,0	M 38 - M 42	1 1/2 - 1 5/8	—	242 7530	1
90	36,0	900,0	M 45 - M 52	1 3/4 - 2	—	242 9036	1
105	36,0	930,0	M 54 - M 63	2 1/4 - 2 3/4	—	242 10536	1
38	10,0	310,0	MF 12 - MF 14	—	1/4	242 3810	1
45	14,0	440,0	MF 16 - MF 20	—	3/8 - 1/2	242 4514	1
55	16,0	495,0	MF 22 - MF 24	—	5/8 - 3/4	242 5516	1
65	18,0	630,0	MF 27 - MF 36	—	7/8 - 1	242 6518	1
75	20,0	750,0	MF 38 - MF 42	—	1 1/8 - 1 1/4	242 7520	1
90	22,0	900,0	MF 45 - MF 52	—	1 3/8 - 1 5/8	242 9022	1
105	22,0	930,0	MF 54 - MF 63	—	1 3/4 - 2	242 10522	1

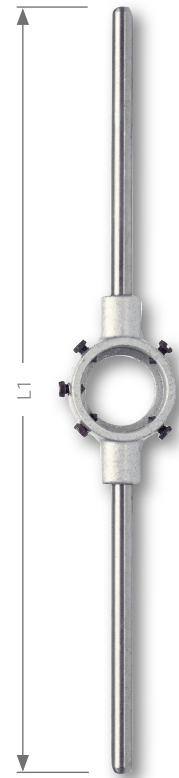

Verstellbare Windeisen DIN 1814

Ideal zum Gewindeschneiden an schwer zugänglichen Stellen.
Mit Zweiback-Spannfutter zum Spannen von Vierkantschäften.
Mit Stahlgriffen, davon ein Griff abschraubbar.

Ausführung: Gehäuse aus Zinkdruckguß
Spannbacken: gehärtet

Verpackungseinheit: einzeln in Kunststoffverpackung

Größe	L1 mm	für Handgewindebohrer			No.	
		M	Ww	G		
0	125,0	M 1 - M 8	1/16 - 5/16	—	241 100	1
1	175,0	M 1 - M 10	1/8 - 3/8	—	241 101	1
1 1/2	175,0	M 1 - M 12	1/8 - 1/2	1/8	241 112	1
2	265,0	M 4 - M 12	3/16 - 5/8	1/8 - 3/8	241 102	1
3	370,0	M 5 - M 20	1/4 - 3/4	1/8 - 1/2	241 103	1
4	480,0	M 11 - M 27	1/2 - 1	1/8 - 3/4	241 104	1
5	700,0	M 13 - M 32	5/8 - 1 1/4	1/4 - 1	241 105	1
6	1000,0	M 19 - M 38	3/4 - 1 1/2	1/4 - 1 1/4	241 106	1
7	1250,0	M 25 - M 52	7/8 - 2	5/8 - 2 1/4	241 107	1

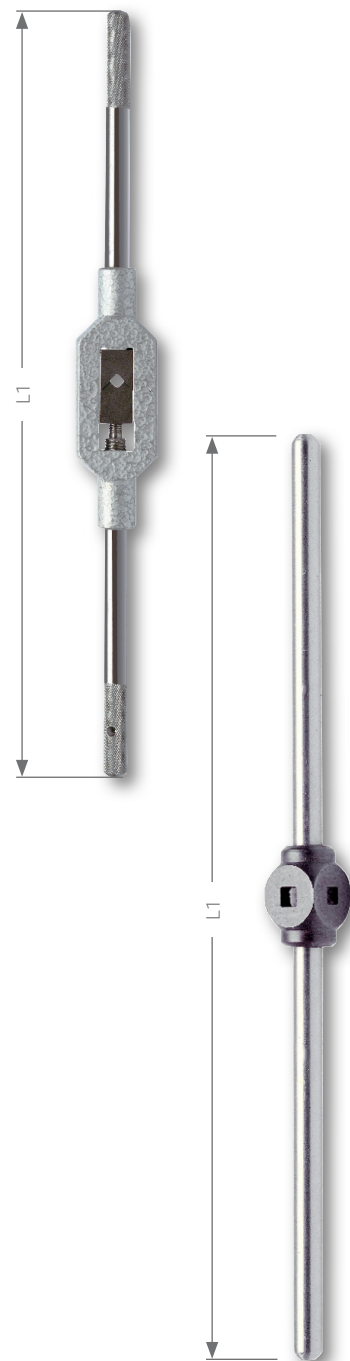

Kugelwindeisen

Ideal zur schnellen Aufnahme von Gewindebohrern.

Ausführung: Gehäuse aus Zinkdruckguß
Schaft: Vierkant nach DIN 10

Verpackungseinheit: einzeln in Kunststoffverpackung

Größe	L1 mm	für Handgewindebohrer			No.	
		M	Ww	G		
0	200,0	M 1 - M 4	1/16 - 5/32	—	241 200	1
1	200,0	M 3,5 - M 8	5/32 - 5/16	—	241 201	1
2	240,0	M 4 - M 10	5/32 - 3/8	—	241 202	1
3	300,0	M 5 - M 12	7/32 - 1/2	—	241 203	1
4	340,0	M 9 - M 16	3/8 - 5/8	—	241 204	1
5	450,0	M 12 - M 20	1/2 - 13/16	—	241 205	1
6	650,0	M 18 - M 27	11/16 - 1	—	241 206	1

Werkzeughalter mit Knarre

Ideal zum Gewindeschneiden an schwer zugänglichen Stellen.
Mit Zweiback-Spannfutter zum Spannen von Vierkantschäften.

Ausführung: einstellbar links, rechts, fest
Schaft: verschiebbarer Quergriff mit Rillen an beiden Enden
Oberfläche: verchromt

Verpackungseinheit: einzeln in Kunststoffverpackung

Größe	L1 mm	für Handgewindebohrer			No.	
		M	Ww	G		
1	85,0	M 3 - M 10	1/8 - 3/8	—	241 001	1
2	100,0	M 5 - M 12	7/32 - 1/2	1/8	241 002	1
10	250,0	M 3 - M 10	1/8 - 3/8	—	241 010	1
20	300,0	M 5 - M 12	7/32 - 1/2	1/8	241 020	1



Artikel- und Anwendungsübersicht:













Werkstoff	Oberfläche	DIN	Form	rechts / linksschneidend	Gewinde	Festigkeitsklassen	Sacklochbohrung / Durchgangslochbohrung	Nennmaß	Art. Nr.	Seite
HSS		DIN 371	B		M	800 N/mm ²		M 2 - M 10	232 020 - 232 100	164
HSSE Co 5		DIN 371	B		M	1000 N/mm ²		M 2 - M 10	232 020 E - 232 100 E	164
HSSE Co 5		DIN 371	B		M	1000 N/mm ²		M 2 - M 10	232 020 VA - 232 100 VA	164
HSS	TIN	DIN 371	B		M	900 N/mm ²		M 2 - M 10	232 020 T - 232 100 T	164
HSSE Co 5	TiAIN	DIN 371	B		M	1200 N/mm ²		M 2 - M 10	232 020 EF - 232 100 EF	164
HSS		DIN 371	C		M	800 N/mm ²		M 2 - M 10	234 020 - 234 100	165
HSSE Co 5		DIN 371	C		M	1000 N/mm ²		M 2 - M 10	234 020 E - 234 100 E	165
HSSE Co 5		DIN 371	C		M	1000 N/mm ²		M 2 - M 10	234 020 VA - 234 100 VA	165
HSS	TIN	DIN 371	C		M	900 N/mm ²		M 2 - M 10	234 020 T - 234 100 T	165
HSSE Co 5	TiAIN	DIN 371	C		M	1200 N/mm ²		M 2 - M 10	234 020 EF - 234 100 EF	165
HSS		DIN 376	B		M	800 N/mm ²		M 12 - M 30	232 120 - 232 300	166
HSSE Co 5		DIN 376	B		M	1000 N/mm ²		M 3 - M 30	232 031 E - 232 300 E	166
HSSE Co 5		DIN 376	B		M	1000 N/mm ²		M 3 - M 30	232 031 VA - 232 300 VA	166
HSS	TIN	DIN 376	B		M	900 N/mm ²		M 12 - M 30	232 120 T - 232 300 T	166
HSSE Co 5	TiAIN	DIN 376	B		M	1200 N/mm ²		M 3 - M 30	232 031 EF - 232 300 EF	166
HSS		DIN 376	C		M	800 N/mm ²		M 12 - M 30	233 120 - 233 300	167
HSSE Co 5		DIN 376	C		M	1000 N/mm ²		M 3 - M 30	233 030 E - 233 300 E	167
HSSE Co 5		DIN 376	C		M	1000 N/mm ²		M 3 - M 30	233 030 VA - 233 300 VA	167
HSS	TIN	DIN 376	C		M	900 N/mm ²		M 12 - M 30	233 120 T - 233 300 T	167
HSSE Co 5	TiAIN	DIN 376	C		M	1200 N/mm ²		M 3 - M 30	233 030 EF - 233 300 EF	167
HSS		DIN 371	B _{AZ}		M	800 N/mm ²		M 3 - M 10	272 030 - 272 100	170
HSS		DIN 376	B _{AZ}		M	800 N/mm ²		M 12 - M 24	272 120 - 272 240	170

Stahl (N/mm ²) < 800	Stahl (N/mm ²) < 1000	Stahl (N/mm ²) < 1200	rostfreier Stahl	Aluminium	Messing	Bronze	Kunststoffe	Gusseisen	Titan legiert
■				□	■	□	□	□	
■	■		□	□	■	□	□	□	
■	■		□	□	■	□	□	□	
■	□		□		■	□	□	□	
■	■	■	■	□	■	■	□	□	□
■				□	■	□	□	□	
■	■		□	□	■	□	□	□	
■	■		□	□	■	□	□	□	
■	□		□		■	□	□	□	
■	■	■	■	□	■	■	□	□	□
■				□	■	□	□	□	
■	■		□	□	■	□	□	□	
■	■		□	□	■	□	□	□	
■	□		□		■	□	□	□	
■	■	■	■	□	■	■	□	□	□
■				□	■	□	□	□	
■	■		□	□	■	□	□	□	
■	■		□	□	■	□	□	□	
■	□		□		■	□	□	□	
■	■	■	■	□	■	■	□	□	□
□				■	□		■		
□				■	□		■		

Artikel- und Anwendungsübersicht:



Werkstoff	Oberfläche	DIN	Form	rechts / linksschneidend	Gewinde	Festigkeitsklassen	Sacklochbohrung / Durchgangslochbohrung	Nennmaß	Art. Nr.	Seite
HSSE Co 5	TiCN	DIN 371	B		M	800 N/mm²		M 3 - M 10	273 030 ETC - 273 100 ETC	171
HSSE Co 5	TiCN	DIN 376	C		M	1000 N/mm²		M 12 - M 24	273 120 ETC - 273 240 ETC	171
HSSE Co 5		DIN 5156	B		G (BSP)	1000 N/mm²		G 1/8 - G 2"	262 018 E - 262 020 E	172
HSSE Co 5		DIN 5156	C		G (BSP)	1000 N/mm²		G 1/8 - G 2"	263 018 E - 263 020 E	172
HSSE Co 5		DIN 374	B		MF	1000 N/mm²		MF 4 - MF 30	260 041 E - 260 302 E	174
HSSE Co 5		DIN 374	C		MF	1000 N/mm²		MF 4 - MF 30	261 041 E - 261 302 E	175
HSSE Co 5			B		UNC	1000 N/mm²		Nr. 4 - 3/8	265 040 UNC - 265 038 UNC	176
HSSE Co 5			B		UNC	1000 N/mm²		7/16 - 1"	265 716 UNC - 265 010 UNC	176
HSSE Co 5			C		UNC	1000 N/mm²		Nr. 4 - 3/8	266 040 UNC - 266 038 UNC	177
HSSE Co 5			C		UNC	1000 N/mm²		7/16 - 1"	266 716 UNC - 266 010 UNC	177
HSSE Co 5			B		UNF	1000 N/mm²		Nr. 4 - 3/8	265 040 UNF - 265 038 UNF	178
HSSE Co 5			B		UNF	1000 N/mm²		7/16 - 1"	265 716 UNF - 265 010 UNF	178
HSSE Co 5			C		UNF	1200 N/mm²		Nr. 4 - 3/8	266 040 UNF - 266 038 UNF	179
HSSE Co 5			C		UNF	1000 N/mm²		7/16 - 1"	266 716 UNF - 266 010 UNF	179
HSS		DIN 40430	B		PG	800 N/mm²		PG 7 - PG 48	264 007 - 264 048	180
HSS		DIN 357			M	800 N/mm²		M 3 - M 24	243 030 - 243 240	180
HSSE Co 5		DIN 2174	D		M	1000 N/mm²		M 3 - M 12	271 003 N - 271 012 N	181
HSSE Co 5	TiAIN	DIN 2174	D		M	1200 N/mm²		M 3 - M 12	271 003 F - 271 012 F	181
HSS					M	600 N/mm²		M 3 - M 10	270 014 - 270 019	182 - 183
HSS	TiN				M	900 N/mm²		M 3 - M 10	270 014 T - 270 019 T	182 - 183
HSS					M	600 N/mm²		M 3 - M 10	R 270 014 - R 270 019	182 - 183
HSS	TiN				M	900 N/mm²		M 3 - M 10	R 270 014 T - R 270 019 T	182 - 183

Stahl (N/mm ²) < 800 	Stahl (N/mm ²) < 1000 	Stahl (N/mm ²) < 1200 	rostfreier Stahl 	Aluminium 	Messing 	Bronze 	Kunststoffe 	Gusseisen 	Titan legiert 
■	■	□	■	□	■	□	□	□	
■	■	□	■	□	■	□	□	□	
■	■		□	□	■	□	□	□	
■	■		□	□	■	□	□	□	
■	■		□	□	■	□	□	□	
■	■		□	□	■	□	□	□	
■	■		□	□	■	□	□	□	
■	■		□	□	■	□	□	□	
■	■		□	□	■	□	□	□	
■	■		□	□	■	□	□	□	
■	■		□	□	■	□	□	□	
■	■		□	□	■	□	□	□	
■	■		□	□	■	□	□	□	
■	■		□	□	■	□	□	□	
■	■		□	□	■	□	□	□	
■	■		□	□	■	□	□	□	
■	■		□	□	■	□	□	□	
■	■		□	□	■	□	□	□	
■	■	■	■	□	■	□	□	□	□
□				■	■	□	■	□	
■	□		□		■	□	□	□	
□				■	■	□	■	□	
■	□		□		■	□	□	□	

Produktbeschreibung für Maschinengewindebohrer



HSS

Maschinengewindebohrer aus Hochleistungs-Schnellarbeitsstahl. Für Durchgangsgewinde und Sacklochgewinde, in unlegierte Stähle bis 800 N/mm² Festigkeit. Das Gewinde wird in einem Arbeitsgang geschnitten.

Schnellarbeitsstahl, vor allem bekannt als High Speed Steel, bezeichnet eine Gruppe legierter Werkzeugstähle mit bis zu 2,06% Kohlenstoffgehalt und bis zu 30% Anteil an Legierungselementen wie Wolfram, Molybdän, Vanadium, Kobalt, Nickel und Titan. HSS-Werkstoffe zeichnen sich durch große Härte, Verschleißfestigkeit und eine Warmfestigkeit bis 600°C aus. Die HSS-Werkzeuge sind unempfindlicher gegen Stöße und Schwingungen, die bei den härteren Schneidwerkstoffen teils rasch zu Brüchen führen können.



HSSE-Co 5

Maschinengewindebohrer aus kobaltlegiertem Hochleistungs-Schnellarbeitsstahl. Durch die höhere Warmhärtebeständigkeit wird eine höhere Standzeit erreicht. Für Durchgangsgewinde und Sacklochgewinde, in unlegierte und legierte Stähle bis 1000 N/mm² Festigkeit und NE-Metalle. Das Gewinde wird in einem Arbeitsgang geschnitten.

Wie HSS-Schnellarbeitsstahl, mit Kobaltlegierung 5%. Dieser warmfeste Werkstoff wird für die Bearbeitung von Materialien mit höherer Festigkeit und bei langen Schnittkanälen mit entsprechend starker Erwärmung eingesetzt. Der Kobaltanteil von 5% sorgt für eine höhere Warmfestigkeit, sowie für höhere Belastbarkeit.



HSSE-Co 5 VAP für VA Stähle

Maschinengewindebohrer aus kobaltlegiertem und vaporisiertem Hochleistungs-Schnellarbeitsstahl. Für Durchgangsgewinde und Sacklochgewinde, in unlegierte und legierte Stähle bis 1000 N/mm² Festigkeit, VA-Metalle. Das Gewinde wird in einem Arbeitsgang geschnitten.

Mit "Vaporisieren" ist das Aufdampfen einer nicht metallischen Oxydschicht gemeint. Vaporisieren wirkt als Trennschicht und vermindert das Entstehen von Kaltaufschweißungen. Bei Kaltaufschweißungen handelt es sich um Werkstückspäne, die sich auf der Flanke des Gewindebohrer aufschweißen und das gefertigte Gewinde beschädigen. Folgen von Kaltaufschweißungen sind aufgerissene und unsaubere Gewindeflanken.

VAP verbessert die Haftung von Schmiermitteln an der Werkzeugoberfläche.



Produktbeschreibung für Maschinengewindebohrer



HSS-TiN

Maschinengewindebohrer aus Hochleistungs-Schnellarbeitsstahl mit Titan-Nitrid-Beschichtung. Universeller Einsatz für breite Werkstoffpalette durch Hartstoffschicht. Für Durchgangsgewinde und Sacklochgewinde, in unlegierte und legierte Stähle bis 900 N/mm² Festigkeit, VA-Metalle. Das Gewinde wird in einem Arbeitsgang geschnitten. Hinweis: Schnittgeschwindigkeiten ab 10 m/min.

Durch die TiN Verschleißschutzbeschichtung erhöht sich die Oberflächenhärte auf ca. 2.500 HV. Titanitrid ist eine chemische Verbindung der beiden Elemente Titan und Stickstoff. TiN ist ein metallischer Hartstoff von typisch goldgelber Farbe. Vorteile: Höhere Härte, geringer Reibungskoeffizient, höhere Standzeit.

Kühlung nicht notwendig, wird aber empfohlen.



HSSE-Co 5 TiAlN

Maschinengewindebohrer aus Hochleistungs-Schnellarbeitsstahl. Für Durchgangsgewinde und Sacklochgewinde, in unlegierte, niedriglegierte, legierte Stähle bis 1200 N/mm² Festigkeit und Guß. Das Gewinde wird in einem Arbeitsgang geschnitten.

Durch die TiAlN Verschleißschutzbeschichtung erhöht sich die Oberflächenhärte auf ca. 3.500 HV. Titan-Aluminium-Nitrid ist eine chemische Verbindung der drei Elemente Titan, Aluminium und Stickstoff. TiAlN ist ein metallischer Hartstoff von typisch schwarz-violetter Farbe.

Vorteile: Die TiAlN-Beschichtung ermöglicht die Trockenbearbeitung von Zerspanungswerkzeugen, ein Kühlen ist nicht notwendig. Höhere Härte, sehr geringer Reibungskoeffizient, optimale Standzeiten.



Technische Daten:

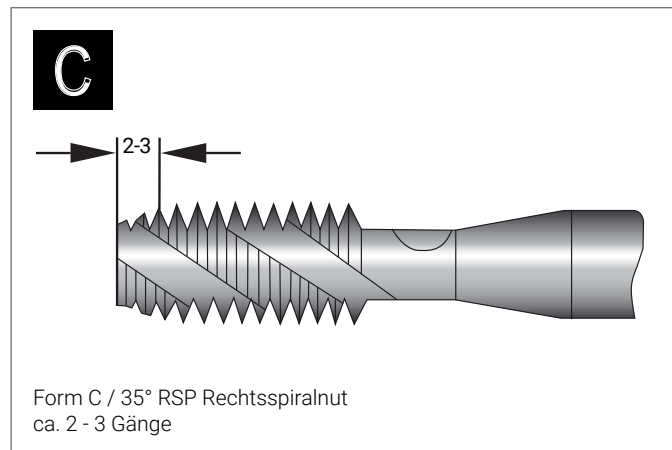
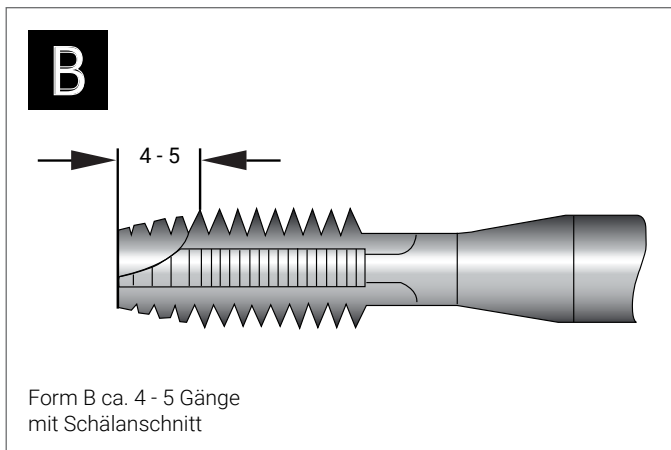



Maschinengewindebohrer M DIN 371 HSS und HSSE-Co 5, geschliffen

Maschinengewindebohrer mit verstärktem Schaft für Durchgangsgewinde.

Anschnitt: Form B ca. 4 - 5 Gänge mit Schälanschnitt
 Gewinde: metrisch DIN ISO 13
 Flanken: hinterschliffen

Verpackungseinheit: einzeln in Kunststoffverpackung

Um die Standzeit zu erhöhen - Drehzahl reduzieren!
Kühlen beim Senken!

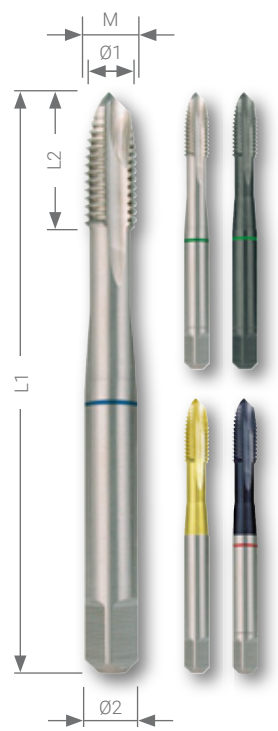

Stahl (N/mm ²) < 800	■	■	■	■	■
Stahl (N/mm ²) < 1000		■	■	□	■
Stahl (N/mm ²) < 1200					■
rostfreier Stahl		□	□	□	■
Aluminium	□	□	□		□

Messing	■	■	■	■	■
Bronze	□	□	□	□	■
Kunststoffe	□	□	□	□	□
Gusseisen	□	□	□	□	□
Titan legiert					□

Gewinde Nennmaß M	Steigung mm	Kernloch Ø1 mm	L1 mm	L2 max. mm	Ø2 mm
M 2	0,40	1,60	45,0	8,0	2,8
M 2,5	0,45	2,05	50,0	9,0	2,8
M 3	0,50	2,50	56,0	11,0	3,5
M 4	0,70	3,30	63,0	13,0	4,5
M 5	0,80	4,20	70,0	16,0	6,0
M 6	1,00	5,00	80,0	19,0	6,0
M 8	1,25	6,80	90,0	22,0	8,0
M 10	1,50	8,50	100,0	24,0	10,0

Gewinde Nennmaß M	HSS	800 N/mm ²	HSSE Co 5	1000 N/mm ²	HSSE Co 5	1000 N/mm ²	HSS	TiN	900 N/mm ²	HSSE Co 5	TiAlN	1200 N/mm ²	
M 2		232 020		232 020 E		232 020 VA		232 020 T		232 020 EF			1
M 2,5		232 025		232 025 E		232 025 VA		232 025 T		232 025 EF			1
M 3		232 030		232 030 E		232 030 VA		232 030 T		232 030 EF			1
M 4		232 040		232 040 E		232 040 VA		232 040 T		232 040 EF			1
M 5		232 050		232 050 E		232 050 VA		232 050 T		232 050 EF			1
M 6		232 060		232 060 E		232 060 VA		232 060 T		232 060 EF			1
M 8		232 080		232 080 E		232 080 VA		232 080 T		232 080 EF			1
M 10		232 100		232 100 E		232 100 VA		232 100 T		232 100 EF			1

Abbildung schematisch. Kleinere Durchmesser können produktionsbedingt mit Spitze geliefert werden.



Maschinengewindebohrer M DIN 371 HSS und HSSE-Co 5, geschliffen

Maschinengewindebohrer mit verstärktem Schaft und Rechtsspiralnuten 35° RSP für Sacklochgewinde.

Anschnitt: Form C / 35° RSP ca. 2 - 3 Gänge
 Gewinde: metrisch DIN ISO 13
 Flanken: hinterschliffen

Verpackungseinheit: einzeln in Kunststoffverpackung

Um die Standzeit zu erhöhen - Drehzahl reduzieren!
Kühlen beim Senken!



Stahl (N/mm ²) < 800	■	■	■	■	■
Stahl (N/mm ²) < 1000		■	■	□	■
Stahl (N/mm ²) < 1200					■
rostfreier Stahl		■	■	□	■
Aluminium	□	□	□		□

Messing	■	■	■	■	■
Bronze	□	□	□	□	■
Kunststoffe	□	□	□	□	□
Gusseisen	□	□	□	□	□
Titan legiert					□

Gewinde Nennmaß M	Steigung mm	Kernloch Ø1 mm	L1 mm	L2 max. mm	Ø2 mm
M 2	0,40	1,60	45,0	8,0	2,8
M 2,5	0,45	2,05	50,0	9,0	2,8
M 3	0,50	2,50	56,0	11,0	3,5
M 4	0,70	3,30	63,0	13,0	4,5
M 5	0,80	4,20	70,0	16,0	6,0
M 6	1,00	5,00	80,0	19,0	6,0
M 8	1,25	6,80	90,0	22,0	8,0
M 10	1,50	8,50	100,0	24,0	10,0

Gewinde Nennmaß M	HSS	HSSE Co 5 800 N/mm ²	HSSE Co 5 1000 N/mm ²	HSSE Co 5 1000 N/mm ²	HSS TIN 900 N/mm ²	HSSE Co 5 TAIN 1200 N/mm ²	
M 2	234 020	234 020 E	234 020 VA	234 020 T	234 020 EF	1	
M 2,5	234 025	234 025 E	234 025 VA	234 025 T	234 025 EF	1	
M 3	234 030	234 030 E	234 030 VA	234 030 T	234 030 EF	1	
M 4	234 040	234 040 E	234 040 VA	234 040 T	234 040 EF	1	
M 5	234 050	234 050 E	234 050 VA	234 050 T	234 050 EF	1	
M 6	234 060	234 060 E	234 060 VA	234 060 T	234 060 EF	1	
M 8	234 080	234 080 E	234 080 VA	234 080 T	234 080 EF	1	
M 10	234 100	234 100 E	234 100 VA	234 100 T	234 100 EF	1	

Abbildung schematisch. Kleinere Durchmesser können produktionsbedingt mit Spitze geliefert werden.



Maschinengewindebohrer M DIN 376 HSS und HSSE-Co 5, geschliffen

Maschinengewindebohrer mit Überlaufschaft für Durchgangsgewinde.

Anschnitt: Form B ca. 4 - 5 Gänge mit Schälanschnitt
 Gewinde: metrisch DIN ISO 13
 Flanken: hinterschliffen

Verpackungseinheit: einzeln in Kunststoffverpackung

Abbildung schematisch. Kleinere Durchmesser können produktionsbedingt mit Spitze geliefert werden.

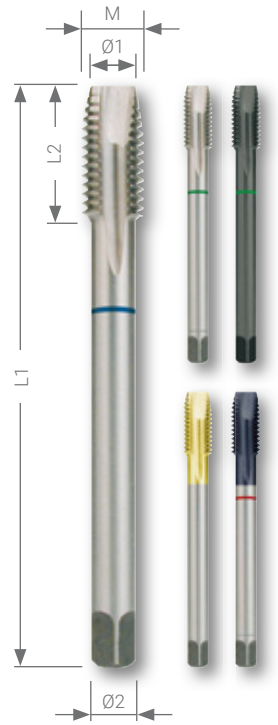

Stahl (N/mm ²) < 800	■	■	■	■	■
Stahl (N/mm ²) < 1000		■	■	□	■
Stahl (N/mm ²) < 1200					■
rostfreier Stahl		■	■	□	■
Aluminium	□	□	□		□

Messing	■	■	■	■	■
Bronze	□	□	□	□	■
Kunststoffe	□	□	□	□	□
Gusseisen	□	□	□	□	□
Titan legiert					□

Gewinde Nennmaß M	Steigung mm	Kernloch Ø1 mm	L1 mm	L2 max. mm	Ø2 mm
M 3	0,50	2,50	56,0	11,0	2,2
M 4	0,70	3,30	63,0	13,0	2,8
M 5	0,80	4,20	70,0	16,0	3,5
M 6	1,00	5,00	80,0	19,0	4,5
M 8	1,25	6,80	90,0	22,0	6,0
M 10	1,50	8,50	100,0	24,0	7,0
M 12	1,75	10,20	110,0	28,0	9,0
M 14	2,00	12,00	110,0	30,0	11,0
M 16	2,00	14,00	110,0	32,0	12,0
M 18	2,50	15,50	125,0	34,0	14,0
M 20	2,50	17,50	140,0	34,0	16,0
M 22	2,50	19,50	140,0	34,0	18,0
M 24	3,00	21,00	160,0	38,0	18,0
M 27	3,00	24,00	160,0	38,0	20,0
M 30	3,50	26,50	180,0	45,0	22,0

Gewinde Nennmaß M	HSS	800 N/mm ²	HSSE Co 5	1000 N/mm ²	HSSE Co 5	1000 N/mm ²	HSS	TiN	900 N/mm ²	HSSE Co 5	TiAlN	1200 N/mm ²	
M 3	—	—	232 031 E	—	232 031 VA	—	—	—	—	232 031 EF	—	—	1
M 4	—	—	232 041 E	—	232 041 VA	—	—	—	—	232 041 EF	—	—	1
M 5	—	—	232 051 E	—	232 051 VA	—	—	—	—	232 051 EF	—	—	1
M 6	—	—	232 061 E	—	232 061 VA	—	—	—	—	232 061 EF	—	—	1
M 8	—	—	232 081 E	—	232 081 VA	—	—	—	—	232 081 EF	—	—	1
M 10	—	—	232 101 E	—	232 101 VA	—	—	—	—	232 101 EF	—	—	1
M 12	232 120	—	232 120 E	—	232 120 VA	—	232 120 T	—	—	232 120 EF	—	—	1
M 14	232 140	—	232 140 E	—	232 140 VA	—	232 140 T	—	—	232 140 EF	—	—	1
M 16	232 160	—	232 160 E	—	232 160 VA	—	232 160 T	—	—	232 160 EF	—	—	1
M 18	232 180	—	232 180 E	—	232 180 VA	—	232 180 T	—	—	232 180 EF	—	—	1
M 20	232 200	—	232 200 E	—	232 200 VA	—	232 200 T	—	—	232 200 EF	—	—	1
M 22	232 220	—	232 220 E	—	232 220 VA	—	232 220 T	—	—	232 220 EF	—	—	1
M 24	232 240	—	232 240 E	—	232 240 VA	—	232 240 T	—	—	232 240 EF	—	—	1
M 27	232 270	—	232 270 E	—	232 270 VA	—	232 270 T	—	—	232 270 EF	—	—	1
M 30	232 300	—	232 300 E	—	232 300 VA	—	232 300 T	—	—	232 300 EF	—	—	1



Maschinengewindebohrer M DIN 376 HSS und HSSE-Co 5, geschliffen

Maschinengewindebohrer mit Überlaufschaft
und Rechtsspiralnuten 35° RSP für Sacklochgewinde.

Anschnitt: Form C / 35° RSP ca. 2 - 3 Gänge
Gewinde: metrisch DIN ISO 13
Flanken: hinterschliffen

Verpackungseinheit: einzeln in Kunststoffverpackung

Abbildung schematisch. Kleinere Durchmesser können produktionsbedingt mit Spitze geliefert werden.



Stahl (N/mm ²) < 800	■	■	■	■	■
Stahl (N/mm ²) < 1000		■	■	□	■
Stahl (N/mm ²) < 1200					■
rostfreier Stahl		■	■	□	■
Aluminium	□	□	□		□







Messing	■	■	■	■	■
Bronze	□	□	□	□	■
Kunststoffe	□	□	□	□	□
Gusseisen	□	□	□	□	□
Titan legiert					□

Gewinde Nennmaß M	Steigung mm	Kernloch Ø1 mm	L1 mm	L2 max. mm	Ø2 mm
M 3	0,50	2,50	56,0	11,0	2,2
M 4	0,70	3,30	63,0	13,0	2,8
M 5	0,80	4,20	70,0	16,0	3,5
M 6	1,00	5,00	80,0	19,0	4,5
M 8	1,25	6,80	90,0	22,0	6,0
M 10	1,50	8,50	100,0	24,0	7,0
M 12	1,75	10,20	110,0	28,0	9,0
M 14	2,00	12,00	110,0	30,0	11,0
M 16	2,00	14,00	110,0	32,0	12,0
M 18	2,50	15,50	125,0	34,0	14,0
M 20	2,50	17,50	140,0	34,0	16,0
M 22	2,50	19,50	140,0	34,0	18,0
M 24	3,00	21,00	160,0	38,0	18,0
M 27	3,00	24,00	160,0	38,0	20,0
M 30	3,50	26,50	180,0	45,0	22,0

Gewinde Nennmaß M	HSS	800 N/mm ²	HSSE Co 5	1000 N/mm ²	HSSE Co 5	1000 N/mm ²	HSS	TIN	900 N/mm ²	HSSE Co 5	TiAlN	1200 N/mm ²	
M 3	—	—	233 030 E	233 030 VA	—	—	—	—	—	233 030 EF	—	—	1
M 4	—	—	233 040 E	233 040 VA	—	—	—	—	—	233 040 EF	—	—	1
M 5	—	—	233 050 E	233 050 VA	—	—	—	—	—	233 050 EF	—	—	1
M 6	—	—	233 060 E	233 060 VA	—	—	—	—	—	233 060 EF	—	—	1
M 8	—	—	233 080 E	233 080 VA	—	—	—	—	—	233 080 EF	—	—	1
M 10	—	—	233 100 E	233 100 VA	—	—	—	—	—	233 100 EF	—	—	1
M 12	233 120	—	233 120 E	233 120 VA	233 120 T	—	—	—	—	233 120 EF	—	—	1
M 14	233 140	—	233 140 E	233 140 VA	233 140 T	—	—	—	—	233 140 EF	—	—	1
M 16	233 160	—	233 160 E	233 160 VA	233 160 T	—	—	—	—	233 160 EF	—	—	1
M 18	233 180	—	233 180 E	233 180 VA	233 180 T	—	—	—	—	233 180 EF	—	—	1
M 20	233 200	—	233 200 E	233 200 VA	233 200 T	—	—	—	—	233 200 EF	—	—	1
M 22	233 220	—	233 220 E	233 220 VA	233 220 T	—	—	—	—	233 220 EF	—	—	1
M 24	233 240	—	233 240 E	233 240 VA	233 240 T	—	—	—	—	233 240 EF	—	—	1
M 27	233 270	—	233 270 E	233 270 VA	233 270 T	—	—	—	—	233 270 EF	—	—	1
M 30	233 300	—	233 300 E	233 300 VA	233 300 T	—	—	—	—	233 300 EF	—	—	1









Maschinengewindebohrer-Sätze HSS und HSSE-Co 5 in Industriekassette

		HSS	HSSE Co 5	HSSE Co 5	HSS TIN	HSSE Co 5 TiAlN
B 	7-teiliger Maschinengewindebohrer-Satz M DIN 371 / 376 Form B mit Schälanschnitt M 3 - M 4 - M 5 - M 6 - M 8 - M 10 - M 12	245 057	245 061	245 063	245 065	245 068
C 	7-teiliger Maschinengewindebohrer-Satz M DIN 371 / 376 Form C / 35° RSP M 3 - M 4 - M 5 - M 6 - M 8 - M 10 - M 12	245 058	245 062	245 064	245 066	245 069
B 	14-teiliger Maschinengewindebohrer-Satz 7 Maschinengewindebohrer M DIN 371 / 376 Form B mit Schälanschnitt M 3 - M 4 - M 5 - M 6 - M 8 - M 10 - M 12 + 7 Spiralbohrer DIN 338 Typ N Ø 2,5 - 3,3 - 4,2 - 5,0 - 6,8 - 8,5 - 10,2 mm	245 048	245 051	—	—	—
C 	14-teiliger Maschinengewindebohrer-Satz 7 Maschinengewindebohrer M DIN 371 / 376 Form C / 35° RSP M 3 - M 4 - M 5 - M 6 - M 8 - M 10 - M 12 + 7 Spiralbohrer DIN 338 Typ N Ø 2,5 - 3,3 - 4,2 - 5,0 - 6,8 - 8,5 - 10,2 mm	245 049	245 052	—	—	—
B  C 	21-teiliger Maschinengewindebohrer-Satz 7 Maschinengewindebohrer M DIN 371 / 376 Form B mit Schälanschnitt M 3 - M 4 - M 5 - M 6 - M 8 - M 10 - M 12 + 7 Maschinengewindebohrer M DIN 371 / 376 Form C / 35° RSP M 3 - M 4 - M 5 - M 6 - M 8 - M 10 - M 12 + 7 Spiralbohrer DIN 338 Typ N Ø 2,5 - 3,3 - 4,2 - 5,0 - 6,8 - 8,5 - 10,2 mm	—	245 054	—	—	—



Maschinengewindebohrer-Sätze HSS und HSSE-Co 5 in ABS-Kunststoffkassette

		HSS	HSSE Co 5	HSSE Co 5	HSS TIN	HSSE Co 5 TiAIN
B 	7-teiliger Maschinengewindebohrer-Satz M DIN 371 / 376 Form B mit Schälanschnitt M 3 - M 4 - M 5 - M 6 - M 8 - M 10 - M 12	245 057 RO	245 061 RO	245 063 RO	245 065 RO	245 068 RO
C 	7-teiliger Maschinengewindebohrer-Satz M DIN 371 / 376 Form C / 35° RSP M 3 - M 4 - M 5 - M 6 - M 8 - M 10 - M 12	245 058 RO	245 062 RO	245 064 RO	245 066 RO	245069 RO
B 	14-teiliger Maschinengewindebohrer-Satz 7 Maschinengewindebohrer M DIN 371 / 376 Form B mit Schälanschnitt M 3 - M 4 - M 5 - M 6 - M 8 - M 10 - M 12 + 7 Spiralbohrer DIN 338 Typ N Ø 2,5 - 3,3 - 4,2 - 5,0 - 6,8 - 8,5 - 10,2 mm	245 048 RO	245 051 RO	—	—	—
C 	14-teiliger Maschinengewindebohrer-Satz 7 Maschinengewindebohrer M DIN 371 / 376 Form C / 35° RSP M 3 - M 4 - M 5 - M 6 - M 8 - M 10 - M 12 + 7 Spiralbohrer DIN 338 Typ N Ø 2,5 - 3,3 - 4,2 - 5,0 - 6,8 - 8,5 - 10,2 mm	245 049 RO	245 052 RO	—	—	—
B  C 	21-teiliger Maschinengewindebohrer-Satz 7 Maschinengewindebohrer M DIN 371 / 376 Form B mit Schälanschnitt M 3 - M 4 - M 5 - M 6 - M 8 - M 10 - M 12 + 7 Maschinengewindebohrer M DIN 371 / 376 Form C / 35° RSP M 3 - M 4 - M 5 - M 6 - M 8 - M 10 - M 12 + 7 Spiralbohrer DIN 338 Typ N Ø 2,5 - 3,3 - 4,2 - 5,0 - 6,8 - 8,5 - 10,2 mm	—	—	—	—	—





Maschinengewindebohrer M DIN 371/376 HSS, geschliffen, mit ausgesetzten Zähnen

Anschnitt: Form B - AZ ca. 4 - 5 Gänge mit Schälanschnitt und ausgesetzten Zähnen
 Gewinde: metrisch DIN ISO 13
 Flanken: hinterschliffen

Verpackungseinheit: einzeln in Kunststoffverpackung

Stahl (N/mm ²) < 800	<input type="checkbox"/>	Messing	<input type="checkbox"/>
Stahl (N/mm ²) < 1000		Bronze	
Stahl (N/mm ²) < 1200		Kunststoffe	<input checked="" type="checkbox"/>
rostfreier Stahl		Gusseisen	
Aluminium	<input checked="" type="checkbox"/>	Titan legiert	

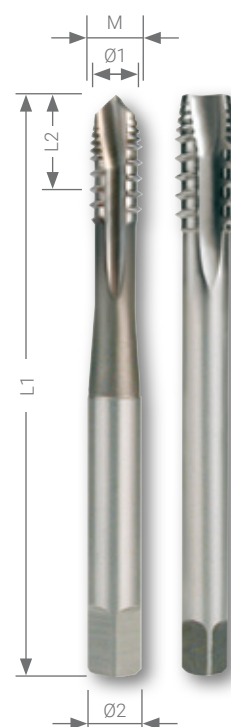

DIN 371 Maschinengewindebohrer mit verstärktem Schaft für Durchgangsgewinde in Aluminium, Aluminium-Legierungen, Bronze, Kupfer, Nickel und Kunststoffe.

Gewinde Nennmaß M	Steigung mm	Kernloch Ø1 mm	L1 mm	L2 max. mm	Ø2 mm	HSS		
M 3	0,50	2,50	56,0	11,0	3,5	272 030		1
M 4	0,70	3,30	63,0	13,0	4,5	272 040		1
M 5	0,80	4,20	70,0	16,0	6,0	272 050		1
M 6	1,00	5,00	80,0	19,0	6,0	272 060		1
M 8	1,25	6,80	90,0	22,0	8,0	272 080		1
M 10	1,50	8,50	100,0	24,0	10,0	272 100		1

DIN 376 Maschinengewindebohrer mit Überlaufschaft für Durchgangsgewinde in Aluminium, Aluminium-Legierungen, Bronze, Kupfer, Nickel und Kunststoffe.

Gewinde Nennmaß M	Steigung mm	Kernloch Ø1 mm	L1 mm	L2 max. mm	Ø2 mm	HSS		
M 12	1,75	10,20	110,0	28,0	9,0	272 120		1
M 14	2,00	12,00	110,0	30,0	11,0	272 140		1
M 16	2,00	14,00	110,0	32,0	12,0	272 160		1
M 18	2,50	15,50	125,0	34,0	14,0	272 180		1
M 20	2,50	17,50	140,0	34,0	16,0	272 200		1
M 22	2,50	19,50	140,0	34,0	18,0	272 220		1
M 24	3,00	21,00	160,0	38,0	18,0	272 240		1

Abbildung schematisch. Kleinere Durchmesser können produktionsbedingt mit Spitze geliefert werden.



Maschinengewindebohrer M DIN 371/376 HSSE-Co 5 TiCN, geschliffen

Anschnitt: Form C / ca. 2 - 3 Gänge
 Gewinde: metrisch DIN ISO 13
 Flanken: hinterschliffen

Verpackungseinheit: einzeln in Kunststoffverpackung

Stahl (N/mm2) < 800	<input checked="" type="checkbox"/>	Messing	<input checked="" type="checkbox"/>
Stahl (N/mm2) < 1000	<input checked="" type="checkbox"/>	Bronze	<input type="checkbox"/>
Stahl (N/mm2) < 1200	<input type="checkbox"/>	Kunststoffe	<input type="checkbox"/>
rostfreier Stahl	<input checked="" type="checkbox"/>	Gusseisen	<input type="checkbox"/>
Aluminium	<input type="checkbox"/>	Titan legiert	<input type="checkbox"/>

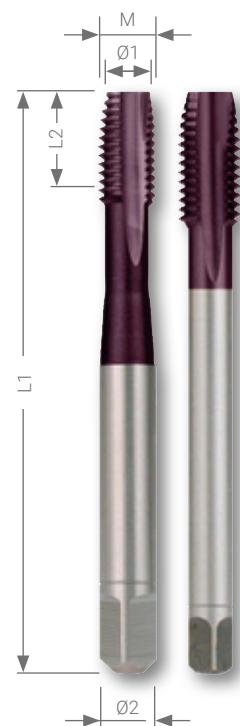

DIN 371 Maschinengewindebohrer mit verstärktem Schaft für Durchgangsgewinde in Gußeisen und Gußlegierungen.

Gewinde Nennmaß M	Steigung mm	Kernloch Ø1 mm	L1 mm	L2 max. mm	Ø2 mm	HSSE Co 5	TiCN	
M 3	0,50	2,50	56,0	11,0	3,5			1
M 4	0,70	3,30	63,0	13,0	4,5			1
M 5	0,80	4,20	70,0	16,0	6,0			1
M 6	1,00	5,00	80,0	19,0	6,0			1
M 8	1,25	6,80	90,0	22,0	8,0			1
M 10	1,50	8,50	100,0	24,0	10,0			1

DIN 376 Maschinengewindebohrer mit Überlaufschaft für Durchgangsgewinde in Gußeisen und Gußlegierungen.

Gewinde Nennmaß M	Steigung mm	Kernloch Ø1 mm	L1 mm	L2 max. mm	Ø2 mm	HSSE Co 5	TiCN	
M 12	1,75	10,20	110,0	29,0	9,0			1
M 14	2,00	12,00	110,0	30,0	11,0			1
M 16	2,00	14,00	110,0	32,0	12,0			1
M 18	2,50	15,50	125,0	34,0	14,0			1
M 20	2,50	17,50	140,0	34,0	16,0			1
M 22	2,50	19,50	140,0	34,0	18,0			1
M 24	3,00	21,00	160,0	38,0	18,0			1

Abbildung schematisch. Kleinere Durchmesser können produktionsbedingt mit Spitze geliefert werden.



Maschinengewindebohrer G DIN 5156 HSSE-Co 5, geschliffen

Gewinde: DIN ISO 228 "G" (zylindrisches Rohrgewinde)
 DIN 2999 "Rp" (Whitworth Rohrgewinde)
 Flanken: hinterschliffen

Verpackungseinheit: einzeln in Kunststoffverpackung

	<input checked="" type="checkbox"/>		<input checked="" type="checkbox"/>
Stahl (N/mm2) < 800	<input checked="" type="checkbox"/>	Messing	<input checked="" type="checkbox"/>
Stahl (N/mm2) < 1000	<input checked="" type="checkbox"/>	Bronze	<input type="checkbox"/>
Stahl (N/mm2) < 1200	<input type="checkbox"/>	Kunststoffe	<input type="checkbox"/>
rostfreier Stahl	<input type="checkbox"/>	Gusseisen	<input type="checkbox"/>
Aluminium	<input type="checkbox"/>	Titan legiert	<input type="checkbox"/>

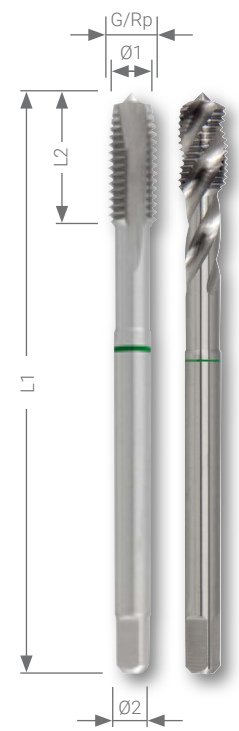

B Maschinengewindebohrer mit Überlaufschaft für Durchgangsgewinde.

Nennmaß G / Rp	Gangzahl pro Zoll	Kernloch Ø1 mm	L1 mm	L2 max. mm	Ø2 mm	HSSE Co 5		
G 1/8 Rp 1/8	28	8,80	90,0	20,0	7,0	262 018 E		1
G 1/4 Rp 1/4	19	11,80	100,0	22,0	11,0	262 014 E		1
G 3/8 Rp 3/8	19	15,25	100,0	22,0	12,0	262 038 E		1
G 1/2 Rp 1/2	14	19,00	125,0	25,0	16,0	262 012 E		1
G 5/8 Rp 5/8	14	21,00	125,0	25,0	18,0	262 058 E		1
G 3/4 Rp 3/4	14	24,50	140,0	28,0	20,0	262 034 E		1
G 7/8 Rp 7/8	14	28,25	150,0	28,0	22,0	262 078 E		1
G 1" Rp 1"	11	30,75	160,0	30,0	25,0	262 010 E		1
G 1 1/8 Rp 1 1/8	11	35,50	170,0	30,0	28,0	262 118 E		1
G 1 1/4 Rp 1 1/4	11	39,50	170,0	30,0	32,0	262 114 E		1
G 1 3/8 Rp 1 3/8	11	41,80	180,0	32,0	36,0	262 138 E		1
G 1 1/2 Rp 1 1/2	11	45,25	190,0	32,0	36,0	262 112 E		1
G 1 3/4 Rp 1 3/4	11	51,30	190,0	32,0	40,0	262 134 E		1
G 2" Rp 2"	11	57,20	220,0	40,0	45,0	262 020 E		1

C Maschinengewindebohrer mit Überlaufschaft und Rechtsspiralnuten 35° RSP für Sacklochgewinde.

Nennmaß G / Rp	Gangzahl pro Zoll	Kernloch Ø1 mm	L1 mm	L2 max. mm	Ø2 mm	HSSE Co 5		
G 1/8 Rp 1/8	28	8,80	90,0	20,0	7,0	263 018 E		1
G 1/4 Rp 1/4	19	11,80	100,0	22,0	11,0	263 014 E		1
G 3/8 Rp 3/8	19	15,25	100,0	22,0	12,0	263 038 E		1
G 1/2 Rp 1/2	14	19,00	125,0	25,0	16,0	263 012 E		1
G 5/8 Rp 5/8	14	21,00	125,0	25,0	18,0	263 058 E		1
G 3/4 Rp 3/4	14	24,50	140,0	28,0	20,0	263 034 E		1
G 7/8 Rp 7/8	14	28,25	150,0	28,0	22,0	263 078 E		1
G 1" Rp 1"	11	30,75	160,0	30,0	25,0	263 010 E		1
G 1 1/8 Rp 1 1/8	11	35,50	170,0	30,0	28,0	263 118 E		1
G 1 1/4 Rp 1 1/4	11	39,50	170,0	30,0	32,0	263 114 E		1
G 1 3/8 Rp 1 3/8	11	41,80	180,0	32,0	36,0	263 138 E		1
G 1 1/2 Rp 1 1/2	11	45,25	190,0	32,0	36,0	263 112 E		1
G 1 3/4 Rp 1 3/4	11	51,30	190,0	32,0	40,0	263 134 E		1
G 2" Rp 2"	11	57,20	220,0	40,0	45,0	263 020 E		1

Abbildung schematisch. Kleinere Durchmesser können produktionsbedingt mit Spitze geliefert werden.

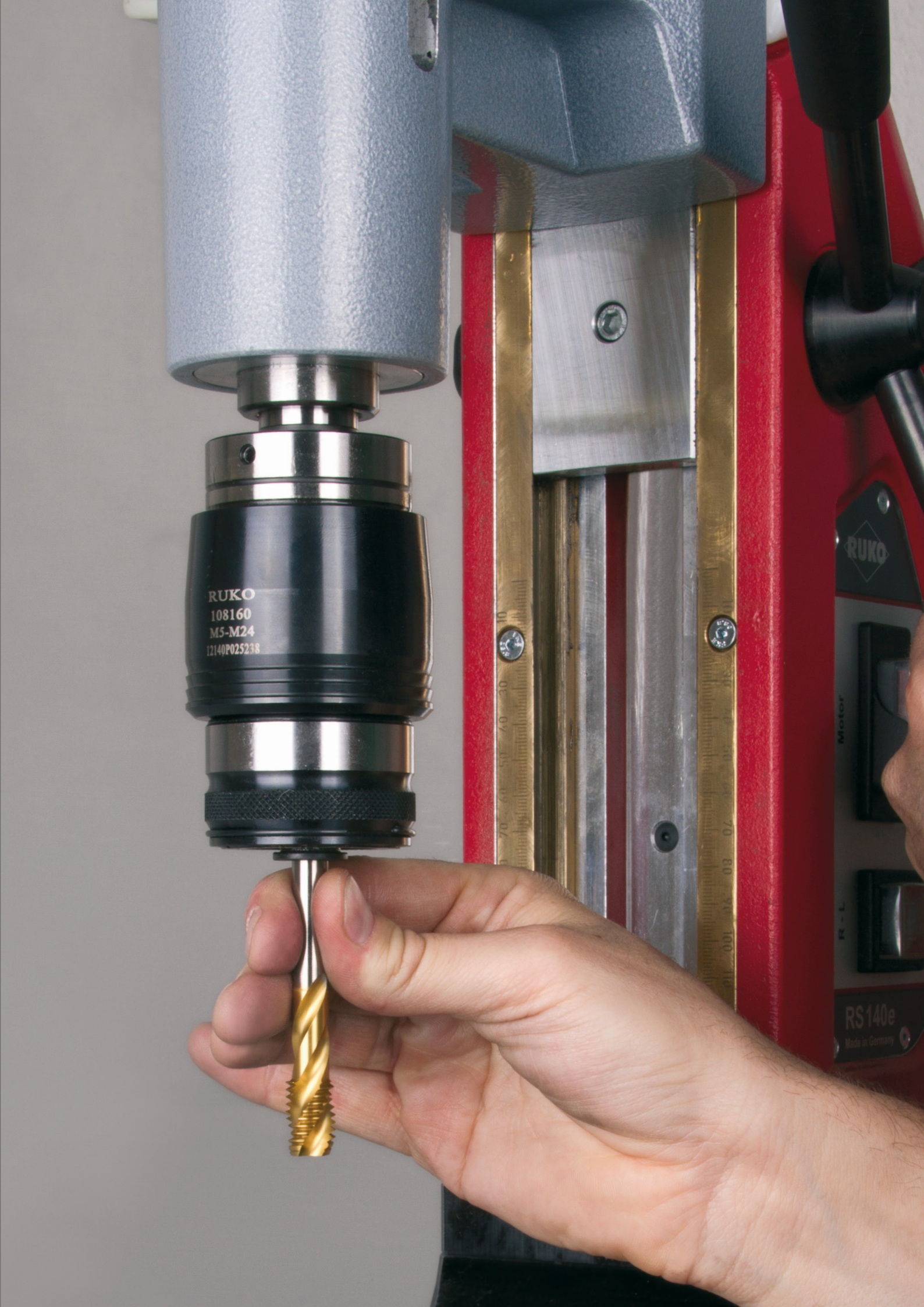

RUKO
108160
MS-M24
12140P025238

RUKO

Motor

R - L

RS140e
Made in Germany



Maschinengewindebohrer MF DIN 374 HSSE-Co 5, geschliffen

Gewinde: metrisch fein DIN ISO 13
Flanken: hinterschliffen

Verpackungseinheit: einzeln in Kunststoffverpackung

Stahl (N/mm2) < 800	■	Messing	■
Stahl (N/mm2) < 1000	■	Bronze	□
Stahl (N/mm2) < 1200		Kunststoffe	□
rostfreier Stahl	□	Gusseisen	□
Aluminium	□	Titan legiert	

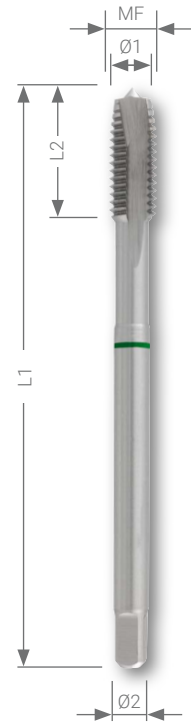

Maschinengewindebohrer mit Überlaufschäft für Durchgangsgewinde.

Gewinde Nennmaß MF	Steigung mm	Kernloch Ø1 mm	L1 mm	L2 max. mm	Ø2 mm	HSSE Co 5		
MF 4	0,50	3,50	63,0	10,0	2,8	260 041 E		1
MF 5	0,50	4,50	70,0	12,0	3,5	260 050 E		1
MF 6	0,75	5,20	80,0	14,0	4,5	260 060 E		1
MF 8	1,00	7,00	90,0	22,0	6,0	260 081 E		1
MF 10	1,00	9,00	90,0	20,0	7,0	260 100 E		1
MF 10	1,25	8,80	100,0	24,0	7,0	260 101 E		1
MF 12	1,00	11,00	100,0	20,0	9,0	260 122 E		1
MF 12	1,25	10,80	100,0	22,0	9,0	260 121 E		1
MF 12	1,50	10,50	100,0	22,0	9,0	260 120 E		1
MF 14	1,00	13,00	100,0	20,0	11,0	260 142 E		1
MF 14	1,25	12,80	100,0	22,0	11,0	260 143 E		1
MF 14	1,50	12,50	100,0	22,0	11,0	260 141 E		1
MF 16	1,00	15,00	100,0	20,0	12,0	260 161 E		1
MF 16	1,50	14,50	100,0	22,0	12,0	260 160 E		1
MF 18	1,00	17,00	110,0	25,0	14,0	260 181 E		1
MF 18	1,50	16,50	110,0	25,0	14,0	260 180 E		1
MF 18	2,00	16,00	125,0	34,0	14,0	260 182 E		1
MF 20	1,00	19,00	125,0	25,0	16,0	260 201 E		1
MF 20	1,50	18,50	125,0	25,0	16,0	260 200 E		1
MF 20	2,00	18,00	140,0	34,0	16,0	260 202 E		1
MF 22	1,50	20,50	125,0	25,0	18,0	260 220 E		1
MF 22	2,00	20,00	140,0	34,0	18,0	260 222 E		1
MF 24	1,00	23,00	140,0	28,0	18,0	260 242 E		1
MF 24	1,50	22,50	140,0	28,0	18,0	260 240 E		1
MF 24	2,00	22,00	140,0	28,0	18,0	260 241 E		1
MF 28	1,50	26,50	140,0	28,0	20,0	260 281 E		1
MF 28	2,00	26,00	140,0	28,0	20,0	260 282 E		1
MF 30	1,50	28,50	150,0	28,0	22,0	260 301 E		1
MF 30	2,00	28,00	150,0	28,0	22,0	260 302 E		1

Abbildung schematisch. Kleinere Durchmesser können produktionsbedingt mit Spitze geliefert werden.



Maschinengewindebohrer MF DIN 374 HSSE-Co 5, geschliffen

Gewinde: metrisch fein DIN ISO 13
Flanken: hinterschliffen

Verpackungseinheit: einzeln in Kunststoffverpackung

	<input checked="" type="checkbox"/>		<input checked="" type="checkbox"/>
Stahl (N/mm2) < 800	<input checked="" type="checkbox"/>	Messing	<input checked="" type="checkbox"/>
Stahl (N/mm2) < 1000	<input checked="" type="checkbox"/>	Bronze	<input type="checkbox"/>
Stahl (N/mm2) < 1200	<input type="checkbox"/>	Kunststoffe	<input type="checkbox"/>
rostfreier Stahl	<input type="checkbox"/>	Gusseisen	<input type="checkbox"/>
Aluminium	<input type="checkbox"/>	Titan legiert	<input type="checkbox"/>

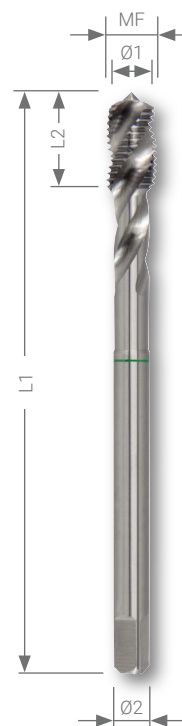

Maschinengewindebohrer mit Überlaufschaft und Rechtsspiralnuten 35° RSP für Sacklochgewinde.

Gewinde Nennmaß MF	Steigung mm	Kernloch Ø1 mm	L1 mm	L2 max. mm	Ø2 mm	HSSE Co 5	
MF 4	0,50	3,50	63,0	10,0	2,8	261 041 E	1
MF 5	0,50	4,50	70,0	12,0	3,5	261 050 E	1
MF 6	0,75	5,20	80,0	14,0	4,5	261 060 E	1
MF 8	1,00	7,00	90,0	22,0	6,0	261 081 E	1
MF 10	1,00	9,00	90,0	20,0	7,0	261 100 E	1
MF 10	1,25	8,80	100,0	24,0	7,0	261 101 E	1
MF 12	1,00	11,00	100,0	20,0	9,0	261 122 E	1
MF 12	1,25	10,80	100,0	22,0	9,0	261 121 E	1
MF 12	1,50	10,50	100,0	22,0	9,0	261 120 E	1
MF 14	1,00	13,00	100,0	20,0	11,0	261 142 E	1
MF 14	1,25	12,80	100,0	22,0	11,0	261 143 E	1
MF 14	1,50	12,50	100,0	22,0	11,0	261 141 E	1
MF 16	1,00	15,00	100,0	20,0	12,0	261 161 E	1
MF 16	1,50	14,50	100,0	22,0	12,0	261 160 E	1
MF 18	1,00	17,00	110,0	25,0	14,0	261 181 E	1
MF 18	1,50	16,50	110,0	25,0	14,0	261 180 E	1
MF 18	2,00	16,00	125,0	34,0	14,0	261 182 E	1
MF 20	1,00	19,00	125,0	25,0	16,0	261 201 E	1
MF 20	1,50	18,50	125,0	25,0	16,0	261 200 E	1
MF 20	2,00	18,00	140,0	34,0	16,0	261 202 E	1
MF 22	1,50	20,50	125,0	25,0	18,0	261 220 E	1
MF 22	2,00	20,00	140,0	34,0	18,0	261 222 E	1
MF 24	1,00	23,00	140,0	28,0	18,0	261 242 E	1
MF 24	1,50	22,50	140,0	28,0	18,0	261 240 E	1
MF 24	2,00	22,00	140,0	28,0	18,0	261 241 E	1
MF 28	1,50	26,50	140,0	28,0	20,0	261 281 E	1
MF 28	2,00	26,00	140,0	28,0	20,0	261 282 E	1
MF 30	1,50	28,50	150,0	28,0	22,0	261 301 E	1
MF 30	2,00	28,00	150,0	28,0	22,0	261 302 E	1

Abbildung schematisch. Kleinere Durchmesser können produktionsbedingt mit Spitze geliefert werden.

■ Hauptanwendung □ Nebenanwendung



Maschinengewindebohrer UNC HSSE-Co 5, geschliffen

Gewinde: amerikanisches Grobgewinde UNC
Flanken: hinterschliffen

Verpackungseinheit: einzeln in Kunststoffverpackung

	<input checked="" type="checkbox"/>		<input checked="" type="checkbox"/>
Stahl (N/mm ²) < 800	<input checked="" type="checkbox"/>	Messing	<input checked="" type="checkbox"/>
Stahl (N/mm ²) < 1000	<input checked="" type="checkbox"/>	Bronze	<input type="checkbox"/>
Stahl (N/mm ²) < 1200	<input type="checkbox"/>	Kunststoffe	<input type="checkbox"/>
rostfreier Stahl	<input type="checkbox"/>	Gusseisen	<input type="checkbox"/>
Aluminium	<input type="checkbox"/>	Titan legiert	<input type="checkbox"/>

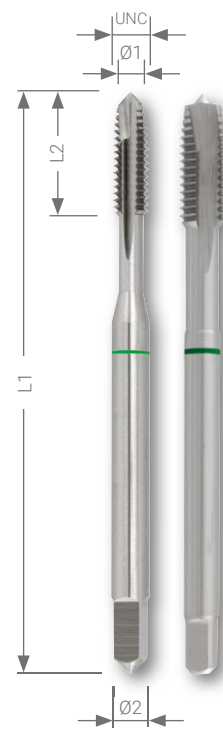

Maschinengewindebohrer mit verstärktem Schaft für Durchgangsgewinde.

Nennmaß UNC	Gangzahl pro Zoll	Kernloch Ø1 mm	L1 mm	L2 mm	Ø2 mm	HSSE Co 5	
Nr. 4	40	2,3	56,0	11,0	3,5	265 040 UNC	1
Nr. 5	40	2,6	56,0	11,0	3,5	265 050 UNC	1
Nr. 6	32	2,8	56,0	13,0	4,0	265 060 UNC	1
Nr. 8	32	3,5	63,0	13,0	4,5	265 080 UNC	1
Nr. 10	24	3,8	70,0	16,0	6,0	265 100 UNC	1
Nr. 12	24	4,5	70,0	16,0	6,0	265 120 UNC	1
1/4	20	5,1	80,0	17,0	7,0	265 014 UNC	1
5/16	18	6,5	90,0	20,0	8,0	265 516 UNC	1
3/8	16	8,0	100,0	22,0	9,0	265 038 UNC	1

Maschinengewindebohrer mit Überlaufschaft für Durchgangsgewinde.

Nennmaß UNC	Gangzahl pro Zoll	Kernloch Ø1 mm	L1 mm	L2 mm	Ø2 mm	HSSE Co 5	
7/16	14	9,3	100,0	22,0	8,0	265 716 UNC	1
1/2	13	10,8	110,0	25,0	9,0	265 012 UNC	1
9/16	12	12,2	110,0	26,0	11,0	265 916 UNC	1
5/8	11	13,5	110,0	27,0	12,0	265 058 UNC	1
3/4	10	16,5	125,0	30,0	14,0	265 034 UNC	1
7/8	9	19,3	140,0	32,0	18,0	265 078 UNC	1
1"	8	22,2	160,0	36,0	18,0	265 010 UNC	1

Abbildung schematisch. Kleinere Durchmesser können produktionsbedingt mit Spitze geliefert werden.



Maschinengewindebohrer UNC HSSE-Co 5, geschliffen

Gewinde: amerikanisches Grobgewinde UNC
Flanken: hinterschliffen

Verpackungseinheit: einzeln in Kunststoffverpackung

Stahl (N/mm2) < 800	■	Messing	■
Stahl (N/mm2) < 1000	■	Bronze	□
Stahl (N/mm2) < 1200		Kunststoffe	□
rostfreier Stahl	□	Gusseisen	□
Aluminium	□	Titan legiert	

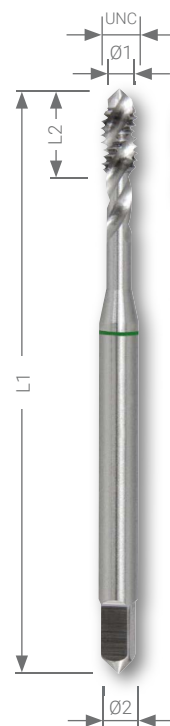

Maschinengewindebohrer mit verstärktem Schaft und Rechtsspiralnuten 35° RSP für Sacklochgewinde.

Nennmaß UNC	Gangzahl pro Zoll	Kernloch Ø1 mm	L1 mm	L2 mm	Ø2 mm	HSSE Co 5	
Nr. 4	40	2,3	56,0	7,0	3,5	266 040 UNC	1
Nr. 5	40	2,6	56,0	7,0	3,5	266 050 UNC	1
Nr. 6	32	2,8	56,0	8,0	4,0	266 060 UNC	1
Nr. 8	32	3,5	63,0	8,0	4,5	266 080 UNC	1
Nr. 10	24	3,8	70,0	10,0	6,0	266 100 UNC	1
Nr. 12	24	4,5	70,0	10,0	6,0	266 120 UNC	1
1/4	20	5,1	80,0	13,0	7,0	266 014 UNC	1
5/16	18	6,5	90,0	14,0	8,0	266 516 UNC	1
3/8	16	8,0	100,0	16,0	10,0	266 038 UNC	1

Maschinengewindebohrer mit Überlaufschaft und Rechtsspiralnuten 35° RSP für Sacklochgewinde.

Nennmaß UNC	Gangzahl pro Zoll	Kernloch Ø1 mm	L1 mm	L2 mm	Ø2 mm	HSSE Co 5	
7/16	14	9,3	100,0	17,0	8,0	266 716 UNC	1
1/2	13	10,8	110,0	20,0	9,0	266 012 UNC	1
9/16	12	12,2	110,0	20,0	11,0	266 916 UNC	1
5/8	11	13,5	110,0	22,0	12,0	266 058 UNC	1
3/4	10	16,5	125,0	25,0	14,0	266 034 UNC	1
7/8	9	19,3	140,0	27,0	18,0	266 078 UNC	1
1"	8	22,2	160,0	30,0	18,0	266 010 UNC	1

Abbildung schematisch. Kleinere Durchmesser können produktionsbedingt mit Spitze geliefert werden.



Maschinengewindebohrer UNF HSSE-Co 5, geschliffen

Gewinde: amerikanisches Feingewinde UNF
Flanken: hinterschliffen

Verpackungseinheit: einzeln in Kunststoffverpackung

Stahl (N/mm2) < 800	■	Messing	■
Stahl (N/mm2) < 1000	■	Bronze	□
Stahl (N/mm2) < 1200		Kunststoffe	□
rostfreier Stahl	□	Gusseisen	□
Aluminium	□	Titan legiert	

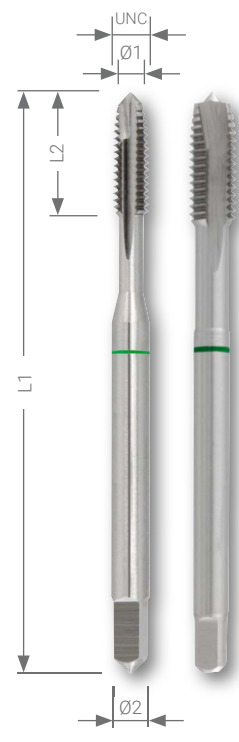

Maschinengewindebohrer mit verstärktem Schaft für Durchgangsgewinde.

Nennmaß UNF	Gangzahl pro Zoll	Kernloch Ø1 mm	L1 mm	L2 mm	Ø2 mm	HSSE Co 5	
Nr. 4	48	2,40	56,0	11,0	3,5	265 040 UNF	1
Nr. 5	44	2,70	56,0	11,0	3,5	265 050 UNF	1
Nr. 6	40	2,95	56,0	13,0	4,0	265 060 UNF	1
Nr. 8	36	3,50	63,0	13,0	4,5	265 080 UNF	1
Nr. 10	32	4,10	70,0	16,0	6,0	265 100 UNF	1
Nr. 12	28	4,60	70,0	16,0	6,0	265 120 UNF	1
1/4	28	5,50	80,0	17,0	7,0	265 014 UNF	1
5/16	24	6,60	90,0	17,0	8,0	265 516 UNF	1
3/8	24	8,50	100,0	18,0	10,0	265 038 UNF	1

Maschinengewindebohrer mit Überlaufschaft für Durchgangsgewinde.

Nennmaß UNF	Gangzahl pro Zoll	Kernloch Ø1 mm	L1 mm	L2 mm	Ø2 mm	HSSE Co 5	
7/16	20	9,90	100,0	22,0	8,0	265 716 UNF	1
1/2	20	11,50	100,0	22,0	9,0	265 012 UNF	1
9/16	18	12,90	100,0	22,0	11,0	265 916 UNF	1
5/8	18	14,50	100,0	22,0	12,0	265 058 UNF	1
3/4	16	17,50	110,0	25,0	14,0	265 034 UNF	1
7/8	14	20,50	140,0	26,0	18,0	265 078 UNF	1
1"	12	23,25	150,0	28,0	18,0	265 010 UNF	1

Abbildung schematisch. Kleinere Durchmesser können produktionsbedingt mit Spitze geliefert werden.



Maschinengewindebohrer UNF HSSE-Co 5, geschliffen

Gewinde: amerikanisches Feingewinde UNF
Flanken: hinterschliffen

Verpackungseinheit: einzeln in Kunststoffverpackung

	<input checked="" type="checkbox"/>		<input checked="" type="checkbox"/>
Stahl (N/mm2) < 800	<input checked="" type="checkbox"/>	Messing	<input checked="" type="checkbox"/>
Stahl (N/mm2) < 1000	<input checked="" type="checkbox"/>	Bronze	<input type="checkbox"/>
Stahl (N/mm2) < 1200	<input type="checkbox"/>	Kunststoffe	<input type="checkbox"/>
rostfreier Stahl	<input type="checkbox"/>	Gusseisen	<input type="checkbox"/>
Aluminium	<input type="checkbox"/>	Titan legiert	<input type="checkbox"/>

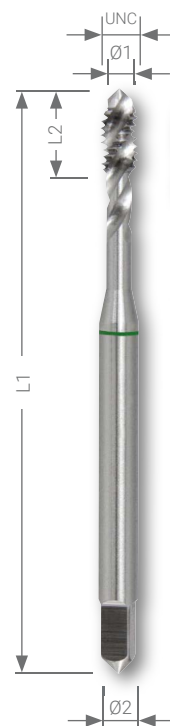

Maschinengewindebohrer mit verstärktem Schaft und Rechtsspiralnuten 35° RSP für Sacklochgewinde.

Nennmaß UNF	Gangzahl pro Zoll	Kernloch Ø1 mm	L1 mm	L2 mm	Ø2 mm	HSSE Co 5	
Nr. 4	48	2,40	56,0	5,5	3,5	266 040 UNF	1
Nr. 5	44	2,70	56,0	6,0	3,5	266 050 UNF	1
Nr. 6	40	2,95	56,0	7,0	4,0	266 060 UNF	1
Nr. 8	36	3,50	63,0	7,5	4,5	266 080 UNF	1
Nr. 10	32	4,10	70,0	8,0	6,0	266 100 UNF	1
Nr. 12	28	4,60	70,0	9,0	6,0	266 120 UNF	1
1/4	28	5,50	80,0	10,0	7,0	266 014 UNF	1
5/16	24	6,90	90,0	10,0	8,0	266 516 UNF	1
3/8	24	8,50	100,0	10,0	10,0	266 038 UNF	1

Maschinengewindebohrer mit Überlaufschaft und Rechtsspiralnuten 35° RSP für Sacklochgewinde.

Nennmaß UNF	Gangzahl pro Zoll	Kernloch Ø1 mm	L1 mm	L2 mm	Ø2 mm	HSSE Co 5	
7/16	20	9,90	100,0	13,0	8,0	266 716 UNF	1
1/2	20	11,50	100,0	13,0	9,0	266 012 UNF	1
9/16	18	12,90	100,0	15,0	11,0	266 916 UNF	1
5/8	18	14,50	100,0	15,0	12,0	266 058 UNF	1
3/4	16	17,50	110,0	17,0	14,0	266 034 UNF	1
7/8	14	20,50	140,0	17,0	18,0	266 078 UNF	1
1"	12	23,25	150,0	20,0	18,0	266 010 UNF	1

Abbildung schematisch. Kleinere Durchmesser können produktionsbedingt mit Spitze geliefert werden.



Maschinengewindebohrer PG HSS, geschliffen

Maschinengewindebohrer mit Überlaufschaft, für Durchgangsgewinde.

Gewinde: Stahlpanzerrohrgewinde DIN 40 430
 Flanken: hinterschliffen

Verpackungseinheit: einzeln in Kunststoffverpackung

	<input type="checkbox"/>		<input type="checkbox"/>
Stahl (N/mm ²) < 800	<input checked="" type="checkbox"/>	Messing	<input checked="" type="checkbox"/>
Stahl (N/mm ²) < 1000	<input type="checkbox"/>	Bronze	<input type="checkbox"/>
Stahl (N/mm ²) < 1200	<input type="checkbox"/>	Kunststoffe	<input type="checkbox"/>
rostfreier Stahl	<input type="checkbox"/>	Gusseisen	<input type="checkbox"/>
Aluminium	<input type="checkbox"/>	Titan legiert	<input type="checkbox"/>

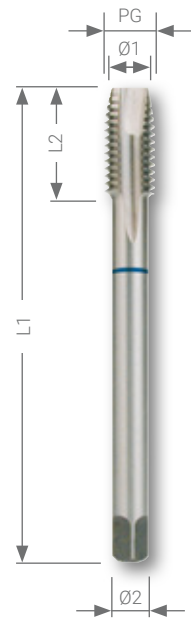

Nennmaß PG	Gangzahl pro Zoll	Kernloch Ø1 mm	L1 mm	L2 mm	Ø2 mm	HSS	
PG 7	20	11,35	70,0	22,0	9,0	264 007	1
PG 9	18	13,95	70,0	22,0	12,0	264 009	1
PG 11	18	17,35	80,0	22,0	14,0	264 011	1
PG 13,5	18	19,15	80,0	22,0	16,0	264 135	1
PG 16	18	21,25	80,0	22,0	18,0	264 016	1
PG 21	16	26,95	90,0	22,0	22,0	264 021	1
PG 29	16	35,60	100,0	25,0	28,0	264 029	1
PG 36	16	45,60	140,0	40,0	36,0	264 036	1
PG 42	16	52,60	140,0	40,0	40,0	264 042	1
PG 48	16	57,90	160,0	40,0	45,0	264 048	1



Muttergewindebohrer M DIN 357 HSS, geschliffen

Langer Schaft zur Aufnahme mehrerer geschnittener Muttern.

Anschnitt: ca. 2/3 der Gewindelänge
 Gewinde: metrisch DIN ISO 13
 Flanken: hinterschliffen

Verpackungseinheit: einzeln in Kunststoffverpackung

Nennmaß M	Steigung mm	Kernloch Ø1 mm	L1 mm	L2 mm	Ø2 mm	HSS	
M 3	0,50	2,5	70,0	22,0	2,2	243 030	1
M 4	0,70	3,3	90,0	25,0	2,8	243 040	1
M 5	0,80	4,2	100,0	28,0	3,5	243 050	1
M 6	1,00	5,0	110,0	32,0	4,5	243 060	1
M 8	1,25	6,8	125,0	40,0	6,0	243 080	1
M 10	1,50	8,5	140,0	45,0	7,0	243 100	1
M 12	1,75	10,2	180,0	50,0	9,0	243 120	1
M 14	2,00	12,0	200,0	56,0	11,0	243 140	1
M 16	2,00	14,0	200,0	63,0	12,0	243 160	1
M 18	2,50	15,5	220,0	63,0	14,0	243 180	1
M 20	2,50	17,5	250,0	70,0	16,0	243 200	1
M 22	2,50	19,5	280,0	80,0	18,0	243 220	1
M 24	3,00	21,0	280,0	80,0	18,0	243 240	1



Abbildung schematisch. Kleinere Durchmesser können produktionsbedingt mit Spitze geliefert werden.



Gewindeformer DIN 2174 HSSE-Co 5 nitriert VAP und HSSE-Co 5 TiAIN, geschliffen

Gewindeformer mit verstärktem Schaft für Durchgangsgewinde und Sacklochgewinde.

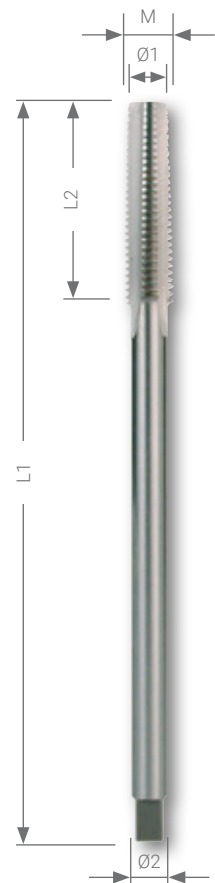
Gewinde: metrisch DIN ISO 13
 Flanken: hinterschliffen

Durch spanloses Formen keine Unterbrechung des Faserverlaufs im Material.
 Durch die Verformung entstehen sehr steife Gewindegänge.
 Gleichbleibende Genauigkeit auch bei hoher Produktivität.



HSSE-Co 5 nitriert VAP

Gewindeformer aus kobaltlegiertem, nitriertem und vaporisiertem Hochleistungs-Schnellarbeitsstahl. Geeignet für unlegierte und legierte Stähle bis 1000 N/mm² Festigkeit und NE-Metalle.

HSSE-Co 5 TiAIN

Gewindeformer aus kobaltlegiertem Hochleistungs-Schnellarbeitsstahl mit Titan-Aluminium-Nitrid-Beschichtung. Geeignet für unlegierte und legierte Stähle über 1000 N/mm² Festigkeit, hochchromlegierte Stähle wie V2A und NE-Metalle.

Verpackungseinheit: einzeln in Kunststoffverpackung



	<input checked="" type="checkbox"/>	<input checked="" type="checkbox"/>
Stahl (N/mm ²) < 800	<input checked="" type="checkbox"/>	<input checked="" type="checkbox"/>
Stahl (N/mm ²) < 1000	<input checked="" type="checkbox"/>	<input checked="" type="checkbox"/>
Stahl (N/mm ²) < 1200	<input type="checkbox"/>	<input checked="" type="checkbox"/>
rostfreier Stahl	<input type="checkbox"/>	<input checked="" type="checkbox"/>
Aluminium	<input type="checkbox"/>	<input type="checkbox"/>

	<input checked="" type="checkbox"/>	<input checked="" type="checkbox"/>
Messing	<input checked="" type="checkbox"/>	<input checked="" type="checkbox"/>
Bronze	<input type="checkbox"/>	<input type="checkbox"/>
Kunststoffe	<input type="checkbox"/>	<input type="checkbox"/>
Gusseisen	<input type="checkbox"/>	<input type="checkbox"/>
Titan legiert	<input type="checkbox"/>	<input type="checkbox"/>

Gewinde Nennmaß M	Steigung mm	Kernloch Ø1 mm	L1 mm	L2 mm	Schaft-Ø2 mm	HSSE Co5	HSSE Co5 TiAIN	
M 3	0,50	2,80	56,0	11,0	3,5	271 003 N	271 003 F	1
M 4	0,70	3,70	63,0	13,0	4,5	271 004 N	271 004 F	1
M 5	0,80	4,65	70,0	16,0	6,0	271 005 N	271 005 F	1
M 6	1,00	5,55	80,0	19,0	6,0	271 006 N	271 006 F	1
M 8	1,25	7,45	90,0	22,0	8,0	271 008 N	271 008 F	1
M 10	1,50	9,35	100,0	24,0	10,0	271 010 N	271 010 F	1
M 12	1,75	11,20	110,0	28,0	9,0	271 012 N	271 012 F	1

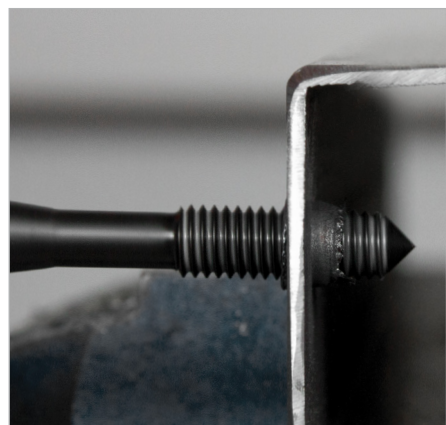

Allgemeine Informationen:

Gewindeschneiden
 Faserverlauf beim Gewindeschneiden

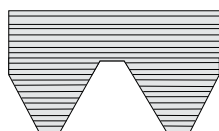

Gewindeformen
 Faserverlauf beim Gewindeformen

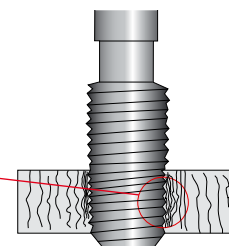
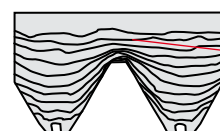



Kombi-Maschinengewindebohrer-Bit "Lang" und Bit "Kurz" HSS und HSS-TiN, geschliffen

Kombi-Maschinengewindebohrer mit Bit-Schaft für Kernloch und Durchgangsgewinde.

Flanken: hinterschliffen
Schaft: 6,35 x 27,0 mm

Der Kombi-Gewindebohrer eignet sich ideal für die Blechbearbeitung mit Rechts-/Linkslauf Akkubohrmaschinen. Das Gewinde wird in einem Arbeitsgang geschnitten, ohne Werkzeugwechsel. Ein Spiralbohrer ist dem Gewinde vorgesetzt.

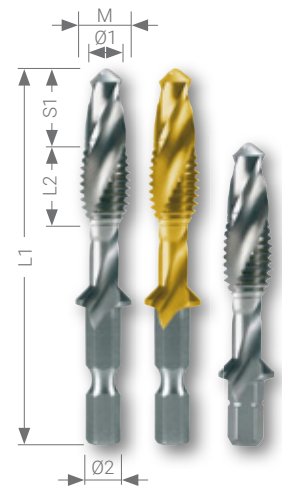

In einem Arbeitsgang:

- ✓ Kernlochbohren mit Spiralbohrer
- ✓ Gewinde schneiden
- ✓ Gewinde entgraten
- ✓ Gewinde säubern (beim Rücklauf)

HSS

Geeignet für unlegierte und legierte Stähle bis 600 N/mm² Festigkeit, Temperguß und NE-Metalle.

HSS-TiN

Geeignet für unlegierte und legierte Stähle bis 900 N/mm² Festigkeit, Temperguß und NE-Metalle.

Verpackungseinheit: einzeln in Kunststoffverpackung



270...
270... T



R 270...
R 270... T

Stahl (N/mm ²) < 800	<input type="checkbox"/>	<input checked="" type="checkbox"/>
Stahl (N/mm ²) < 1000	<input type="checkbox"/>	<input type="checkbox"/>
Stahl (N/mm ²) < 1200	<input type="checkbox"/>	<input type="checkbox"/>
rostfreier Stahl	<input type="checkbox"/>	<input type="checkbox"/>
Aluminium	<input checked="" type="checkbox"/>	<input type="checkbox"/>

Messing	<input checked="" type="checkbox"/>	<input checked="" type="checkbox"/>
Bronze	<input type="checkbox"/>	<input type="checkbox"/>
Kunststoffe	<input checked="" type="checkbox"/>	<input type="checkbox"/>
Gusseisen	<input type="checkbox"/>	<input type="checkbox"/>
Titan legiert	<input type="checkbox"/>	<input type="checkbox"/>

Kombi-Maschinengewindebohrer-Bit "Lang" HSS und HSS-TiN, geschliffen

Gewinde Nennmaß M	Steigung mm	L1 mm	S1 mm	L2 mm	Ø1 mm	Ø2 mm			
M 3	0,50	51,0	5,0	7,0	2,5	7,0	270 014	270 014 T	1
M 4	0,70	54,0	6,0	8,5	3,3	7,0	270 015	270 015 T	1
M 5	0,80	57,0	7,0	10,0	4,2	7,0	270 016	270 016 T	1
M 6	1,00	60,0	8,0	12,0	5,0	7,0	270 017	270 017 T	1
M 8	1,25	68,0	11,0	15,0	6,8	9,5	270 018	270 018 T	1
M 10	1,50	75,0	15,0	17,0	8,5	11,5	270 019	270 019 T	1

Kombi-Maschinengewindebohrer-Bit "Kurz" HSS und HSS-TiN, geschliffen

Gewinde Nennmaß M	Steigung mm	L1 mm	S1 mm	L2 mm	Ø1 mm	Ø2 mm			
M 3	0,50	36,0	5,0	6,0	2,5	7,2	R 270 014	R 270 014 T	1
M 4	0,70	39,0	6,0	8,0	3,3	7,2	R 270 015	R 270 015 T	1
M 5	0,80	41,0	7,0	9,0	4,2	7,2	R 270 016	R 270 016 T	1
M 6	1,00	44,0	8,0	11,0	5,0	7,2	R 270 017	R 270 017 T	1
M 8	1,25	51,0	11,0	14,0	6,8	8,8	R 270 018	R 270 018 T	1
M 10	1,50	59,0	15,0	15,0	8,5	11,0	R 270 019	R 270 019 T	1



Kombi-Maschinengewindebohrer-Sätze „Lang“ HSS und HSS-TiN in Industriekassette

7-teiliger Kombi-Maschinengewindebohrer-Satz „Lang“ 6 Kombi-Maschinengewindebohrer M 3 - M 4 - M 5 - M 6 - M 8 - M 10 + 1 Sechskantmagnethalter	270 020	270 020 T



Kombi-Maschinengewindebohrer-Sätze „Kurz“ HSS und HSS-TiN in Industriekassette

7-teiliger Kombi-Maschinengewindebohrer-Satz „Kurz“ 6 Kombi-Maschinengewindebohrer M 3 - M 4 - M 5 - M 6 - M 8 - M 10 + 1 Sechskantmagnethalter	R 270 020	R 270 021 T



Sechskantmagnethalter

Verpackungseinheit: einzeln in Kunststoffverpackung

	Artikel-Nr.	
Sechskantmagnethalter	270 013	1





Gewindeausdreh-Sätze in Kunststoffkassette

21-teiliger Gewindeausdreh-Satz 4 Spiralbohrer, 4 Ausdrehstifte, 4 Ausdrehmuttern und 9 Bohrbuchsen	244 150	
25-teiliger Gewindeausdreh-Satz 5 Spiralbohrer, 5 Ausdrehstifte, 5 Ausdrehmuttern und 10 Bohrbuchsen	244 151	



1 Hochleistungsspiralbohrer DIN 338 HSS-G, geschliffen

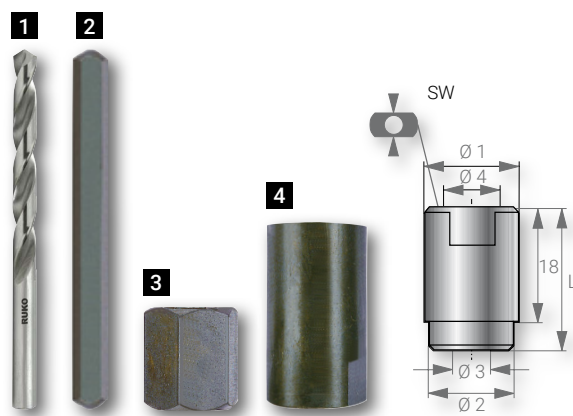

geschliffene Ausführung, passgenau auf die Bohrbuchsen abgestimmt

Ø mm	Ø Zoll	für Stiftgröße	Länge mm		
3,2	1/8	1 - 4	65,0	214 032	1
4,8	3/16	5 - 7	86,0	214 048	1
6,4	1/4	8	101,0	214 064	1
8,0	5/16	9	117,0	214 080	1
8,7	11/32	10	125,0	214 087	1





2 Ausdrehstifte

aus Spezial-Profilstahl, gehärtet, brüniert

Größe	für Gewinde	Ø mm	Ø Zoll	Länge mm		
1	M 5 - M 6	3,2	1/8	60,0	244 001	1
2	M 7 - M 8	4,8	3/16	70,0	244 002	1
3	M 9 - M 10	6,4	1/4	78,0	244 003	1
4	M 12	8,0	5/16	83,0	244 004	1
5	M 14 - M 16	8,7	11/32	94,0	244 005	1



3 Ausdrehmutter

mit Spezial-Innenprofil, gehärtet, brüniert

Größe	für Stiftgröße	Schlüsselweite mm	Länge mm		
1	1	10,0	16,0	244 032	1
2	2	11,0	16,0	244 046	1
3	3	13,0	16,0	244 064	1
4	4	14,0	16,0	244 080	1
5	5	17,0	16,0	244 087	1

4 Bohrbuchsen

abgesetzt, gehärtet, brüniert, für tieferliegende Schraubenreste (Ø1 + Ø 2), für hervorstehende Schraubenreste (Ø 4)

Größe	Ø 1 mm	Ø 2 mm	Ø 3 mm	Ø 4 mm	Ø 3 Zoll	Ø 4 Zoll	SW mm	L mm		
1	7,0	6,0	3,2	5,0	1/8	3/16	6,0	30,0	244 101	1
2	8,0	7,0	3,2	6,0	1/8	—	7,0	30,0	244 102	1
3	9,0	—	3,2	7,0	1/8	1/4	8,0	30,0	244 103	1
4	10,0	—	3,2	8,0	1/8	5/16	9,0	30,0	244 104	1
5	11,0	—	4,8	8,0	3/16	5/16	9,0	30,0	244 105	1
6	12,0	—	4,8	9,0	3/16	—	10,0	30,0	244 106	1
7	13,0	—	4,8	10,0	3/16	1/8	11,0	30,0	244 107	1
8	14,0	—	6,4	11,0	1/4	7/16	12,0	30,0	244 108	1
9	15,0	—	8,0	12,0	5/16	—	13,0	30,0	244 109	1
10	17,0	16,0	8,7	14,0	11/32	—	14,0	30,0	244 110	1

Anwendung

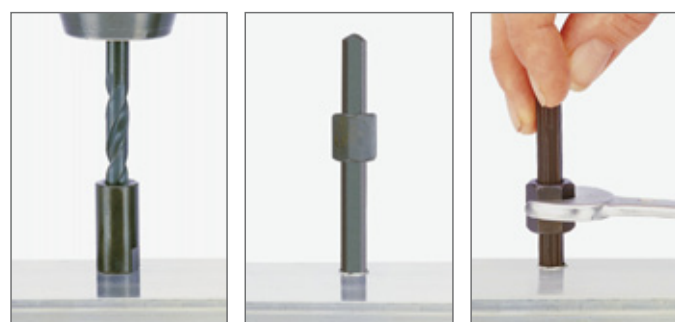

- Nr. 1
abgebrochenes Gewinde mit Bohrbuchse anbohren
- Nr. 2
Ausdrehstift einschlagen und Ausdrehmutter bis unten aufschieben
- Nr. 3
gleichmäßig ausdrehen ohne zu verkanten