

LABORATORY POWER SUPPLY

JT-RD6006



1. GENERAL INFORMATION

Dear customer,
 thank you very much for choosing our product.
 In following, we will introduce you to what to observe while starting up and using this product.
 Should you encounter any unexpected problems during use, please do not hesitate to contact us.

The RD6006 is a constant voltage and constant current DC power supply which can convert voltages down.
 It is very easy to handle and the adjustment can either be made by keypad or by the encoder of the or even both.
 It is easy and quick to store and recall data and the RD6006 is very connectable with a PC or via WIFI with a handheld device in addition that you can use an App for control. On the 2.4 " colour screen you can read out many values and additional information.

SAFETY INSTRUCTIONS

Our product is suitable for up to 70 Volt DC. Working with voltage over 60 V DC is reserved for trained electricians, because of the hazard of an electric shock which may cause serious injuries or death. Non-electricians have to use a voltage source below 60 Volt DC.

Power source input interface must be connected to 6-70V constant DC power source. The external sensor cable (as shown on right) must be connected to the external temperature sensor interface.



The fan interface cannot be connected to other fans. When the output current is higher than 4A or the system temperature higher than 45 °C, the fan start to work, when the temperature is less than 40°C and output current lower than 3.9A, the fan will stop working.

When the system temperature is higher than 80°C, the output will be shut down because of OTP. CR1220 is the clock battery, communication interface is a special interface, please don't connect to other modules or cables.

Note: This instruction is corresponding to firmware V1.25.

2. TECHNICAL SPECIFICATIONS

Display	2.4 " colour LCD
Input voltage range	6 - 70 V
Output voltage range	0 - 60 V
Output current range	0 - 6 A
Output power range	0 - 360 W
Input voltage accuracy	± 1 % + 5 digits
Output voltage accuracy	± 0.3 % + 3 digits
Output current accuracy	± 0.5% + 5 digits
Battery voltage measurement accuracy	± 0.5% + 3 digits
Input voltage measurement resolution	0.01 V
Output voltage measurement resolution	0.01 V
Current setting measurement resolution	0.001 A
Battery voltage measurement resolution	0.01 V
Constant voltage mode response time	2 ms (at 0.1 - 4 A load)
Constant voltage mode load regulation	± 0.1 % + 2 digits
Constant current mode load regulation	± 0.1 % + 3 digits
Capacity measurement range	0 - 9999.99 Ah
Energy measurement range	0 - 9999.99 Wh
Capacity and Energy statistical error	± 2 %
Output ripple	typical 100mV VPP
Sensor temperature detection range	-10 - 100°C / 0- 200 ° F
Sensor temperature detection accuracy	± 3° C / ± 6 °F
Working mode	Buck mode
Voltage drop	> 1V and > 10 %
Screen brightness setting	0 - 5 Level , total 6 level
Working temperature range	- 10° - 40 ° C

3. SCREEN OVERVIEW

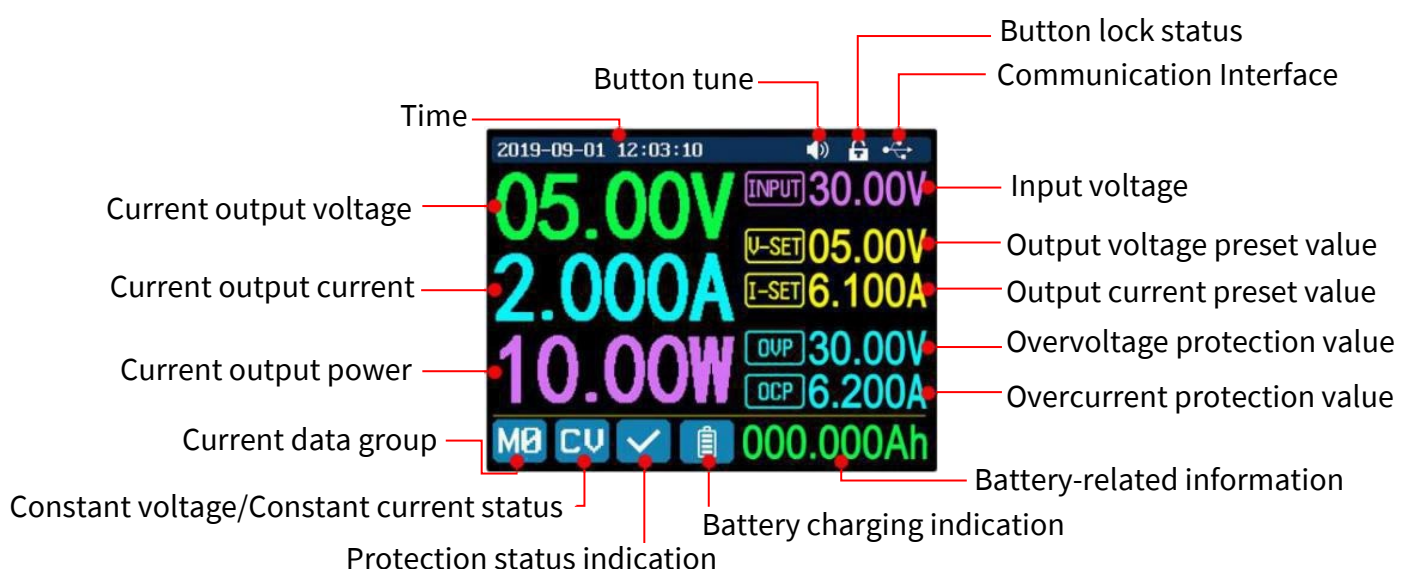

4. DEVICE OVERVIEW

4.1. Front Panel:

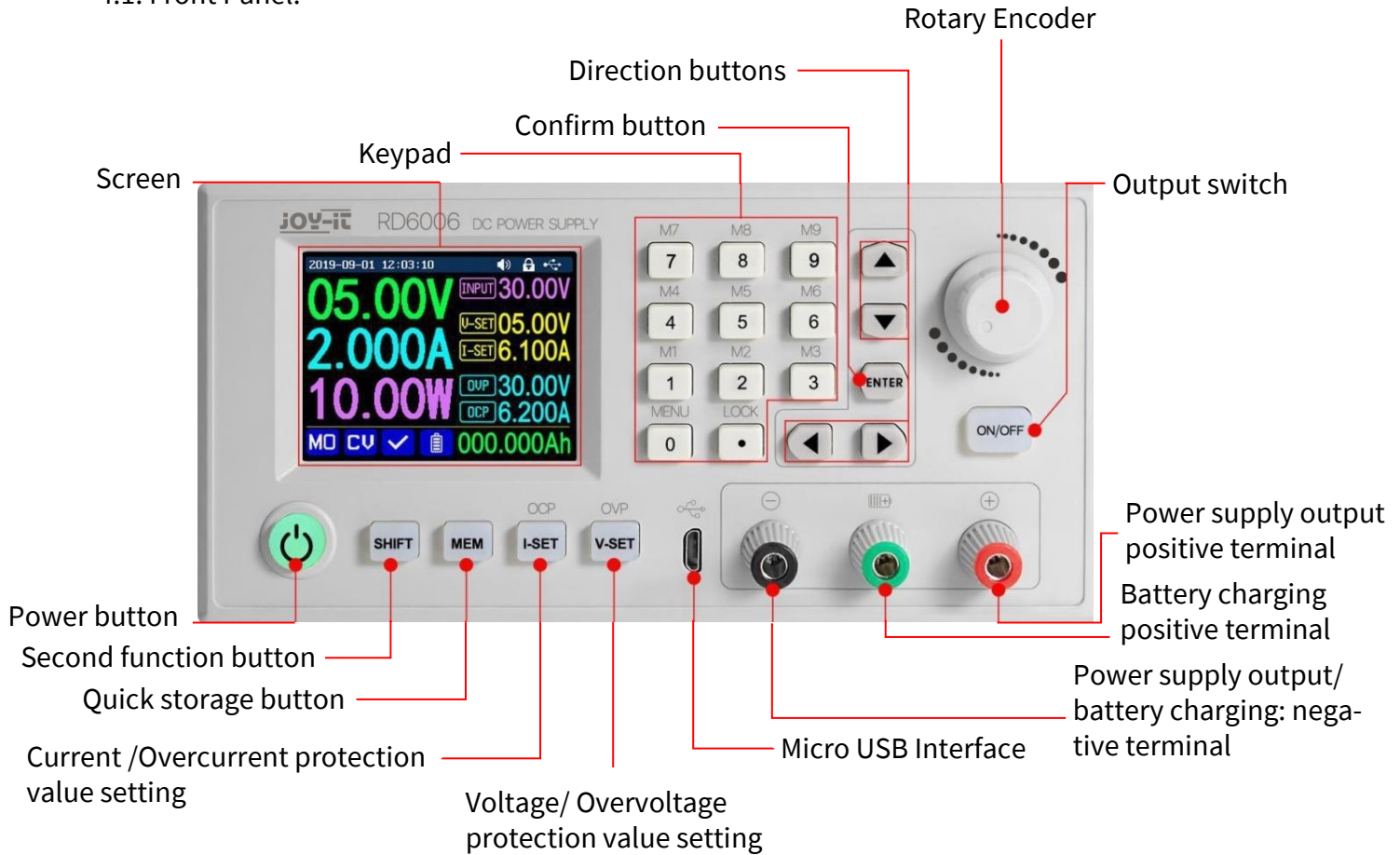

4.2. Back:

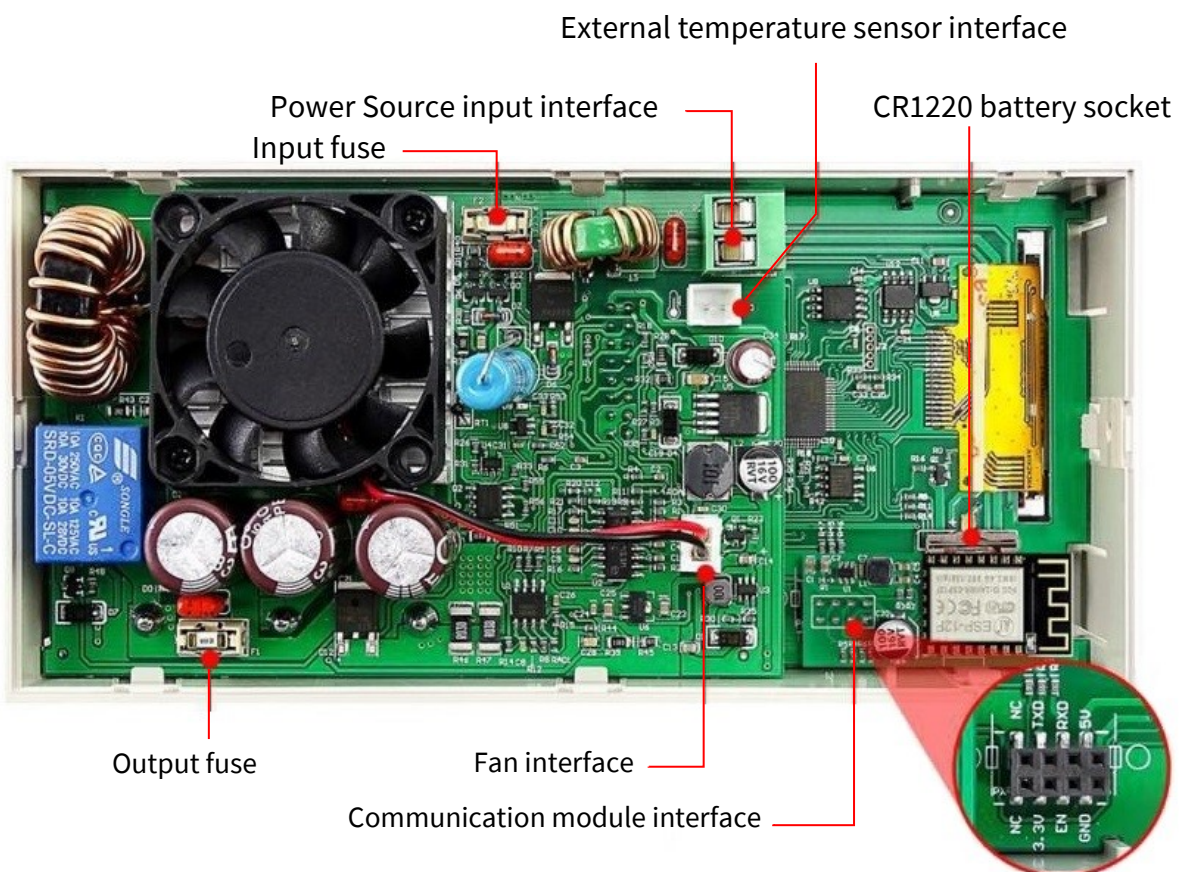

5. MENU INTRODUCTION

1. Operation Menu

In the menu operation, the icon in red or cursor is the currently selected menu; the icon in blue is the unselected menu; press **ENTER** to confirm; press the encoder to cancel or return; press the direction key to move the cursor or switch menu; rotate the encoder to change the setting; the settings will be automatically saved when returning from the menu page.

Press and hold the 0 button and power on to restore the factory settings; press and hold the 1 button and power on to restore the factory calibration value; press and hold **ENTER** and power on to enter the boot mode.

2. Battery Charging mode

After power-on, at battery related information display area, external temperature, capacity and energy will loop display. When there is output current: electrical charge, energy are automatically accumulated, and automatically cleared after shutdown. The green terminal is connected to the positive pole of the battery and the black terminal is connected to the negative pole of the battery. After the battery is correctly connected, the battery charging indicator turns red and the battery is connected. Press **ON/OFF** to start charging, the battery charging indicator turns green. When the actual output current is lower than 10mA, the output will be shut down automatically. Battery with protection board may not be charged. The charging voltage and current should be set on your own. It is strongly recommended to use the original charger to charge the battery.

There is a risk of fire and explosion during the charging process. Non-professionals should not operate!



3. Main Page Output Voltage and Output Current Setting

Press '**I-SET**' button to set the output current value, you can use encoder to adjust the output value directly, press the direction button to move the cursor.

Of course you can use keypad to set the value, and press '**ENTER**' to confirm.

If you set the wrong value, you can press the encoder to cancel.

Press '**V-SET**' button to set the output voltage value, the operation method is similar to output current setting. Press '**SHIFT**+'**I-SET**' button or '**SHIFT**+'**V-SET**' button to set the over current protection/ over voltage protection value. The operation method is similar to output current setting. M0 is the default data group when JT-RD6006 is powered on, manually modify the settings and automatically remember to M0 after confirmation.

4. Data Group Quick Storage and Callout

Press '**MEM**' + keypad button 1-9, you can store the output voltage value, output current value, over voltage protection value, over current protection value into the corresponding data group (as shown above), then press '**ENTER**' to confirm, or press the encoder to cancel. Press '**SHIFT**' + keypad button 1-9 to quick call out the saved data (as shown above). Press '**ENTER**' to confirm, or press the encoder to cancel.

5. Keypad lock and unlock

Press '**SHIFT**'+'**LOCK**' to lock or unlock the keyboard. And the keypad will be automatically locked when communication starts,

there will be  displayed on the top (can not unlock manually), and the keypad will be automatically unlocked when the connection disconnected manually.

There will be  displayed, the keypad will be automatically unlocked when the connection disconnected abnormally, and the power-off button can be used when the keypad is locked.

6. System Setting

Press '**SHIFT**'+'**MENU**' to enter the system setting menu as shown on the right, press '**ENTER**' to enter the menu, press direction button to select option, the option in red is the option be chosen, rotate the encoder to change setting.

Turn on the '**Call OK**', a confirmation window will pop up when you quick call out a data group. If you turn it off, the setting values will be modified directly when you call out a data group.

Turn on the '**Call out**', the output will be turn on automatically when you call out a data group. If you turn it off, the output will keep the previous status.

Turn on the '**Power On**', it will turn on the output automatically when start. If you turn it off, the output will keep OFF status when started.

Turn on the '**Beeper**', you will hear button tune when press the button, and there will be  on the top.

If you turn it off, there will not be button tune when press the button, and there will be on  the top.

Turn on the "**Logo**", it will display Logo first and then enter the main page when boot RD6006. If you turn it off, you will enter the main page directly.

The system language supports Simplified Chinese and English for the time being. The screen brightness can be set from level 0 to level 5.

The communication interface can be set to USB, Wi-Fi or TTL, **USB** interface is the Micro-USB interface on the front panel interface, you can see the  on the top when communication starts.

Wi-Fi interface is the Wi-Fi module connected to the communication interface, you can see the  on the top when communication starts (connect mobile phone by Wi-Fi, but you need to choose Wi-Fi interface first, Wi-Fi module can not be installed or removed when RD6006 is powered on), TTL is not available for the time being.

When the interface is changed, you need to reboot RD6006 to apply the modification. The baud rate can be set 9600/19200/38400/57600/115200 under USB mode; The Baud rate under Wi-Fi is fixed at 115200. Device address can be set from 001-255. You can set the date and time by rotating the encoder, the setting will be saved immediately after modification. Please do not set a wrong time, it may cause the date to not be automatically accumulated. Press the encoder to return, and the set value will be saved automatically.

Measure is the refresh rate of read back voltage and current in the main page, you can set it to low, middle and high. Press encoder potentiometer to return and it will

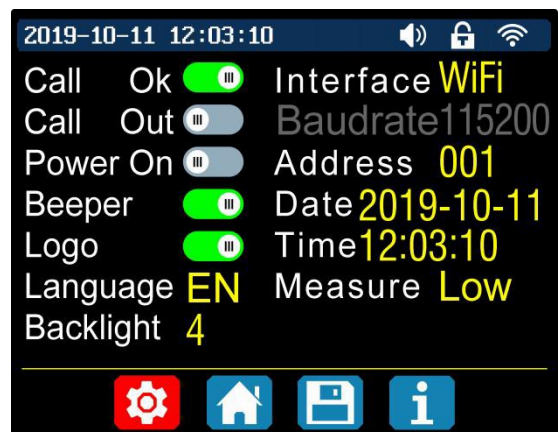

be automatically saved.

7. Main Page Style setting

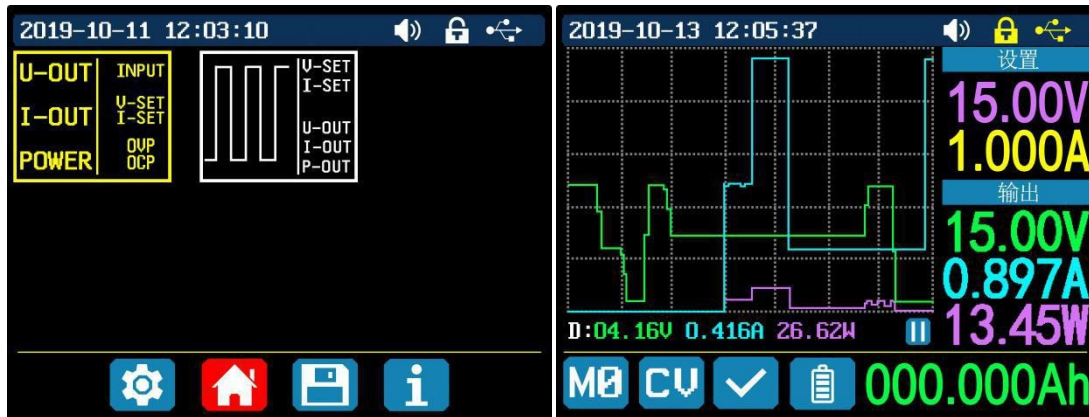

You can press '**SHIFT**' + '**MENU**' to enter the system setting menu, and then press the right button to enter the main page style setting menu as shown above. Press **ENTER** and then use direction button to set classic style or curve style. The pattern in red is the style be chosen. The classic style is the system default style, and the large font shows the voltage, current and power. The curve style is as shown above, the color of the three curves corresponds to the output voltage, current and power. **D** is the scale of the ordinate, Press '**ENTER**' to start or pause the curve, and the rotate encoder potentiometer to scale the ordinate of the curve.

8. Storage Data Setting

You can press '**SHIFT**' + '**MENU**' to enter the system setting menu, and then press the right button twice to enter the data storage setting menu as shown below, press **ENTER** to enter the setting menu, the icon in red is the chosen data group, press the direction button to select data group number. Press '**I-SET**' button to set the storage output current value, then rotate the encoder potentiometer the adjust the output value, press the direction button to move the cursor. You can also set the value with keypad, press **ENTER** to confirm. If you set the wrong value, you can press the encoder potentiometer to cancel. Press '**V-SET**' button to set the storage output voltage value, the operation method is similar to storage output current setting. Press '**SHIFT**' + '**I-SET**' button or '**SHIFT**' + '**V-SET**' button to set the storage over current protection/ storage over voltage protection value. The operation method is similar to storage output current value setting. Press **Encoder Potentiometer** to return, and the data will be automatically saved.

9. System Information

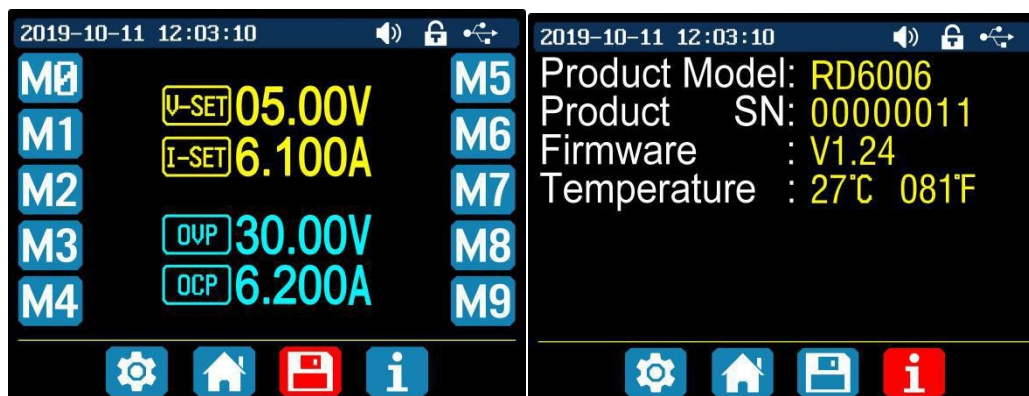

You can press '**SHIFT**' + '**MENU**' to enter the system setting menu, and then press the right button three times to enter the system information menu as shown above. You can view the SN number, firmware version and system temperature here.

6. ADDITIONAL INFORMATION

Our information and take-back obligations according to the Electrical and Electronic Equipment Act (ElektroG)



Symbol on electrical and electronic equipment:

This crossed-out dustbin means that electrical and electronic appliances do not belong in the household waste. You must return the old appliances to a collection point.

Before handing over waste batteries and accumulators that are not enclosed by waste equipment must be separated from it.

Return options:

As an end user, you can return your old device (which essentially fulfils the same function as the new device purchased from us) free of charge for disposal when you purchase a new device.

Small appliances with no external dimensions greater than 25 cm can be disposed of in normal household quantities independently of the purchase of a new appliance.

Possibility of return at our company location during opening hours:

Simac GmbH, Pascalstr. 8, D-47506 Neukirchen-Vluyn, Germany

Possibility of return in your area:

We will send you a parcel stamp with which you can return the device to us free of charge. Please contact us by e-mail at Service@joy-it.net or by telephone.

Information on packaging:

If you do not have suitable packaging material or do not wish to use your own, please contact us and we will send you suitable packaging.

7. SUPPORT

If there are still any issues pending or problems arising after your purchase, we will support you by e-mail, telephone and with our ticket support system.

E-Mail: service@joy-it.net

Ticket system: <http://support.joy-it.net>

Telephone: +49 (0)2845 98469-66 (10-17 o'clock)

For further information please visit our website:

www.joy-it.net