

Joker XL

(Alle Versionen / All Versions)

R/C Elektromodell /
Electric Powered Model

Vorbereitet für den Einbau eines Elektroantriebs
und einer Schleppkupplung für den Seglerschlepp.
*Factory-prepared for use of electric motor
and convenient glider towing system.*



Vorbereitet für Landeklappen.
Factory-prepared for Flaps.

95% vormontiert
ARF
ALMOST READY TO FLY

Technische Daten *

Spannweite	2120mm
Länge	1600mm
Flächeninhalt	75dm ²
Flächenbelastung	50g/dm ²
Fluggewicht	3800g
R/C	4 -6 Kanal
Servos	4 -7
Motor	BOOST 80 Brushless
Regler	Combo
Akku	4300-6500mAh / 22,2V

Specifications *

Wingspan	2120mm
Length	1600mm
Wing Area	75dm ²
Wing loading	50g/dm ²
Flying Weight	3800g
R/C	4 -6 channels
Servos	4 -7
Motor	BOOST 80 Brushless
ESC	Combo
Akku	4300-6500mAh / 22,2V

Dieses ferngesteuerte R/C Flugmodell ist für Anfänger nicht geeignet sondern richtet sich an fortgeschrittene Modellbauer. Trotz sehr hoher Vorfertigung erfordern die Endmontage und der Betrieb des Modells etwas Übung sowie grundlegende Erfahrungen. Wenn Sie unerfahren sind, bitten Sie einen Modellbaukollegen um Hilfe oder fragen Ihren Modellbau-Fachhändler vor Ort. Bevor Sie mit dem Zusammenbau beginnen, prüfen Sie den Inhalt auf Vollständigkeit, Passgenauigkeit bzw. eventuelle Mängel. Für den Zusammenbau benötigen Sie das übliche Werkzeug sowie Klebstoffe wie Sekundenkleber und 5-Minuten Epoxy. Der Lieferumfang kann ggf. abweichen. Das Modell wurde von erfahrenen Mitarbeitern weitgehendst in Handarbeit gefertigt und selbstverständlich vor dem Versand im Werk sorgfältig geprüft. Trotzdem bitten wir Sie zu beachten:
Wir entwickeln und fertigen unsere Modelle zum Fliegen, und nicht um damit einen Scale-Wettbewerb zu gewinnen.
 Deshalb gilt: Kleine Unregelmäßigkeiten am Modell sind normal und berechtigen nicht zur Reklamation. Ein gewisses Maß an Nacharbeit kann erforderlich sein und ist dem Kunden (= fortgeschrittener Modellbauer) zuzumuten.
 Das Modell wurde werksseitig mit hochwertiger, bedruckter, selbstklebender PVC-Folie falten- und blasenfrei bespannt. Aufgrund von Temperaturschwankungen während Transport und Lagerung sowie auch an warmen und heißen Plätzen kann es zu mehr oder weniger starker Falten- und Blasenbildung kommen. Dies ist normal und kein Reklamationsgrund. Mit einem Heißluftgebläse (Fön) kann die Folie unter vorsichtiger Wärmeeinwirkung wieder gespannt werden. Verwenden Sie unter keinen Umständen ein Bügeleisen da sonst die Druckfarbe auf der Folie verschmiert. Vielen Dank für Ihr Verständnis.

WARNING.

Please be aware that this aeroplane is not a toy and if assembled or used incorrectly it is capable of causing injury to people or property. WHEN YOU FLY THIS AEROPLANE YOU ASSUME ALL RISK & RESPONSIBILITY.

If you are inexperienced with basic R/C flight we strongly recommend you contact your R/C supplier and join your local R/C Model Flying Club. R/C Model Flying Clubs offer a variety of training procedures designed to help the new pilot on his way to successful R/C flight. They will also be able to advise on any insurance and safety regulations that may apply.

TOOLS & SUPPLIES NEEDED.

- Thick cyanoacrylate glue.
- 30 minute epoxy.
- 5 minute epoxy.
- Hand or electric drill.
- Assorted drill bits.
- Modelling knife.
- Straight edge ruler.
- 2mm ball driver.
- Phillips head screwdriver.
- 220 grit sandpaper.
- 90° square or builder's triangle.
- Wire cutters.
- Masking tape & T-pins.
- Thread-lock.
- Paper towels.

SUGGESTION.

To avoid scratching your new airplane, do not unwrap the pieces until they are needed for assembly. Cover your workbench with an old towel or brown paper, both to protect the aircraft and to protect the table. Keep a couple of jars or bowls handy to hold the small parts after you open the bag.

NOTE.

Please trial fit all the parts. Make sure you have the correct parts and that they fit and are aligned properly before gluing! This will assure proper assembly **JOCKER-ARF** is hand made from natural materials, every plane is unique and minor adjustments may have to be made. However, you should find the fit superior and assembly simple.

The painted and plastic parts used in this kit are fuel proof. However, they are not tolerant of many harsh chemicals including the following: paint thinner, C/A glue accelerator, C/A glue debonder and acetone. Do not let these chemicals come in contact with the colors on the covering and the plastic parts.

Sonderzubehör für Joker XL / Accessories for Joker XL

Nachstehendes Zubehör wurde von uns ausgiebig erprobt und wird für beste Flugeigenschaften empfohlen. Weitere Informationen und Bestellmöglichkeit unter www.pichler-modellbau.de
These accessories have been extensively tested and are recommended for best flying performance.
 For more information please visit www.pichler-modellbau.de



C4504
 Brushless Combo BOOST 80 inklusive Motor, Regler und Programmierkarte



C9491
 Akku LEMONRC 6300-6S
 Battery LEMONRC 6300-6S



C5758
 PI-CON Propeller 17 x 8



C4740
 Akku Klettband
 Battery Straps



4 -7 x # C1689 Servo DS6020
 oder / or
 4 -7 x # C4994 Servo DS4020



C5906 Contest Spinner 70mm schwarz/black
 # C5905 Contest Spinner 70mm rot/red
 # C5904 Contest Spinner 70mm weiß/white



5-Min. Epoxy
 X3598-200



Geheimtipp! Must Have !

C8188 Schutztaschenset für Tragflächen (1 Paar)

SAFETY PRECAUTION.

- + This is not a toy
- + Be sure that no other flyers are using your radio frequency.
- + Wear safety glasses.
- + Keep loose clothing and wires away from the propeller.

- + Do not start the motor if people are near. Do not stand in line with the side of the propeller.
- + Make motor adjustments from behind the propeller only. Do not reach around the spinning propeller.

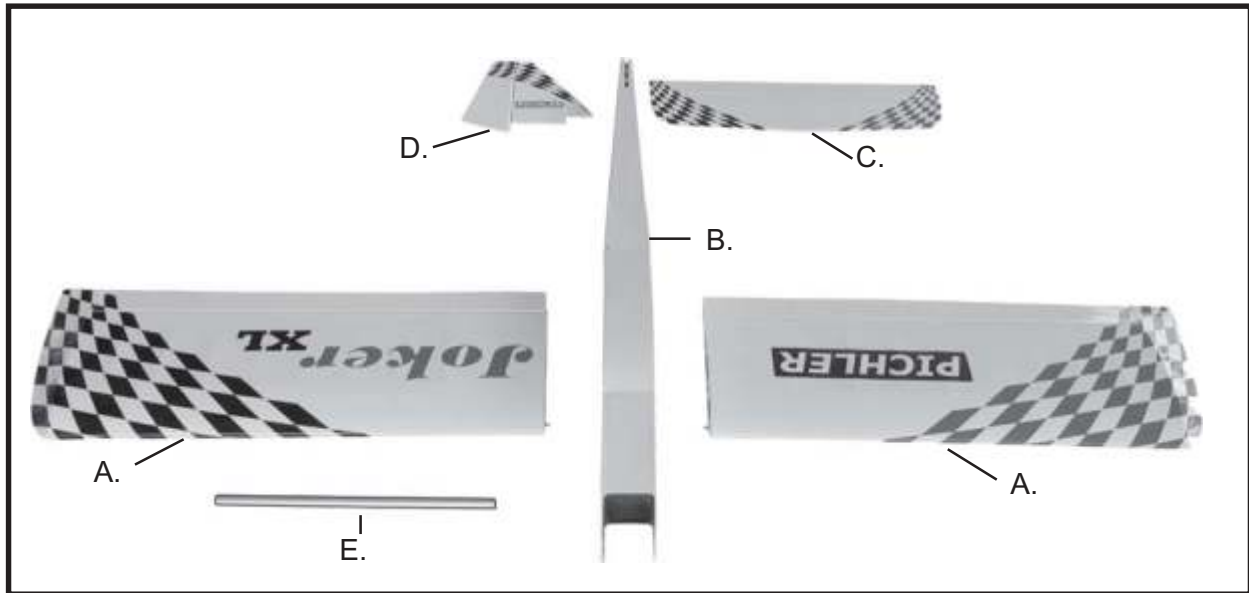

A. Wing panel.

B. Fuselage.

C. Horizontal stabilizer

E. Vertical stabilizer

E. Aluminium wing dihedral brace.

G. Decal sheet.

SMALL PARTS / Kleinteile

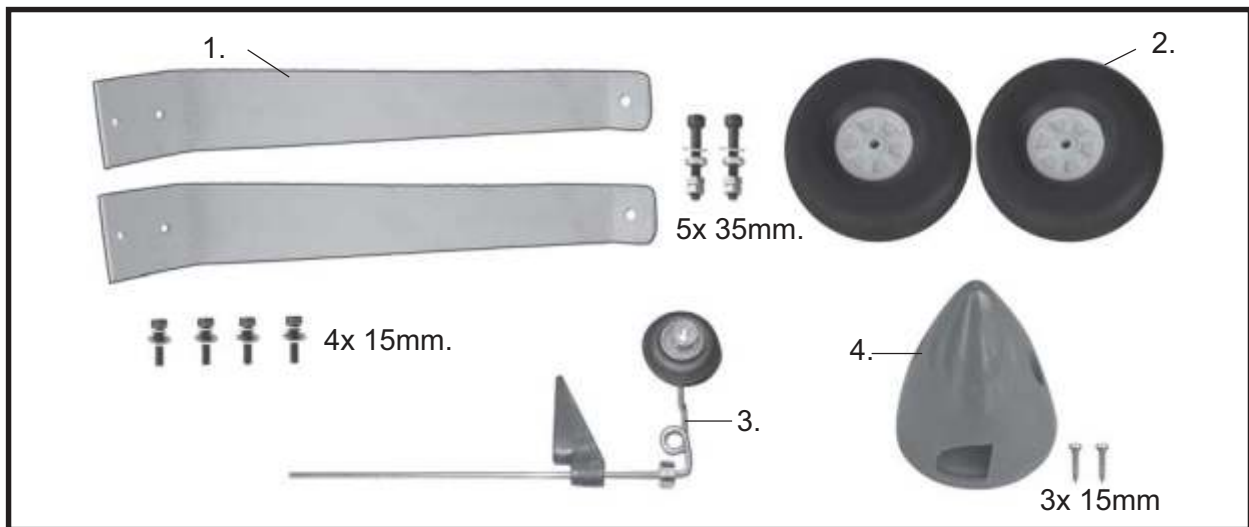

1. Aluminium landing gear.

2. Wheels.

3. Tail gear set.

4. Spinner

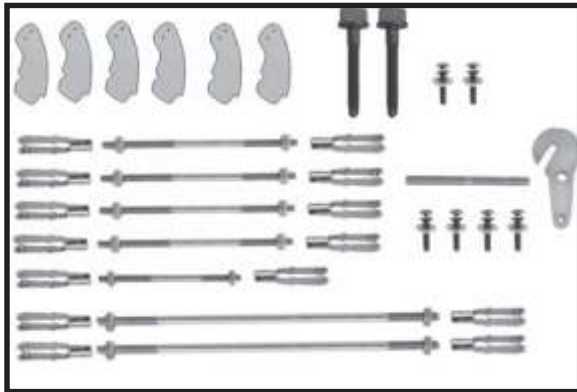

AILERON SERVOS.

1.INSTALLING THE AILERON SERVOS

1) Install the rubber grommets and brass eyelets onto the aileron servos.



Attention: You can use either 1 or 2 aileron servos per wing panel.

Achtung: Sie können entweder 1 oder 2 Querruderservos pro Tragflächenhälfte verwenden.

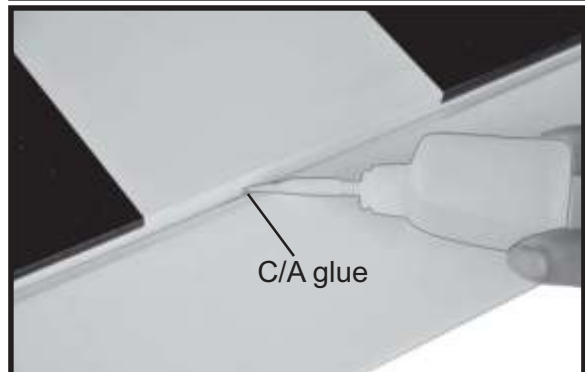
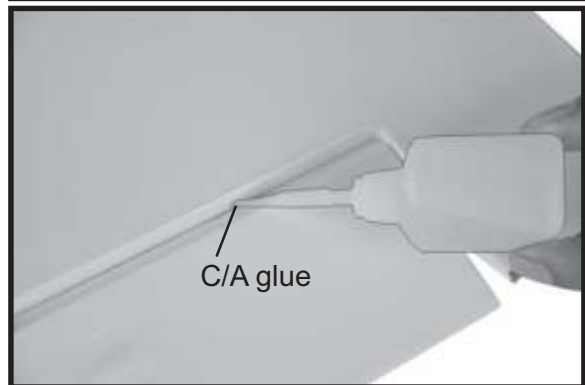
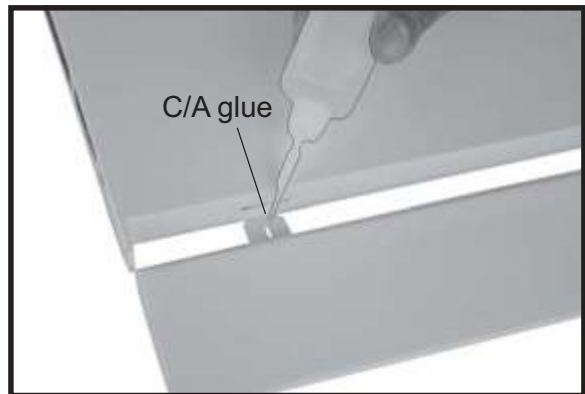
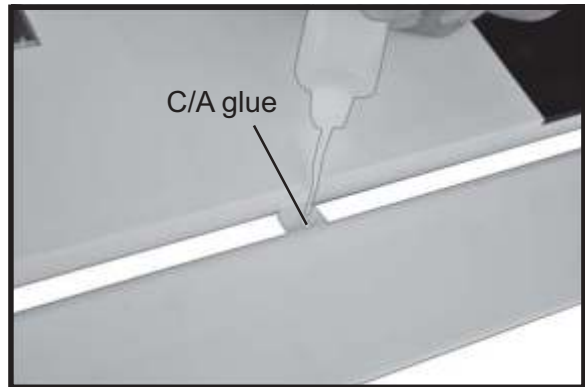
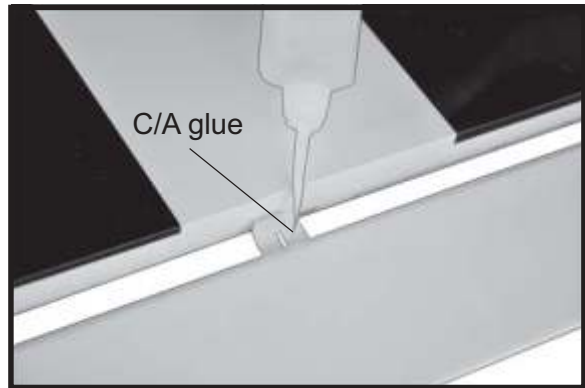
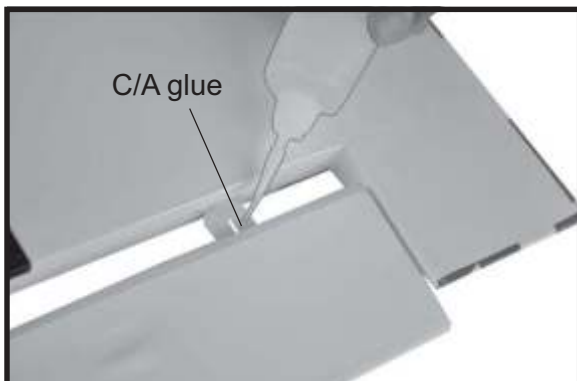
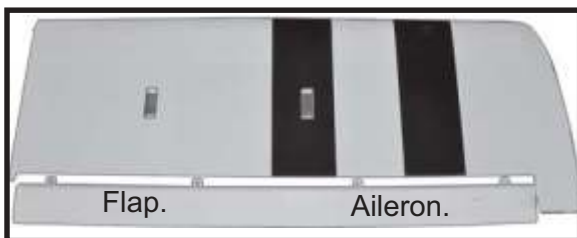

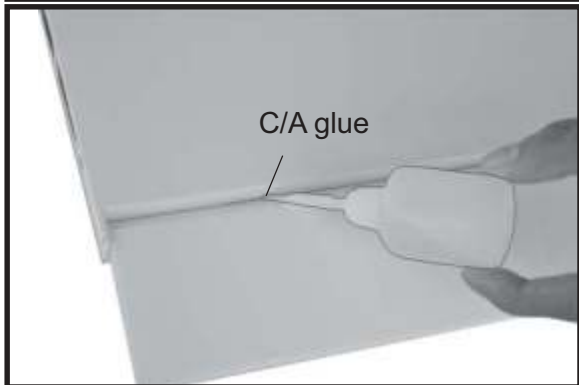
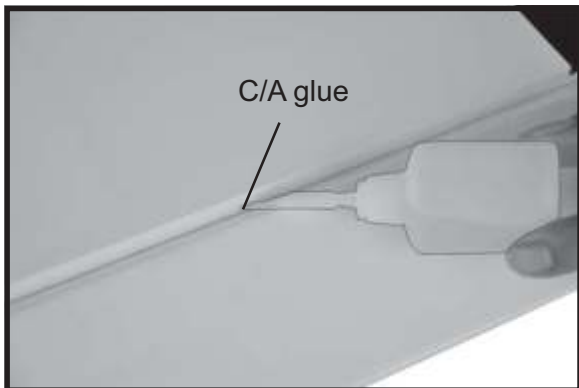

□ 2) Using a modeling knife, remove the covering at position show below.



□ 3) Using the thread as a guide and using masking tape, tape the servo lead to the end of the thread: carefully pull the thread out. When you have pulled the servo lead out, remove the masking tape and the servo lead from the thread.

□ 4) Drill 1,6mm pilot holes through the block of wood for each of the four mounting screws provided with the servo.

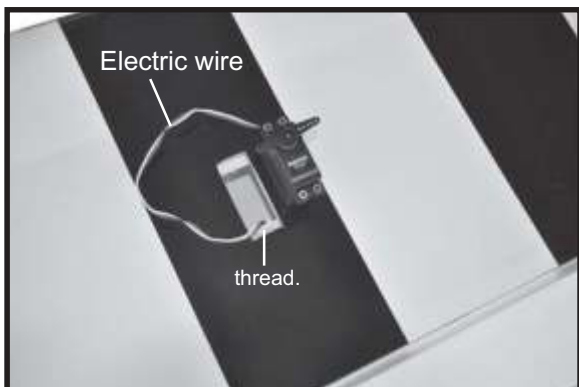

□ 5. Instal servo tray with aileron servo into the wing as same as picture below.

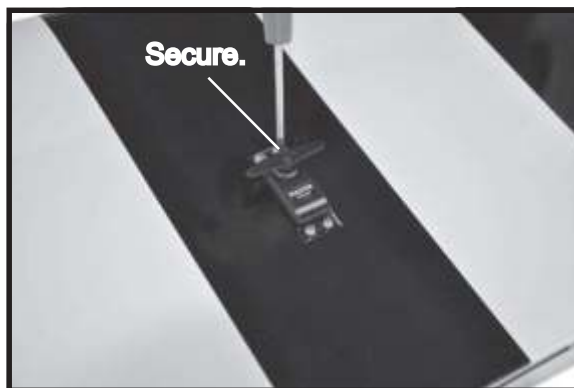

2.INSTALLING THE AILERON CONTROL HORN.

Aileron control horn



A+B Epoxy PLUS glue

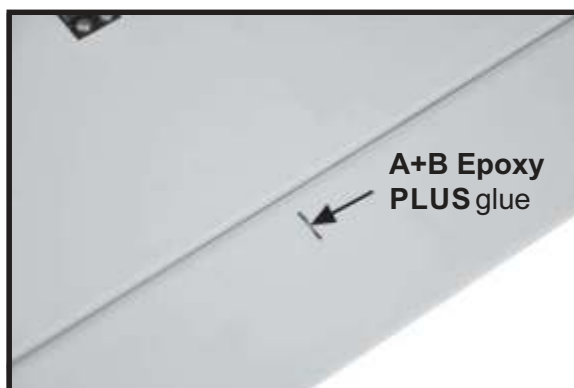

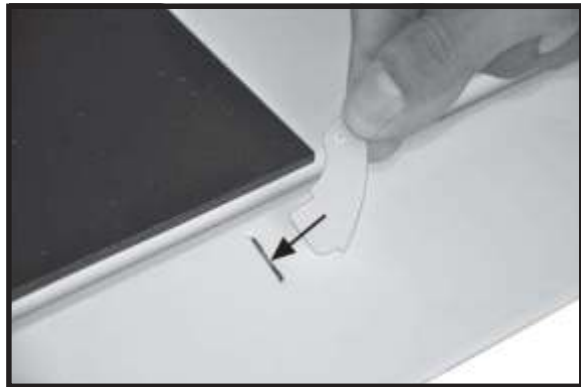

3.INSTALLING THE AILERON LINKAGES.

Installing the air brake linkages as pictures below.

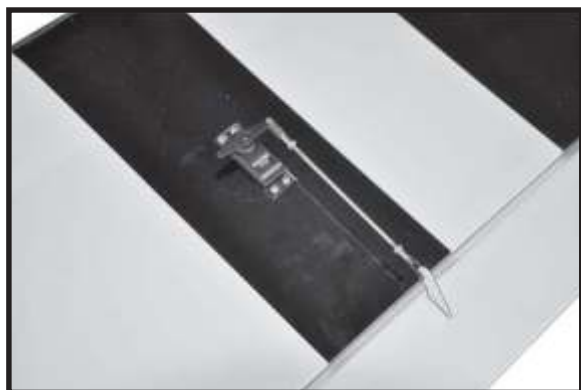
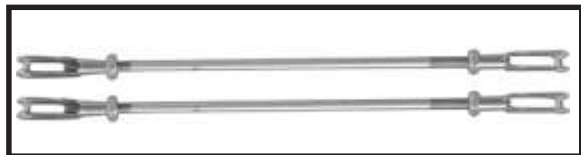
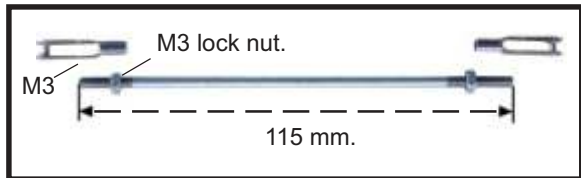

Repeat the procedure for the other wing half.

FLAP SERVOS.

1.INSTALLING THE FLAP SERVOS.

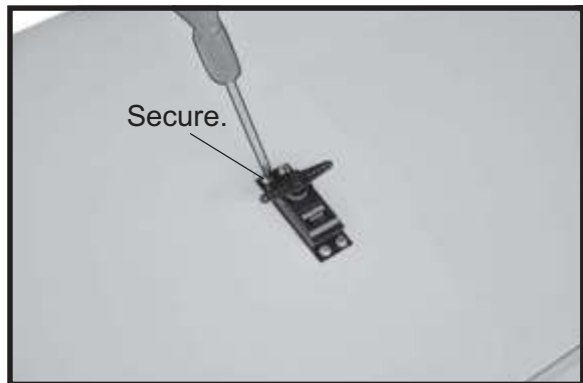
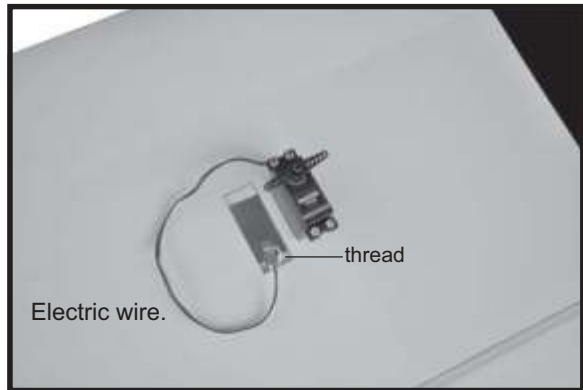

Repeat the procedure for the other wing half.

2.INSTALLING THE FLAP CONTROL HORN.

Flap control horn.



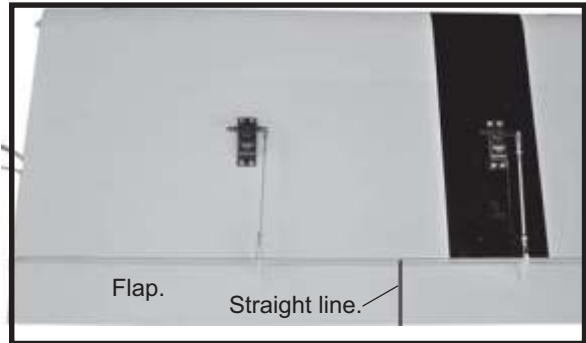
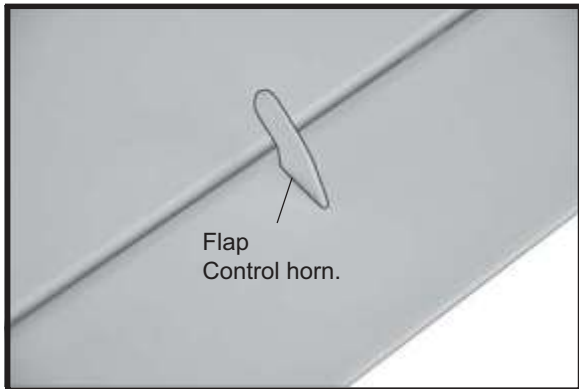
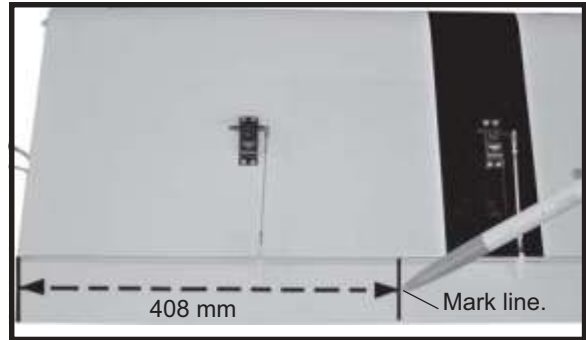
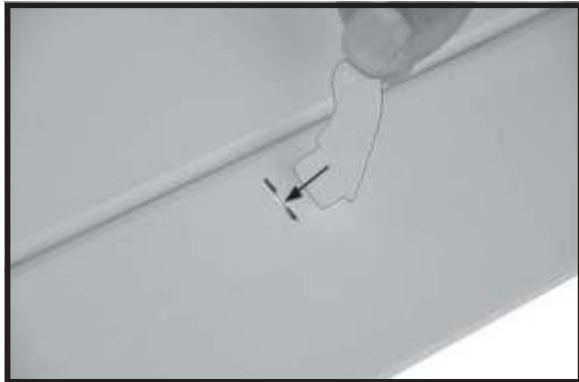
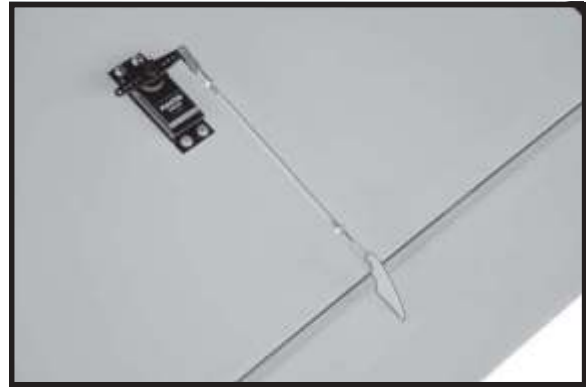
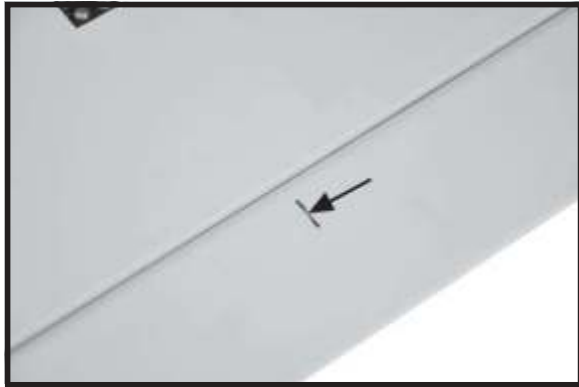

3. INSTALLING THE FLAP LINKAGES.

Installing the air brake linkages as pictures below.

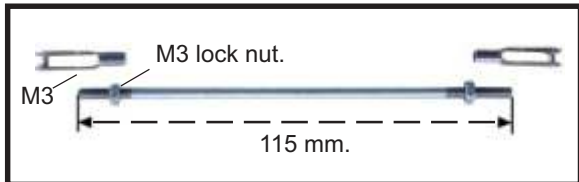
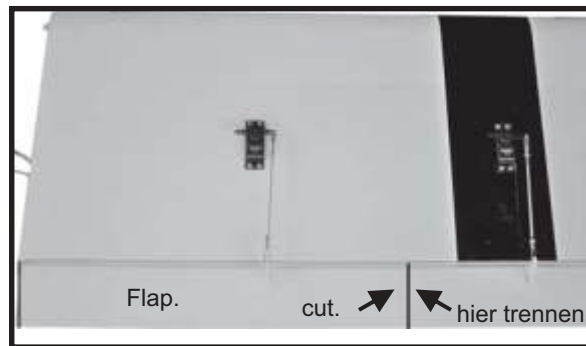

Wenn Sie Landeklappen nutzen möchten trennen Sie bitte hier das Querruder mit einer feinen Säge.
If you want to use flaps, cut the aileron as shown above.

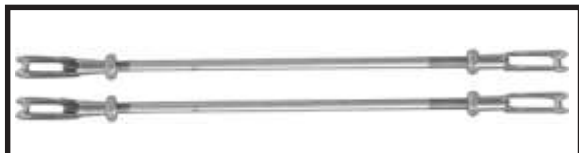

INSTALLING ELECTRIC MOTOR.

See picture below:

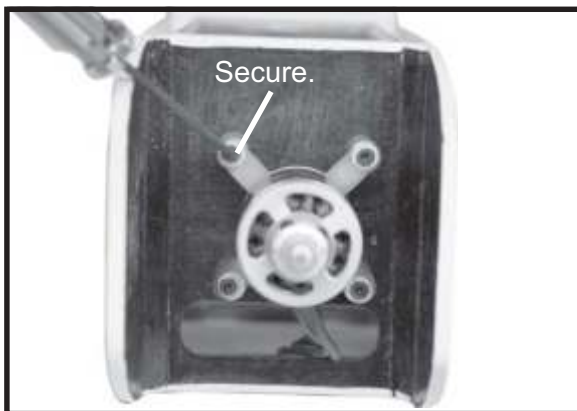
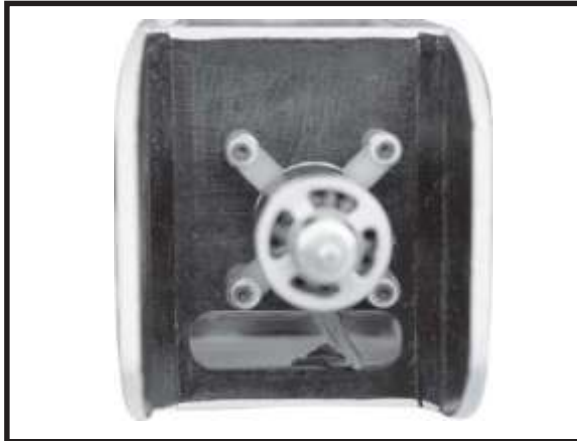

INSTALLING THE SPINNER.

□ Install the spinner backplate, propeller and spinner cone. The spinner cone is held in place using two 3mm x 15mm wood screws.

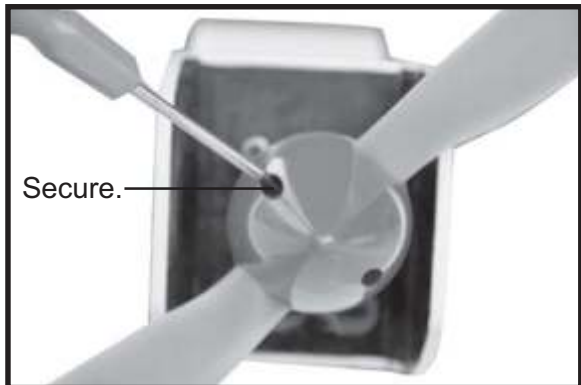
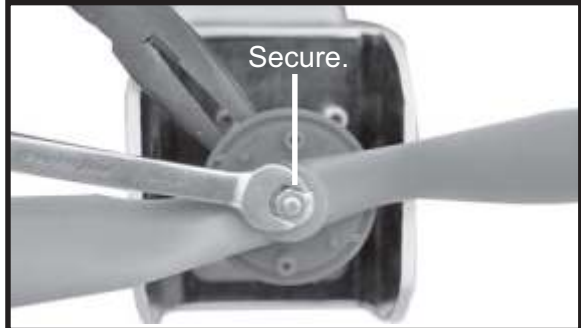



INSTALLING THE BATTERY.

See picture below:



SERVO INSTALLATION.

See picture below:

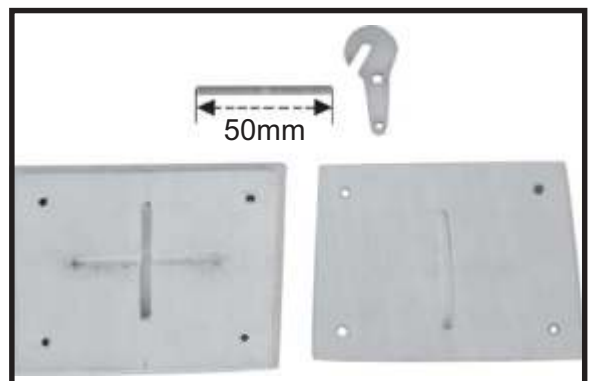
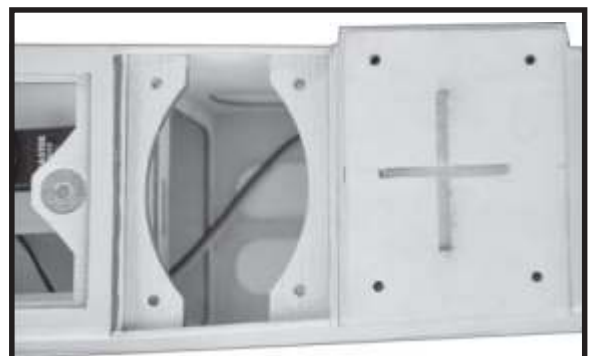
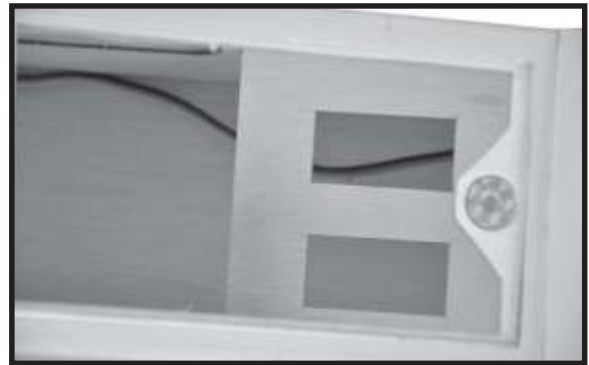

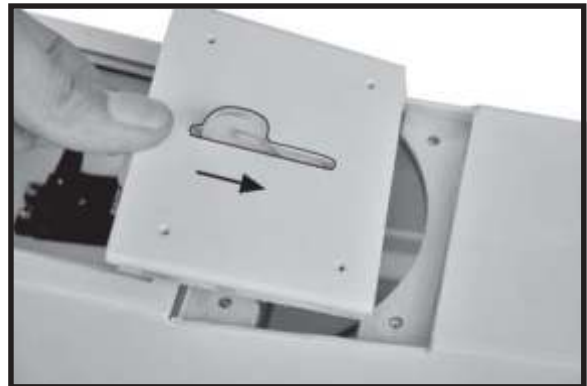
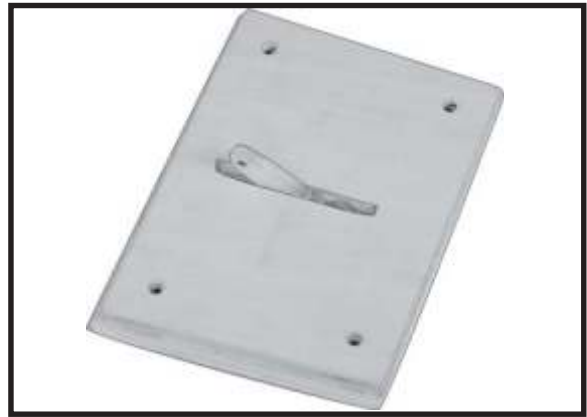
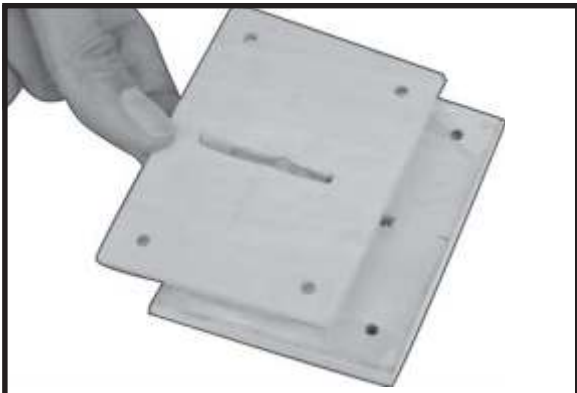
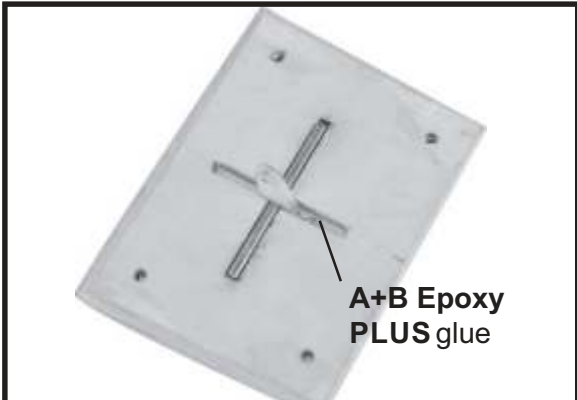
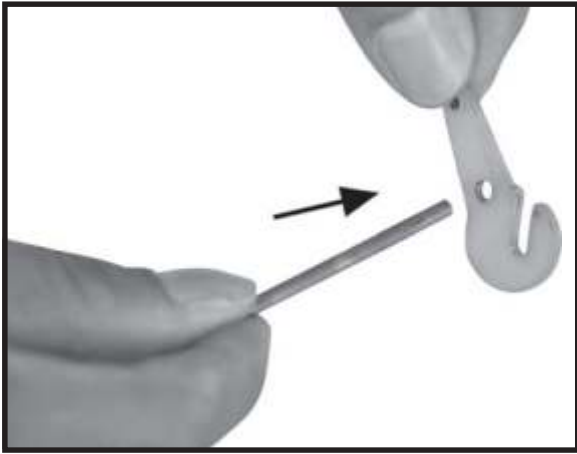

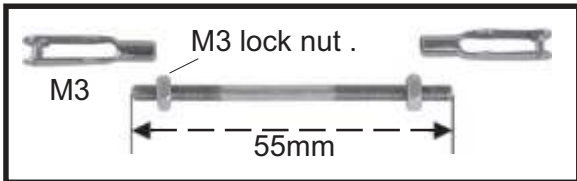
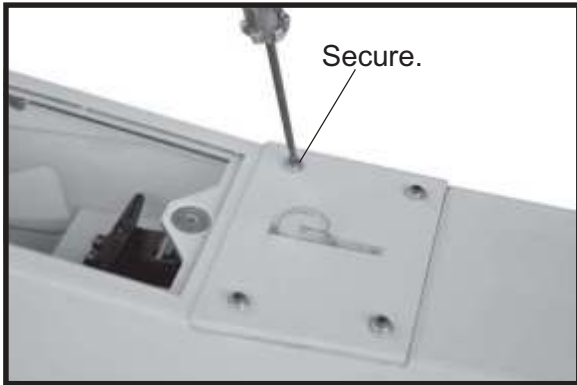

INSTALLING THE MAIN LANDING GEAR
PARTS REQUIRED



□ 1. The blind nuts are already mounted inside the fuselage.

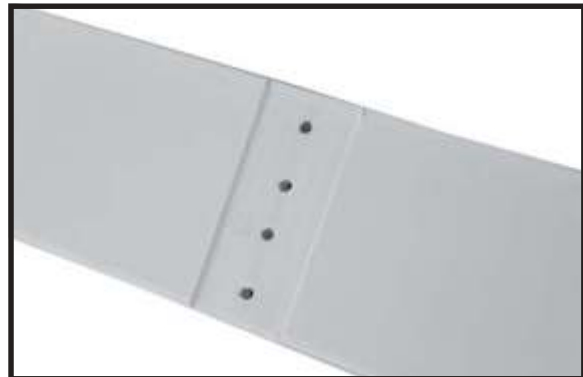

□ 2. The holes in the landing gear should be to accept the mounting bolts.

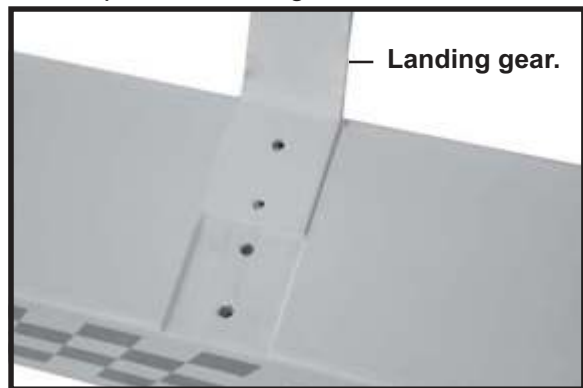

□ 3. Using the hardware provided, mount the main landing gear to the fuselage.

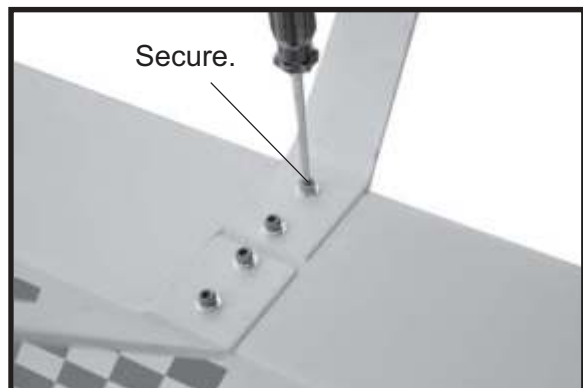



4. Assemble and mounting the wheel pants as shown in the following pictures.



5. A drop of C/A glue on the wheel collar screws will help keep them from coming loose during operation.

Repeat the process for the other wheel.

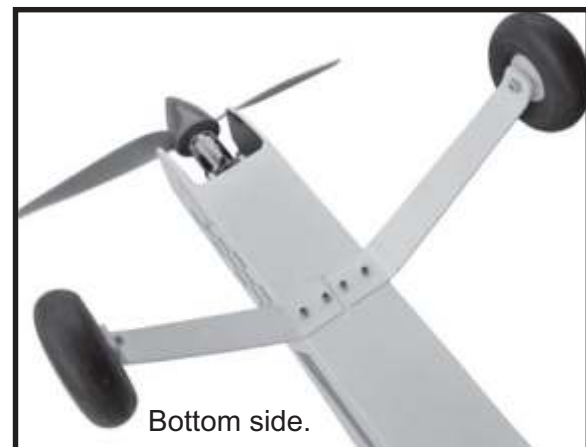
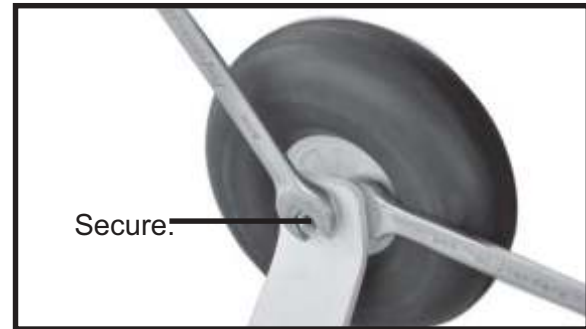

ELEVATOR INSTALLATION.

SERVO INSTALLATION.

- 1. Install the rubber grommets and brass collets into the elevator servo. Test fit the servo into the servo tray.
- 2. Mount the servo to the tray using the mounting screws provided with your radio system.





HORIZONTAL STABILIZER INSTALLATION

Horizontal stabilize installation .
See picture below.

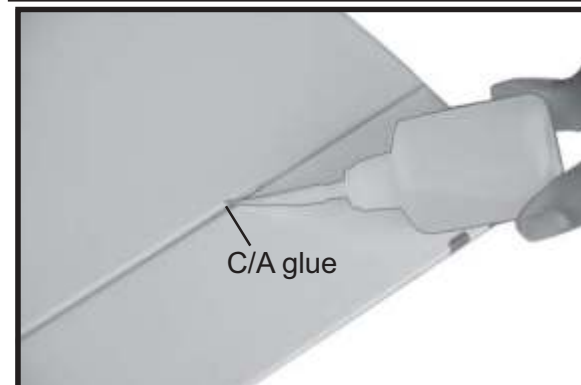
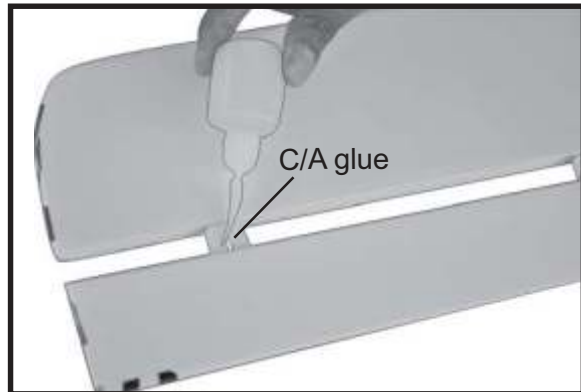
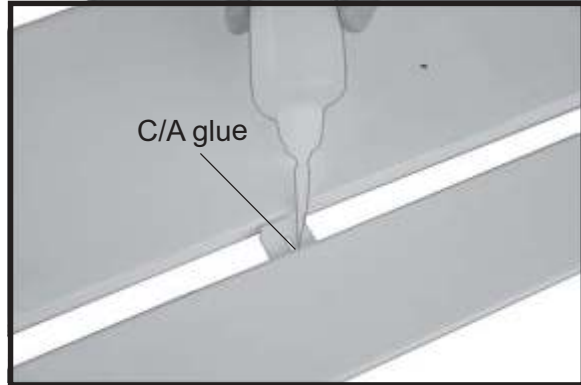
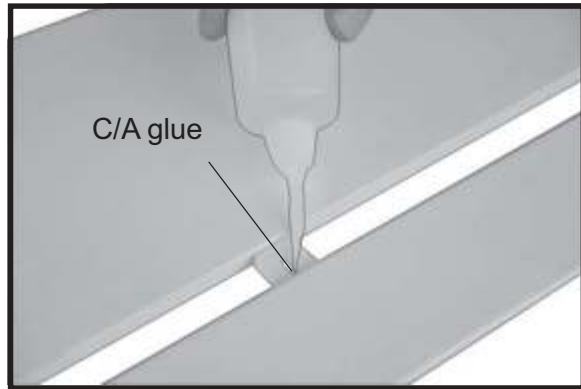
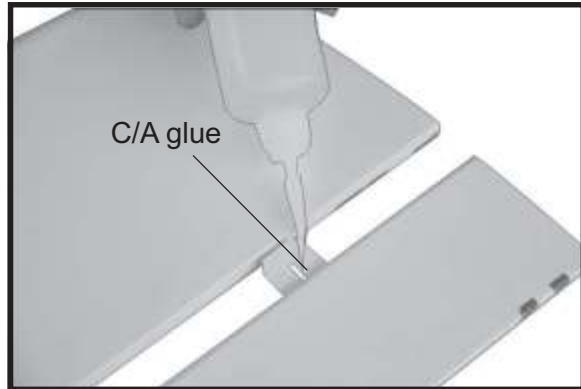

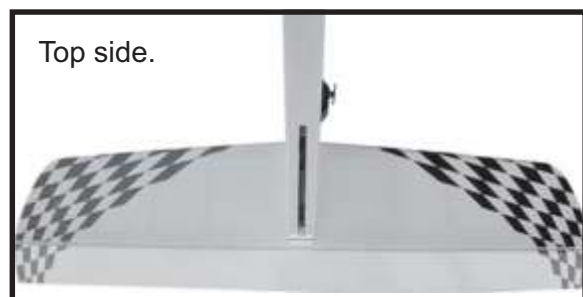
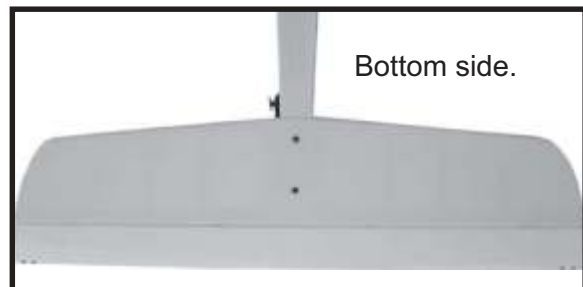
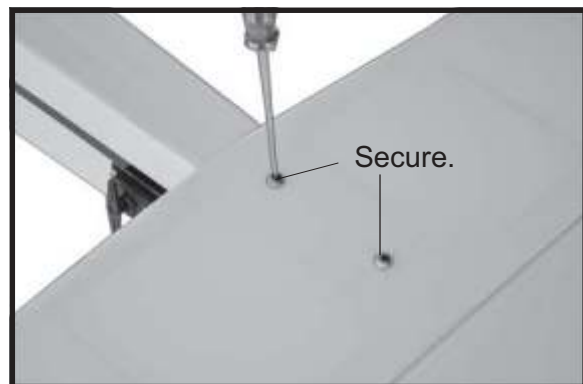
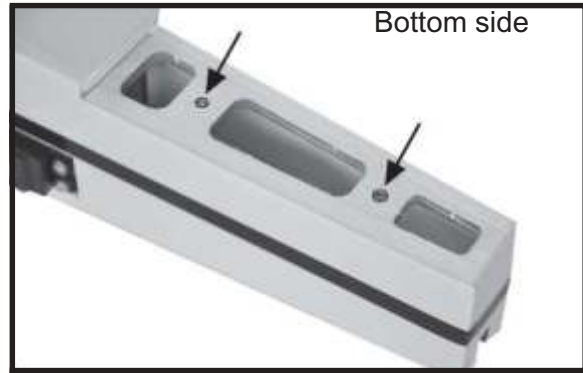
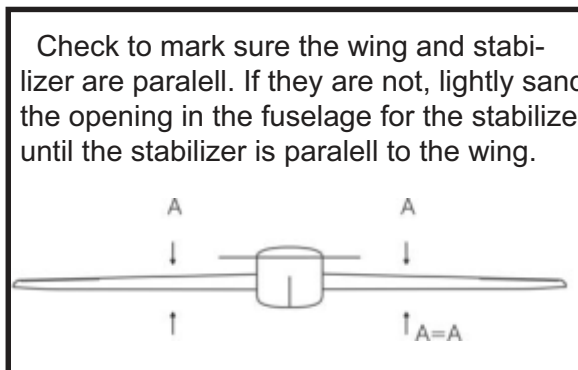
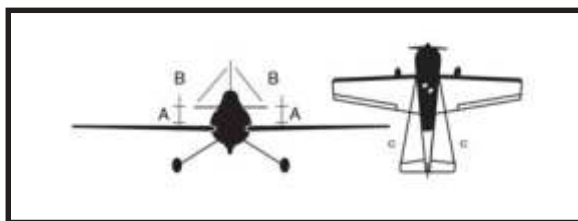
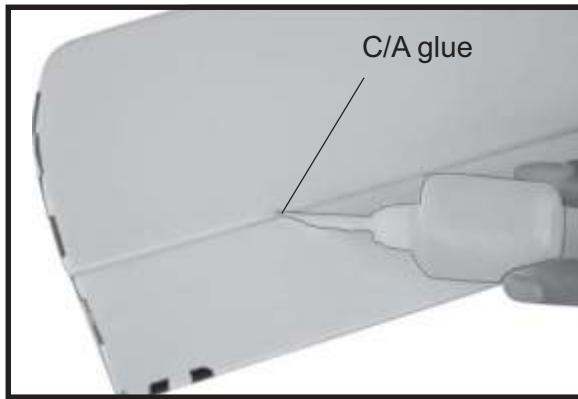
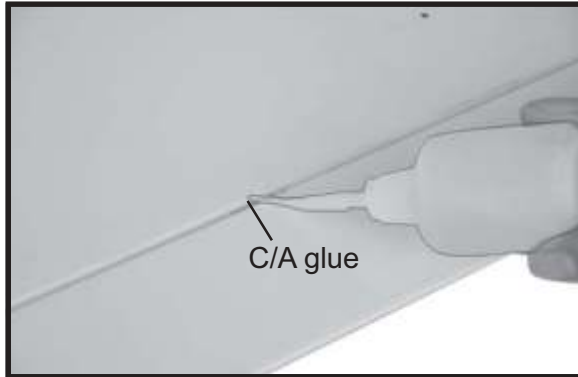

ELEVATOR CONTROL HORN INSTALLATION.

Elevator control horn install as same as the way of aileron control horn. Please see pictures below.

Elevator control horn.

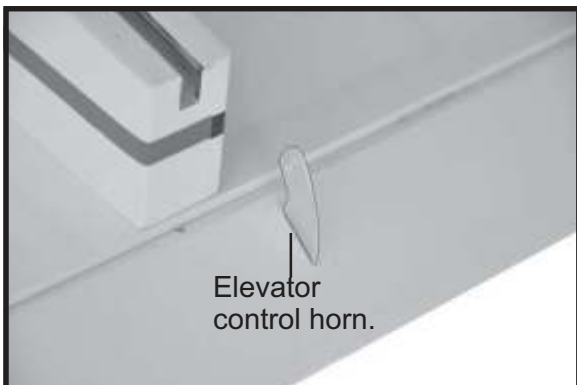
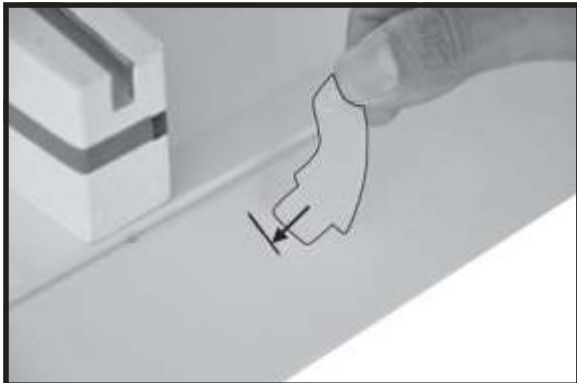
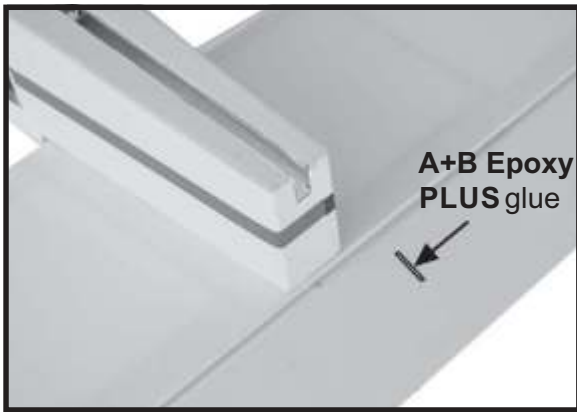

ELEVATOR PUSHROD INSTALLATION.

Elevator pushrod install as same as the way of aileron pushrod.

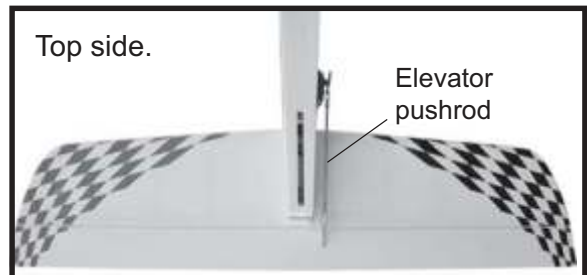
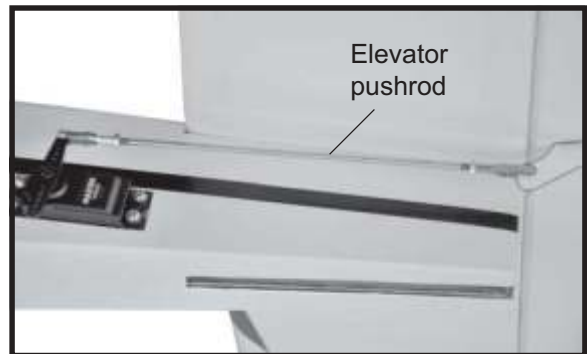
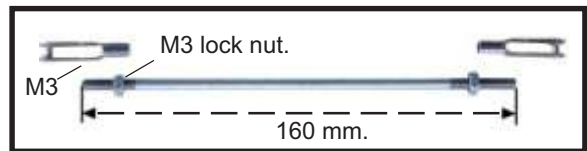

MOUNTING THE TAIL WHEEL BRACKET.

1) Set the tail wheel assembly in place on the plywood plate. The pivot point of the tail wheel wire should be even with the rudder hinge line and the tail wheel bracket should be centered on the plywood plate.

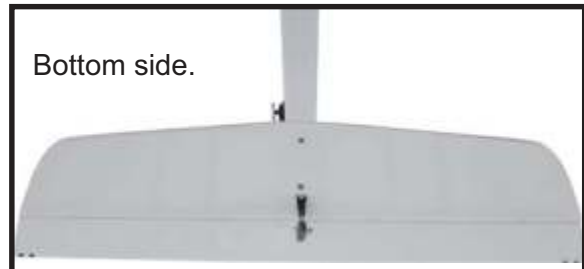
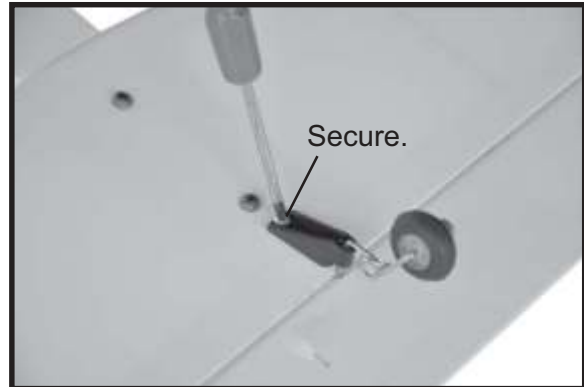
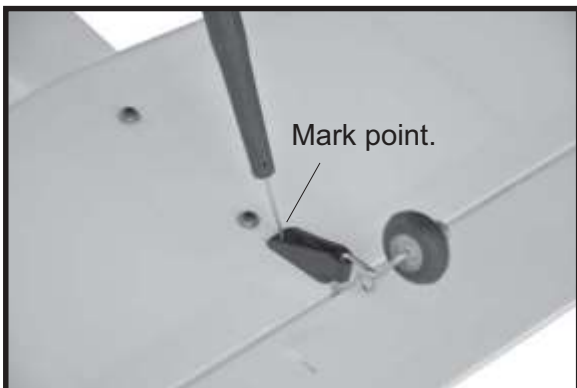
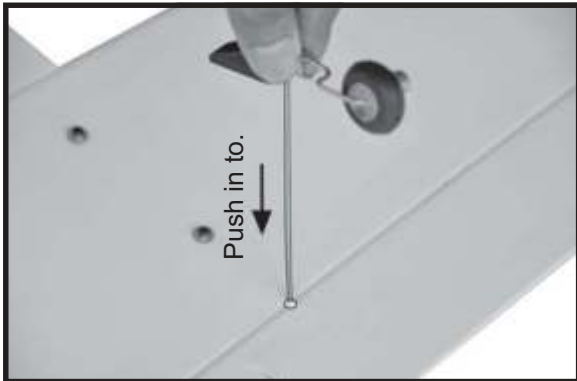

RUDDER SERVO INSTALLATION.

Rudder servo install as same as method of elevator servo. See picture below:

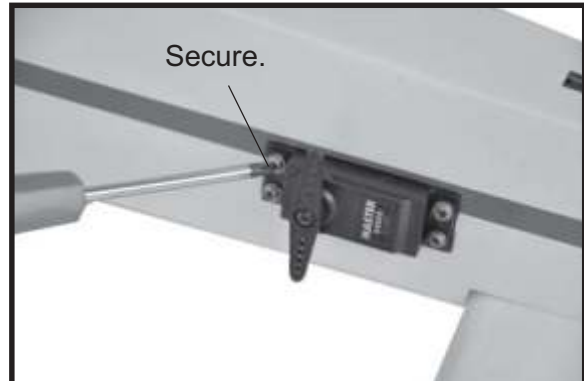
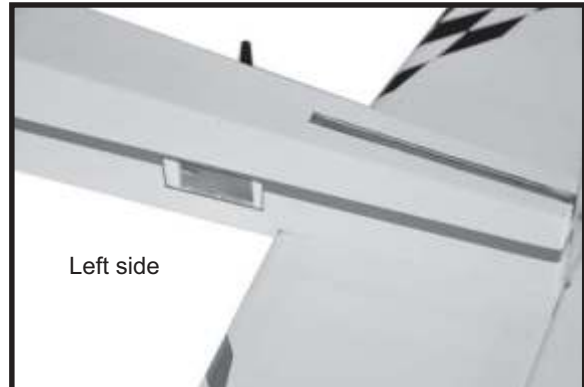

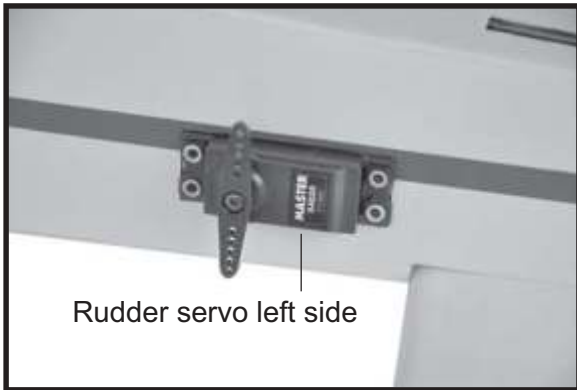

VERTICAL INSTALLATION.

- Vertical stabilizer installation
See picture below.



1. Slide the rudder into the fuselage as same as picture below.

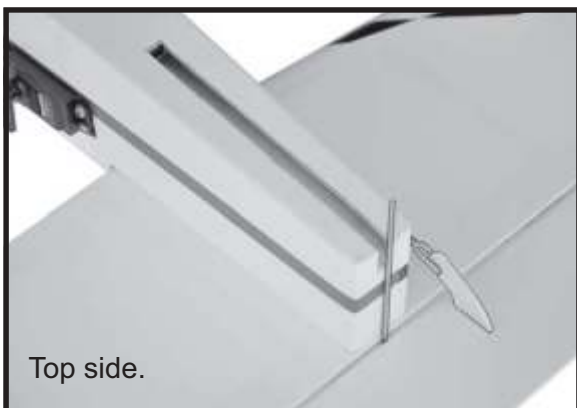

- 2. Mark the shape of the vertical on the left and right side on the rudder using a felt-tip pen.

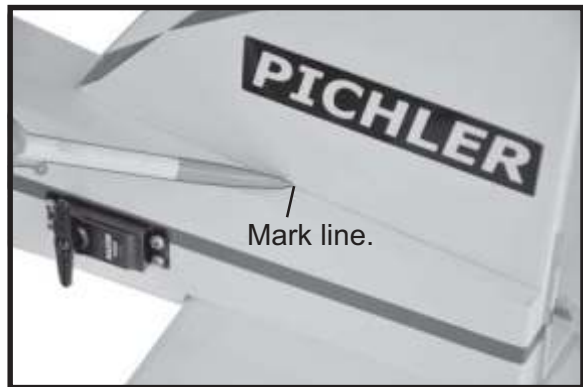

- 3. Now, remove the rudder and using a modeling knife, carefully cut just inside the marked lines and remove the film of the rudder. Just as you did with the horizontal stabilizer, make sure you only press hard enough to cut the film, not the balsa rudder.



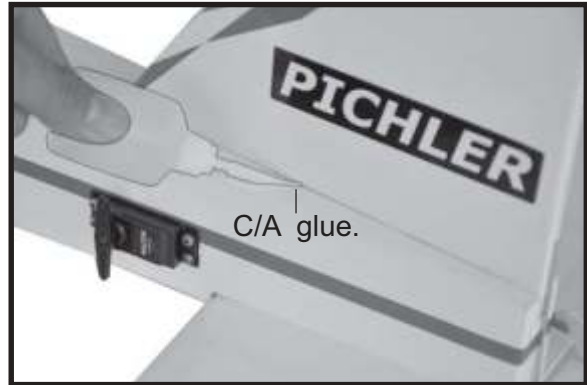
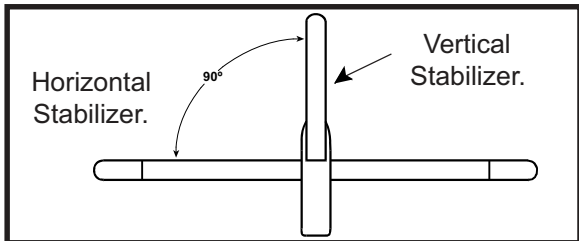
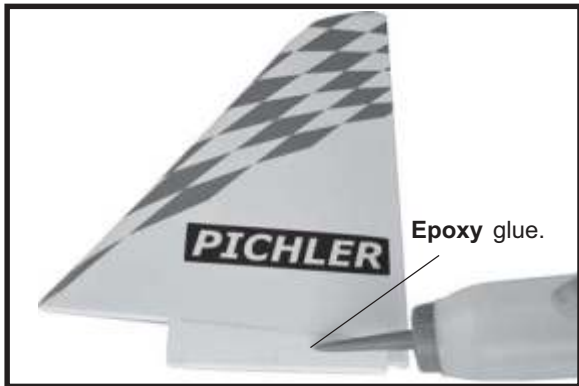
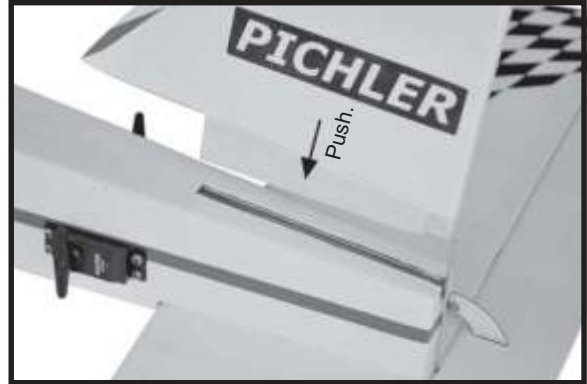

4. Put the vertical stabilizer back in place. Using a triangle, check to ensure that the vertical stabilizer is aligned 90 degree to the horizontal stabilizer.

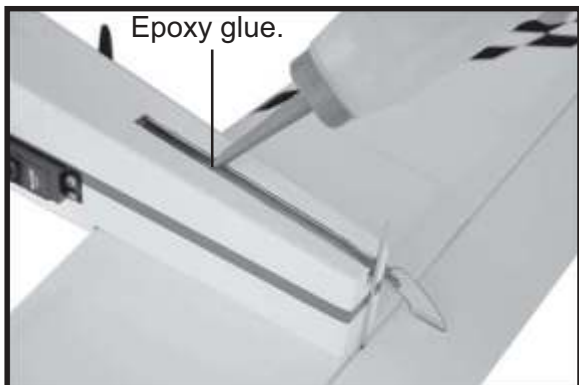

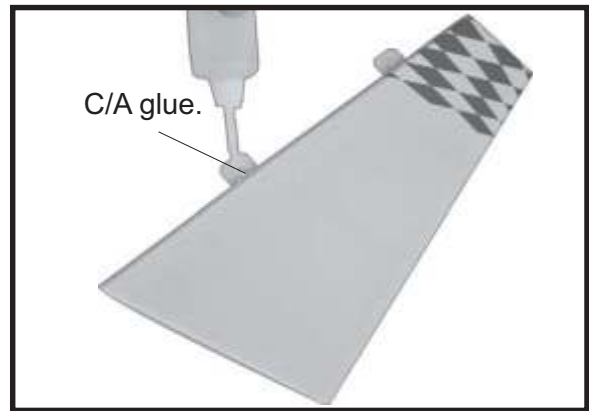
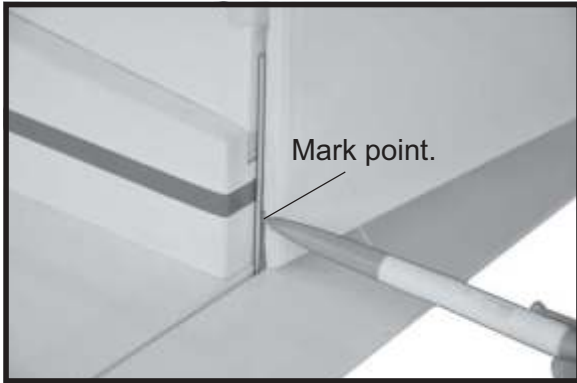
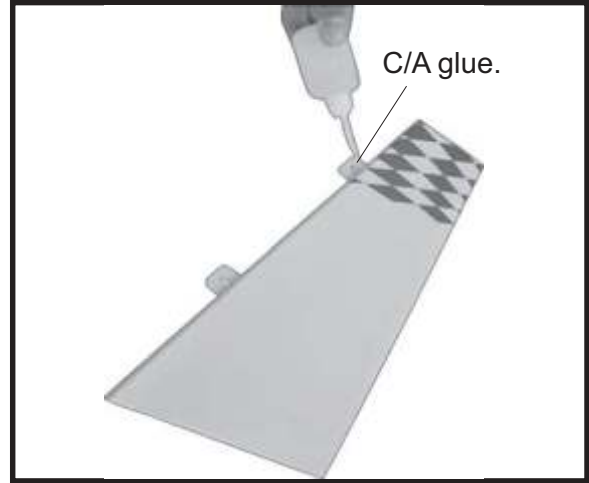
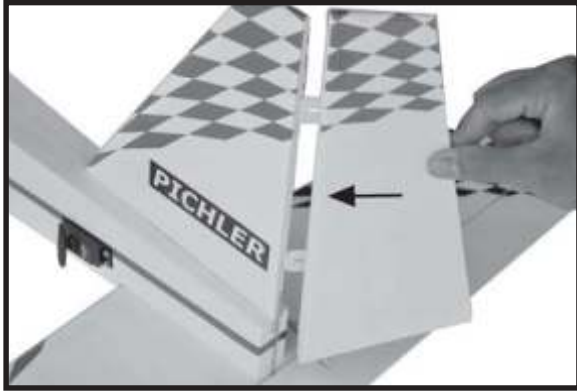

Carefully make a 90 degree bend down at the mark made. Cut off the excess wire, leaving about 20mm beyond the bend.

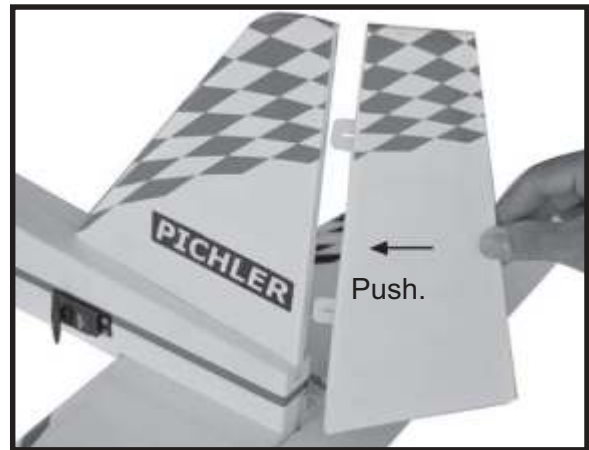
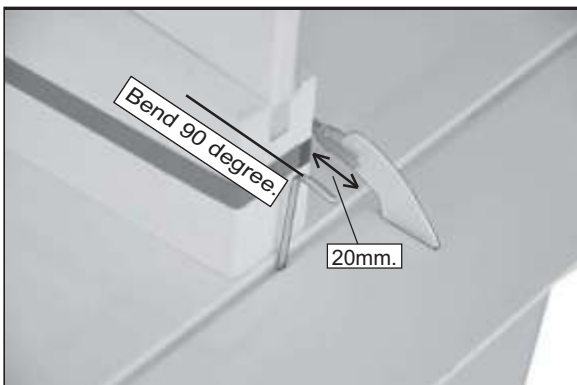
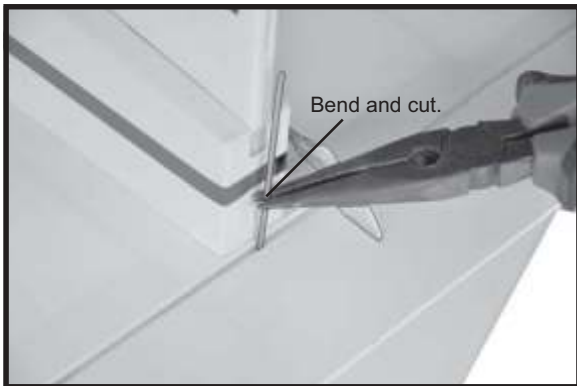

5) When you are sure that everything is aligned correctly, mix up a generous amount of 30 minute epoxy. Apply a thin layer to the slot in the mounting platform and to the vertical stabilizer mounting area. Apply epoxy to the lower rudder mounting hinge. Set the stabilizer in place and re-align. Double check all of your measurements once more before the epoxy cures. Remove any excess epoxy using a paper towel and rubbing alcohol and hold the stabilizer in place with T-pins or masking tape. Allow the epoxy to fully cure before proceeding.

RUDDER CONTROL HORN INSTALLATION.

Rudder control horn install as same as the way of aileron control horn. Please see pictures below.

Rudder control horn.

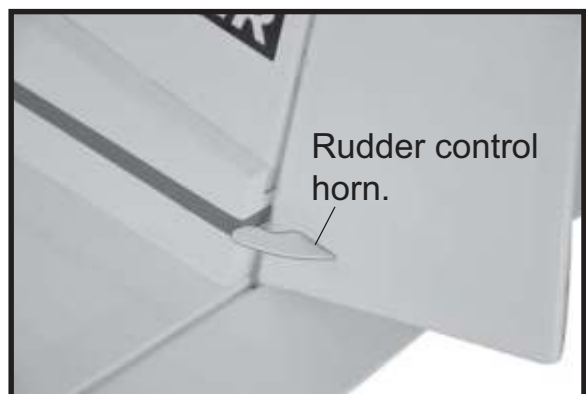
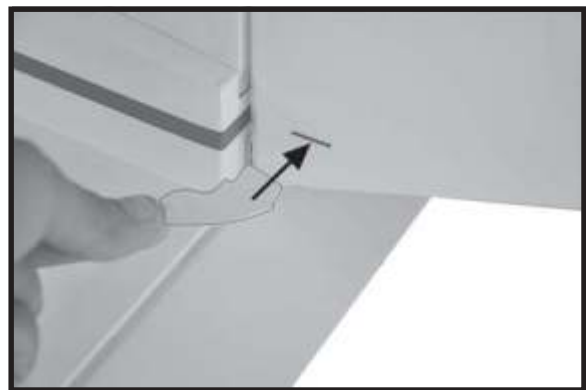
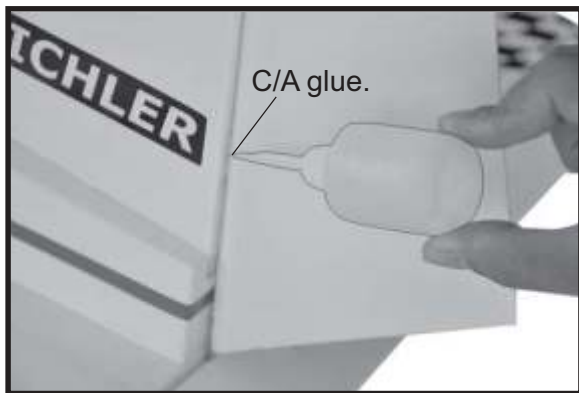
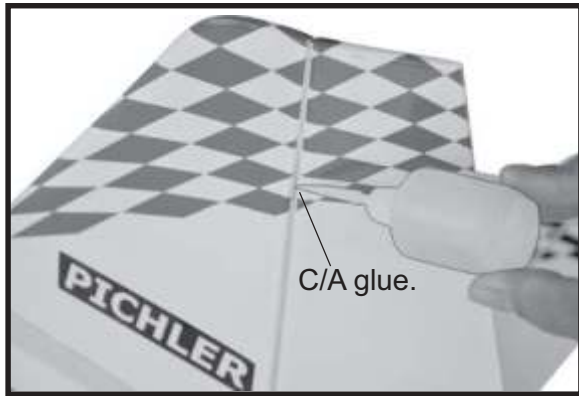

RUDDER PUSHROD INSTALLATION.

Rudder pushrod install as same as the way of aileron pushrod.

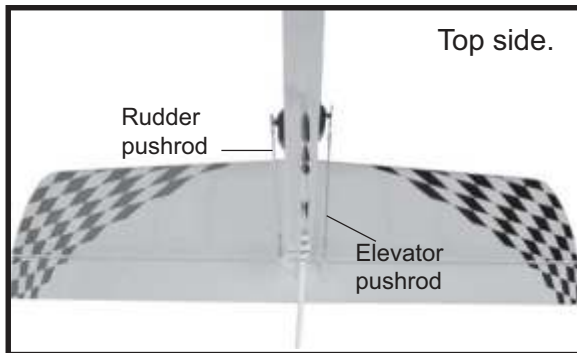
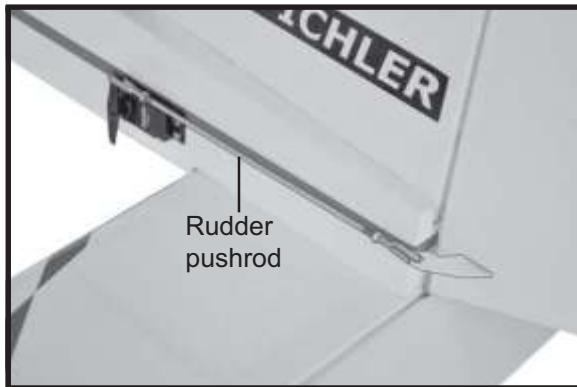
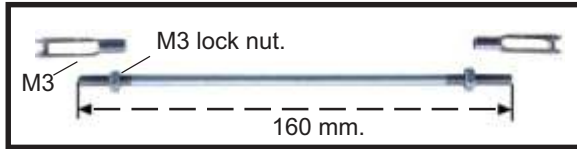

INSTALLING THE RECEIVER AND BATTERY

1. Plug the servo leads and the switch lead into the receiver. You may want to plug an aileron extension into the receiver to make plugging in the aileron servo lead easier when you are installing the wing. Plug the battery pack lead into the switch.

2. Wrap the receiver and battery pack in the protective foam to protect them from vibration. Use a rubber band or masking tape to hold the foam in place.

3. Position the battery pack and receiver behind the fuel tank. Use two tie wraps to hold the battery and receiver securely in place as pictures below

Do not permanently secure the receiver and battery until after balancing the model.

4. Using a 2mm drill bit, drill a hole through the side of the fuselage, near the receiver, for the antenna to exit.

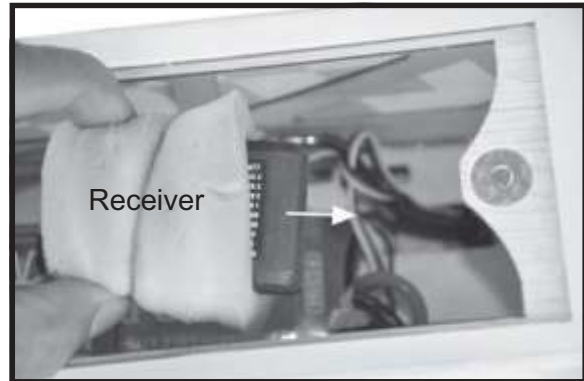

WING ATTACHMENT.

Locate the aluminium wing dihedral brace.

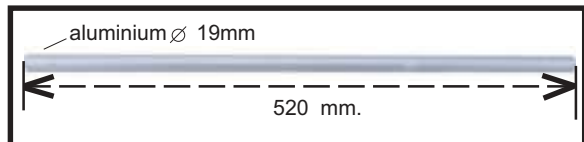

*** Test fit the aluminium tube dihedral brace into each wing haft. The brace should slide in easily. If not, use 220 grit sand around the edges and ends of the brace until it fits properly.

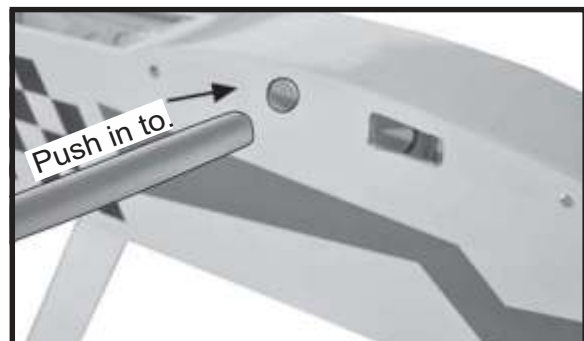

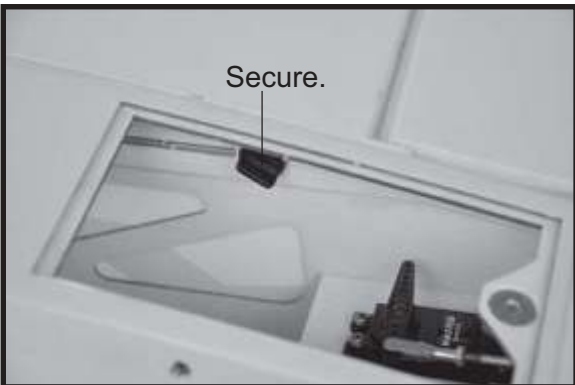
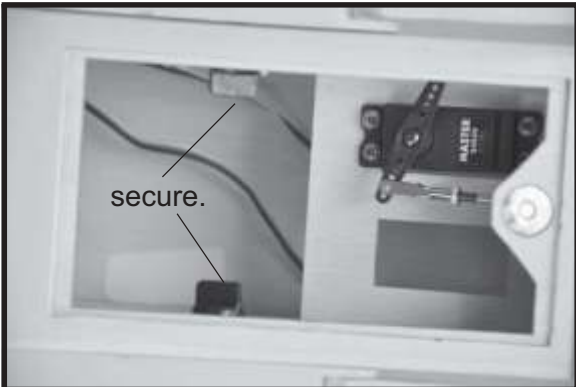
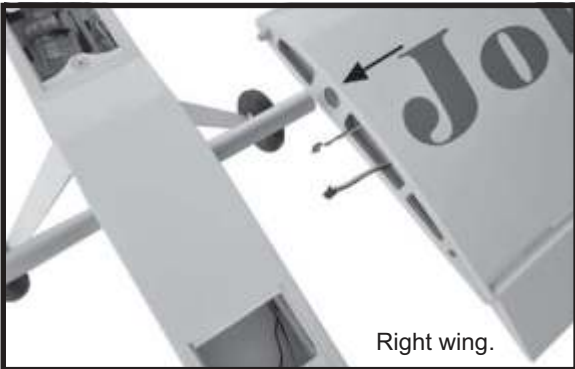
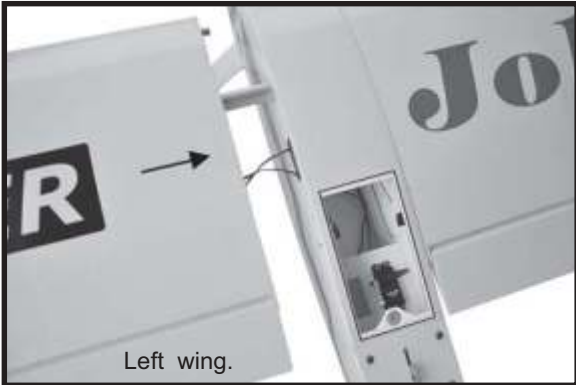

BALANCING.

1) It is critical that your airplane be balanced correctly. Improper balance will cause your plane to lose control and crash.

THE CENTER OF GRAVITY IS LOCATED **MM** BACK FROM THE LEADING EDGE OF THE WING.

2) Mount the wing to the fuselage. Using a couple of pieces of masking tape, place them on the top side of the wing **mm** back from the leading edge, at the fuselage sides.

3. Turn the airplane upside down. Place your fingers on the masking tape and carefully lift the plane .

Accurately mark the balance point on the top of the wing on both sides of the fuselage. The balance point is located **mm** back from the leading edge. This is the balance point at which your model should balance for your first flights. Later, you may wish to experiment by shifting the balance up to 10mm forward or back to change the flying characteristics. Moving the balance forward may improve the smoothness and arrow- like tracking, but it may then require more speed for take off and make it more difficult to slow down for landing. Moving the balance aft makes the model more agile with a lighter and snappier "feel". In any case, please start at the location we recommend .

With the wing attached to the fuselage, all parts of the model installed (ready to fly), and empty fuel tanks, hold the model at the marked balance point with the stabilizer level.

Lift the model. If the tail drops when you lift, the model is "tail heavy" and you must add weigh* to the nose. If the nose drops, it is "nose heavy" and you must add weight* to the tail to balance.

*If possible, first attempt to balance the model by changing the position of the receiver battery and receiver. If you are unable to obtain good balance by doing so, then it will be necessary to add weight to the nose or tail to achieve the proper balance point.

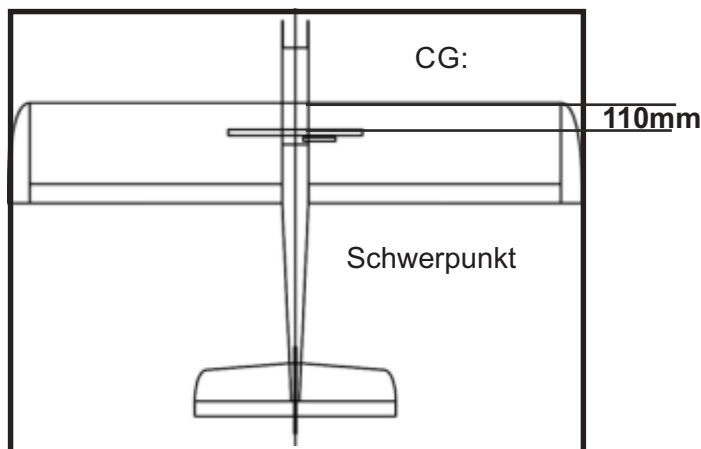

CONTROL THROWS.

The ideal C.G. is located 110mm from front leading edge.

Der ideale Schwerpunkt befindet sich 110mm hinter der Tragflächenvorderkante

- 1) The control throws should be measured at the widest point of each control sur-
- 2) Check to be sure the control surfaces move in the correct directions.

