

**CCG15-24-\*\*\*S**

**RELIABILITY DATA**

信頼性データ

## INDEX

	PAGE
1. MTBF計算値    Calculated Values of MTBF .....	3
2. 部品デレーティング    Components Derating .....	5
3. 主要部品温度上昇値    Main Components Temperature Rise $\Delta T$ List .....	7
4. 出力デレーティング    Output Derating .....	9
5. アブノーマル試験    Abnormal Test .....	12
6. 振動試験    Vibration Test .....	15
7. ノイズシミュレート試験    Noise Simulate Test .....	17
8. はんだ耐熱性試験    Resistance to Soldering Heat Test .....	19
9. 熱衝撃試験    Thermal Shock Test .....	20
10. 高温加湿通電試験    High Temperature and High Humidity Bias Test .....	22

\* 試験結果は、代表データではありますが、全ての製品はほぼ同等な特性を示します。

従いまして、以下の結果は参考値とお考え願います。

Test results are typical data. Nevertheless the following results are considered to be reference data because all units have nearly the same characteristics.

## 1. MTBF計算値 Calculated Values of MTBF

MODEL : CCG15-24-05S, CCG15-24-12S

### (1) 算出方法 Calculating Method

Telcordiaの部品ストレス解析法(\*1)で算出されています。

故障率 $\lambda_{ss}$ は、それぞれの部品ごとに電気ストレスと動作温度によって決定されます。

Calculated based on parts stress reliability projection of Telcordia(\*1).

Individual failure rate  $\lambda_{ss}$  is calculated by the electric stress and temperature rise of the each device.

\*1: Telcordia document “Reliability Prediction Procedure for Electronic Equipment”  
(Document number SR-332, Issue3)

$$\text{<算出式> } MTBF = \frac{1}{\lambda_{equip}} = \frac{1}{\pi_E \sum_{i=1}^m N_i \cdot \lambda_{ssi}} \times 10^9 \text{ 時間 (hours)}$$

$$\lambda_{ssi} = \lambda_{Gi} \cdot \pi_{Qi} \cdot \pi_{Si} \cdot \pi_{Ti}$$

- $\lambda_{equip}$  : 全機器故障率 (FITs)  
Total Equipment failure rate (FITs = Failures in  $10^9$  hours)
- $\lambda_{Gi}$  : i番目の部品に対する基礎故障率  
Generic failure rate for the  $i$ th device
- $\pi_{Qi}$  : i番目の部品に対する品質ファクタ  
Quality factor for the  $i$ th device
- $\pi_{Si}$  : i番目の部品に対するストレスファクタ  
Stress factor for the  $i$ th device
- $\pi_{Ti}$  : i番目の部品に対する温度ファクタ  
Temperature factor for the  $i$ th device
- $m$  : 異なる部品の数  
Number of different device types
- $N_i$  : i番目の部品の個数  
Quantity of  $i$ th device type
- $\pi_E$  : 機器の環境ファクタ  
Equipment environmental factor

**(2) MTBF値 MTBF Values**

条件 Conditions

・入力電圧 : 24VDC  
Input Voltage

・環境ファクタ : GF (Ground, Fixed)  
Environmental Factor

**(2)-1 CCG15-24-05S** Ambient temperature vs. MTBF

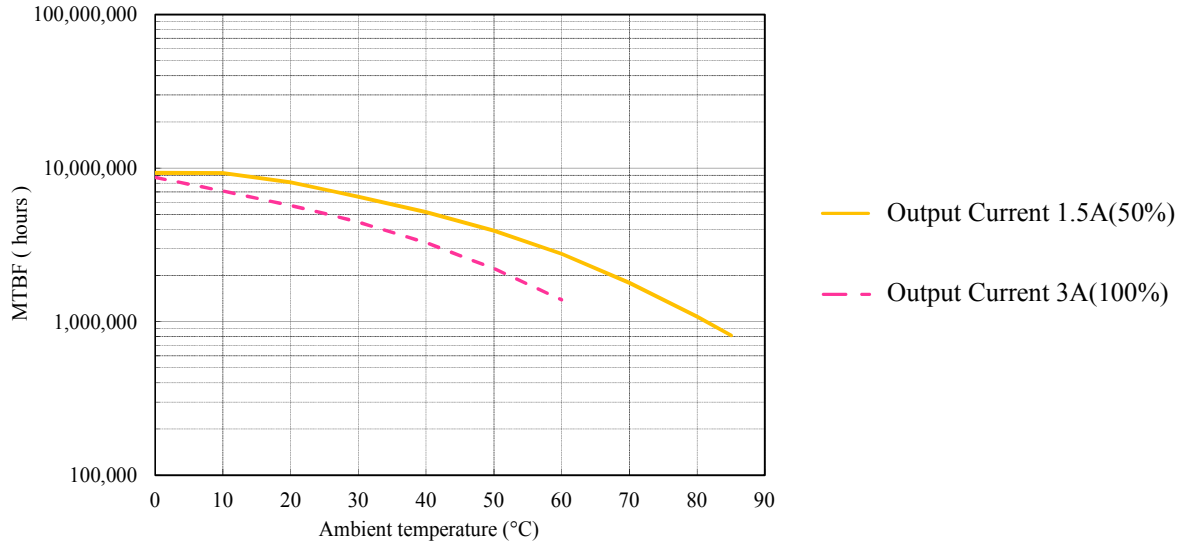

Ambient temperature	MTBF	
	Output Current 1.5A(50%)	Output Current 3A(100%)
25°C	7,270,867(hours)	5,072,046(hours)
40°C	5,172,769(hours)	3,275,261(hours)
60°C	2,761,982(hours)	1,386,830(hours)
85°C	815,615(hours)	-

**(2)-2 CCG15-24-12S** Ambient temperature vs. MTBF

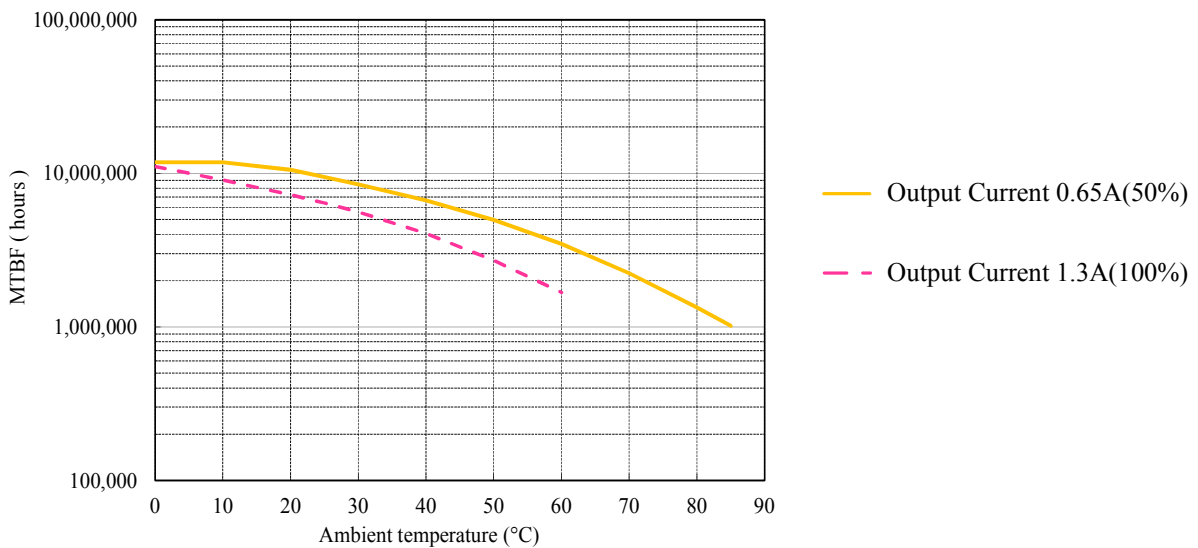

Ambient temperature	MTBF	
	Output Current 0.65A(50%)	Output Current 1.3A(100%)
25°C	9,457,627(hours)	6,400,441(hours)
40°C	6,661,479(hours)	4,057,177(hours)
60°C	3,478,017(hours)	1,673,540(hours)
85°C	1,015,677(hours)	-

## 2. 部品デレーティング Components Derating

MODEL : CCG15-24-05S, CCG15-24-12S

### (1) 算出方法 Calculating Method

#### (a) 測定方法 Measuring method

・入力電圧	: 24VDC	・出力電流	: 5V 3A(100%)
Input Voltage		Output Current	: 12V 1.3A(100%)
・周囲温度	: 60°C	・冷却法	: 自然空冷
Ambient Temperature		Cooling	: Natural convection
・取り付け	: 水平置き		
Mounting	: Horizontal		

#### (b) 半導体 Semiconductors

ケース温度、消費電力、熱抵抗より使用状態の接合点温度を求め最大定格、接合点温度との比較を求めました。

Compared with maximum junction temperature and actual one which is calculated based on case temperature, power dissipation and thermal impedance.

#### (c) IC、抵抗、コンデンサ等 IC, Resistors, Capacitors, etc.

周囲温度、使用状態、消費電力など、個々の値は設計基準内に入っています。

Ambient temperature, operating condition, power dissipation and so on are within derating criteria.

#### (d) 熱抵抗算出方法 Calculating method of thermal impedance

$$\theta_{j-c} = \frac{T_j(\max) - T_c}{P_j(\max)} \quad \theta_{j-a} = \frac{T_j(\max) - T_a}{P_j(\max)} \quad \theta_{j-l} = \frac{T_j(\max) - T_l}{P_j(\max)}$$

$T_c$  : デレーティングの始まるケース温度 一般に25°C  
Case Temperature at Start Point of Derating; 25°C in General

$T_a$  : デレーティングの始まる周囲温度 一般に25°C  
Ambient Temperature at Start Point of Derating; 25°C in General

$T_l$  : デレーティングの始まるリード温度 一般に25°C  
Lead Temperature at Start Point of Derating; 25°C in General

$P_j(\max)$  : 最大接合点(チャンネル)損失  
( $P_{ch}(\max)$ ) Maximum Junction (channel) Dissipation

$T_j(\max)$  : 最大接合点(チャンネル)温度  
( $T_{ch}(\max)$ ) Maximum Junction (channel) Temperature

$\theta_{j-c}$  : 接合点(チャンネル)からケースまでの熱抵抗  
( $\theta_{ch-c}$ ) Thermal Impedance between Junction (channel) and Case

$\theta_{j-a}$  : 接合点から周囲までの熱抵抗  
( $\theta_{ch-a}$ ) Thermal Impedance between Junction (channel) and Air

$\theta_{j-l}$  : 接合点からリードまでの熱抵抗  
( $\theta_{ch-l}$ ) Thermal Impedance between Junction (channel) and Lead

## (2) 部品デレーティング表 Components Derating List

## (2)-1 CCG15-24-05S

部品番号 Location No.	部品名 Part Name	最大定格 Maximum Rating	使用状態 Actual Rating	デレーティング率 Derating Factor
Q1	CHIP MOS FET	Tj(max):150°C	Tj:98.2°C	65.5%
Q101	CHIP MOS FET	Tj(max):150°C	Tj:92.3°C	61.6%
Q102	CHIP TRANSISTOR	Tj(max):150°C	Tj:96.3°C	64.2%
D2	CHIP FRD	Tj(max):150°C	Tj:97.7°C	65.2%
D102	CHIP FRD	Tj(max):150°C	Tj:94.3°C	62.9%
D103	CHIP FRD	Tj(max):150°C	Tj:95.7°C	63.8%
A1	CHIP IC	Tj(max):150°C	Tj:103.9°C	69.2%
A2	CHIP IC	Tj(max):150°C	Tj:93.6°C	62.4%
PC1	CHIP COUPLER	Tj(max):125°C	Tj:87.2°C	69.7%

## (2)-2 CCG15-24-12S

部品番号 Location No.	部品名 Part Name	最大定格 Maximum Rating	使用状態 Actual Rating	デレーティング率 Derating Factor
Q1	CHIP MOS FET	Tj(max):150°C	Tj:98.5°C	65.6%
D2	CHIP FRD	Tj(max):150°C	Tj:92.1°C	61.4%
D101	CHIP SBD	Tj(max):150°C	Tj:104.9°C	70.0%
A1	CHIP IC	Tj(max):150°C	Tj:99.0°C	66.0%
A2	CHIP IC	Tj(max):150°C	Tj:89.8°C	59.9%
PC1	CHIP COUPLER	Tj(max):125°C	Tj:88.1°C	70.5%

3. 主要部品温度上昇値 Main Components Temperature Rise  $\Delta T$  List

MODEL : CCG15-24-05S, CCG15-24-12S

(1) 測定条件 Measuring Conditions

測定方法 Measuring Method	取り付け : 水平置き Mounting Horizontal  冷却法 : 自然空冷 Cooling Natural convection  <div style="text-align: center;"> </div>
--------------------------	--

モデル Model	CCG 15-24-05S	CCG 15-24-12S
入力電圧 Input Voltage	24VDC	
出力電圧 Output Voltage	5V	12V
出力電流 Output Current	3A (100%)	1.3A (100%)
周囲温度 Ambient Temperature	60°C	

## (2) 測定結果 Measuring Results

## (2)-1 CCG15-24-05S

部品番号 Location No.	部品名 Part Name	温度上昇値 $\Delta T$ (°C) Temperature Rise
Q1	CHIP MOS FET	35.7
Q101	CHIP MOS FET	30.9
Q102	CHIP TRANSISTOR	35.4
D2	CHIP FRD	35.3
D102	CHIP FRD	34.3
D103	CHIP FRD	34.3
A1	CHIP IC	34.9
A2	CHIP IC	33.5
PC1	CHIP COUPLER	26.8
L1	CHOKE COIL	29.3
L101	CHOKE COIL	26.5
T1	TRANS,PULSE	27.8
T2	TRANS,PULSE	43.7

## (2)-2 CCG15-24-12S

部品番号 Location No.	部品名 Part Name	温度上昇値 $\Delta T$ (°C) Temperature Rise
Q1	CHIP MOS FET	36.3
D2	CHIP FRD	30.4
D101	CHIP SBD	33.4
A1	CHIP IC	30.0
A2	CHIP IC	29.8
PC1	CHIP COUPLER	27.8
L1	CHOKE COIL	30.2
L101	CHOKE COIL	28.2
T2	TRANS,PULSE	35.8



### 4. 出力デレーティング Output Derating

MODEL : CCG15-24-\*\*S

#### (1) 測定条件 Measuring Conditions

測定方法 Measuring Method	取り付け : 水平置き Mounting Horizontal  冷却法 : 自然空冷 Cooling Natural convection			
	取り付け : 垂直置き Mounting Vertically  冷却法 : 強制空冷 Cooling Forced air cooling			

モデル Model	CCG15-24-03S	CCG15-24-05S	CCG15-24-12S	CCG15-24-15S
出力電圧 Output Voltage	3.3V	5V	12V	15V
入力電圧 Input Voltage	9VDC, 12VDC, 24VDC, 36VDC			
風速 Air Velocity	0.5m/s, 1.0m/s, 1.5m/s, 2.0m/s			

(2) 測定結果 Measuring Results

(2)-1 CCG15-24-03S

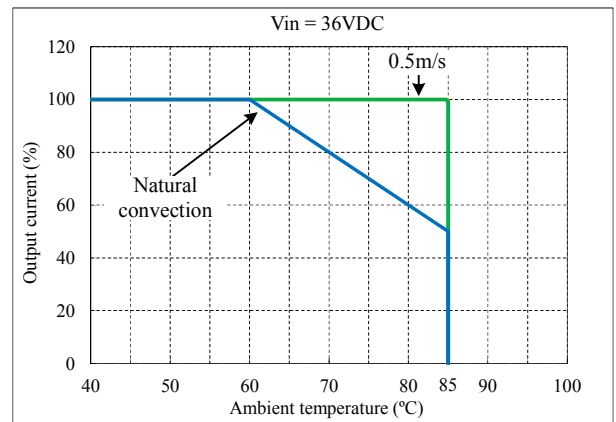
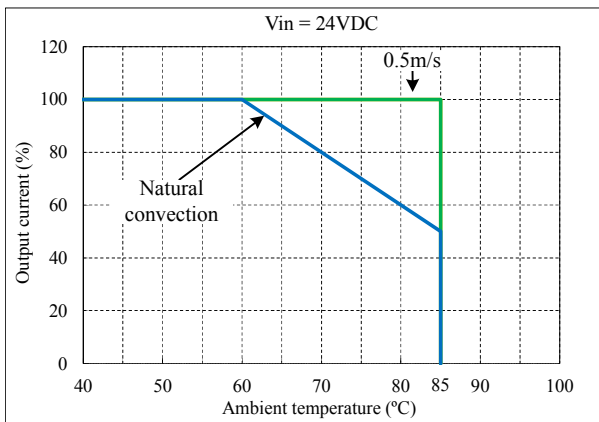
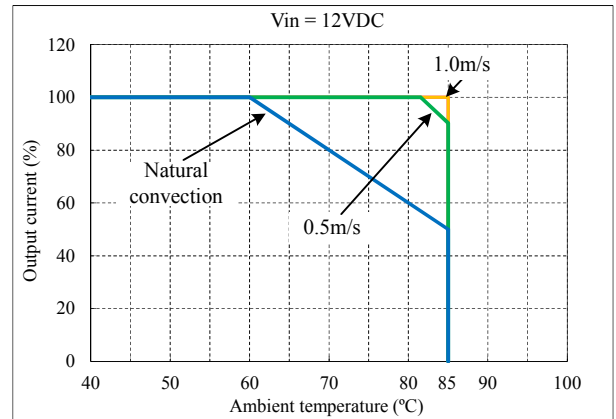
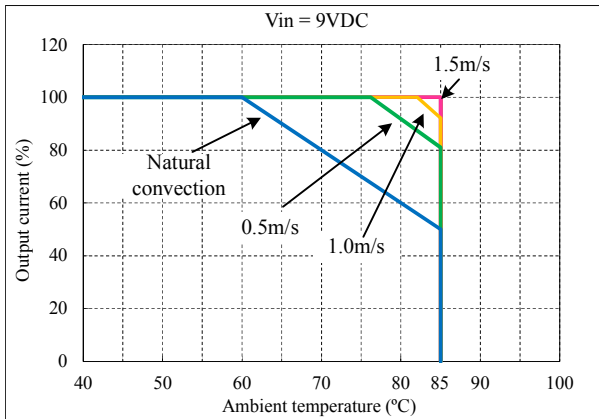

(2)-2 CCG15-24-05S

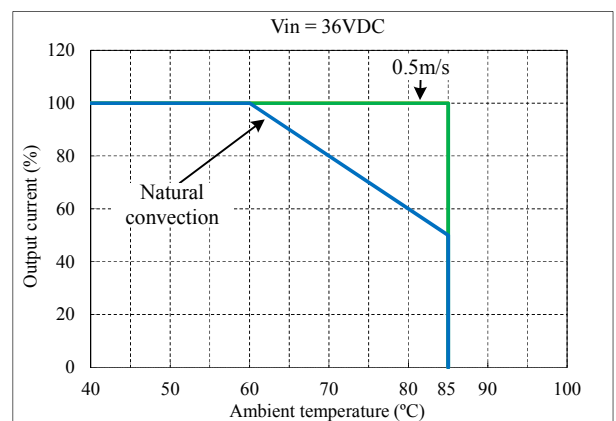
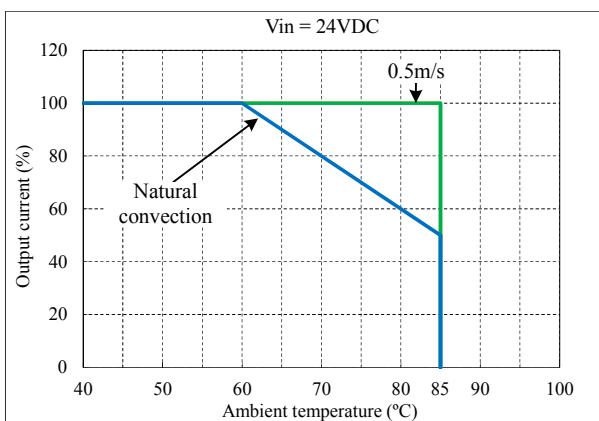
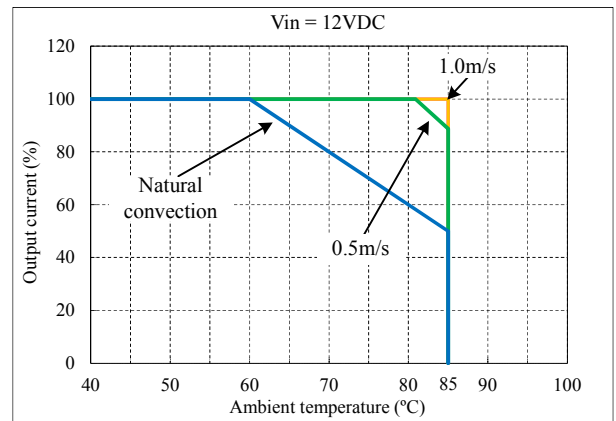
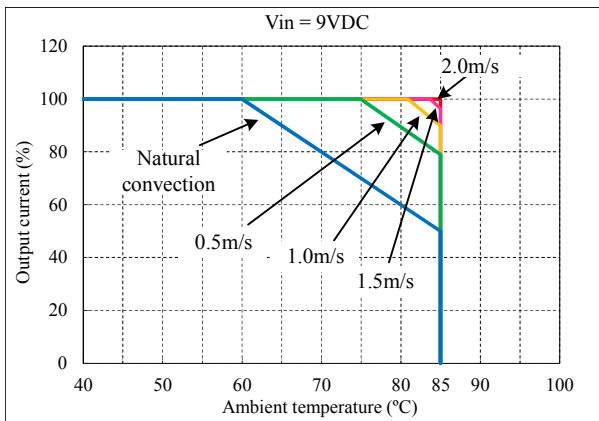

(2)-3 CCG15-24-12S

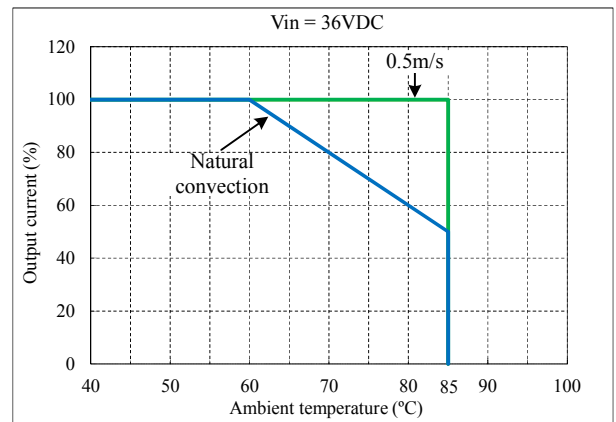
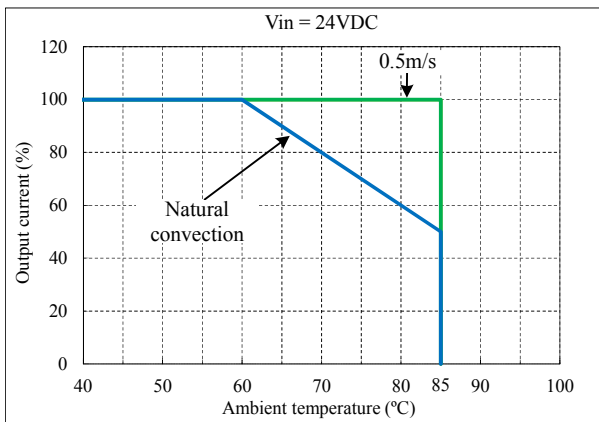
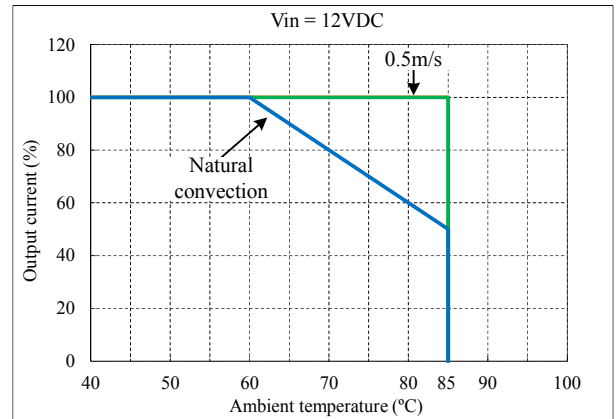
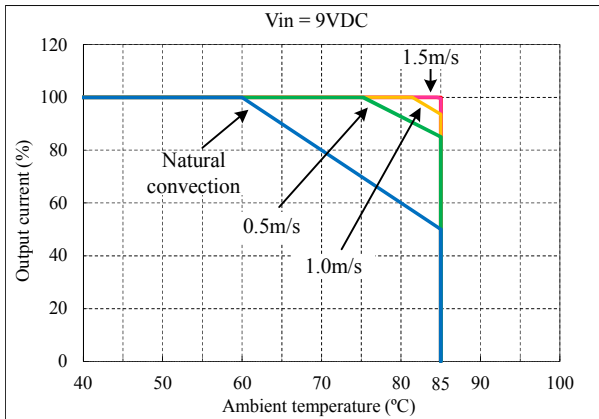

(2)-4 CCG15-24-15S

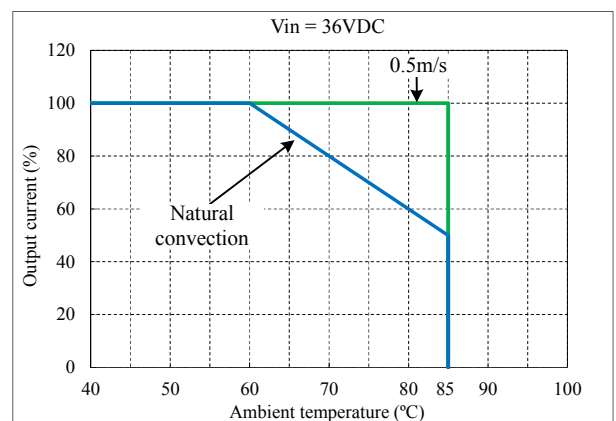
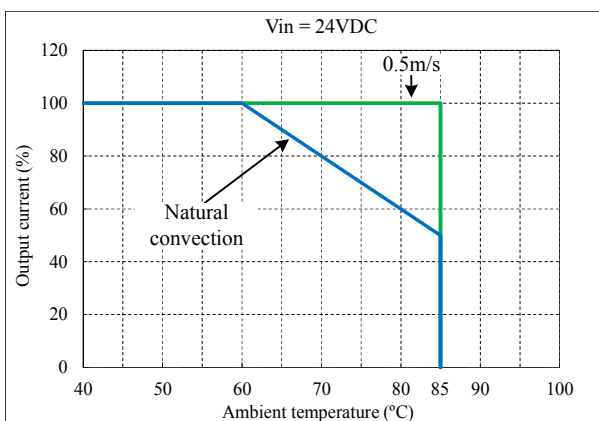
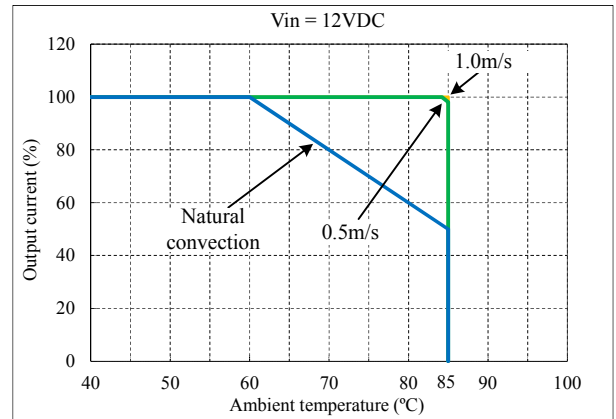
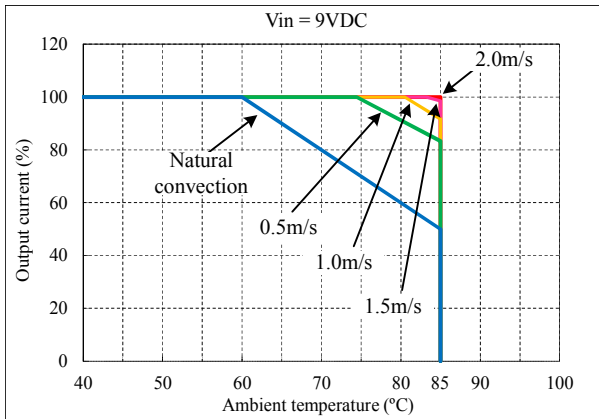

5. アブノーマル試験 Abnormal Test

MODEL : CCG15-24-05S, CCG15-24-12S

(1) 試験条件及び回路 Test Condition and Circuit

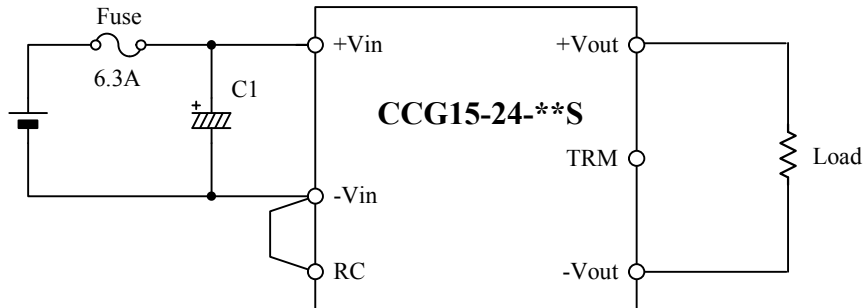

- 入力電圧 : 36VDC
- Input Voltage
- 出力電流 : 5V 3A(100%)
- Output Current 12V 1.3A(100%)
- 周囲温度 : 25°C
- Ambient Temperature
- 電解コンデンサ(C1) : 50V 120μF
- Electrolytic Cap.

(2) 試験結果 Test Results

(2)-1 CCG15-24-05S

(Da:Damaged)

No.	Test position		Test mode		Test result													記事 Note
	部品No. Location No.	試験端子 Test point	ショート Short	オープン Open	a 発火 Fire	b 発煙 Smoke	c 破裂 Burst	d 異臭 Smell	e 赤熱 Red hot	f 破損 Damaged	g ヒューズ断 Fuse blown	h OVP	I OCP	j 出力断 No output	k 変化なし No change	l その他 Others		
1	Q1	G-D	●							●	●			●			Da:Q1,R35	
2		G-S	●											●				
3		D-S	●											●				
4		G		●						●	●			●				Da:Q1
5		D		●										●				
6		S		●										●				
7	Q101	G-D	●										●					
8		G-S	●													●	効率低下 Efficiency down	
9		D-S	●											●				
10		G		●										●				
11		D		●										●				
12		S		●										●				
13	Q3	B-C	●							●						●	Da:Z1 効率低下 Efficiency down	
14		B-E	●												●			
15		C-E	●													●	効率低下 Efficiency down	
16		B		●											●			
17		C		●											●			
18		E		●											●			

No.	Test position		Test mode		Test result													記事 Note	
	部品No. Location No.	試験端子 Test point	ショート Short	オープン Open	a 発火 Fire	b 発煙 Smoke	c 破裂 Burst	d 異臭 Smell	e 赤熱 Red hot	f 破損 Damaged	g ヒューズ断 Fuse blown	h OVP	i OCP	j 出力断 No output	k 変化なし No change	l その他 Others			
19	Q102A	B-C	●													●	効率低下 Efficiency down 出力リップル増加 Output ripple increase		
20		B-E	●														●	効率低下 Efficiency down	
21		C-E	●														●		
22		B		●														●	効率低下 Efficiency down
23		C		●														●	効率低下 Efficiency down
24		E		●														●	効率低下 Efficiency down
25	Q102B	B-C	●														●	効率低下 Efficiency down	
26		B-E	●														●	効率低下 Efficiency down	
27		C-E	●														●	効率低下 Efficiency down	
28		B		●													●		
29		C		●													●		
30	E		●													●			
31	D2	A-K	●						●								●	Da:R14,R15,Q3,Z1 効率低下 Efficiency down	
32		A/K		●													●	効率低下 Efficiency down	
33	D102	A-K	●														●	出力電圧上昇 Output voltage increase	
34		A/K		●													●		
35	D103	A-K	●														●		
36		A/K		●													●	効率低下 Efficiency down	
37	L1		●														●		
38				●													●		
39	L101		●														●	出力リップル増加 Output ripple increase	
40				●													●		
41	T1	1-2	●														●	効率低下 Efficiency down	
42		3-4	●														●	効率低下 Efficiency down	
43		1		●													●	効率低下 Efficiency down	
44		2		●													●	効率低下 Efficiency down	
45		3		●													●	効率低下 Efficiency down	
46		4		●													●	効率低下 Efficiency down	
47	T2	1-2	●								●					●			
48		2-3	●													●			
49		3-4	●														●		
50		4-5	●								●					●			
51		6-7	●														●		
52		7-8	●													●			
53		8-9	●														●		
54		9-10	●														●		
55		1		●													●	効率低下 Efficiency down	
56		2		●													●		
57		3		●													●	効率低下 Efficiency down	
58		4		●													●	効率低下 Efficiency down	
59		5		●													●	効率低下 Efficiency down	
60		6		●													●	効率低下 Efficiency down	
61		7		●													●	効率低下 Efficiency down	
62		8		●													●	効率低下 Efficiency down	
63		9		●													●	効率低下 Efficiency down	
64		10		●													●		

(2)-2 CCG15-24-12S

(Da:Damaged)

No.	Test position		Test mode		Test result											記事 Note	
	部品No. Location No.	試験端子 Test point	ショート Short	オープン Open	a 発火 Fire	b 発煙 Smoke	c 破裂 Burst	d 異臭 Smell	e 赤熱 Red hot	f 破損 Damaged	g ヒューズ断 Fuse blown	h OVP	i OCP	j 出力断 No output	k 変化なし No change		l その他 Others
1	Q1	G-D	●						●	●				●		Da:Q1,R35	
2		G-S	●											●			
3		D-S	●								●			●			
4		G		●						●	●			●		Da:Q1	
5		D		●										●			
6		S		●										●			
7	Q3	B-C	●						●						●	Da:Z1 効率低下 Efficiency down	
8		B-E	●											●			
9		C-E	●												●	効率低下 Efficiency down	
10		B		●											●		
11		C		●											●		
12	E		●											●			
13	D2	A-K	●						●						●	Da:R14,R15,Q3,Z1 効率低下 Efficiency down	
14		A/K		●											●	効率低下 Efficiency down	
15	D101	A-K	●									●					
16		A/K		●										●			
17	L1		●												●		
18				●											●		
19	L101		●												●	出力リップル増加 Output ripple increase	
20				●											●		
21	T2	1-2	●							●				●			
22		2-3	●									●					
23		3-4	●												●		
24		4-5	●								●			●			
25		6-7	●												●		
26		7-8	●												●		
27		8-9	●										●				
28		9-10	●												●		
29		1		●												●	効率低下 Efficiency down
30		2		●											●		
31	3		●												●	効率低下 Efficiency down	
32	4		●												●	効率低下 Efficiency down	
33	5		●												●	効率低下 Efficiency down	
34	6		●												●	効率低下 Efficiency down	
35	7		●												●	効率低下 Efficiency down	
36	8		●												●		
37	9		●												●	効率低下 Efficiency down	
38	10		●												●	効率低下 Efficiency down	

## 6. 振動試験 Vibration Test

MODEL : CCG15-24-05S

### (1) 振動試験種類 Vibration Test Class

掃引振動数耐久試験 Frequency variable endurance test

### (2) 使用振動試験装置 Equipment Used

EMIC (株) 製 試験装置 F-16000BDH/LA16AW  
EMIC CORP. Test Equipment

### (3) 供試品台数 The Number of D.U.T. (Device Under Test)

CCG15-24-05S : 1台 (unit)

### (4) 試験条件 Test Conditions

・周波数範囲	: 10~55Hz	・振動方向	: X, Y, Z
Sweep Frequency		Direction	
・掃引時間	: 3.0分間	・振幅	: 1.52mm (一定)
Sweep Time	3.0min	Amplitude	(const.)
・試験時間	: 各方向共 1時間		
Test Time	1 hour each		

### (5) 試験方法 Test Method

供試品を基板に取り付け、それを取付台に固定する。

Fix the D.U.T. on the circuit board and fit it on the fitting-stage.

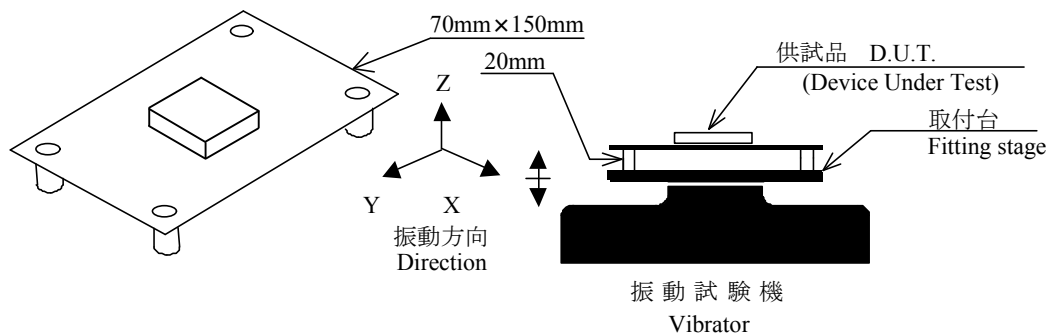

## (6) 試験結果 Test Results

合格 OK

## •試験条件 Test Conditions

入力電圧 : 24VDC

出力電流 : 3A(100%)

周囲温度 : 25°C

Input Voltage

Output Current

Ambient Temperature

測定確認項目 Check Item		試験前 Before Test	試験後 After Test
出力電圧 Output Voltage	V	4.996	4.996
効率 Efficiency	%	87.4	87.3
出力リップルノイズ電圧 Output Ripple and Noise Voltage	mVp-p	9.4	9.0
入力変動 Line Regulation	mV	1.5	1.3
負荷変動 Load Regulation	mV	6.9	8.0
耐電圧 Withstand Voltage	-	異常無し OK	異常無し OK
外観 Appearance	-	異常無し OK	異常無し OK



## 7. ノイズシミュレート試験 Noise Simulate Test

MODEL : CCG15-24-\*\*S

## (1) 試験回路及び測定器 Test Circuit and Equipment

A. 入力ポート : +Vin、-Vinに同時に印加

Input Port : Apply to +Vin and -Vin at the same time.

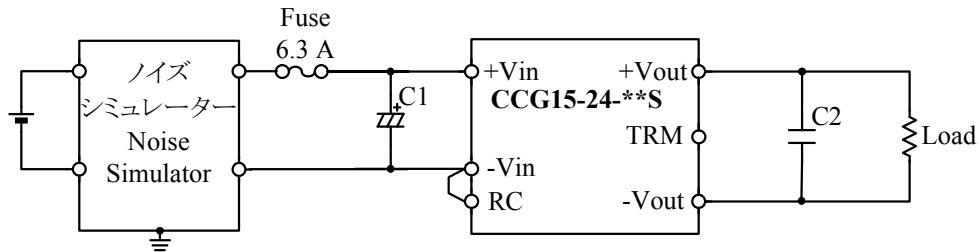

B-1. 信号ポート : (RC, -Vin)に印加

Signal Port : Apply to (RC, -Vin).

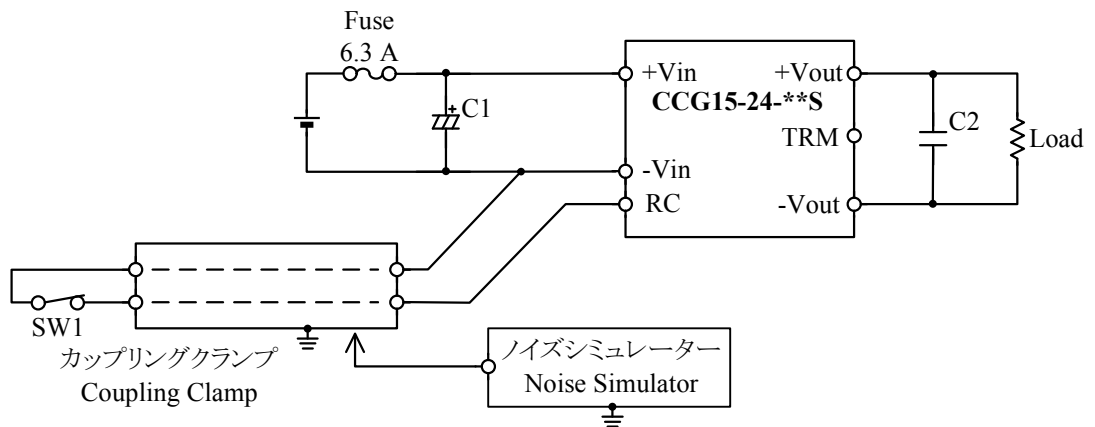

B-2. 信号ポート : (TRM, +Vout)、(TRM, -Vout)に印加

Signal Port : Apply to (TRM, +Vout) and (TRM, -Vout).

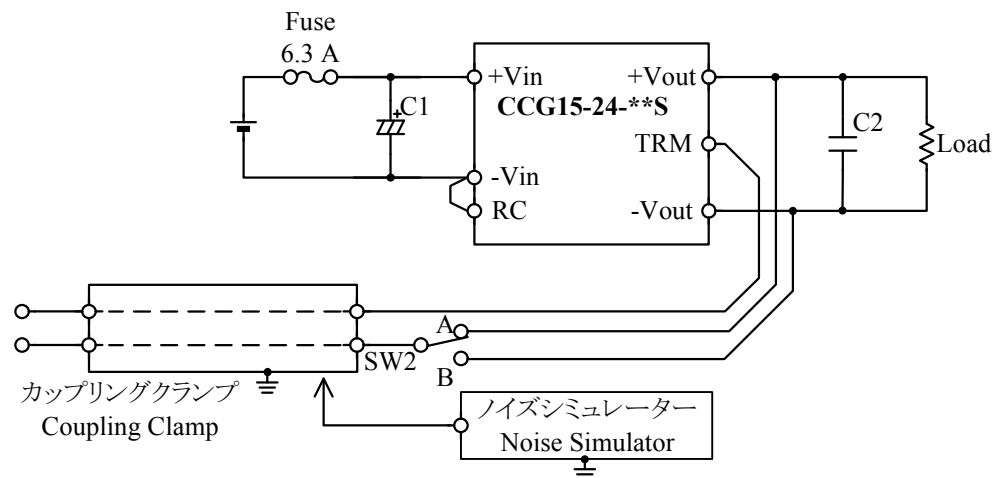

SW2

A : (TRM, +Vout)に印加  
Apply to (TRM, +Vout).B : (TRM, -Vout)に印加  
Apply to (TRM, -Vout).

- ・ノイズシミュレーター : INS-4320A (ノイズ研究所株式会社)  
Noise Simulator (Noise Laboratory Co. LTD)
- ・電解コンデンサ(C1) : 50V 120 $\mu$ F  
Electrolytic Cap.
- ・セラミックコンデンサ(C2) : 25V 22 $\mu$ F  
Ceramic Cap.

**(2) 試験条件 Test Conditions**

- ・入力電圧 : 24VDC  
Input Voltage
- ・出力電圧 : 定格  
Output Voltage Rated
- ・出力電流 : 0%, 100%  
Output Current
- ・周囲温度 : 25°C  
Ambient Temperature
- ・パルス幅 : 50~1000ns  
Pulse Width
- ・トリガ選択 : Line  
Trigger Select
- ・ノイズ電圧 : 入力ポート 0~2kV  
Noise Level Input Port
- 信号ポート 0~750V  
Signal Port
- ・極性 : +, -  
Polarity
- ・印加モード : 入力ポート ノーマル  
Mode Input Port Normal
- 信号ポート コモン  
Signal Port Common

**(3) 供試品台数 The Number of D.U.T (Device Under Test)**

- |              |           |              |           |
|--------------|-----------|--------------|-----------|
| CCG15-24-03S | 1台 (unit) | CCG15-24-12S | 1台 (unit) |
| CCG15-24-05S | 1台 (unit) | CCG15-24-15S | 1台 (unit) |

**(4) 判定条件 Acceptable Conditions**

1. 試験中、5%を超える出力電圧の変動のない事  
The regulation of output voltage must not exceed 5% of initial value during test.
2. 試験後の出力電圧は初期値から変動していない事  
The output voltage must be within the regulation of specification after the test.
3. 発煙・発火のない事  
Smoke and fire are not allowed.

**(5) 試験結果 Test Results**

CCG15-24-03S	合格 OK
CCG15-24-05S	合格 OK
CCG15-24-12S	合格 OK
CCG15-24-15S	合格 OK

## 8. はんだ耐熱性試験 Resistance to Soldering Heat Test

MODEL : CCG15-24-05S

## (1) 使用装置 Machine Used

自動はんだ付け装置 : TLC-350XIV (セイテック)  
Automatic Dip Soldering Machine (SEITEC)

## (2) 供試品台数 The Number of D.U.T. (Device Under Test)

CCG15-24-05S : 1台 (unit)

## (3) 試験条件 Test Conditions

・溶融半田温度 : 260°C	・予備加熱温度 : 125°C
Dip Soldering Temperature	Pre-heating Temperature
・浸漬保持時間 : 10 秒間	・予備加熱時間 : 60 秒間
Dip time 10 seconds	Pre-heating Time 60 seconds

## (4) 試験方法 Test Method

初期測定の後、供試体を基板にのせ、自動はんだ付装置でフラックス浸漬、予備加熱、はんだ付を行う。常温常湿下に1時間放置し、出力に異常がないことを確認する。

Check if there is no abnormal output before test. Then fix the D.U.T. on a circuit board, transfer to flux-dipping, preheat and solder in the automatic dip soldering machine. Leave it for 1 hour at the room temperature, then check if there is no abnormal output.

## (5) 試験結果 Test Results

合格 OK

## ・試験条件 Test conditions

入力電圧 : 24VDC	出力電流 : 3A(100%)	周囲温度 : 25°C
Input Voltage	Output Current	Ambient Temperature

測定確認項目 Check Item		試験前 Before Test	試験後 After Test
出力電圧 Output Voltage	V	4.998	4.998
効率 Efficiency	%	87.3	87.4
出力リップルノイズ電圧 Output Ripple and Noise Voltage	mVp-p	7.3	7.4
入力変動 Line Regulation	mV	0.8	0.9
負荷変動 Load Regulation	mV	6.9	8.4
耐電圧 Withstand Voltage	-	異常無し OK	異常無し OK
外観 Appearance	-	異常無し OK	異常無し OK

## 9. 熱衝撃試験 Thermal Shock Test

MODEL : CCG15-24-05S

### (1) 使用冷熱衝撃装置 Equipment Used (Thermal Shock Chamber)

ESPEC(株) 製 TSA-102ES-W  
ESPEC CORP.

### (2) 供試体台数 The Number of D.U.T. (Device Under Test)

CCG15-24-05S : 5台 (units)

### (3) 試験条件 Test Conditions

- ・電源周囲温度 : -40°C ⇔ 125°C  
Ambient Temperature
- ・試験時間 : 30min ⇔ 30min  
Test Time
- ・試験サイクル : 500、750 サイクル  
Test Cycle 500, 750 Cycles
- ・非動作  
Not Operating

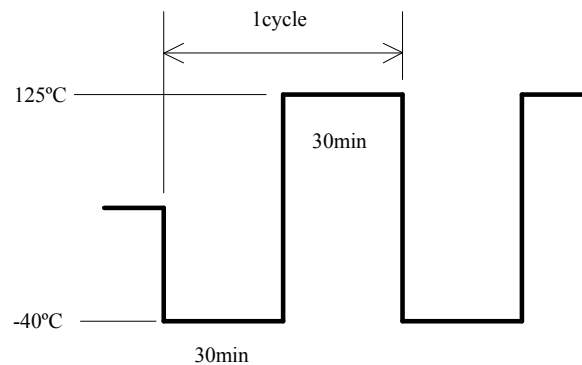

### (4) 試験方法 Test Method

初期測定の後、供試品を試験槽に入れ、上記サイクルで試験を行う。500、750サイクル後に、供試品を常温常湿下に1時間放置し、出力に異常がない事を確認する。

Before testing, check if there is no abnormal output, then put the D.U.T. in testing chamber, and test it according to the above cycle. 500, 750 cycles later, leave it for 1 hour at the room temperature, then check if there is no abnormal output.

### (5) 試験結果 Test Results

合格 OK

測定データは次項に示す。

See next page for measuring data.

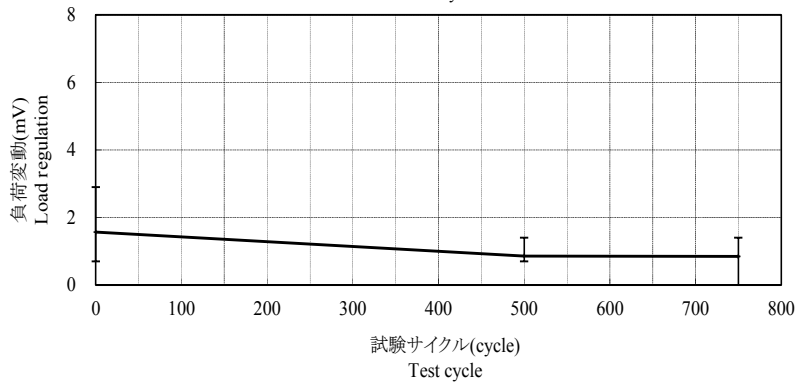
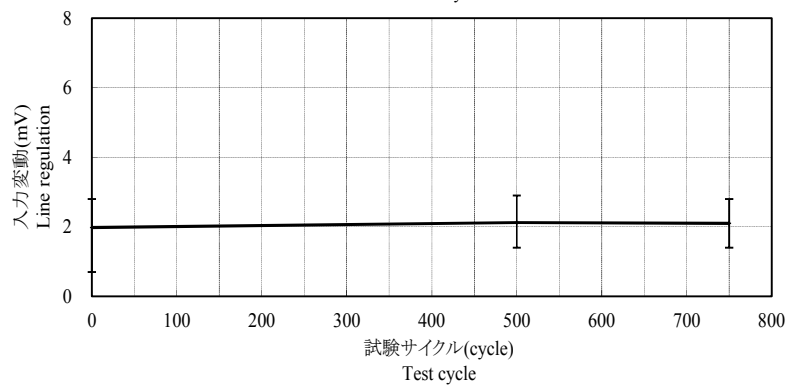
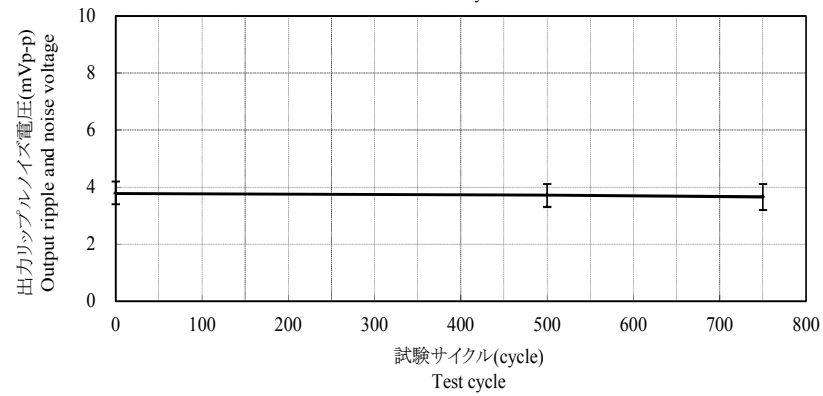
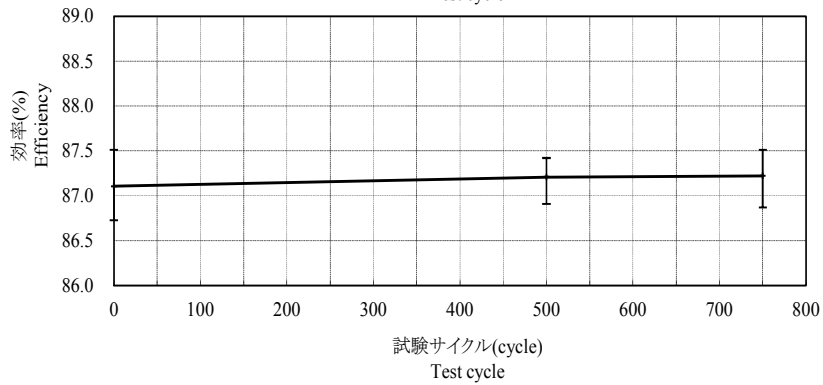
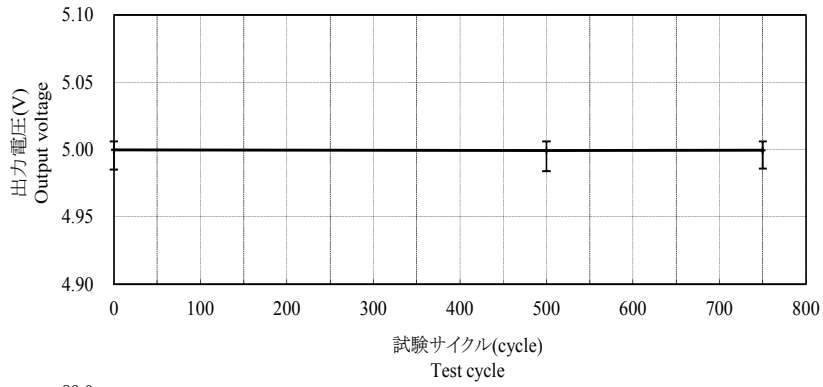

## 10. 高温加湿通電試験 High Temperature and High Humidity Bias Test

MODEL : CCG15-24-05S

### (1) 使用計測器 Equipment Used

TEMP.&HUMID. CHAMBER PR-1KH (ESPEC CORP.)

### (2) 供試体台数 The Number of D.U.T. (Device Under Test)

CCG15-24-05S : 1台 (unit)

### (3) 試験条件 Test Conditions

- ・周囲温度 : 85°C  
Ambient Temperature
- ・湿度 : 85%  
Humidity
- ・試験時間 : 500 時間  
Test time 500 hours
- ・入力電圧 : 0VDC ⇔ 24VDC  
Input Voltage
- ・出力電圧 : 定格  
Output Voltage Rated
- ・出力電流 : 0A (0%)  
Output Current

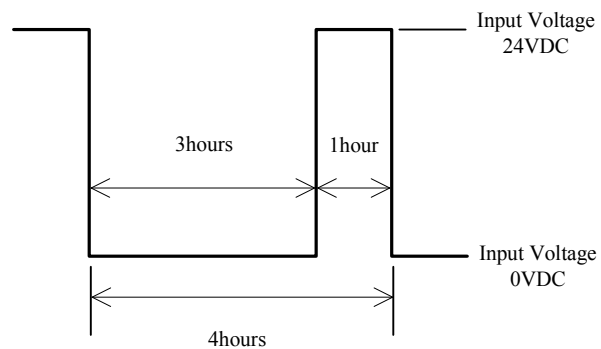

### (4) 試験方法 Test Method

初期測定の後、供試体を試験槽に入れ、槽の温度を室温(25°C)から周囲温度が規定温度(85°C)になるまで徐々に上げる。供試体を規定の条件にて500時間試験を行い、常温常湿下に1時間放置した後、出力に異常がない事を確認する。

Check if there is no abnormal output before test. Then fix the D.U.T. in testing chamber, and the ambient temperature is gradually increased from 25°C to 85°C. Test the D.U.T for 500 hours according to above conditions and leave D.U.T. for 1 hour at the room temperature, then check if there is no abnormal output.

## (5) 試験結果 Test Results

合格 OK

・試験条件 Test conditions

入力電圧 : 24VDC

出力電流 : 3A(100%)

周囲温度 : 25°C

Input Voltage

Output Current

Ambient Temperature

測定確認項目 Check Item		試験前 Before Test	試験後 After Test
出力電圧 Output Voltage	V	5.014	5.021
効率 Efficiency	%	87.5	87.5
出力リップルノイズ電圧 Output Ripple and Noise Voltage	mVp-p	10	10
入力変動 Line Regulation	mV	1.7	1.8
負荷変動 Load Regulation	mV	1.0	1.0
耐電圧 Withstand Voltage	-	異常無し OK	異常無し OK
外観 Appearance	-	異常無し OK	異常無し OK