

# DistanceMaster Vision



 **Laser**  
635 nm

**Laserliner**

DE 02

EN 14

NL 26

DA 38

FR 50

ES 62

IT

PL

FI

PT

SV

NO

TR

RU

UK

CS

ET

LV

LT

RO

BG

EL

**!** Lesen Sie die Bedienungsanleitung, das beiliegende Heft „Garantie- und Zusatzhinweise“ sowie die aktuellen Informationen und Hinweise im Internet-Link am Ende dieser Anleitung vollständig durch. Befolgen Sie die darin enthaltenen Anweisungen. Diese Unterlage ist aufzubewahren und bei Weitergabe des Gerätes mitzugeben.

## Funktion / Verwendung

Laser-Entfernungsmesser mit Kamerafunktion

- Messen von Längen, Flächen und Volumen
- Min/Max-Dauermessung, Wandflächenfunktion, Winkelfunktion, Pythagoras  $1 + 2 + 3$ , Additions- und Subtraktionsfunktion, digitale Libelle, Absteckfunktion und  $360^\circ$  Neigungssensor
- Kamerafunktion mit 8-fachem Digitalzoom und Viewfinder zum Anvisieren des Messbereichs

## Allgemeine Sicherheitshinweise

- Setzen Sie das Gerät ausschließlich gemäß dem Verwendungszweck innerhalb der Spezifikationen ein.
- Die Messgeräte und das Zubehör sind kein Kinderspielzeug. Vor Kindern unzugänglich aufbewahren.
- Umbauten oder Veränderungen am Gerät sind nicht gestattet, dabei erlischt die Zulassung und die Sicherheitsspezifikation.
- Setzen Sie das Gerät keiner mechanischen Belastung, enormen Temperaturen, Feuchtigkeit oder starken Vibrationen aus.
- Das Gerät darf nicht mehr verwendet werden, wenn eine oder mehrere Funktionen ausfallen oder die Batterieladung schwach ist.
- Dieses Gerät ist nur zum Laden von wiederaufladbaren Nickel-Metallhydrid (NiMH) Batterien (Akkus), Typ AAA 1,2V, konzipiert.
- Keinesfalls andere Batterien versuchen aufzuladen, da dies zur Zerstörung des Gerätes führen kann oder aber gefährliche Verletzungen beim Menschen nach sich ziehen kann.
- Jeweils nur wiederaufladbare Batterien (Akkus) der gleichen Größe, des gleichen Typs, gleicher Kapazität und vom gleichen Hersteller zusammen laden.
- Bitte beachten Sie die Sicherheitshinweise von lokalen bzw. nationalen Behörden zur sachgemäßen Benutzung des Gerätes.

## Sicherheitshinweise

Umgang mit Lasern der Klasse 2



Laserstrahlung!  
Nicht in den Strahl blicken!  
Laser Klasse 2  
< 1 mW · 635 nm  
EN 60825-1:2014

- Achtung: Nicht in den direkten oder reflektierten Strahl blicken.
- Den Laserstrahl nicht auf Personen richten.
- Falls Laserstrahlung der Klasse 2 ins Auge trifft, sind die Augen bewusst zu schließen und der Kopf sofort aus dem Strahl zu bewegen.
- Manipulationen (Änderungen) an der Lasereinrichtung sind unzulässig.
- Betrachten Sie den Laserstrahl oder die Reflektionen niemals mit optischen Geräten (Lupe, Mikroskop, Fernglas, ...).

## Sicherheitshinweise

Umgang mit elektromagnetischer Strahlung

- Das Messgerät hält die Vorschriften und Grenzwerte für die elektromagnetische Verträglichkeit gemäß EMV-Richtlinie 2014/30/EU ein.
- Lokale Betriebseinschränkungen, z.B. in Krankenhäusern, in Flugzeugen, an Tankstellen, oder in der Nähe von Personen mit Herzschrittmachern, sind zu beachten. Die Möglichkeit einer gefährlichen Beeinflussung oder Störung von und durch elektronische Geräte ist gegeben.
- Bei einem Einsatz in der Nähe von hohen Spannungen oder unter hohen elektromagnetischen Wechselfeldern kann die Messgenauigkeit beeinflusst werden.

## Wiederaufladbare Batterien einlegen

Das Batteriefach öffnen und wiederaufladbare Batterien (3 x NiMH, Typ AAA) gemäß den Installationssymbolen einlegen. Dabei auf korrekte Polarität achten. Die wiederaufladbare Batterien können mit dem beiliegenden USB-Ladekabel im Gerät geladen werden.

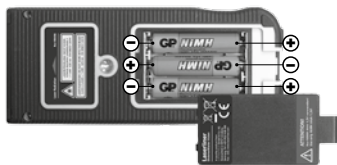

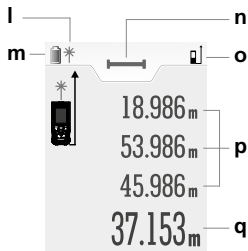
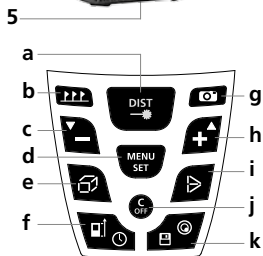

- 1 Laserempfängsfeld
- 2 Display
- 3 Anschlussbuchse für USB-Ladegerät
- 4 Batteriefach (Rückseite)
- 5 Klappbarer Pin
- 6 Laseraustritt
- 7 Kamera

## TASTATUR:

- a AN / Laser an / Messen / min/max-Dauermessung
- b Absteckfunktion
- c Subtraktionsfunktion / Wert verringern / gespeicherte Messwerte ansehen
- d Einstellungsmenü / Bestätigen
- e Länge / Fläche / Volumen / Wandflächenfunktion
- f Timerfunktion / Messebene (Referenz) vorne / Gewinde / hinten / Pin
- g Kamerafunktion
- h Additionsfunktion / Wert erhöhen / gespeicherte Messwerte ansehen
- i Winkelfunktion / Pythagoras 1 + 2 + 3
- j AUS / Löschen der letzten Messwerte
- k Speicher / digitale Libelle

## DISPLAY:

- l Laser aktiv
- m Batteriesymbol
- n Eingestellte Messfunktion
- o Messebene (Referenz) vorne / Gewinde / hinten / Pin
- p Zwischenwerte / min/max-Werte
- q Messwerte / Messergebnisse



## Einschalten, Messen und Ausschalten:

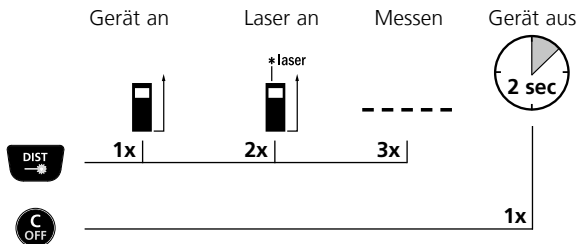

## Einstellungsmenü:

MENU SET		20 sec	Zeiteinstellung automatische Abschaltung der Display-Beleuchtung
		060 sec	Zeiteinstellung automatische Abschaltung Laser
		150 sec	Zeiteinstellung automatische Abschaltung Gerät
		on	Signalton ein / aus
		0.000 m	Messeinheit umschalten: m / ft / ' " / inch
		°	Messeinheit umschalten: ° / %



Einstellungsoption auswählen



Auswahl bestätigen (grüne Kennzeichnung)



Wert verändern



Einstellung bestätigen (rote Kennzeichnung)



Einstellung speichern (optional)



Menü verlassen

## Löschen des letzten Messwertes:



## Messebene (Referenz) umschalten:

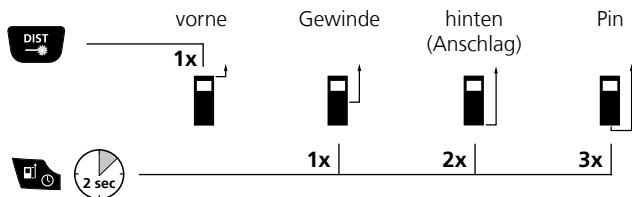

Das Gerät startet mit der letzten Einstellung.

## Messebene Pin / Anschlag:

Für Messungen aus der Ecke den Pin nach unten klappen und die Einstellung „Messebene PIN“ wählen.



Für Anschlagmessungen den Pin zur Seite klappen und die Einstellung „Messebene hinten“ wählen.



## Längenmessung:

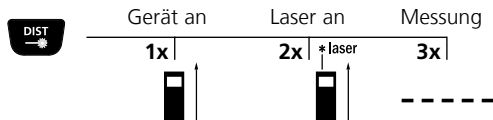

## Addition und Subtraktion von Längen:

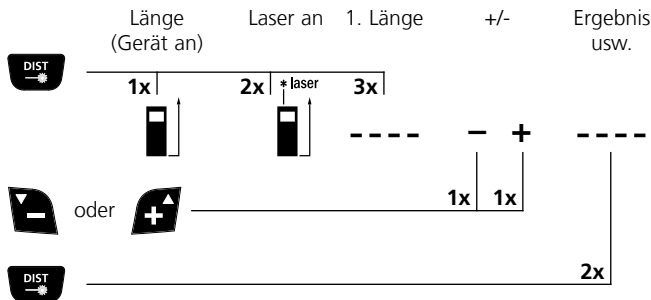

Weitere Längen werden durch Drücken der Taste DIST hinzugefügt.

## min/max-Dauermessung:

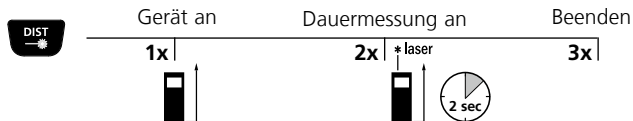

Das LC-Display zeigt den größten Wert (max), den kleinsten Wert (min), den Differenzwert und den aktuellen Wert an.

## Flächenmessung:

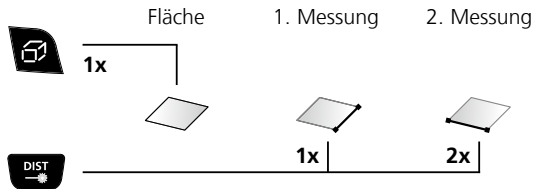

 Das LC-Display zeigt zusätzlichen den Raummfang an.

## Flächen Kalkulation:

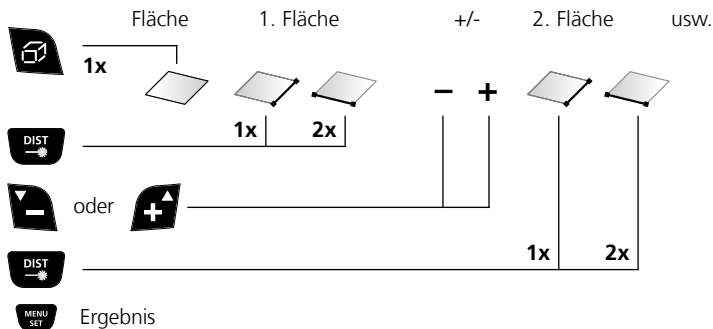

## Volumenmessung:

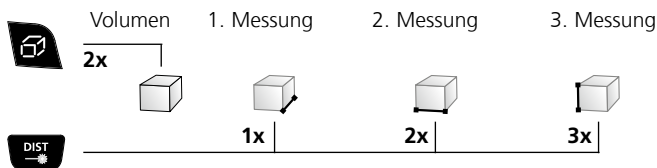

## Volumen Kalkulation:

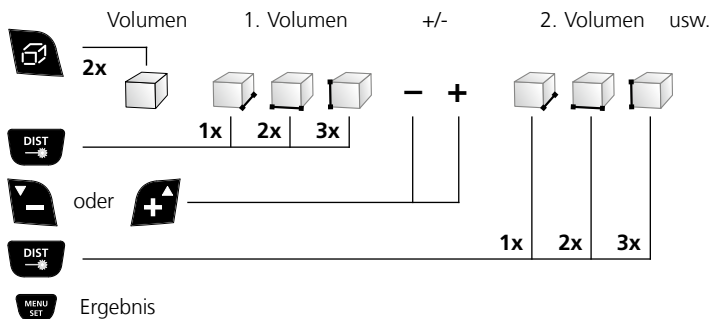

## Addition von Flächen / Wandflächenfunktion:

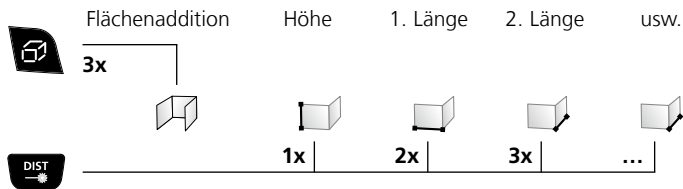

## Winkelfunktion:

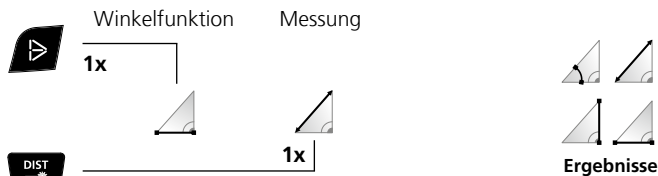

Die Messergebnisse werden durch den 360° Neigungssensor automatisch ermittelt.

**!** Die Rückseite des Gerätes dient als Bezugsfläche für die Messung von Winkeln.

## Pythagoras-Funktion 1:

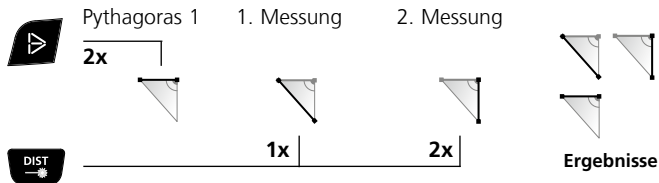

## Pythagoras-Funktion 2:

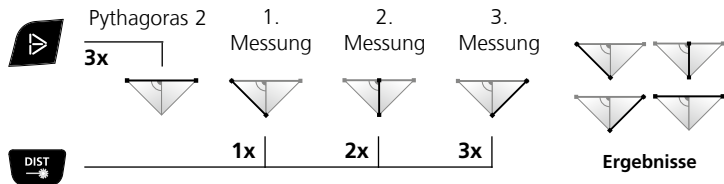

## Pythagoras-Funktion 3:

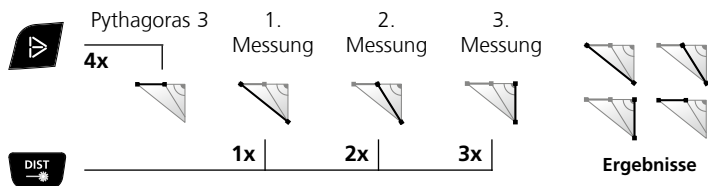

## Absteckfunktion:

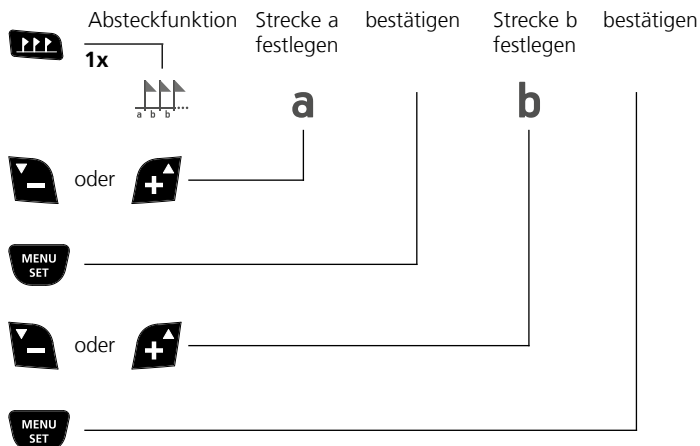



## Digitale Libelle:

Die digitale Libelle dient zur Ausrichtung von Gegenständen.



## Speicher-Funktion:

Das Gerät verfügt über 50 Speicherplätze.



## Wichtige Hinweise

- Der Laser zeigt den Messpunkt an, bis zu dem gemessen wird. In den Laserstrahl dürfen keine Gegenstände hineinragen.
- Das Gerät kompensiert bei der Messung unterschiedliche Raumtemperaturen. Berücksichtigen Sie daher eine kurze Anpassungszeit bei Ortswechseln mit großen Temperaturunterschieden.
- Das Gerät ist im Außenbereich nur eingeschränkt einsetzbar und kann bei starker Sonneneinstrahlung nicht verwendet werden.
- Bei Messungen im Freien können Regen, Nebel und Schnee die Messergebnisse beeinflussen bzw. verfälschen.
- Bei ungünstigen Bedingungen wie z.B. schlecht reflektierende Oberflächen kann die max. Abweichung größer als 3 mm betragen.
- Teppiche, Polster oder Vorhänge reflektieren den Laser nicht optimal. Benutzen Sie glatte Oberflächen.
- Bei Messungen durch Glas (Fensterscheiben) können die Messergebnisse verfälscht werden.
- Eine Energiesparfunktion schaltet das Gerät automatisch ab.
- Reinigung mit einem weichen Tuch. Es darf kein Wasser in das Gehäuse eindringen.

## Fehlercode:

- Err 1: Empfangenes Signal zu schwach
- Err 2: Empfangenes Signal zu stark
- Err 3: Batterien austauschen
- Err 4: Fehler im Speicher

- Err 5: Fehler in der Berechnung mit Pythagoras-Satz
- Err 6: Außerhalb des Messbereichs
- Err 7: Fehler in der Kamera
- Err 8: Fehler im Neigungssensor



## Technische Daten (Technische Änderungen vorbehalten. 18W19)

### Distanzmessung

Genauigkeit (typisch)*	$\pm 2$ mm
Messbereich (innen)**	0,05 m - 80 m

### Winkelmessung

Messbereich	$\pm 90^\circ$
-------------	----------------

Laserklasse	2 < 1 mW
-------------	----------

Laserwellenlänge	635 nm
------------------	--------

Arbeitsbedingungen	-0°C...40°C, Luftfeuchtigkeit max. 20...85%rH, nicht kondensierend, Arbeitshöhe max. 2000 m über NN (Normalnull)
--------------------	--

Lagerbedingungen	-20°C...60°C, Luftfeuchtigkeit max. 80%rH
------------------	---

Automatische Abschaltung	einstellbar
--------------------------	-------------

Stromversorgung	3 x Nickel-Metallhydrid (NiMH) Batterien (Akkus), Typ AAA 1,2V
-----------------	---

Abmessungen (B x H x T)	58 x 135 x 30 mm
-------------------------	------------------

Gewicht (inkl. Batterien)	210 g
---------------------------	-------

\* bis 10 m Messabstand bei gut reflektierender Zieloberfläche und Raumtemperatur. Bei größeren Distanzen und ungünstigen Messbedingungen, wie z.B. starke Sonneneinstrahlung oder schwach reflektierende Zieloberflächen, kann die Messabweichung um  $\pm 0,2$  mm/m steigen.

\*\* bei max. 10.000 lux

## EU-Bestimmungen und Entsorgung

Das Gerät erfüllt alle erforderlichen Normen für den freien Warenverkehr innerhalb der EU.

Dieses Produkt ist ein Elektrogerät und muss nach der europäischen Richtlinie für Elektro- und Elektronik-Altgeräte getrennt gesammelt und entsorgt werden.

Weitere Sicherheits- und Zusatzhinweise unter:

<http://laserliner.com/info?an=dimavi>

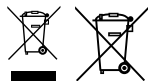

**!** Completely read through the operating instructions, the „Warranty and Additional Information“ booklet as well as the latest information under the internet link at the end of these instructions. Follow the instructions they contain. This document must be kept in a safe place and if the laser device is passed on, this document must be passed on with it.

## Function / Application

Laser distance meter with camera function

- For measuring length, area and volume
- Min/Max continuous measurement, wall surface function, angle function, Pythagoras 1 + 2 + 3, addition and subtraction function, digital bubble level, stake out function and 360° inclination sensor
- Camera function with 8x digital zoom and viewfinder to target the measurement area

## General safety instructions

- The device must only be used in accordance with its intended purpose and within the scope of the specifications.
- The measuring tools and accessories are not toys. Keep out of reach of children.
- Modifications or changes to the device are not permitted, this will otherwise invalidate the approval and safety specifications.
- Do not expose the device to mechanical stress, extreme temperatures, moisture or significant vibration.
- The device must no longer be used if one or more of its functions fail or the battery charge is weak.
- This device is designed for charging 1.2V AAA rechargeable nickel metal hydride (NiMH) batteries.
- On no account attempt to charge any other batteries as this could irreparably damage the device or cause serious injuries.
- Only charge rechargeable batteries of the same size, of the same type, same capacity and from the same manufacturer together.
- Please ensure compliance with the safety regulations set out by local and national authorities with regard to the correct and proper use of the device.

## Safety instructions

Using class 2 lasers



Laser radiation!  
Do not stare into the beam!  
Class 2 laser  
< 1 mW · 635 nm  
EN 60825-1:2014

- Attention: Do not look into the direct or reflected beam.
- Do not point the laser beam towards persons.
- If a person's eyes are exposed to class 2 laser radiation, they should shut their eyes and immediately move away from the beam.
- Tampering with (making changes to) the laser device is not permitted.
- Under no circumstances should optical instruments (magnifying glass, microscope, binoculars)

## Safety instructions

Dealing with electromagnetic radiation

- The measuring device complies with electromagnetic compatibility regulations and limit values in accordance with EMC-Directive 2014/30/EU.
- Local operating restrictions – for example, in hospitals, aircraft, petrol stations or in the vicinity of people with pacemakers – may apply. Electronic devices can potentially cause hazards or interference or be subject to hazards or interference.
- The measuring accuracy may be affected when working close to high voltages or high electromagnetic alternating fields.

## Inserting rechargeable batteries

Open the battery compartment and insert the rechargeable batteries (3x NiMH, type AAA) as indicated by the installation symbols.

Be sure to pay attention to polarity.

The rechargeable batteries can be charged in the device with the supplied USB charging cable.

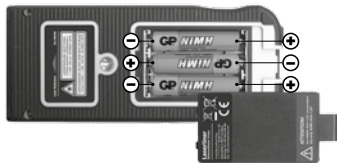

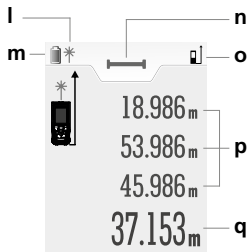
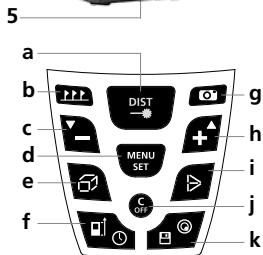

- 1 Laser reception field
- 2 Display
- 3 Connection socket for USB charger
- 4 Battery compartment (backside)
- 5 Hinged pin
- 6 Laser outlet
- 7 Camera

## KEYPAD:

- a ON / laser on / measure / min/max continuous measurement
- b Stake out function
- c Subtraction function / Decrease value / view saved measurements
- d Settings menu / Confirm
- e Length / area / volume / wall surface function
- f Timer function / Measurement point (reference) front / thread / rear / pin
- g Camera function
- h Addition function / Increase value / view saved measurements
- i Angle function / Pythagoras 1 + 2 + 3
- j OFF / delete last measurement values
- k Memory / Digital bubble level





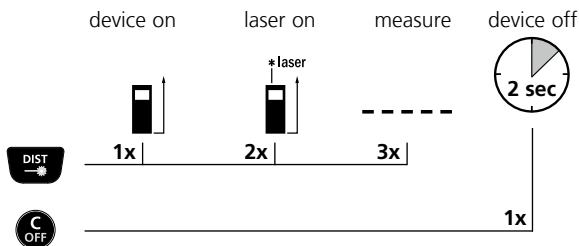

## DISPLAY:

- l Laser active
- m Battery symbol
- n Set measuring function
- o Measurement point (reference) front / thread / rear / pin
- p Intermediate values / min/max values
- q Measurement values / Measurement results

## Switch on, measure and switch off:



## Settings menu:

	<b>20</b> sec	Time setting to automatically power down the display lighting
	<b>060</b> sec	Time setting to automatically power down the laser
	<b>150</b> sec	Time setting to automatically power down the device
	<b>on</b>	Signal tone ON/OFF
	<b>0.000</b> m	Change unit of measure: m / ft / ' " / inch
	<b>°</b>	Change unit of measure: ° / %



Select setting option



Confirm selection (green indicator)



Change value



Confirm setting (red indicator)



Save setting (optional)



Exit menu

## Delete the last measured value:



## Change measurement point (reference):

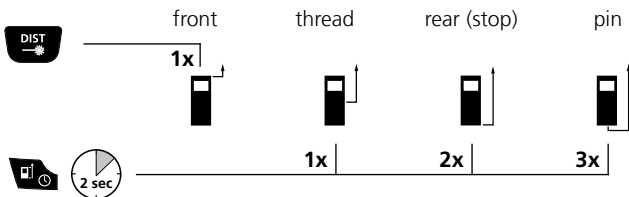

The device starts up with the last setting.

## Measuring plane, pin/stop:

For measurements out of a corner, fold down the pin and select the „measurement plane PIN“ setting.



For stop measurements move the pin to the side and select the „measurement plane REAR“ setting.



## Length measurement:

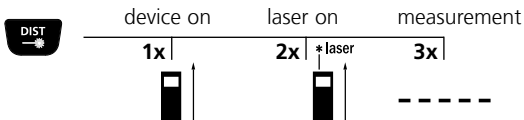

## Addition and subtraction of lengths:

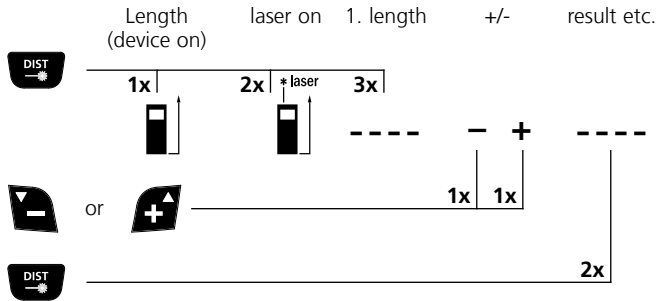

Further lengths are added by pressing the DIST button.

## min/max continuous measurement:

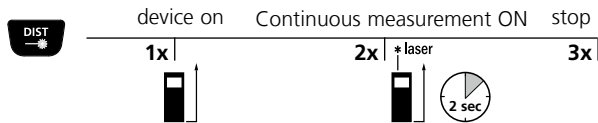

The LC display shows the max value, the min value, the differential value and the current value.

## Area measurement:

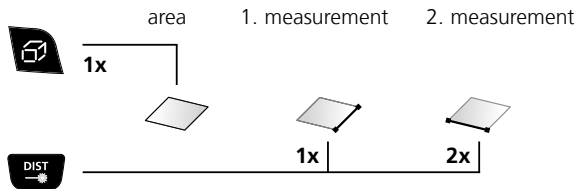

The room perimeter is additionally shown on the LC display.

## Area calculation:

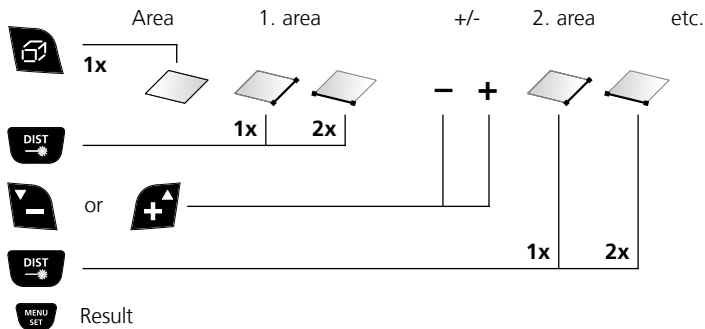

## Volume measurement:

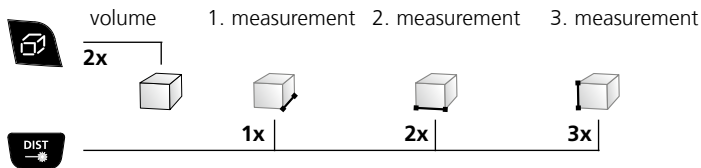

## Volume calculation:

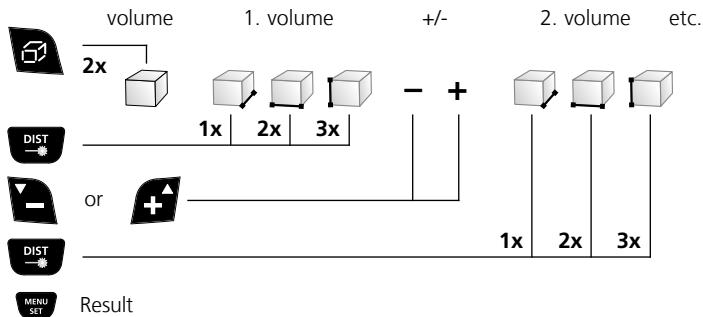



## Area addition / wall surface function:

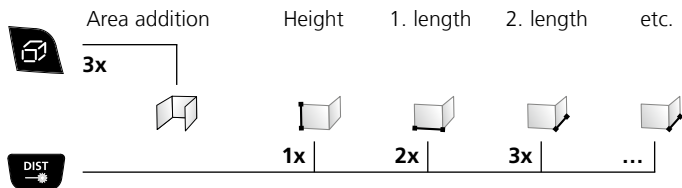

## Angle function:

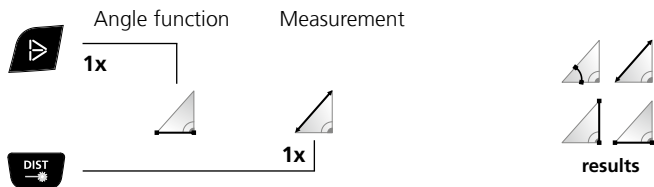

The measurement results are determined automatically by the 360° inclination sensor.

**!** The back of the device can be used as a reference surface for measuring angles.

## Pythagoras function 1:

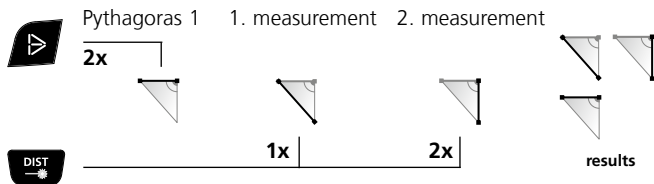

## Pythagoras function 2:

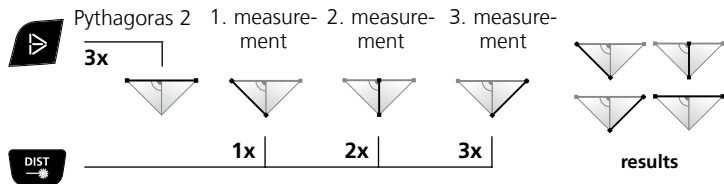

## Pythagoras function 3:

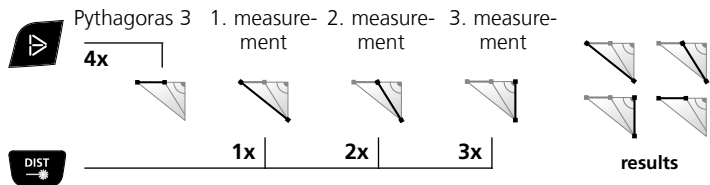

## Stake out function:

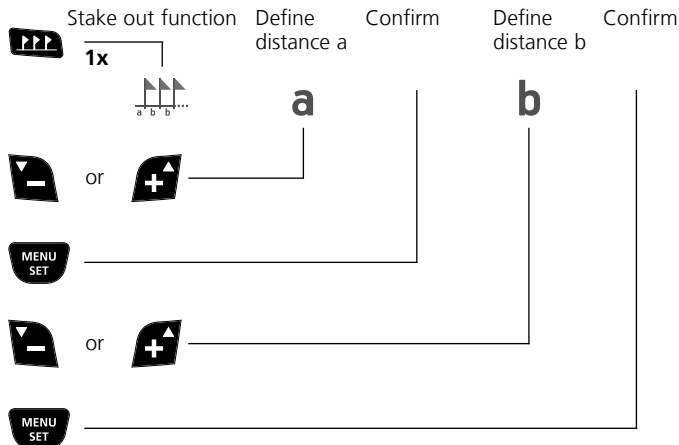



## Digital bubble level:

The digital bubble level is used to align objects.



## Memory function:

The device has 50 storage locations.



## Important notices

- The laser points to the location that will be measured. No objects may get into the laser's line of measurement.
- The device compensates the measurement for different room temperatures. Therefore allow the device a brief adaptation period when changing locations with large temperature differences.
- The device is only conditionally useable in outdoor areas and cannot be used in strong sunlight.
- The measurement results of outdoor measurements may be influenced or falsified by rain, fog and snow.
- In unfavourable conditions, e.g. with poorly reflecting surfaces, the maximum deviation may be greater than 3 mm.
- Carpeting, upholstery or curtains will not reflect the laser optimally. Measure to flat surfaces.
- Measurements made through glass (window panes) can falsify measurement results.
- An energy-saving function switches the device off automatically.
- Clean with a soft cloth. Water may not be allowed to penetrate the housing.

## Error code:

- Err 1: Received signal too weak
- Err 2: Received signal too strong
- Err 3: Replace the battery
- Err 4: Error in memory

- Err 5: Error in calculation with Pythagoras' theorem
- Err 6: Outside the measuring range
- Err 7: Error in camera
- Err 8: Error in inclination sensor

## Technical Data (Subject to technical changes without notice. 18W19)

### Distance measurement

Precision (typical)*	$\pm 2$ mm
Measurement range (inside)**	0.05 m - 80 m

### Angle measurement

Measuring range	$\pm 90^\circ$
-----------------	----------------

Laser class	2 < 1 mW
-------------	----------

Laser wavelength	635 nm
------------------	--------

Operating conditions	-0°C...40°C, Max. humidity 20...85% rH, no condensation, Max. working altitude 2000 m above sea level
----------------------	---

Storage conditions	-20°C...60°C, Max. humidity 80% rH
--------------------	------------------------------------

Automatic switch-off	adjustable
----------------------	------------

Power supply	3x nickel metal hydride (NiMH) rechargeable battery, type AAA 1,2V
--------------	--

Dimensions (W x H x D)	58 x 135 x 30 mm
------------------------	------------------

Weight (incl. batteries)	210 g
--------------------------	-------

\* measuring distance up to 10 m with strongly reflective target surface and at room temperature. The measurement deviation may increase by  $\pm 0.2$  mm/m for greater distances and under unfavourable measuring conditions such as strong sunlight or weakly reflective target surfaces.

\*\* at max. 10,000 lux

## EU directives and disposal

This device complies with all necessary standards for the free movement of goods within the EU.

This product is an electric device and must be collected separately for disposal according to the European Directive on waste electrical and electronic equipment.

Further safety and supplementary notices at:  
<http://laserliner.com/info?an=dimavi>

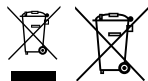

**!** Lees de handleiding, de bijgevoegde brochure 'Garantie- en aanvullende aanwijzingen' evenals de actuele informatie en aanwijzingen in de internet-link aan het einde van deze handleiding volledig door. Volg de daarin beschreven aanwijzingen op. Bewaar deze documentatie en geef ze door als u de laserinrichting doorgeeft.

### Functie / toepassing

Laser-afstandsmeter met camerafunctie

- Voor het meten van lengten, oppervlakken en volumes
- Constante min / max-meting, wandoppervlaktefunctie, hoekfunctie, Pythagoras 1 + 2 + 3, optel- en aftrekfunctie, digitale libel, afsteekfunctie en 360°-neigingssensor
- Camerafunctie met 8-voudige digitaalzoom en viewfinder voor het peilen van het meetbereik

### Algemene veiligheidsaanwijzingen

- Gebruik het apparaat uitsluitend doelmatig binnen de aangegeven specificaties.
- De meetapparaten en het toebehoren zijn geen kinderspeelgoed. Buiten het bereik van kinderen bewaren.
- Ombouwwerkzaamheden of veranderingen aan het apparaat zijn niet toegestaan, hierdoor komen de goedkeuring en de veiligheidsspecificatie te vervallen.
- Stel het apparaat niet bloot aan mechanische belasting, extreme temperaturen, vocht of sterke trillingen.
- Het apparaat mag niet meer worden gebruikt als een of meerdere functies uitvallen of de batterijlading zwak is.
- Het apparaat is alleen bedoeld voor het opladen van nikkel-metaalhydride (NiMH) batterijen (accu's), type AAA 1,2V.
- Probeer in geen geval andere batterijen op te laden omdat het toestel hierdoor onherstelbaar kan worden beschadigd of mensen gevaarlijk gewond kunnen raken.
- Laad alleen oplaadbare batterijen (accu's) van dezelfde grootte, hetzelfde type, dezelfde capaciteiten en van dezelfde fabrikant samen op.
- Neem de veiligheidsvoorschriften van lokale resp. nationale instanties voor het veilige en deskundige gebruik van het apparaat in acht.

## Veiligheidsinstructies

Omgang met lasers van klasse 2



Laserstraling!  
Niet in de straal kijken!  
Laser klasse 2  
< 1 mW · 635 nm  
EN 60825-1:2014

- Opgelet: Kijk nooit in de directe of reflecterende straal.
- Richt de laserstraal niet op personen.
- Als laserstraling volgens klasse 2 de ogen raakt, dient u deze bewust te sluiten en uw hoofd zo snel mogelijk uit de straal te bewegen.
- Manipulaties (wijzigingen) aan de laserinrichting zijn niet toegestaan.
- Bekijk de laserstraal of de reflecties nooit met behulp van optische apparaten (loep, microscoop, verrekijker, ...).

## Veiligheidsinstructies

Omgang met elektromagnetische straling

- Het meettoestel voldoet aan de voorschriften en grenswaarden voor de elektromagnetische compatibiliteit volgens de EMC-richtlijn 2014/30/EU.
- Plaatselijke gebruiksbeperkingen, bijv. in ziekenhuizen, in vliegtuigen, op pompstations of in de buurt van personen met een pacemaker, moeten in acht worden genomen. Een gevaarlijk effect op of storing van en door elektronische apparaten is mogelijk.
- Bij de toepassing in de buurt van hoge spanningen of hoge elektromagnetische wisselvelden kan de meetnauwkeurigheid negatief worden beïnvloed.

## Oplaadbare batterijen plaatsen

Open het batterijvakje en plaats , de oplaadbare batterijen (3 x NiMH, type AAA) overeenkomstig de installatie-symbolen. Let daarbij op de juiste polariteit.

De oplaadbare batterijen kunnen met de bijgeleverde usb-laadkabel in het toestel worden geladen.

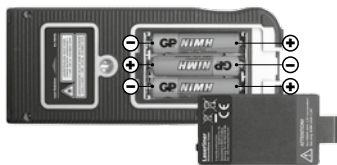



1 6 7

2

3

4

5

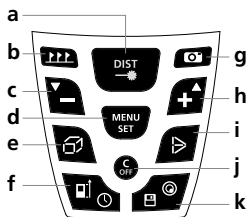

a

b

c

d

e

f

g

h

i

j

k

l

m

n

o

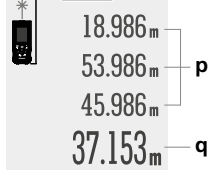

p

q

- 1 Laserontvangstveld
- 2 Display
- 3 Aansluitbus voor USB laadtoestel
- 4 Batterijvakje (achterkant)
- 5 Uitklapbare pin
- 6 Laseruitlaat
- 7 Camera

## TOETSENBORD:

- a AAN / laser aan / meten / Constante min/max-meting
- b Afsteekfunctie
- c Aftrekfunctie / Waarde verminderen / opgeslagen meetwaarden bekijken
- d Instelmenu / Bevestigen
- e Lengte / oppervlak / volume / wandoppervlak-functie
- f Timerfunctie / Meetniveau (referentie) voor / schroefdraad / achter / pin
- g Camerafunctie
- h Optelfunctie / Waarde verhogen / opgeslagen meetwaarden bekijken
- i Hoekfunctie / Pythagoras 1 + 2 + 3
- j UIT / Wissen van de laatste meetwaarden
- k Geheugen / Digitale libel

## DISPLAY:





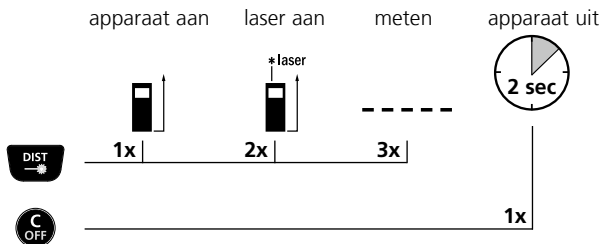

- l Laser actief
- m Batterijsymbool
- n Ingestelde meetfunctie
- o Meetniveau (referentie) voor / schroefdraad / achter / pin
- p Tussenwaarden / min-/max-waarde
- q Meetwaarden / meetresultaten eenheid







## Inschakelen, meten en uitschakelen:



## Instelmenu:

	<b>20</b> sec	Tijdstelling automatische uitschakeling van de displayverlichting
	<b>060</b> sec	Tijdstelling automatische uitschakeling van de laser
	<b>150</b> sec	Tijdstelling automatische uitschakeling van het toestel
	<b>on</b>	Signaalgeluid in-/uitschakelen
	<b>0.000</b> m	Meeteenheid omschakelen: m / ft / ' " / inch
	<b>°</b>	Meeteenheid omschakelen: ° / %

- MENU SET**
-  Insteloptie selecteren
  -  Selectie bevestigen (groene kenmerking)
  -  Waarde veranderen
  -  Instelling bevestigen (rode kenmerking)
  -  Instellingen opslaan (optie)
  -  Menu verlaten

## Wissen van de laatste meetwaarde:



## Skift af måleplan (reference):

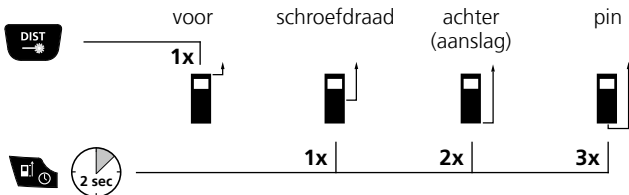

Het toestel start met de laatste instelling.

## Meetniveau pin / aanslag:

Klap de pin voor metingen vanuit de hoek naar beneden en selecteer de instelling 'Meetniveau PIN'.



Klap de pin voor aanslagmetingen naar opzij en selecteer de instelling 'Meetniveau achter' selecteren.



## Lengtemeting:

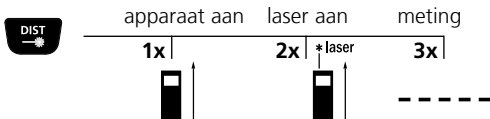

## Optellen en aftrekken van lengten:

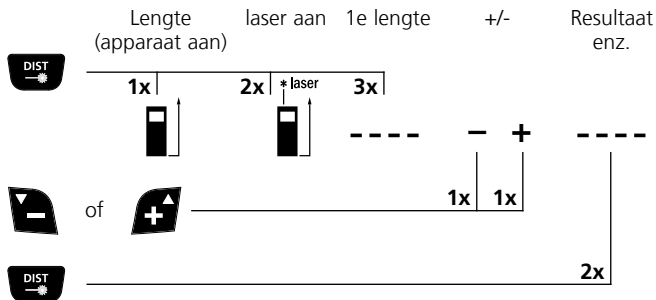

Druk op de toets DIST om andere lengten toe te voegen.

## Constance min/max-meting:

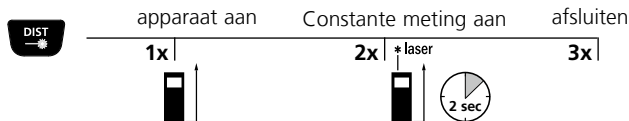

Het LC-display geeft de grootste waarde (max.), de kleinste waarde (min.), de verschilwaarde en de actuele waarde aan.

## Oppervlaktemeting:

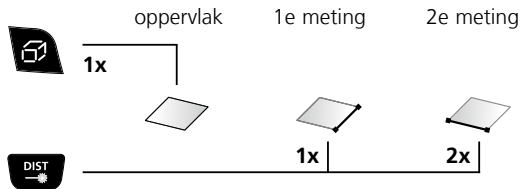

Het LC-display laat bovendien de vertrekomvang zien.

## Oppervlakteberekening:

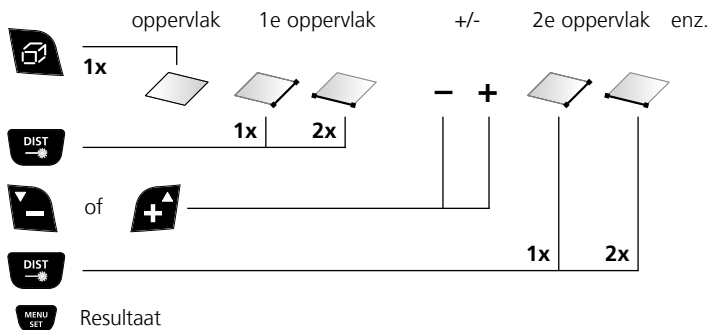

## Volumemeting:

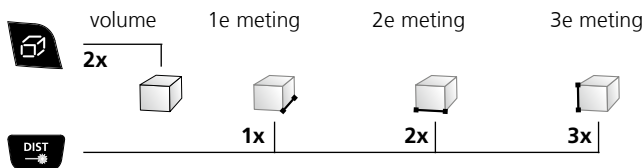

## Volumeberekening:

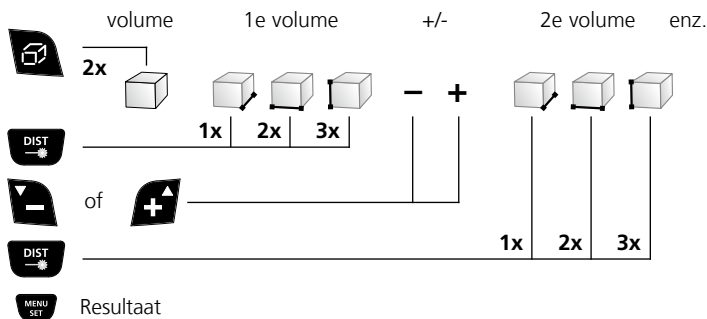

## Optellen van oppervlakken / wandoppervlak-functie:

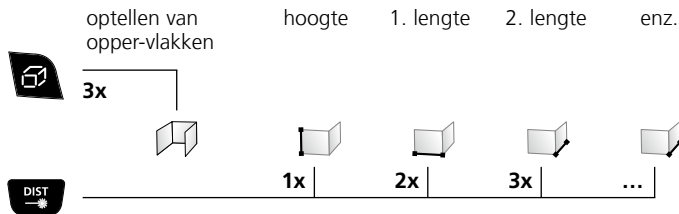

## Hoekfunctie:

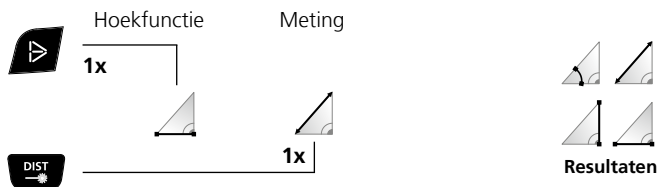

De meetresultaten worden automatisch bepaald door de 360°-neigingsensor.

**!** De achterzijde van het apparaat is bedoeld als referentievlak voor de meting van hoeken.

## Pythagorasfunctie 1:

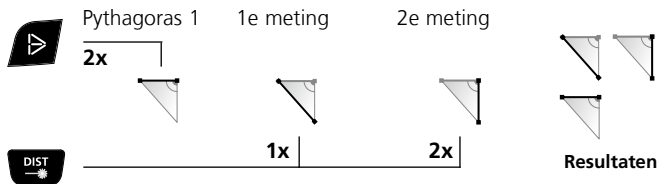

## Pythagorasfunctie 2:

 Pythagoras 2  
**3x**

1e meting      2e meting      3e meting

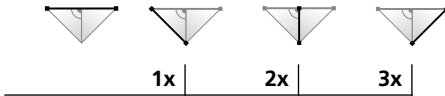

**1x**      **2x**      **3x**



Resultaten

## Pythagorasfunctie 3:

 Pythagoras 3  
**4x**

1e meting      2e meting      3e meting

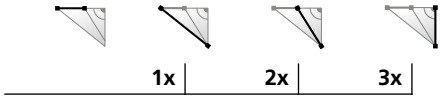

**1x**      **2x**      **3x**





Resultaten

## Afsteekfunctie:

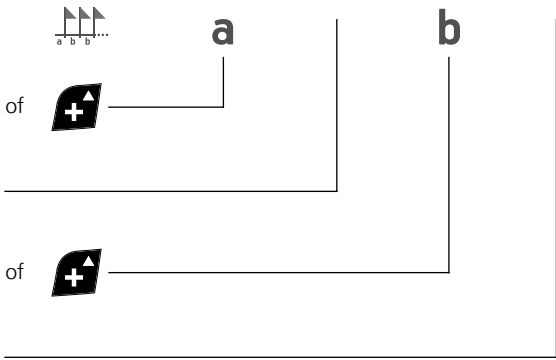

 Afsteekfunctie      afstand a vastleggen      bevestigen      afstand b vastleggen      bevestigen

**1x**



of 



of 





Beweeg het toestel in de pijlrichting om het doel te bereiken



Doel bereikt



Beweeg het toestel in de pijlrichting om het doel te bereiken

## Timerfunctie:

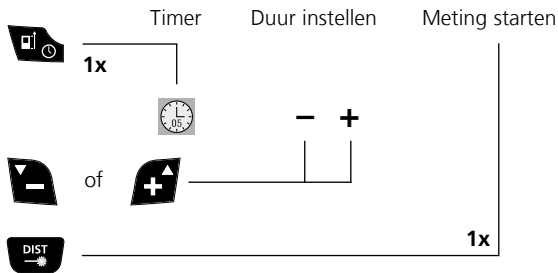

## Camerafunctie:

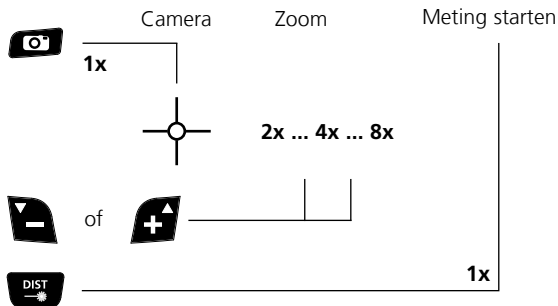

## Digitale libel:

De digitale libel is bedoeld voor de uitlijning van voorwerpen.



## Geheugenfunctie:

Het toestel beschikt over 50 geheugenplaatsen.



## Belangrijke opmerkingen

- De laser geeft het meetpunt aan tot waar gemeten wordt. De laserstraal mag niet door voorwerpen onderbroken worden.
- Bij de meting compenseert het apparaat verschillende ruimtetemperaturen. Houd daarom rekening met een korte aanpassingstijd bij plaatsveranderingen met grote temperatuurverschillen.
- Het apparaat kan in het buitenbereik slechts beperkt worden toegepast en kan bij sterke zoninstraling niet worden gebruikt.
- Bij metingen in de openlucht kunnen regen, mist en sneeuw de meetresultaten beïnvloeden resp. vervalsen.
- Bij ongunstige omstandigheden zoals bijv. slecht reflecterende oppervlakken kan de maximale afwijking meer dan 3 mm bedragen.
- Tapijten, kussens of gordijnen reflecteren de laser niet optimaal. Werk dus met gladde oppervlakken.
- Bij metingen door glas (ramen) kunnen de meetresultaten worden vervalst.
- Een energiebesparingsfunctie schakelt het apparaat automatisch uit.
- Reinig het apparaat met een zachte, droge doek. Er mag geen water in de behuizing dringen.

## Foutcode:

- Err 1: Ontvangen signaal te zwak
- Err 2: Ontvangen signaal te sterk
- Err 3: Batterij is bijna leeg
- Err 4: Fout in het geheugen

- Err 5: Fout in de berekening met de stelling van Pythagoras
- Err 6: Buiten het meetbereik
- Err 7: Fout in de camera
- Err 8: Fout in de neigingsensor



## Technische gegevens (Technische veranderingen voorbehouden. 18W19)

### Afstandsmeting

Nauwkeurigheid (karakteristiek)*	$\pm 2$ mm
Meetbereik (binnen)**	0,05 m - 80 m

### Hoekmeting

Meetbereik	$\pm 90^\circ$
------------	----------------

Laserklasse	2 < 1 mW
-------------	----------

Lasergolflengte	635 nm
-----------------	--------

Werkomstandigheden	-0°C...40°C, Luchtvochtigheid max. 20...85% rH, niet-condenserend, Werkhoogte max. 2000 m boven NAP (Nieuw Amsterdams Peil)
--------------------	---

Opslagvoorwaarden	-20°C...60°C, Luchtvochtigheid max. 80% rH
-------------------	--

Automatische uitschakeling	instelbaar
----------------------------	------------

Stroomvoorzorging	3 x nikkel-metaalhydride (NiMH) batterijen (accu's), typ AAA 1,2V
-------------------	---

Afmetingen (B x H x D)	58 x 135 x 30 mm
------------------------	------------------

Gewicht (incl. batterijen)	210 g
----------------------------	-------

\* tot 10 m meetafstand bij goed reflecterend doeloppervlak en bij ruimtetemperatuur. Bij grotere afstanden en ongunstige meetvoorwaarden, zoals sterke zonnestraling of zwak reflecterende doeloppervlakken, kan de meetafwijking  $\pm 0,2$  mm/m groter worden.

\*\* bij max. 10.000 lux

## EU-bepalingen en afvoer

Het apparaat voldoet aan alle van toepassing zijnde normen voor het vrije goederenverkeer binnen de EU.

Dit product is een elektrisch apparaat en moet volgens de Europese richtlijn voor oude elektrische en elektronische apparatuur gescheiden verzameld en afgevoerd worden.

Verdere veiligheids- en aanvullende instructies onder:

<http://laserliner.com/info?an=dimavi>





Du bedes venligst læse betjeningsvejledningen, det vedlagte hæfte „Garanti- og supplerende anvisninger“ samt de aktuelle oplysninger og henvisninger på internet-linket i slutning af denne vejledning fuldstændigt igennem. Følg de heri indeholdte instrukser. Dette dokument skal opbevares og følge med laserenheden, hvis denne overdrages til en ny bruger.

### Funktion / anvendelse

Laser-afstandsmåler med kamerafunktion

- Måling af længder, flader og volumen
- Min/max-måling, vægfladefunktion, vinkelfunktion, pythagoras  $1 + 2 + 3$ , additions- og subtraktionsfunktion, digital libelle, afstigningsfunktion og  $360^\circ$  hældningssensor
- Kamerafunktion med 8x digital zoom og viewfinder til sigtning på måleområdet

### Almindelige sikkerhedshenvisninger

- Apparatet må kun bruges til det tiltænkte anvendelsesformål inden for de givne specifikationer.
- Måleapparaterne og tilbehøret er ikke legetøj. Skal opbevares utilgængeligt for børn.
- Ombygning eller ændring af apparatet er ikke tilladt og vil medføre, at godkendelsen og sikkerhedsspecifikationerne bortfalder.
- Undgå at udsætte apparatet for mekaniske belastninger, meget høje temperaturer, fugt eller kraftige vibrationer.
- Apparatet må ikke anvendes længere, hvis en eller flere funktioner svigter, eller hvis batteriladningen er svag.
- Dette apparat er kun konstrueret til opladning af genopladelige nikkel-metalhydrid (NiMH) batterier (akkuer), type AAA 1,2V.
- Forsøg under ingen omstændigheder at oplade andre batterier, da dette kan ødelægge apparatet eller forårsage farlige skader på mennesker.
- Forsøg under ingen omstændigheder at oplade andre batterier, da dette kan ødelægge apparatet eller forårsage farlige skader på mennesker.
- Iagttag sikkerhedsforanstaltningerne fra lokale og/eller nationale myndigheder med henblik på saglig korrekt brug af apparatet.

## Sikkerhedsanvisninger

Omgang med lasere i klasse 2



Laserstråling!  
Se ikke ind i strålen!  
Laser klasse 2  
< 1 mW · 635 nm  
EN 60825-1:2014

- Pas på: Undgå at se ind i en direkte eller reflekterende stråle.
- Undgå at rette laserstrålen mod personer.
- Hvis laserstråling i klasse 2 rammer en person i øjnene, skal vedkommende bevidst lukke øjnene og straks fjerne hovedet fra strålen.
- Manipulation (ændring) af laserenheden er ikke tilladt.
- Laserstrålen eller dens refleksioner må aldrig betragtes gennem optisk udstyr (lup, mikroskop, kikkert, ...).

## Sikkerhedsanvisninger

Omgang med elektromagnetisk stråling

- Måleapparatet overholder forskrifterne og grænseværdierne for elektromagnetisk kompatibilitet iht. EMC-direktiv 2014/30/EU.
- Lokale anvendelsesrestriktioner, f.eks. på hospitaler, i fly eller i nærheden af personer med pacemaker, skal iagttages. Risikoen for farlig påvirkning eller fejl i eller pga. elektronisk udstyr er til stede.
- Ved anvendelse i nærheden af høje spændinger eller under høje elektromagnetiske vekselfelter kan måleapparatets nøjagtighed blive påvirket.

## Ilægning af nye genopladelige batterier

Åbn batterirummet og læg genopladelige batterier (3 x NiMH, type AAA) i iht. installationssymbolerne. Vær opmærksom på de angivne poler.

De genopladelige batterier kan oplades i apparatet med det vedlagte USB-ladekabel.

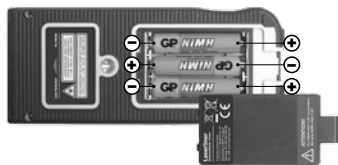

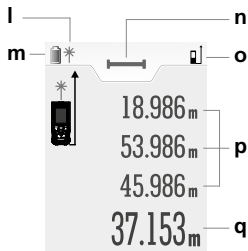
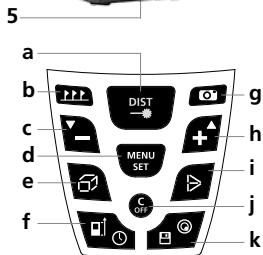

- 1 Lasermodtagelsesfelt
- 2 Display
- 3 Tilslutningsstik til USB oplader
- 4 Batterirum (bagside)
- 5 Klappbar pin
- 6 Laserudgang
- 7 Kamera

## TASTATUR:

- a TÆND / Laser tændt / Måling / min/max-kontinuerlig måling
- b Afstikningsfunktion
- c Subtraktionsfunktion / Reducering af værdi / vis gemte måleværdier
- d Indstillingsmenu / Bekræft
- e Længde / Flade / Rumfang / Vægfladefunktion
- f Timer-funktion / Måleplan (reference) foran / gevind / bag / pind
- g Kamerafunktion
- h Additionsfunktion / Forøgelse af værdi / vis gemte måleværdier
- i Vinkelfunktion / Pythagoras 1 + 2 + 3
- j SLUK / Sletning af sidste måleværdier
- k Hukommelse / digital libelle





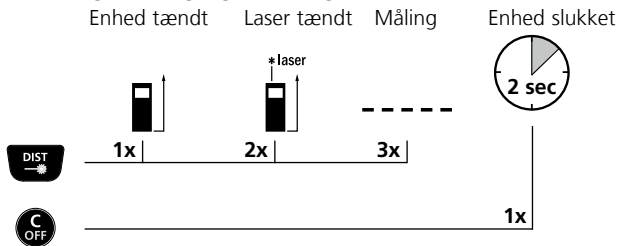

## DISPLAY:

- l Laser aktiv
- m Batterisymbol
- n Indstillet målefunktion
- o Måleplan (reference) foran / gevind / bag / pind
- p Mellemværdier / min/max-værdier
- q Måleværdier / Måleresultater

## Tænding, måling og slukning:



## Indstillingsmenu:

	<b>20</b> sec	Tidsindstilling automatisk slukning af display-belysning
	<b>060</b> sec	Tidsindstilling automatisk slukning af laser
	<b>150</b> sec	Tidsindstilling automatisk slukning af apparat
	<b>on</b>	Signal tone til / fra
	<b>0.000</b> m	Skift af måleenhed: m / ft / ' " / inch
	<b>°</b>	Skift af måleenhed: ° / %



Valg af indstillingsoption



Bekræft valg (grøn mærkning)



Ændring af værdi



Bekræft indstilling (rød mærkning)



Arkivering af indstilling (tilvalg)



Afslut menu

## Sletning af den sidste måleværdi:



## Skift af måleplan (reference):

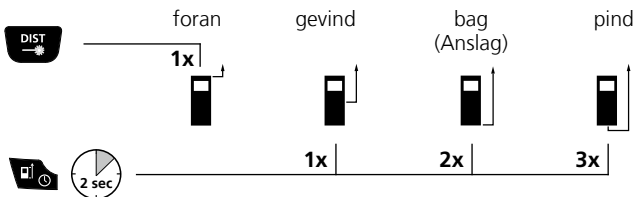

Apparatet starter med den sidste indstilling.

## Måleplan pin / anslag:

Ved målinger fra hjørnet, klap pinnen ned og vælg indstilling „måleplan PIN“.



Ved anslagsmålinger, klap pinnen til side og vælg indstilling „måleplan bag“.



## Længdemåling:

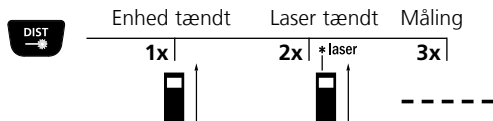

## Addition og subtraktion af længder:

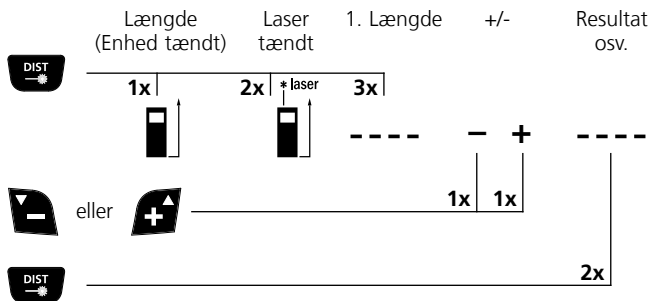

Yderligere længder tilføjes ved tryk på knap DIST.

## min/max-kontinuerlig måling:

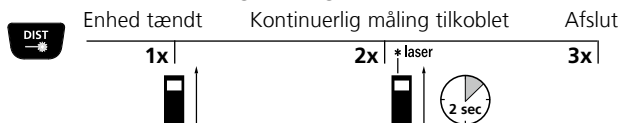

LC-displayet viser den største værdi (max), den mindste værdi (min), forskelsværdien og den aktuelle værdi.

## Flademåling:

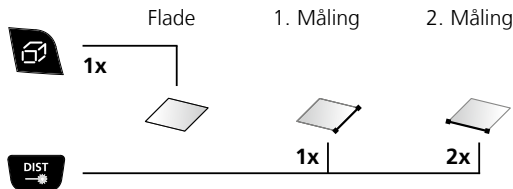

 LC-displayet vises også rumomfanget.

## Flade-beregning:

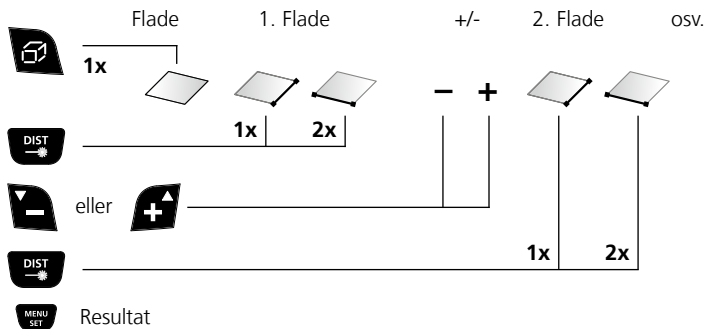

## Rumfangsmåling:

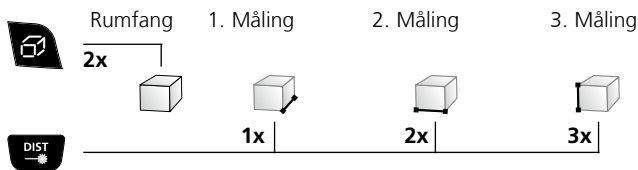

## Rumfangsberegning:

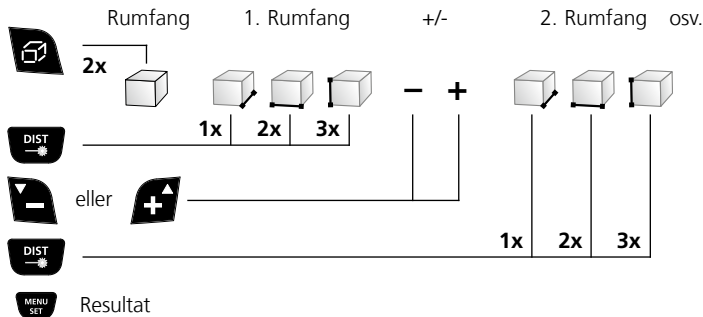



## Flade-addition / Vægfladefunktion:

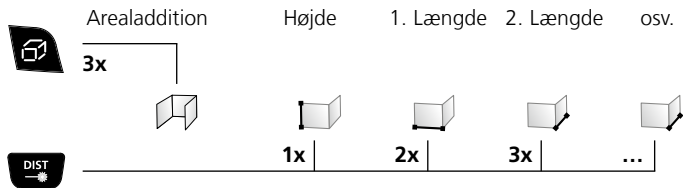

## Vinkelfunktion:

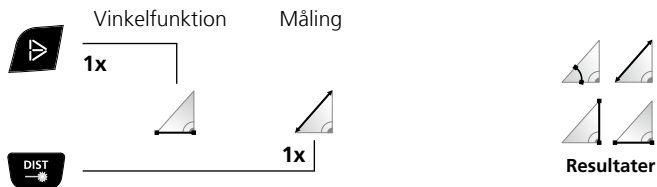

Måleresultaterne bestemmes automatisk via den 360° hældningssensor.

**!** Apparatets bagside fungerer som referenceflade for måling af vinkler.

## Pythagorasfunktion 1:

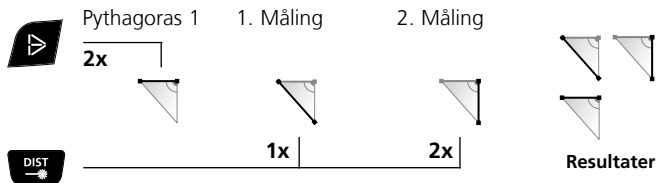

## Pythagorasfunktion 2:

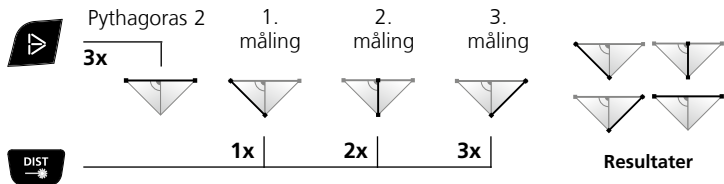

## Pythagorasfunktion 3:

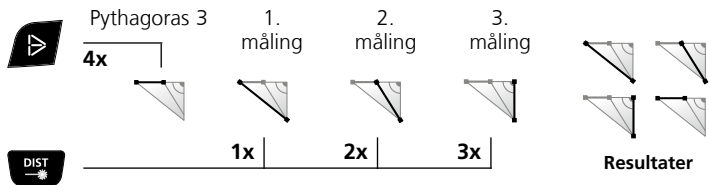

## Afstikningsfunktion:

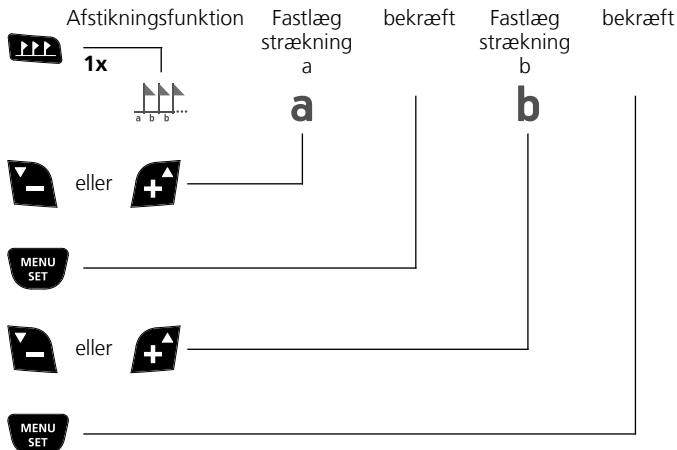



For at nå målet skal apparatet bevæges i pilens retning



Mål nået



For at nå målet skal apparatet bevæges i pilens retning

## Timer-funktion:

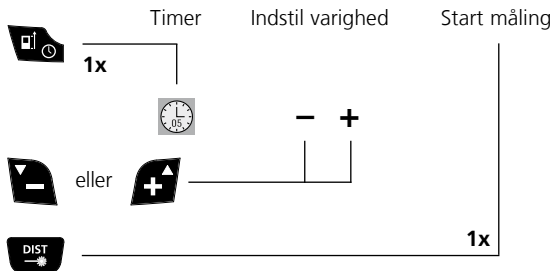

## Kamerafunktion:

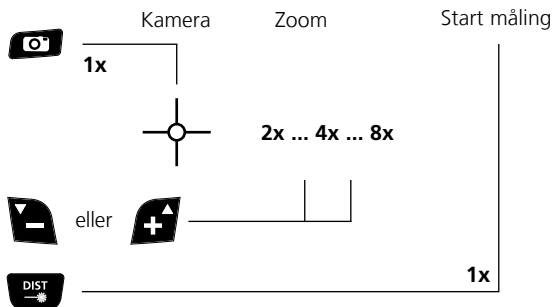

## Digital libelle:

Den digitale libelle bruges til justering af genstande.



## Hukommelsesfunktion:

Apparatet råder over 50 hukommelsespladser.



## Vigtigt

- Laseren angiver det målepunkt, hvortil der måles. Der må ikke komme genstande i vejen for laserstrålen.
- Enheden kompenserer for forskellige rumtemperaturer under målingen. Man skal derfor være opmærksom på, at der er en kort tilpasningstid, når der skiftes mellem steder med store temperaturforskelle.
- Enheden kan kun bruges i begrænset omfang udendørs og slet ikke i kraftigt sollys.
- Ved måling i det fri kan regn, tåge og sne påvirke og / eller forfalske måleresultaterne.
- Under ugunstige forhold som fx dårligt reflekterende overflader kan den maksimale afvigelse være større end 3 mm.
- Tæpper, puder eller gardiner reflekterer ikke laseren optimalt. Sørg for at bruge glatte overflader.
- Ved måling gennem glas (ruder) risikerer man, at måleresultatet bliver forfalsket.
- En energisparefunktion slukker automatisk for enheden.
- Rengøres med en blød klud. Der må ikke trænge vand ind i huset.

## Fejlkode:

- Err 1: Modtaget signal for svagt
- Err 2: Modtaget signal for kraftigt
- Err 3: Udskift batterier
- Err 4: Fejl i hukommelse

- Err 5: Fejl i beregning med pythagoras sætning
- Err 6: Uden for måleområdet
- Err 7: Fejl på kamera
- Err 8: Fejl på hældningssensor

## Tekniske data (Ret til ændringer forbeholdt. 18W19)

### Afstandsmåling

Nøjagtighed (typisk)*	± 2 mm
Måleområde (indendørs)**	0,05 m - 80 m

### Vinkelmåling

Måleområde	± 90°
------------	-------

Laserklasse	2 < 1 mW
-------------	----------

Laserbølgelængde	635 nm
------------------	--------

Arbejdsbetingelser	-0°C...40°C, Luftfugtighed maks. 20...85% rH, ikke-kondenserende, Arbejdshøjde maks. 2000 m.o.h.
--------------------	--

Opbevaringsbetingelser	-20°C...60°C, Luftfugtighed maks. 80% rH
------------------------	--

Automatisk slukning	indstillelig
---------------------	--------------

Strømforsyning	3 x nikkel-metalhydrid (NiMH) batterier (akkuer), type AAA 1,2V
----------------	---

Mål (B x H x D)	58 x 135 x 30 mm
-----------------	------------------

Vægt (inkl. batterier)	210 g
------------------------	-------

\* op til 10 m måleafstand ved godt reflekterende måloverflade og rumtemperatur. Ved større afstande og mindre gode måleforhold som fx kraftigt sollys eller svagt reflekterende måloverflader kan måleafvigelsen stige med ± 0,2 mm/m.

\*\* ved maks. 10.000 lux

## EU-bestemmelser og bortskaffelse

Apparatet opfylder alle påkrævede standarder for fri vareomsætning inden for EU.

Dette produkt er et elapparat og skal indsamles og bortskaffes separat i henhold til EF-direktivet for (brugte) elapparater.

Flere sikkerhedsanvisninger og supplerende tips på:

<http://laserliner.com/info?an=dimavi>

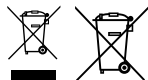

**!** Lisez entièrement le mode d'emploi, le carnet ci-joint « Remarques supplémentaires et concernant la garantie » et les renseignements et consignes présentés sur le lien Internet précisé à la fin de ces instructions. Suivez les instructions mentionnées ici. Conservez ces informations et les donner à la personne à laquelle vous remettez le dispositif laser.

### Fonction / Utilisation

Télémètre laser avec fonction caméra

- Mesure des distances, des surfaces et des volumes
- Mesure continue min./max., fonction pour surfaces murales, fonction d'angle, Pythagore 1 + 2 + 3, fonction d'addition et de soustraction, bulle numérique, fonction implantation et capteur d'inclinaison de 360°
- Fonction caméra avec zoom numérique octuple et Viewfinder pour viser la plage de mesure

### Consignes de sécurité générales

- Utiliser uniquement l'instrument pour l'emploi prévu dans le cadre des spécifications.
- Les appareils et les accessoires ne sont pas des jouets. Les ranger hors de portée des enfants.
- Les transformations ou modifications de l'appareil ne sont pas autorisées, et annuleraient l'homologation et les spécifications de sécurité.
- Ne pas soumettre l'appareil à une charge mécanique, ni à des températures extrêmes ni à de l'humidité ou à des vibrations importantes.
- Ne plus utiliser l'instrument lorsqu'une ou plusieurs fonction(s) ne fonctionne(nt) plus ou lorsque le niveau de charge de la pile est bas.
- Cet appareil n'a été conçu que pour charger les piles rechargeables (accus) nickel-métal hydrure (NiMH) du type AAA 1,2 V.
- Ne jamais essayer de charger d'autres piles car cela pourrait entraîner la destruction de l'appareil ou causer des blessures graves chez l'homme.
- Ne charger en même temps que des piles rechargeables (accus) de la même taille, du même type, de la même capacité et du même fabricant.
- Prière de tenir compte des mesures de sécurité de l'administration locale et/ou nationale relative à l'utilisation correcte de l'appareil.

## Consignes de sécurité

Utilisation des lasers de classe 2



Rayonnement laser!  
Ne pas regarder dans le faisceau.  
Appareil à laser de classe 2  
< 1 mW · 635 nm  
EN 60825-1:2014

- Attention : Ne pas regarder le rayon direct ou réfléchi.
- Ne pas diriger le rayon laser sur des personnes.
- Si le rayonnement laser de la classe 2 touche les yeux, fermez délibérément les yeux et tournez immédiatement la tête loin du rayon.
- Il est interdit de manipuler (modifier) le dispositif laser.
- Ne jamais regarder le faisceau laser ni les réflexions à l'aide d'instruments optiques (loupe, microscope, jumelles, etc.).

## Consignes de sécurité

Comportement à adopter lors de rayonnements électromagnétiques

- L'appareil de mesure respecte les prescriptions et les valeurs limites de compatibilité électromagnétique conformément à la directive CEM 2014/30/UE.
- Il faut tenir compte des restrictions des activités par ex. dans les hôpitaux, les avions, les stations-services ou à proximité de personnes portant un stimulateur cardiaque. Les appareils électroniques peuvent être la source ou faire l'objet de risques ou de perturbations.
- L'utilisation de l'instrument de mesure à proximité de tensions élevées ou dans des champs alternatifs électromagnétiques forts peut avoir une influence sur la précision de la mesure.

## Mise en place des piles rechargeables

Ouvrir le compartiment à piles et insérer les piles rechargeables (3 NiMH du type AAA) en respectant les symboles de pose. Veiller à ce que la polarité soit correcte.

Il est possible de recharger les piles rechargeables dans l'appareil en utilisant le câble de recharge USB fourni avec l'appareil.

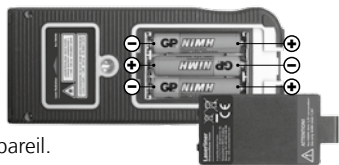

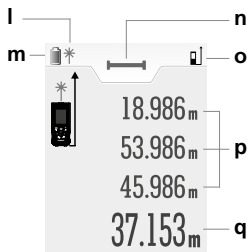
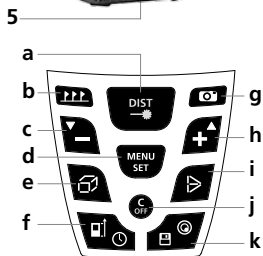

- 1 Champ de réception du laser
- 2 Affichage
- 3 Douille de raccordement pour le bloc d'alimentation USB chargeur
- 4 Compartiment à piles (dos)
- 5 Pointe escamotable
- 6 Sortie du laser
- 7 Caméra

## CLAVIER :

- a MARCHE / Laser activé / Mesurer / Mesure continue mini./maxi.
- b Fonction implantation
- c Fonction de soustraction / Diminuer la valeur / Visualiser les valeurs mesurées mémorisées
- d Menu de réglage / Valider
- e Longueur / Surface / Volume / fonction de surface murale
- f Fonction minuterie / Plan de mesure (référence) avant / filetage / arrière / broche
- g Fonction caméra
- h Fonction d'addition / Augmenter la valeur / Visualiser les valeurs mesurées mémorisées
- i Fonction d'angle / Pythagores 1 + 2 + 3
- j ARRÊT / Suppression des dernières valeurs mesurées
- k Mémoire / bulle numérique

## AFFICHAGE :





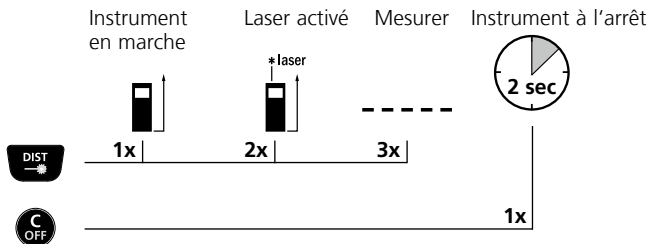

- l Laser activé
- m Symbole des piles
- n Fonction de mesure réglée
- o Plan de mesure (référence) avant / filetage / arrière / broche
- p Valeurs intermédiaires / Valeurs mini./maxi.
- q Valeurs mesurées / Résultats de mesure



## Mise en marche, mesure et arrêt :



## Menu de réglage:

	<b>20</b> sec	Réglage horaire désactivation automatique de l'éclairage de l'afficheur
	<b>060</b> sec	Réglage horaire désactivation automatique du laser
	<b>150</b> sec	Réglage horaire désactivation automatique de l'appareil
	<b>on</b>	Activation/Désactivation du signal sonore
	<b>0.000</b> m	Changer d'unité de mesure : m / ft / ' " / inch
	<b>°</b> / %	Changer d'unité de mesure : ° / %



Sélectionner l'option de réglage



Valider la sélection (symbole vert)



Modifier la valeur



Valider le réglage (symbole rouge)



Enregistrer le réglage (en option)



Quitter le menu

## Effacer la dernière valeur mesurée :



## Commutation au plan de mesure (référence) :

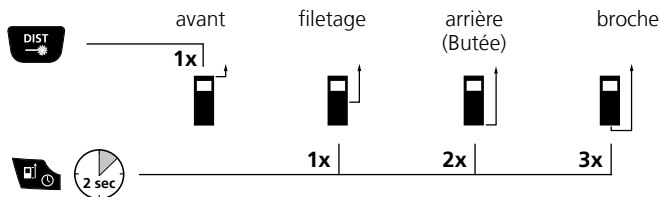

L'appareil démarre avec le dernier réglage.

## Niveau de mesure broche / butée :

Pour des mesures à partir de l'angle, déplier la broche vers le bas et sélectionner le réglage « Niveau de mesure BROCHE ».



Pour des mesures de butée, déplier la broche vers le côté et sélectionner le réglage « Niveau de mesure à l'arrière ».



## Mesure de la longueur :

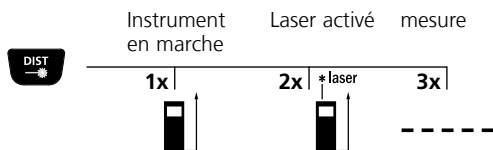

## Addition et soustraction des longueurs :

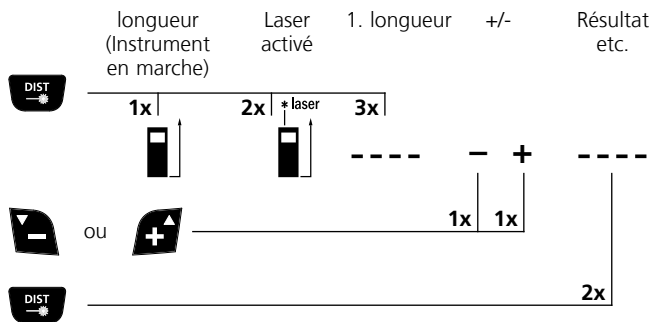

D'autres longueurs sont ajoutées en appuyant sur la touche DIST.

## Mesure continue mini./maxi. :

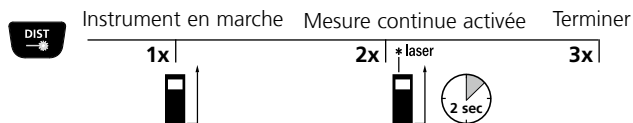

L'écran à cristaux liquides indique la valeur maximale (max.), la valeur minimale (min.), la valeur de différence et la valeur actuelle.

## Mesure de la surface :

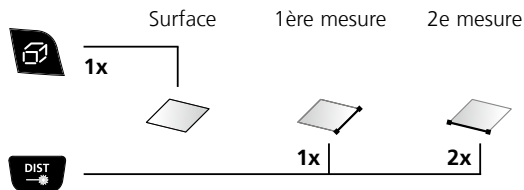

 L'afficheur à cristaux liquides indique en plus le périmètre de la pièce.

## Calcul des surfaces :

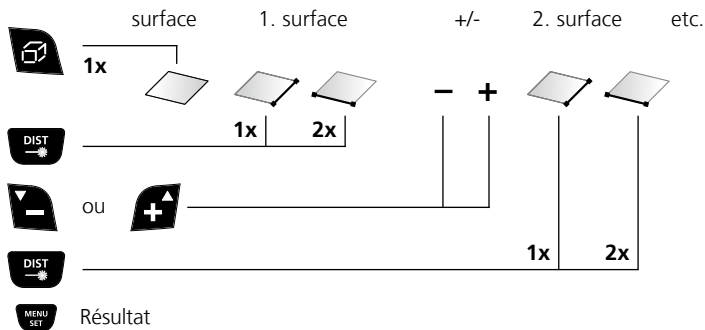

## Mesure du volume :

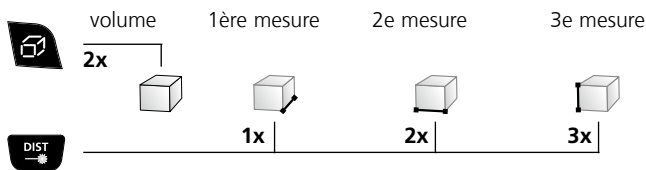

## Calcul des volumes :

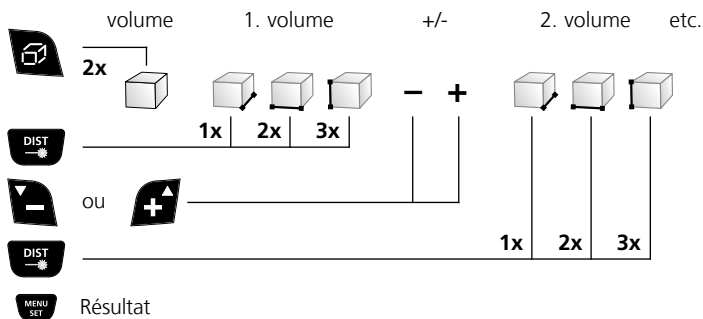

## Adition de la surface / fonction de surface murale :

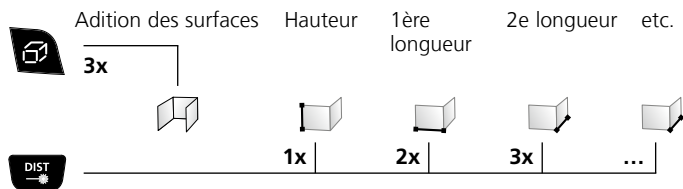

## Fonction d'angle :

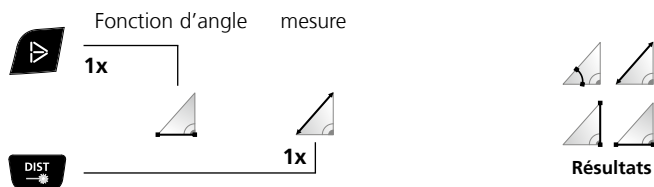

Les résultats de mesure sont calculés automatiquement par le capteur d'inclinaison 360°.

**!** La face arrière de l'appareil sert de surface de référence pour la mesure des angles.

## Fonction Pythagore 1 :

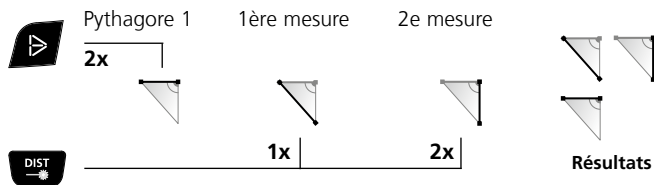

## Fonction Pythagore 2 :

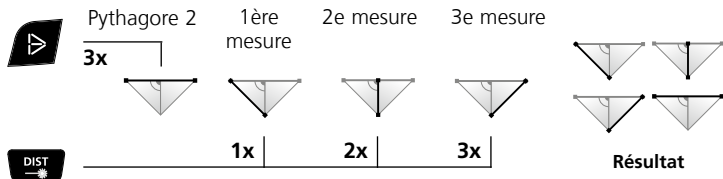

## Fonction Pythagore 3 :

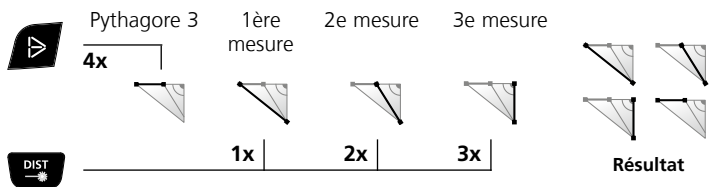

## Fonction implantation :

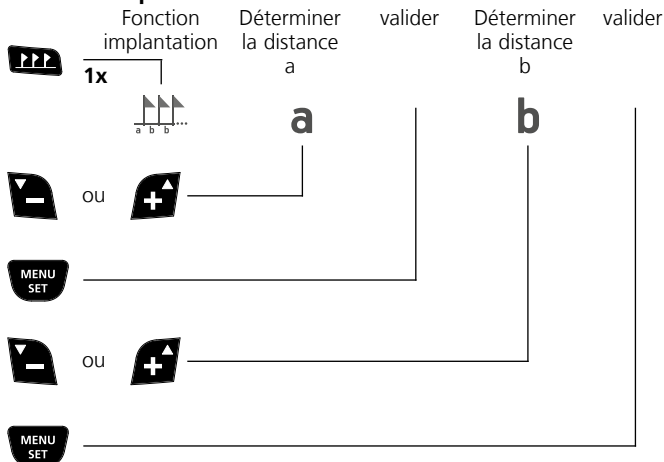

 Pour atteindre l'objectif, faire bouger l'appareil dans le sens de la flèche

 Objectif atteint

 Pour atteindre l'objectif, faire bouger l'appareil dans le sens de la flèche

## Fonction minuterie :

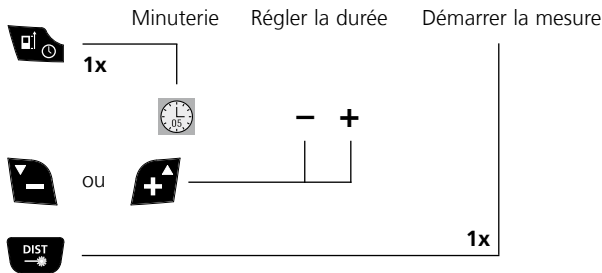

## Fonction caméra :

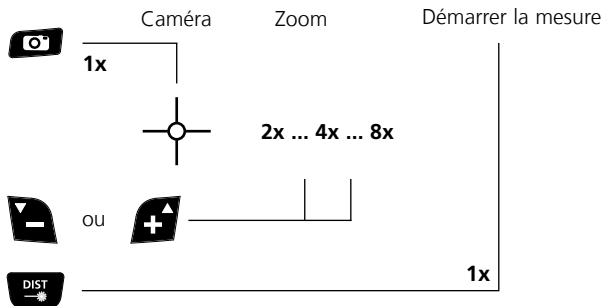

## Bulle numérique :

La bulle numérique sert à aligner des objets.



## Fonction de mémorisation :

L'instrument dispose de 50 emplacements de mémoire.



## Remarques importantes

- Le laser affiche le point jusqu'auquel la mesure sera effectuée. Aucun objet ne doit se dépasser dans le champ du rayon laser.
- Pendant la mesure, l'instrument compense les écarts de température ambiante. En cas d'écarts de température importants, tenez compte d'une courte période d'adaptation suite au changement de lieu.
- L'utilisation de l'instrument à l'extérieur est limitée et il n'est pas possible de l'utiliser en cas de fort ensoleillement.
- La pluie, le brouillard et la neige peuvent influencer voire fausser les mesures à l'air libre.
- L'écart peut être supérieur à 3 mm en cas de mauvaises conditions de mesure par ex. en cas de surfaces à mauvaise réflexion.
- Les tapis, les sièges rembourrés ou les rideaux ne renvoient pas le rayon laser de manière optimale. Utiliser des surfaces lisses.
- Dans le cas de mesures à travers du verre (vitres), il est possible que les résultats de mesure soient faussés.
- Une fonction d'économie d'énergie éteint automatique l'instrument.
- Nettoyage avec une lingette douce. L'eau ne doit pas pénétrer dans le boîtier.

## Code erreur :

Err 1 : Le signal reçu est trop faible

Err 2 : Le signal reçu est trop fort

Err 3 : Echanger les piles

Err 4 : Erreur de mémoire

Err 5 : Erreur dans le calcul avec le théorème de Pythagore

Err 6 : En dehors de la plage de mesure

Err 7 : Erreur dans la caméra

Err 8 : Erreur dans le capteur d'inclinaison



## Données techniques (Sous réserve de modifications techniques 18W19)

<b>Mesure de distances</b>	
Précision (typique)*	± 2 mm
Plage de mesure (à l'intérieur)**	0,05 m - 80 m
<b>Mesures d'angle</b>	
Plage de mesure	± 90°
Laser classer	2 < 1 mW
Longueur de l'onde laser	635 nm
Conditions de travail	-0°C...40°C, Humidité relative de l'air max. 20...85% rH, non condensante, Altitude de travail max. de 2 000 m au-dessus du niveau moyen de la mer
Conditions de stockage	-20°C...60°C, Humidité relative de l'air max. 80% rH
Arrêt automatique	réglable
Alimentation électrique	3 piles (accus) nickel-métal hydrure (NiMH), type AAA 1,2V
Dimensions (L x H x P)	58 x 135 x 30 mm
Poids (piles incluse)	210 g

\* jusqu'à une distance de 10 m avec une surface cible bien réfléchissante et à température ambiante. L'écart de mesure peut atteindre ± 0,2 mm/m en cas de plus grandes distances et de conditions de mesure moins favorables, comme par ex. en cas de fort ensoleillement ou de surfaces cibles à faible réflexion.

\*\* à 10 000 lx max.

## Réglementation UE et élimination des déchets

L'appareil est conforme à toutes les normes nécessaires pour la libre circulation des marchandises dans l'Union européenne.

Ce produit est un appareil électrique et doit donc faire l'objet d'une collecte et d'une mise au rebut sélectives conformément à la directive européenne sur les anciens appareils électriques et électroniques (directive DEEE).

Autres remarques complémentaires et consignes de sécurité sur <http://laserliner.com/info?an=dimavi>

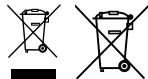

**!** Lea atentamente las instrucciones y el libro adjunto de «Garantía e información complementaria», así como toda la información e indicaciones en el enlace de Internet indicado al final de estas instrucciones. Siga las instrucciones indicadas en ellas. Conserve esta documentación y entréguela con el dispositivo si cambia de manos.

## **Función / Uso**

Distanciómetro láser con función de cámara

- Medición de longitudes, superficies y volumen
- Medición permanente mín/máx, función de superficies murales, función de ángulo, Pitágoras 1 + 2 + 3, función de adición y sustracción, nivel digital, función de replanteo y sensor de inclinación de 360°
- Función de cámara con zoom digital 8x y Viewfinder para visualizar la zona de medición

## **Indicaciones generales de seguridad**

- Utilice el aparato únicamente para los usos previstos dentro de las especificaciones.
- Los instrumentos de medición y los accesorios no son juguetes infantiles. Manténgalos fuera del alcance de los niños.
- No está permitido realizar transformaciones ni cambios en el aparato, en ese caso pierde su validez la homologación y la especificación de seguridad.
- No exponga el aparato a cargas mecánicas, temperaturas muy elevadas, humedad o vibraciones fuertes.
- No se puede seguir utilizando el aparato cuando falla alguna función o la carga de la batería es débil.
- Este aparato ha sido concebido exclusivamente para cargar pilas (baterías) de níquel-hidruro metálico (NiMH), tipo AAA 1,2V.
- No intente cargar otras pilas bajo ningún concepto, ya que podría averiarlo o causar lesiones personales graves.
- Solo carga pilas (baterías) recargables del mismo tamaño, tipo, capacidad y fabricante.
- Por favor respete las medidas de seguridad dispuestas por las autoridades locales o nacionales en relación al uso adecuado del aparato.

## Instrucciones de seguridad

Manejo de láseres de clase 2



Rayo láser!  
¡No mire al rayo láser!  
Láser clase 2  
< 1 mW · 635 nm  
EN 60825-1:2014

- Atención: No mire directamente el rayo ni su reflejo.
- No oriente el rayo láser hacia las personas.
- Si el rayo láser de clase 2 se proyecta en los ojos, ciérrelos inmediatamente y aparte la cabeza de su trayectoria.
- No está permitido manipular (alterar) este dispositivo.
- No mire nunca el rayo láser o las reflexiones con aparatos ópticos (lupa, microscopio, prismáticos, ...).

## Instrucciones de seguridad

Manejo de radiación electromagnética

- El instrumento de medición cumple las normas y limitaciones de compatibilidad electromagnética según la Directiva 2014/30/UE de compatibilidad electromagnética (EMC).
- Es necesario observar las limitaciones de uso locales, por ejemplo en hospitales, aviones, gasolineras o cerca de personas con marcapasos. Se pueden producir efectos peligrosos o interferencias sobre los dispositivos electrónicos o por causa de estos.
- El uso cerca de altas tensiones o bajo campos electromagnéticos alternos elevados puede mermar la precisión de la medición.

## Poner las pilas recargables

Abra el compartimento de baterías y coloque las baterías recargables (3 x NiMH, tipo AAA) respetando los símbolos de instalación. Coloque las pilas en el polo correcto.

Las pilas recargables se pueden cargar en el aparato con el cable de carga adjunto.

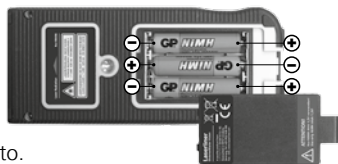

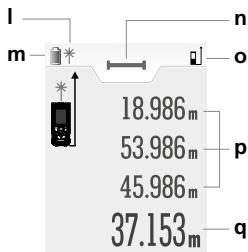
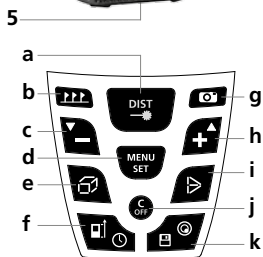

- 1 Campo de receptor láser
- 2 Pantalla
- 3 Entrada para el alimentador de USB cargador
- 4 Compartimento de pilas (dorso)
- 5 Patilla plegable
- 6 Salida del láser
- 7 Cámara

## TECLADO:

- a CON / Láser encendido / Medir / Medición permanente mín./máx.
- b Función de replanteo
- c Función de substracción / Reducir valor / Ver valores de medición almacenados
- d Menú de configuración / Confirmar
- e Longitud / Superficie / Volumen / Función de superficies murales
- f Temporizador / Nivel de medición (referencia) delante / rosca / detrás / pin
- g Función de cámara
- h Función de adición / Aumentar valor / Ver valores de medición almacenados
- i Función de radio / Pitágoras 1 + 2 + 3
- j DES / Borrar los últimos valores de medición
- k Memoria / nivel de burbuja digital

## PANTALLA:

- l Láser activo
- m Símbolo de pilas
- n Función de medición ajustada
- o Nivel de medición (referencia) delante / rosca / detrás / pin
- p Valores intermedios / Valores mín/máx
- q Valores de medición / Resultados

## Conectar, medir y desconectar:

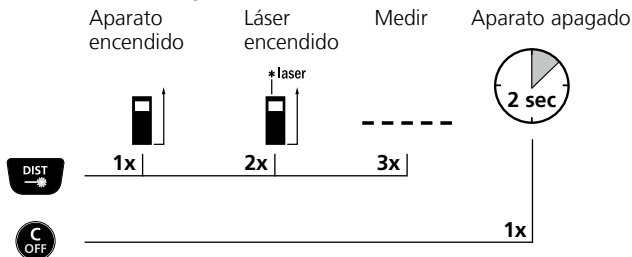

## Menú de configuración:

	<b>20</b> sec	Ajuste horario para la desconexión automática de la iluminación de la pantalla
	<b>060</b> sec	Ajuste horario para la desconexión automática del láser
	<b>150</b> sec	Ajuste horario para la desconexión automática del aparato
	<b>on</b>	Activación/desactivación de señal acústica
	<b>0.000</b> m	Conmutar unidad de medición: m / ft / ' _ ' / inch
	<b>°</b>	Conmutar unidad de medición: ° / %



Seleccionar opción de ajuste



Confirmar selección (marca verde)



Modificar valor



Confirmar ajuste (marca roja)



Guardar ajustes (opcional)



Salir del menú

## Borrar el último valor de medición:



## Conmutar nivel de medición (referencia):

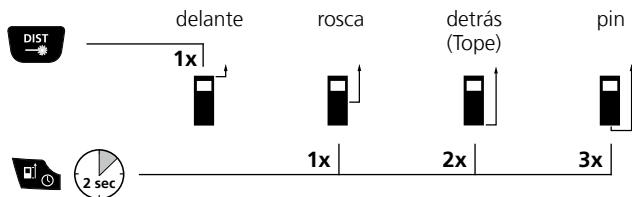

El aparato se inicia con el último ajuste.

## Nivel de medición patilla/tope:

Para mediciones desde la esquina, pliegue la patilla hacia abajo y seleccione el ajuste «Nivel de medición PATILLA»



Para mediciones de tope, pliegue la patilla hacia un lado y seleccione el ajuste «Nivel de medición detrás».



## Medición de longitudes:

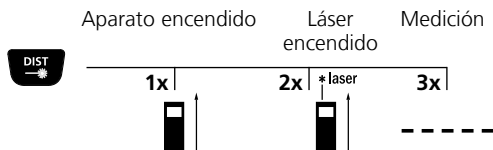

## Adición y sustracción de longitudes:

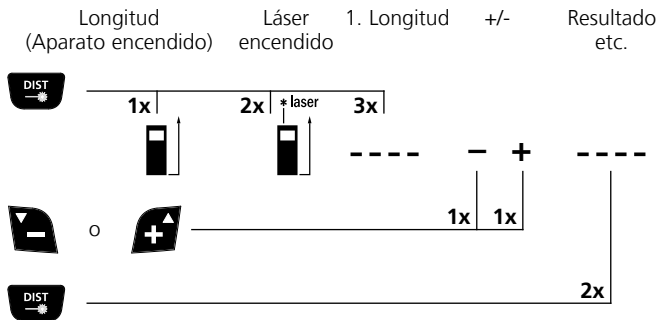

Para otras longitudes, pulse el botón DIST.

## Medición permanente mín./máx.:

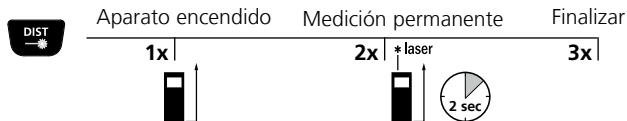

La pantalla LC muestra el valor máximo (máx.), el valor mínimo (mín.), la diferencia y el valor actual.

## Medición de superficies:

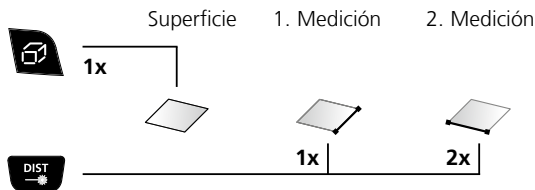

 La pantalla LC muestra un perímetro adicional.

## Cálculo de superficies:

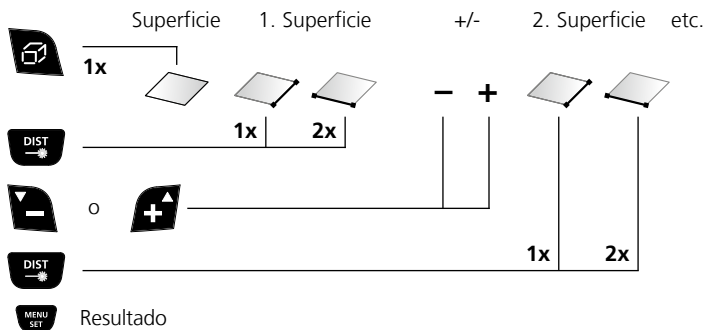

## Medición del volumen:

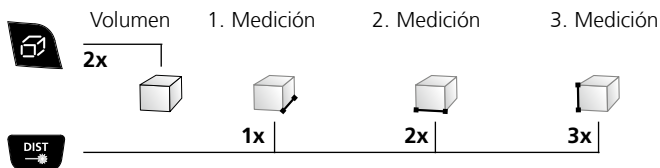

## Cálculo del volumen:

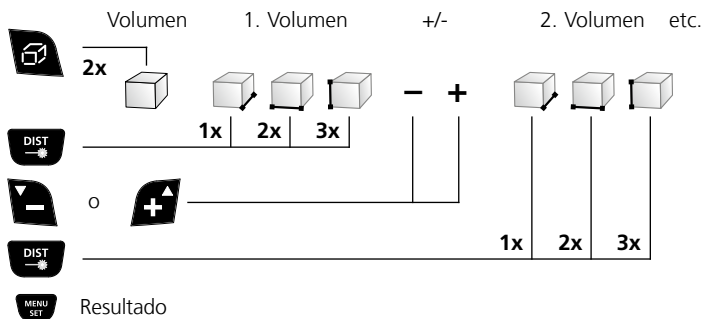



## Adición superficie / Función de superficies murales:

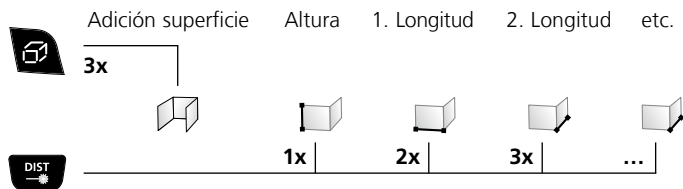

## Función de radio:

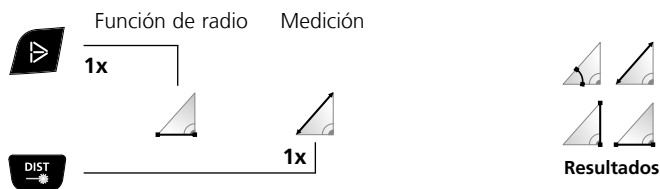

Los resultados de medición se obtienen automáticamente con el sensor de inclinación de 360°.

**!** La parte trasera del dispositivo sirve de superficie de referencia para medir ángulos.

## Función Pitágoras 1:

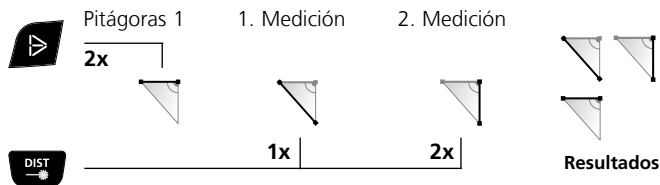

## Función Pitágoras 2:

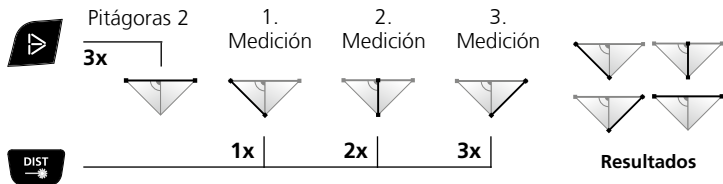

## Función Pitágoras 3:

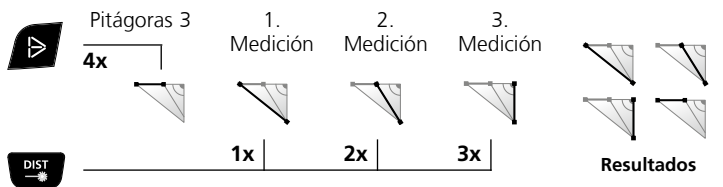

## Función de replanteo:

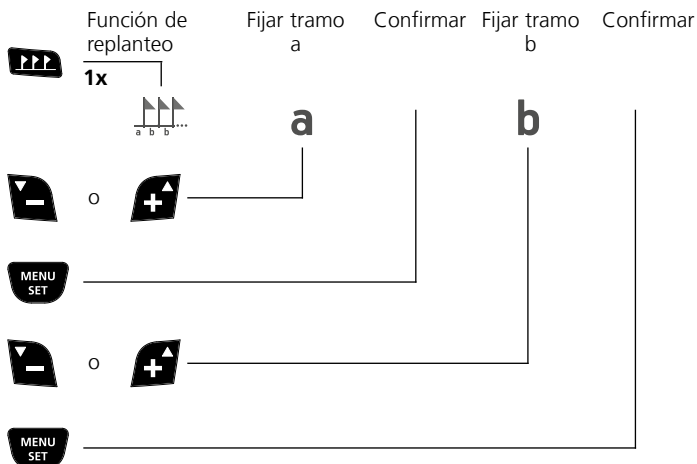

 Para llegar al objetivo, mueva el dispositivo en la dirección de la flecha

 Objetivo alcanzado

 Para llegar al objetivo, mueva el dispositivo en la dirección de la flecha

## Temporizador:

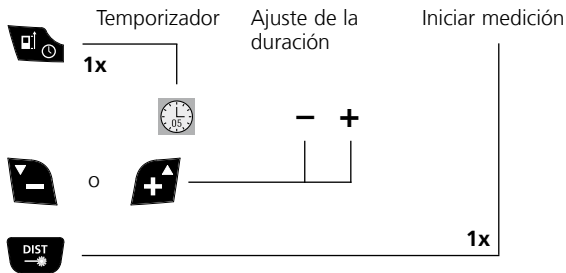

## Función de cámara:

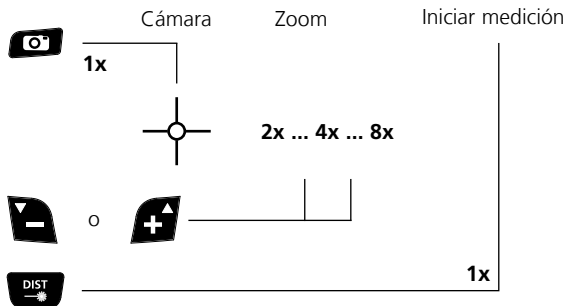

## Nivel de burbuja digital:

El nivel digital sirve para alinear los objetos.



## Función de memoria:

El aparato dispone de 50 posiciones de memoria.



## Avisos importantes

- El láser indica el punto de medición hasta el que se va a medir. En el rayo láser no deben penetrar objetos.
- El aparato compensa diferentes temperaturas ambientales al medir. Por ello considere un tiempo corto de adaptación, al cambiar de lugar con grandes diferencias de temperatura.
- El aparato sólo puede usarse limitadamente en exteriores y no puede usarse con fuertes rayos solares.
- En mediciones en el exterior la lluvia, la niebla y la nieve pueden influir y falsificar los resultados de medición.
- En condiciones desfavorables como p. ej. superficies mal reflectantes la discrepancia máx. puede ser mayor de 3 mm.
- Alfombras, acolchados o cortinas no reflejan el láser óptimamente. Utilice superficies lisas.
- En mediciones a través de cristal (ventanas), pueden falsificarse los resultados de medición.
- Una función economizante de energía desconecta automáticamente el aparato.
- Limpieza con un paño suave. No debe penetrar agua en la caja.

## Código de errores:

- |   |  |
|---|--|
| Err 1: Señal receptora demasiado débil  | Err 5: Error en el cálculo con el teorema de Pitágoras |
| Err 2: Señal receptora demasiado fuerte | Err 6: Fuera de la gama de medición                    |
| Err 3: Cambiar las pilas                | Err 7: Error en cámara                                 |
| Err 4: Error en la memoria              | Err 8: Error en sensor de inclinación                  |

## Datos Técnicos (Salvo modificaciones. 18W19)

### Medición de la distancia

Precisión (típico)*	$\pm 2$ mm
Gama de medición (interiores)**	0,05 m - 80 m

### Medición del ángulo

Rango de medición	$\pm 90^\circ$
-------------------	----------------

Clase de láser	2 < 1 mW
----------------	----------

Longitud de onda del láser	635 nm
----------------------------	--------

Condiciones de trabajo	-0°C...40°C, Humedad del aire máx. 20...85% r.h., No condensante, Altitud de trabajo máx. 2000 m sobre el nivel del mar (nivel normal cero)
------------------------	---

Condiciones de almacén	-20°C...60°C, Humedad del aire máx. 80% r.h.
------------------------	--

Apagado automático	ajustable
--------------------	-----------

Alimentación	3 pilas (baterías) de níquel-metal hidruro (NiMH), tipo AAA 1,2V
--------------	--

Dimensiones (An x Al x F)	58 x 135 x 30 mm
---------------------------	------------------

Peso (pilas incluida)	210 g
-----------------------	-------

\* Distancia de medición hasta 10 m con superficies reflectantes y a temperatura ambiente. Con distancias mayores y condiciones desfavorables, como fuerte radiación solar o superficies de baja reflexión, puede aumentar la tolerancia de las mediciones en  $\pm 0,2$  mm/m.

\*\* Con un máximo de 10.000 lux

## Disposiciones europeas y eliminación

El aparato cumple todas las normas requeridas para el libre tráfico de mercancías en la UE.

Se trata de un aparato eléctrico, por lo que debe ser recogido y eliminado por separado conforme a la directiva europea relativa a los aparatos eléctricos y electrónicos usados.

Más información detallada y de seguridad en:

<http://laserliner.com/info?an=dimavi>

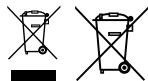





# DistanceMaster Vision



SERVICE



**Umarex GmbH & Co. KG**

– Laserliner –

Möhnstraße 149, 59755 Arnsberg, Germany

Tel.: +49 2932 638-300, Fax: +49 2932 638-333

info@laserliner.com

8.081.96.53.1 / Rev18W19

Umarex GmbH & Co. KG

Donnerfeld 2

59757 Arnsberg, Germany

Tel.: +49 2932 638-300, Fax: -333

www.laserliner.com



**Laserliner**