

› GN Smart Series

Smart Solid State Relays

GNS Smart Current & Load Detection

- › Output Current of 35 A, 50 A and 75 Amps
- › Special Zero cross (resistive, inductive, capacitive)
- › Current and Load Detection
- › Normally open/close alarm output
- › LED Input status indicator
- › Load Detection: Removable connector
- › Current Detection: Screw connector



Load Detection Version



Current & Load Detection Version

Product Selection - Special Zero Cross (resistive, inductive, capacitive)			
Rated Load Current	35A	50A load	75A
Output Voltage	50-265 V~	150-510 V~	150-510 V~
Control Voltage			
8-30 V _{DC}	84139150N	84139120N	84139130N

Product Selection - Special Zero Cross (resistive, inductive, capacitive)	
Rated Load Current	50A current
Output Voltage	24-600 V~
Control Voltage	
4-32 V _{DC}	84136120N

PART NUMBERING SYSTEM

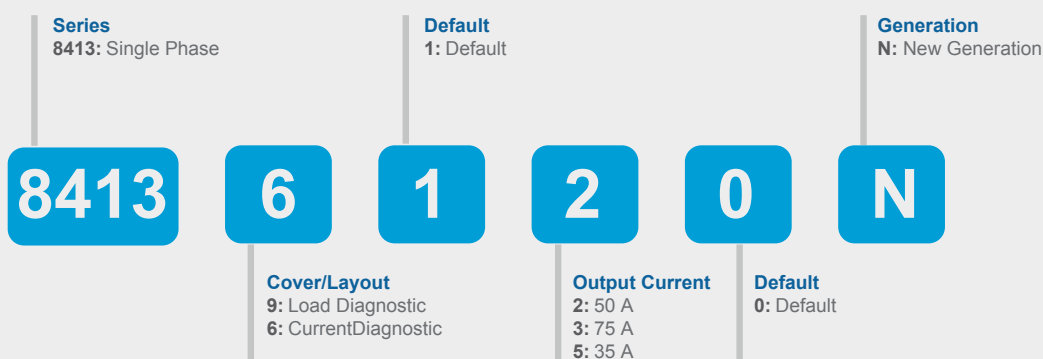

Do you need an adapted or customized solution? Contact us on www.crouzet.com

Description:

Crouzet Solid State Relays are designed to be used in almost any application, offering very long life expectancy and are easy to install, easy to use, robust and multipurpose.

For more information about Crouzet's Solid State relays, please visit www.crouzet.com.

Accessories		
Type	Description	Part-Number
Heatsink	0.9 °C/W Thermal Resistance	26532752N
Heatsink	1.1 °C/W Thermal Resistance	26532753N
Heatsink	1.2 °C/W Thermal Resistance	26532754N
Heatsink	1.75 °C/W Thermal Resistance	26532755N
Heatsink	2.2 °C/W Thermal Resistance	26532756N
Adapter	DIN Rail	26532764N
Thermal Pad	Self-Adhesive Thermal Pad	26532722N
Screws	Screw Mounting Kit	26532001
Thermal Grease	Thermal Grease for Heatsink mounting	26532003

Output Specifications ⁽¹⁾				
Description	35A	50A load	50A current	75A
Maximum Load Current [Arms] ⁽³⁾	35	50		75
Minimum Load Current [mArms]	5			
Operating Voltage (47-63Hz) [Vrms]	50-265	24-625	150-510	
Transient Voltage [Vpeak]	1200	1600	1200	
Maximum Off-State Leakage Current @ Rated Voltage [mArms]	5	1	5	
Minimum Off-State dV/dt @ Maximum Rated Voltage [V/μsec]	500			
1 Second Surge Current (Apk. Ta=25 °C) 50/60 Hz	165	230		347
Maximum 1 Cycle Surge Current (50/60Hz) [Apeak] Typ @ 50 Hz	530/_ (min) 580 (typ)	700/_ (min) 750 (typ)		1100/_ (min) 1200 (typ)
Maximum On-State Voltage Drop @ Rated Current [Vpeak]	1.11	1.38		1.34
Thermal Resistance Junction to Case (Rjc) [°C/W]	0.55	0.4		0.3
Maximum 1/2 Cycle I ² t for Fusing @ 50 Hz (min. typical) [A ² sec]	1404/1680	2450/2800		6000/7200
Minimum Heat Sink for Rated Current @ 40 °C [°C/W]	1.8	0.84		0.52

Input Specifications		
Description	8-30 V _{DC}	4-32 V _{DC}
Control Voltage Range	7-30 V _{DC}	3.5-32 V _{DC}
Maximum Reverse Voltage	-32 V _{DC}	
Minimum Turn-On Voltage	7 V _{DC}	3.5 V _{DC}
Must Turn-Off Voltage	3 V _{DC}	2 V _{DC}
Minimum Input Current (for on-state)	4 mA	10 mA
Maximum Input Current [mA]	30 mA	14 mA
Nominal Input Impedance [Ohms]	1 K	Current Limited
Maximum Turn-On Time [msec]	1/2 Cycle ⁽⁵⁾	
Maximum Turn-Off Time [msec]	1/2 Cycle ⁽⁵⁾	

General Specifications				
Description	35A	50A load	50A current	75A
Dielectric Strength, Input/Output to Ground (50/60Hz)	4000 Vrms			
Minimum Insulation Resistance (@ 500 V _{DC})	10 ⁹ Ω			
Maximum Capacitance, Input/Output	0.8 pF			
Ambient Operating Temperature Range	-40 to 80 °C			
Ambient Storage Temperature Range	-40 to 100 °C			
Weight (typical)	80 g			

General Specifications				
Description	35A	50A load	50A current	75A
Housing Material	UL94 V-0			
Baseplate Material	Aluminum			
Input Terminal Screw Torque Range (in-lb/Nm) - 84136120 N	4.4 -5.3 / 0.5-0.6			
Load Terminal Screw Torque Range (in-lb/Nm)	18-26 / 2-3			
SSR Mounting Screw Torque Range (in-lb/Nm)	11-16 / 1.2-1.8			
Humidity per IEC60068-2-78	40-85 %			
LED Input Status Indicator	Green			
MTBF (Mean Time Between Failures) at 40 °C ambient temperature (years)	48			
MTBF (Mean Time Between Failures) at 60 °C ambient temperature (years)	32			

Alarm Specifications		
Description	Load Detection	Current Detection
Max. Output voltage	32 V _{rms}	
Max. Output current	0.1 A	
On state drop voltage	0.2 V	1.4 V
Turn-off time	120 ms	70 ms
Turn-on time	20 ms	10 ms
Turn-on current	-	0.9 A
Turn-off current	-	0.74 A
On state resistance	2	-
Open Delay	70 ms	-
Total Open Delay	120 ms	-
Checked Delay (voltage)	20 ms	-
Checked Delay (current)	20 ms	-

General Notes
⁽¹⁾ All parameters at 25 °C unless otherwise specified
⁽²⁾ Heat sinking required, see derating curves.
⁽⁴⁾ Increase minimum voltage by 1 V for operations from -20 to -40 °C.
⁽⁵⁾ All parameters at 50 % power rating and 100 % duty cycle (contact tech support for detailed report).

Diagrams
Wiring

GNS Smart - Load Detection

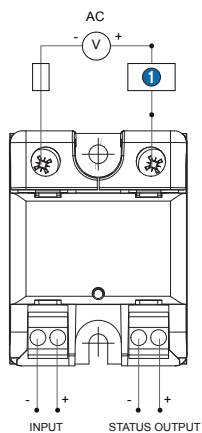

GNS Smart - Current Detection

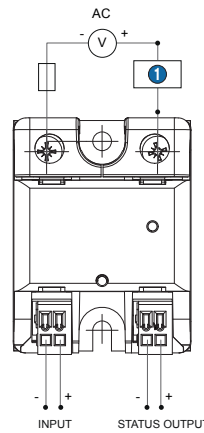

GNS

- 1 Load

Diagrams

Equivalent Circuit Block

GNS Smart - Load Detection

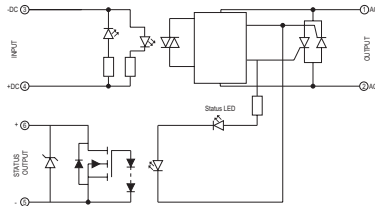

GNS Smart - Current Detection

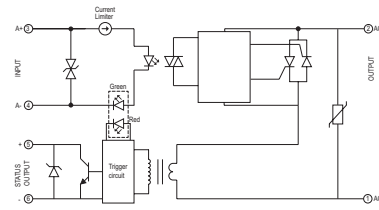

Status Output

- 5 Normally Closed contact, max 0.1 A 32 V~
- 6 Normally Closed contact, max 0.1 A 32 V~

Diagrams

Status Chart

LED Status - Load Detection

STATUS	LED control status	Mains	Charge	Thyristor	LED alarm status	Diagnostic OUTPUT
No power	<input type="checkbox"/>	No	-	-	<input type="checkbox"/>	OPEN
Open Mains	<input checked="" type="checkbox"/>	No	-	-	<input type="checkbox"/>	OPEN
Normal operation (without control)	<input type="checkbox"/>	Yes	OK	OK	<input checked="" type="checkbox"/>	CLOSED
Normal operation	<input checked="" type="checkbox"/>	Yes	OK	OK	<input type="checkbox"/>	CLOSED
Open load (without control)	<input type="checkbox"/>	Yes	Open	OK	<input type="checkbox"/>	OPEN
Open load	<input checked="" type="checkbox"/>	Yes	Open	OK	<input type="checkbox"/>	OPEN
Short Circuit SSR (without control)	<input type="checkbox"/>	Yes	OK	Short circuit	<input type="checkbox"/>	OPEN
Short Circuit SSR	<input checked="" type="checkbox"/>	Yes	OK	Short circuit	<input type="checkbox"/>	OPEN

LED Status - Current Detection

STATUS	INPUT	OUTPUT LED status	Diagnostic OUTPUT
Load Current > 4 A	ON	■	OPEN
0.8 A < Load Current < 4 A	ON	■	CLOSED
Load Current < 0.8 A	ON	■	CLOSED
Load Current > 0.8 A (Short circuit SSR)	OFF	■	OPEN
Load Current < 0.8 A	OFF	<input type="checkbox"/>	OPEN

Diagrams

Dimensions (mm)

GNS Smart front view - Current Detection

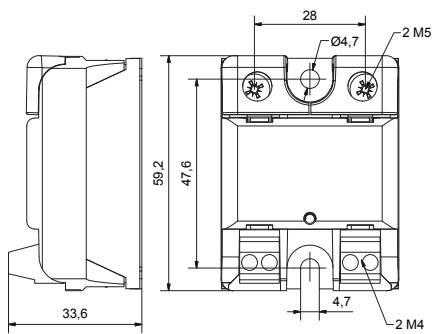

GNS Smart side view - Current Detection

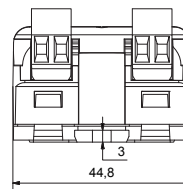

GNS Smart front view - Load Detection

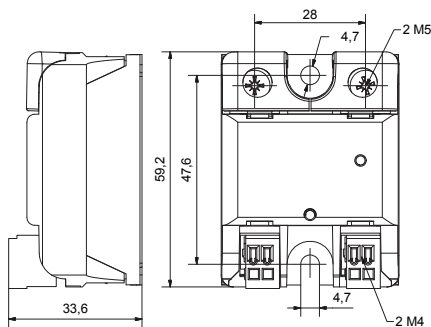

GNS Smart side view - Load Detection

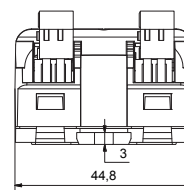

Curves

Surge Current Information

GNS - 35 A

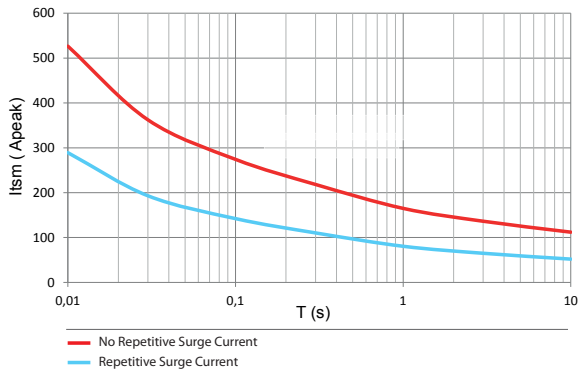

GNS - 50 A

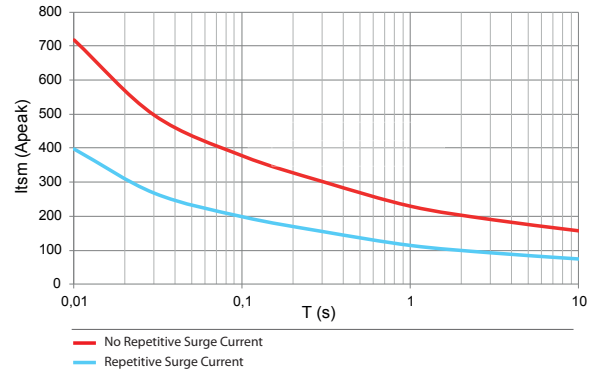

GNS - 75 A

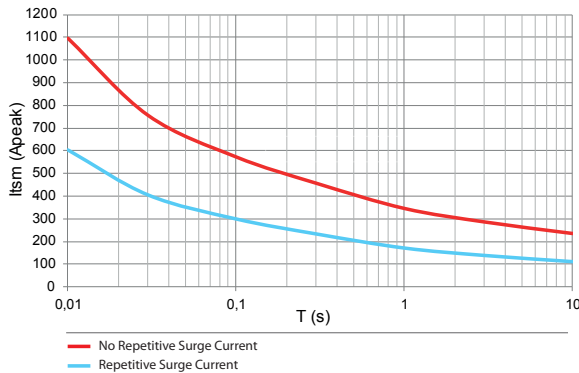

GNS - 50 A Current Detection

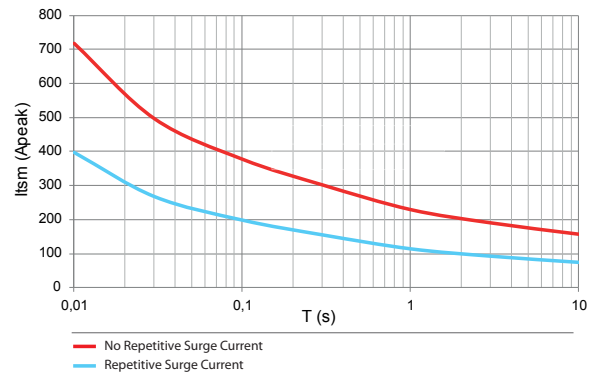

Curves

Thermal Derating Curves

GNS - 84139150N

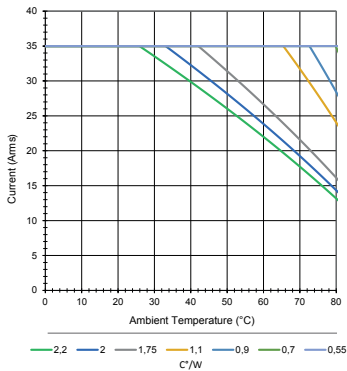

GNS - 84139120N / 84136120N

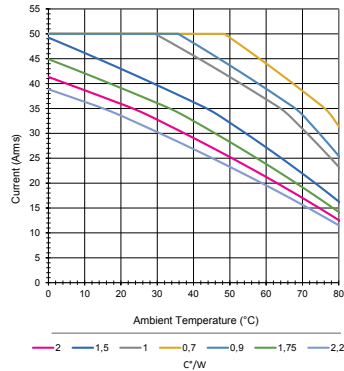

GNS - 84139130N

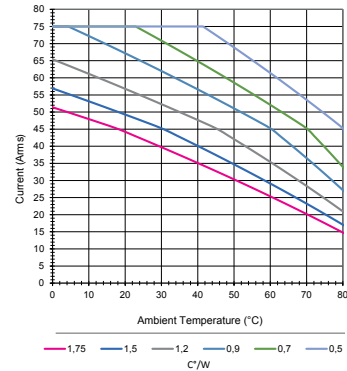

Warning:

The product information contained in this catalogue is given purely as information and does not constitute a representation, warranty or any form of contractual commitment. Crouzet and its subsidiaries reserve the right to modify their products without notice. It is imperative that we should be consulted over any particular use or application of our products and it is the responsibility of the buyer to establish, particularly through all the appropriate tests, that the product is suitable for the use or application. Under no circumstances will our warranty apply, nor shall we be held responsible for any application (such as any modification, addition, deletion, use in conjunction with other electrical or electronic components, circuits or assemblies, or any other unsuitable material or substance) which has not been expressly agreed by us prior to the sale of our products.

Standard Specifications84139150N / 84139120N / 84139130N

IEC/EN61000-4-4 (bursts)	2 kv crit A
IEC/EN61000-4-5 (surge)	2 kv crit B
VIBRATION resistance IEC 60068-2-6	10 g
SHOCK resistance IEC 60068-2-27	50 G (11 ms)

84136120N

IEC/EN61000-4-4 (bursts)	2 kv crit A
IEC/EN61000-4-5 (surge)	2 kv crit A
VIBRATION resistance IEC 60068-2-6	10 g
SHOCK resistance IEC 60068-2-27	50 G (11 ms)



* VDE ONLY 84139150N / 84139120N / 84139130N