



■ Features

- Constant Voltage PWM style output with user changeable frequency up to 4KHz compliant IEEE1789-2015 no risk
- Plastic housing with class II design
- Built-in active PFC function
- Standby power consumption<0.5W
- Integrated KNX control protocol
- No need KNX-DALI gateway
- Typical lifetime>50000 hours
- 5 years warranty

■ Applications

- LED strip lighting
- Indoor LED lighting
- LED decorative lighting
- LED architecture lighting

■ Description

■ Model Encoding

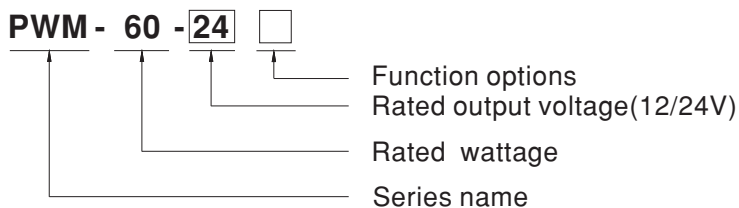

Type	Function	Note
KN	KNX control technology	In stock
KNBST	KNX control technology with BST14 connector	by request



SPECIFICATION

MODEL		PWM-60-12□	PWM-60-24□
OUTPUT	DC VOLTAGE	12V	24V
	RATED CURRENT	5A	2.5A
	RATED POWER	60W	60W
	DIMMING RANGE	0 ~ 100%	
	PWM FREQUENCY (Typ.)	200~4000Hz user changable via ETS	
	SETUP, RISE TIME Note.2	500ms, 80ms/ 115VAC or 230VAC	
	HOLD UP TIME (Typ.)	16ms/115VAC or 230VAC	
INPUT	VOLTAGE RANGE Note.3	90 ~ 305VAC 127 ~ 431VDC (Please refer to "STATIC CHARACTERISTIC" section)	
	FREQUENCY RANGE	47 ~ 63Hz	
	POWER FACTOR (Typ.)	PF>0.97/115VAC, PF>0.95/230VAC, PF>0.92/277VAC @ full load (Please refer to "POWER FACTOR (PF) CHARACTERISTIC" section)	
	TOTAL HARMONIC DISTORTION	THD< 20%(@load≥60%/115VAC, 230VAC; @load≥75%/277VAC) (Please refer to "TOTAL HARMONIC DISTORTION" section)	
	EFFICIENCY (Typ.)	86%	89%
	AC CURRENT (Typ.)	0.8A / 115VAC 0.4A / 230VAC 0.32A / 277VAC	
	INRUSH CURRENT (Typ.)	COLD START 50A(twidth=350μs measured at 50% Ipeak) at 230VAC; Per NEMA 410	
	MAX. NO. of PSUs on 16A CIRCUIT BREAKER	9 units (circuit breaker of type B) / 16 units (circuit breaker of type C) at 230VAC	
	LEAKAGE CURRENT	<0.25mA / 277VAC	
	STANDY POWER CONSUMPTION	<0.5W	
PROTECTION	OVERLOAD	108 ~ 130% rated output power Hiccup mode, recovers automatically after fault condition is removed	
	SHORT CIRCUIT	Shut down o/p voltage, re-power on to recover	
	OVER VOLTAGE	15 ~ 17V	28 ~ 34V
		Shut down o/p voltage, re-power on to recover	
	OVER TEMPERATURE	Shut down o/p voltage, re-power on to recover	
ENVIRONMENT	WORKING TEMP.	Tcase=-35 ~ +85°C (Please refer to " OUTPUT LOAD vs TEMPERATURE" section)	
	MAX. CASE TEMP.	Tcase=+85°C	
	WORKING HUMIDITY	20 ~ 95% RH non-condensing	
	STORAGE TEMP., HUMIDITY	-35 ~ +80°C, 10 ~ 95% RH	
	TEMP. COEFFICIENT	±0.03%/°C (0 ~ 50°C)	
	VIBRATION	10 ~ 500Hz, 5G 12min./1cycle, period for 72min. each along X, Y, Z axes	
SAFETY & EMC	SAFETY STANDARDS Note.5	ENEC EN61347-1, EN61347-2-13, EN62384 independent, GB19510.14, GB19510.1, EAC TP TC 004 approved	
	KNX STANDARDS	Certified protocol	
	WITHSTAND VOLTAGE	I/P-O/P:3.75KVAC	
	ISOLATION RESISTANCE	I/P-O/P:100M Ohms / 500VDC / 25°C / 70% RH	
	EMC EMISSION Note.6	Compliance to EN55015, EN61000-3-2 Class C (@load≥60%) ; EN61000-3-3, GB17743 and GB17625.1, EAC TP TC 020	
	EMC IMMUNITY	Compliance to EN61000-4-2,3,4,5,6,8,11; EN61547, light industry level (surge immunity Line-Line 2KV), EAC TP TC 020	
OTHERS	MTBF	996K hrs min. Telcordia SR-332 (Bellcore) ; 271.03K hrs min. MIL-HDBK-217F (25°C)	
	DIMENSION	150*53*35mm (L*W*H)	
	PACKING	0.45Kg;30pcs/16.0Kg/1.0CUFT	
NOTE	<ol style="list-style-type: none"> All parameters NOT specially mentioned are measured at 230VAC input, rated current and 25°C of ambient temperature. De-rating may be needed under low input voltages. Please refer to "STATIC CHARACTERISTIC" sections for details. Length of set up time is measured at first cold start. Turning ON/OFF the driver may lead to increase of the set up time. The driver is considered as a component that will be operated in combination with final equipment. Since EMC performance will be affected by the complete installation, the final equipment manufacturers must re-qualify EMC Directive on the complete installation again. This series meets the typical life expectancy of >50,000 hours of operation when Tcase, particularly (Tc) point (or TMP, per DLC), is about 75°C or less. Please refer to the warranty statement on MEAN WELL's website at http://www.meanwell.com The ambient temperature derating of 3.5°C/1000m with fanless models and of 5°C/1000m with fan models for operating altitude higher than 2000m(6500ft). For any application note and IP water proof function installation caution, please refer our user manual before using. https://www.meanwell.com/Upload/PDF/LED_LED_EN.pdf 		

■ DIMMING OPERATION

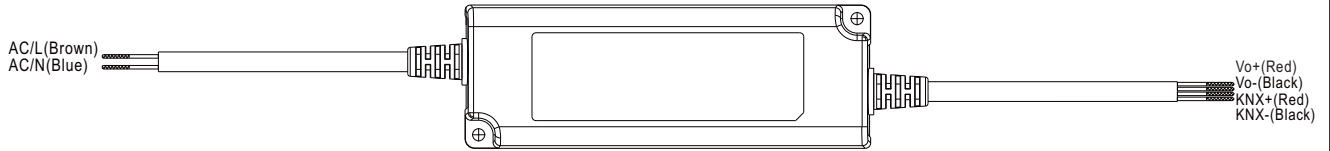

※ Dimming principle for PWM style output

Dimming is achieved by varying the duty cycle of the output current.

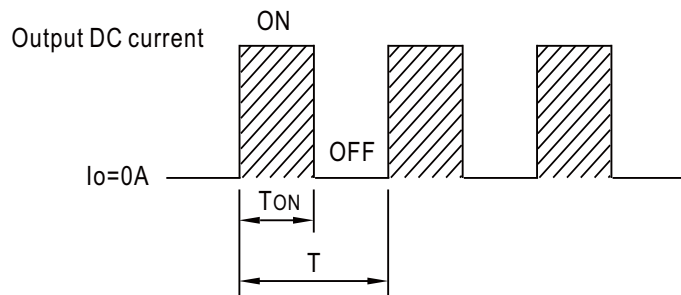

$$\text{Duty cycle(\%)} = \frac{T_{\text{ON}}}{T} \times 100\%$$

Output PWM frequency up to 4KHz

※ KNXInterface

- Apply KNX signal between KNX+ and KNX-.
- The application program(database) can be downloaded via Online Catalogs from ETS or via <http://www.meanwell.com/productCatalog.aspx>

Parametrization options	Description
Switch functions	<ul style="list-style-type: none"> • Turn on brightness • Dimming speed for turn on/off • Switch telegram and status • Switch on/off delay
Dimming	<ul style="list-style-type: none"> • Dimming speed for 0~100% • Allow switch on via relative dimming
Brightness value	<ul style="list-style-type: none"> • Dimming speed for transition brightness values • Permit set switch on and off brightness via value • Brightness value and status
Fault message	<ul style="list-style-type: none"> • Lamp fault
Other functions	<ul style="list-style-type: none"> • Reaction on KNX voltage failure/recovery • Power-On level • Dimming curve select(linear/log) • Block function(Block1&Block2) • Staircase lighting function(multi-stage switch-off) • Output PWM frequency value
General function	<ul style="list-style-type: none"> • Cyclic monitoring telegram(In operation)
8 Scenes	<ul style="list-style-type: none"> • Recall and save via KNX with 8-bit telegram
Operating hours & CLO	<ul style="list-style-type: none"> • Operating hours counter • Constant light out(5 scheduled divisions)
Power consumption feedback	<ul style="list-style-type: none"> • Power consumption report
Temperature measurement	<ul style="list-style-type: none"> • Temperature report, optional to report Tunit/Tamb temperature • Tunit: Unit internal temperature • Tamb: Conver Tunit to ambient temperature • Temperature Alarm protection • Eliminate temperature Alarm protection via object/automatic

OUTPUT LOAD vs TEMPERATURE

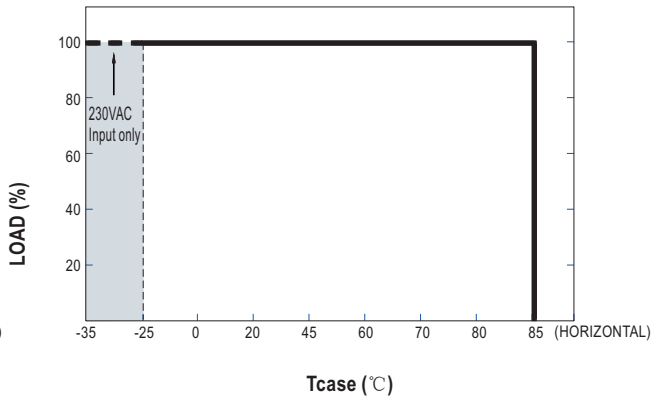
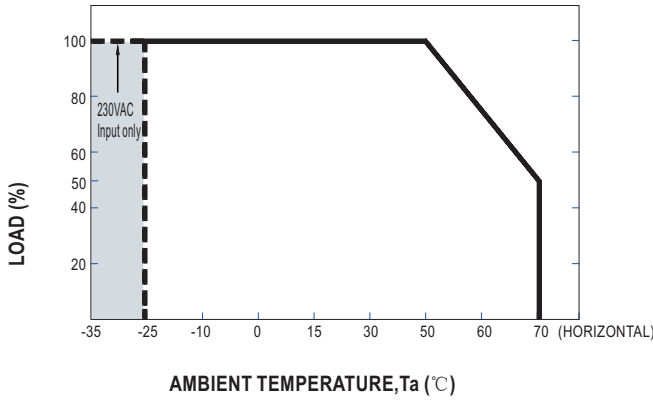

STATIC CHARACTERISTIC

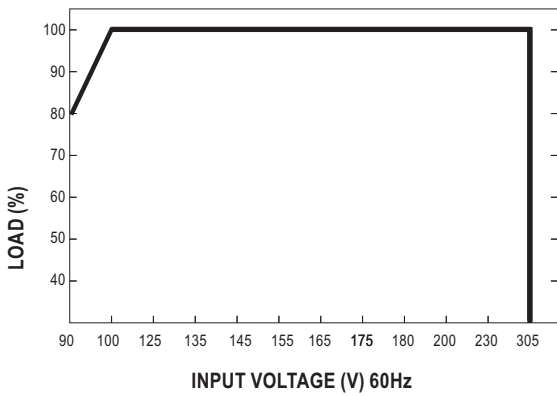

※ De-rating is needed under low input voltage.

POWER FACTOR (PF) CHARACTERISTIC

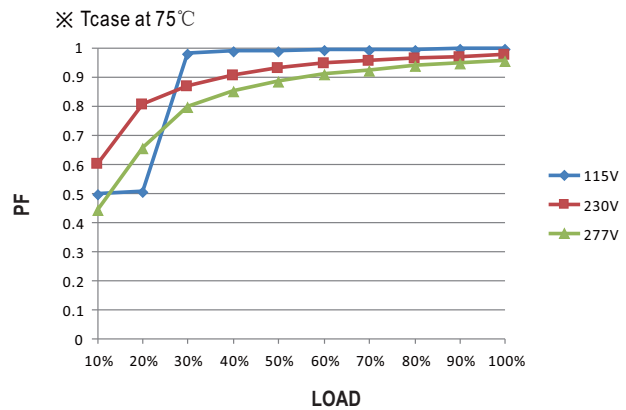

TOTAL HARMONIC DISTORTION (THD)

※ 24V Model, T_{case} at $75^\circ C$

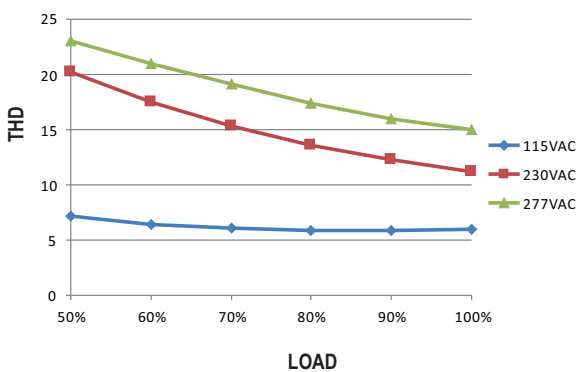

EFFICIENCY vs LOAD

PWM-60-KN series possess superior working efficiency that up to 89% can be reached in field applications.

※ 24V Model, T_{case} at $75^\circ C$

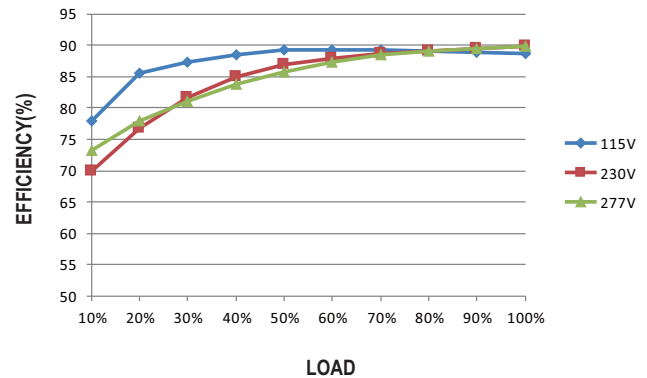

■ LIFE TIME

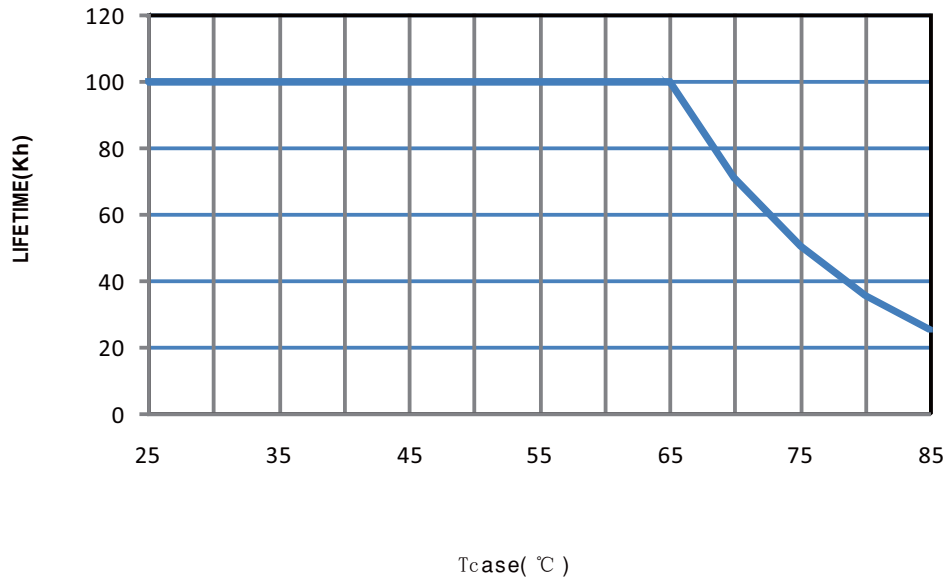

Block Diagram

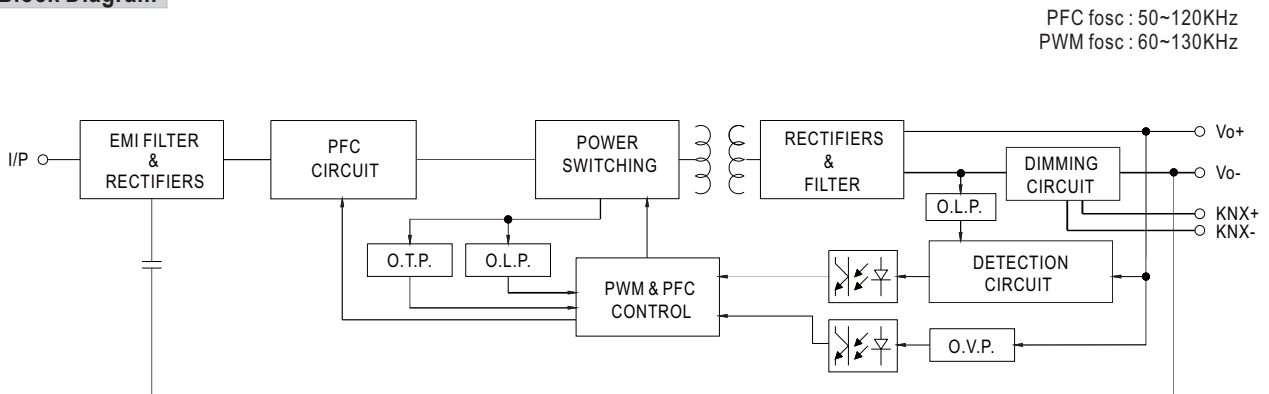

Note: PWM fosc here is not related to output PWM dimming

Mechanical Specification

Case No. PWM-60KN Unit:mm

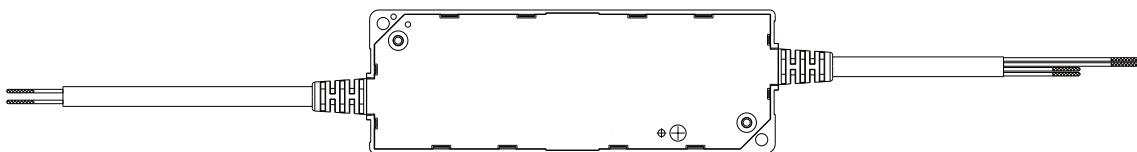
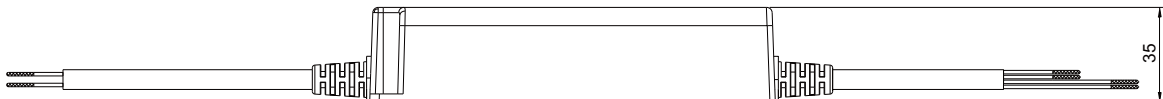
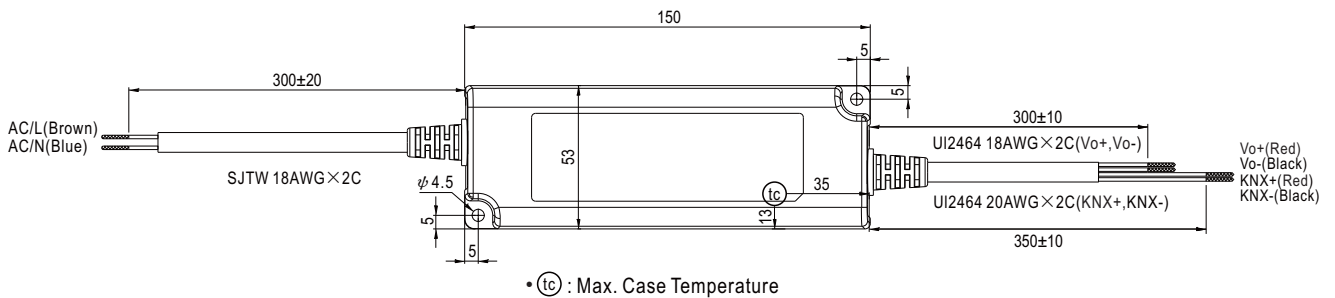

Mechanical view of by request

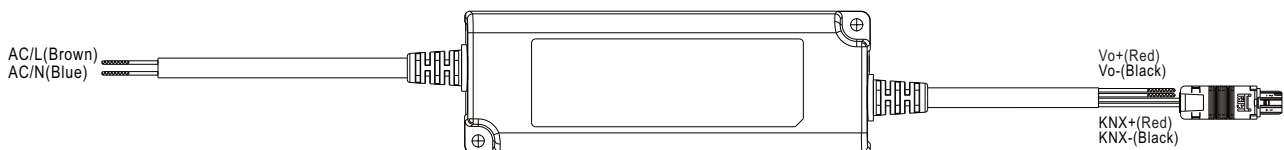

■ Recommend Mounting Direction

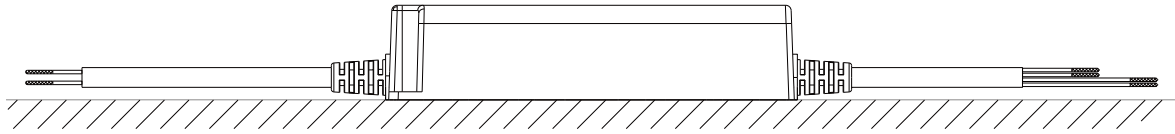

■ Installation Manual

◎ Connection for KNX-type

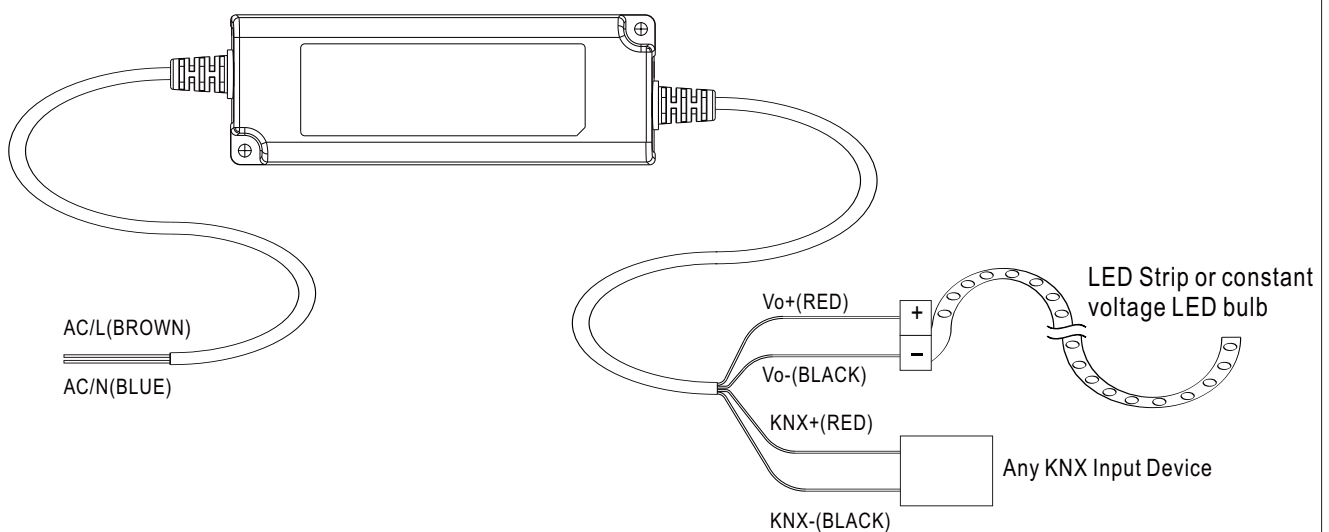

PWM KN series can be ETS addressing/programming WITHOUT connecting to AC mains

◎ Cautions

- Before commencing any installation or maintenance work, please disconnect the power supply from the utility. Ensure that it cannot be re-connected inadvertently!
- Keep proper ventilation around the unit and do not stack any object on it. Also a 10-15 cm clearance must be kept when the adjacent device is a heat source.
- Mounting orientations other than standard orientation or operate under high ambient temperature may increase the internal component temperature and will require a de-rating in output current.
- Current rating of an approved primary /secondary cable should be greater than or equal to that of the unit. Please refer to its specification.
- For LED drivers with waterproof connectors, verify that the linkage between the unit and the lighting fixture is tight so that water cannot intrude into the system.
- Tc max. is identified on the product label. Please make sure that temperature of Tc point will not exceed limit.
- DO NOT connect "KNX- to Vo-".
- The power supply is considered as a component that will be operated in combination with final equipment. Since EMC performance will be affected by the complete installation, the final equipment manufacturers must re-qualify EMC Directive on the complete installation again.
- For more information about installation, Please refer to : <http://www.meanwell.com/manual.html> for details.