

EXTRUSION

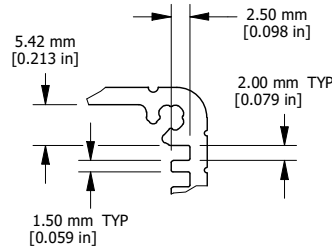

DETAIL A

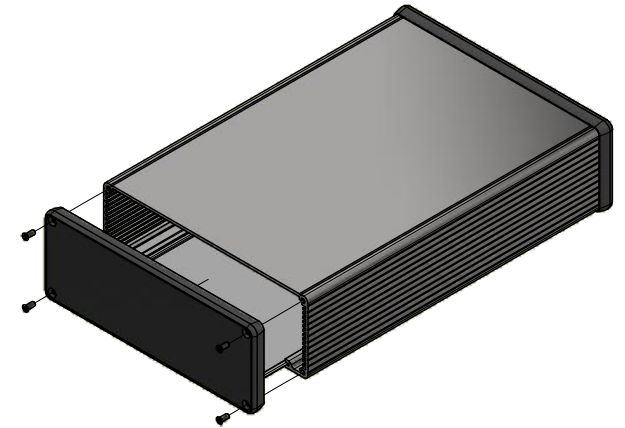

EXPLODED ISOMETRIC VIEW

EXTRUSION DESIGNED FOR 160MM WIDE PC BOARD

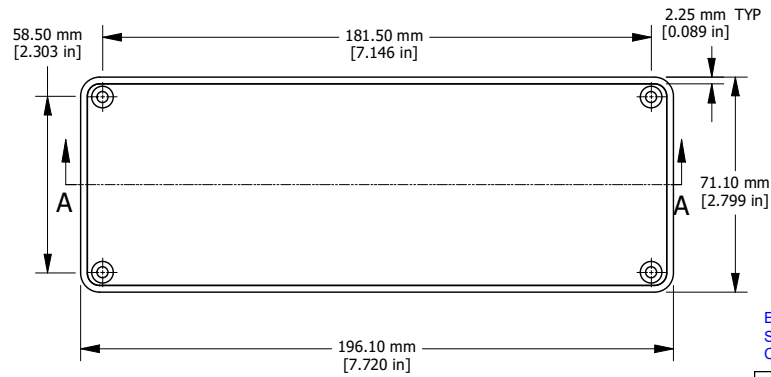
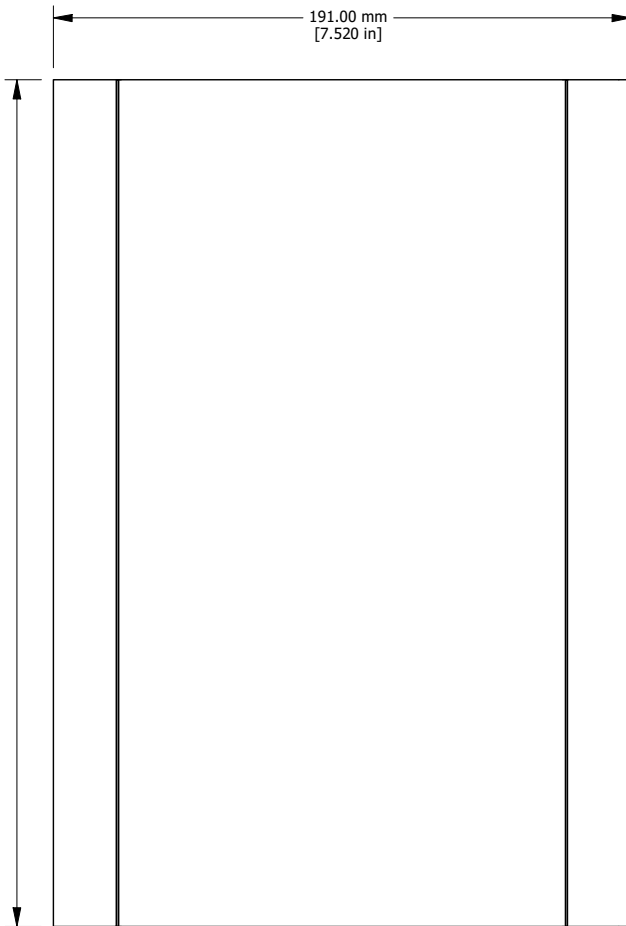

CLOSED BEZEL

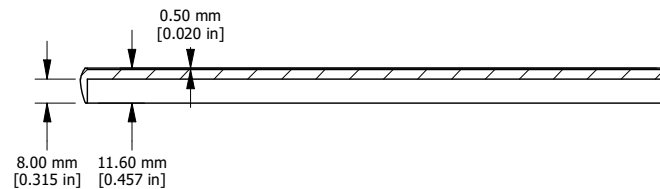

SECTION A-A

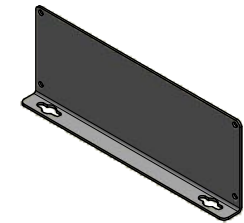

OPTIONAL FLANGED  
END PANELS 1455UF

Enclosures can be Factory Modified ( Milling, Drilling, Printing etc. )  
Solid models of this enclosure available in STEP or IGES.  
Contact Factory [mjm@hammondmfg.com](mailto:mjm@hammondmfg.com)

**NOTE**

Purchased assembly includes box, plastic bezels, #6 Taptight screws and self adhesive rubber feet.  
Box made from Extruded Aluminum 6063.  
Bezels made with ABS.

**1455U2802**

**PART NUMBERS**

Clear Anodized	1455U2802
Black Anodized	1455U2802BK

**ACCESSORIES**

See website for accessories.



**HAMMOND  
MANUFACTURING™**

**1455U2802**

[www.hammondmfg.com](http://www.hammondmfg.com)