



Sign



Storage



Chain

# VISO

Date : 24/09/19

## FICHE TECHNIQUE

### RXLO1100JARB – POTEAU A SANGLE AVEC ENROULEUR 10M

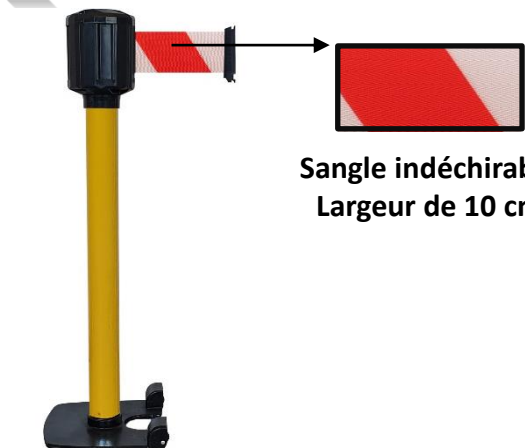

Sangle indéchirable  
Largeur de 10 cm

Gamme : WELCOME  
Code HSS : 7326909890

REF	Dimensions base (mm)	Hauteur (mm)	Ø Tube (mm)	POIDS (kg)
RXLO1100JARB	310x320	1110	80	11,10

- **Fabriqué en acier**
- **Coloris** : jaune avec sangle blanc et rouge

#### Caractéristiques :

- Sangle de 10M/ Largeur de 10 cm
- Base lourde à roulettes afin de déplacer facilement le poteau
- Sangle possède un système de freinage intégré, rembobinage automatique
- Sangle est indéchirable et le boîtier étanche
- Utilisation en extérieur
- Divers accessoires: panneau A4 (ref:RSA4PN), porte affiche A3 (ref:RSA3ROT) etc



#### Exemple d'accessoires

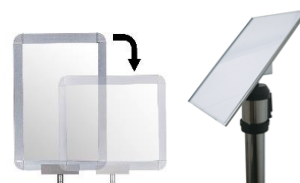



Sign



Storage



Chain

## TECHNICAL SHEET

### RXLO1100JARB - STEEL GUIDING POST STRAP 10M

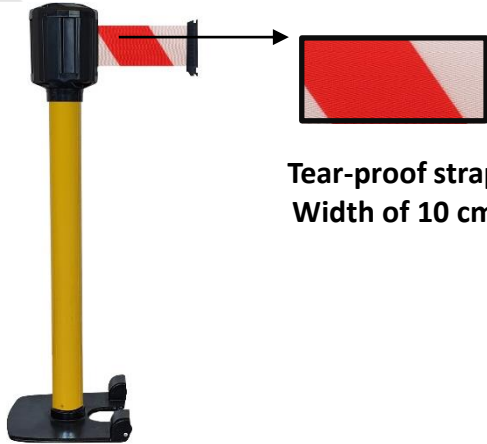

**Tear-proof strap  
Width of 10 cm**

Range : WELCOME  
Code HSS : 7326909890

REF	Ø Basa (mm)	Height (mm)	Ø Tube (mm)	weight (kg)
RXLO1100JARB	310x320	1110	80	11,10

- **Made of** steel
- **Color** : yellow with white and red strap

#### Specifications :

- 10M strap/ 10 cm width
- Heavy base with wheels to easily move the pole
- Strap has an integrated braking system, automatic rewind
- Strap is tear-proof and the case is waterproof
- Outdoor use
- Various accessories: A4 panel (ref:RSA4PN), A3 poster holder (ref:RSA3ROT) etc



310 mm

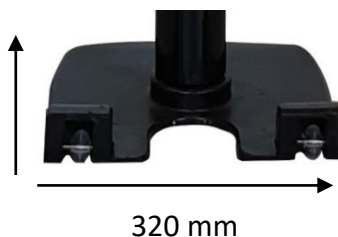

320 mm

#### Example of accessories

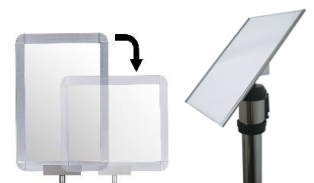



Sign



Storage



Chain

VISO

Date : 24/09/19

# FICHA TECNICA

## RXLO1100JARB - POSTE ACERO CORREA 10M



Correa antidesgarro  
Ancho de 10 cm

Gama : WELCOME  
Code HSS : 7326909890

REF	Ancho (mm)	Alto (mm)	Ø Tubo (mm)	Peso (kg)
RXLO1100JARB	310x320	1110	80	11,10

- **Fabricado en acero**
- **Color** : amarillo con correa roja et blanca

### Características :

- 10M correa/ 10 cm de ancho
- Base pesada con ruedas para mover fácilmente el mástil
- La correa tiene un sistema de frenado integrado, rebobinado automático
- La correa es a prueba de roturas y la funda es impermeable.
- Uso en exteriores
- Varios accesorios: panel A4 (ref:RSA4PN), soporte para pósters A3 (ref:RSA3ROT), etc.

### ejemplo de accesorios

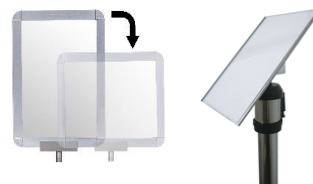



Sign



Storage



Chain

# VISO

Date : 02/07/2020



## TECHNISCHES BLATT

➔ RXLO1100JARB – GURTPFOSTEN MIT AUFROLLER 10M

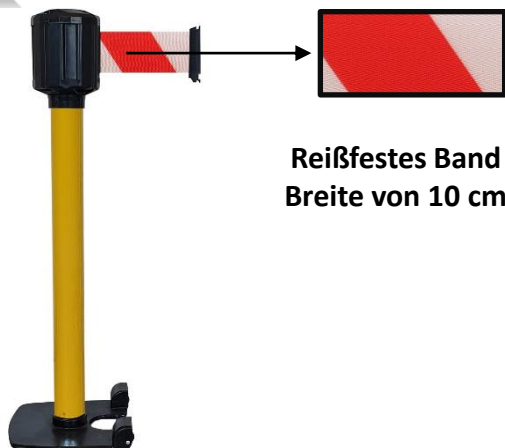

Reißfestes Band  
Breite von 10 cm

Reihe : WELCOME

Code HSS : 7326909890

REF	Grundabmessungen (mm)	Höhe (mm)	Poldurchmesser (mm)	Gewicht (kg)
RXLO1100JARB	310x320	1110	80	11,10

Hergestellt aus Stahl

Farbe : gelb mit rot-weiße Band

### Merkmale :

- 10M Gurtband / 10 cm Breite
- Schweres Untergestell mit Rollen zum einfachen Bewegen des Mastes
- Gurtband hat ein integriertes Bremssystem, automatisches Aufwickeln
- Das Band ist nicht reißbar und der Koffer ist wasserdicht.
- Außen Verwendung
- Verschiedene Zubehör: A4-Tafel (Ref: RSA4PN), A3-Plakathalter (Ref: RSA3ROT) usw.

### Beispiel für Zubehör

