



Paulmann

Safety Instructions

1, 2, 3, 4, 5, 6, 8, 11, 12, 15, 16,
19, 20, 21, 22, 24, 33, 34



Info

www.paulmann.com

Paulmann Licht GmbH
Quezinger Feld 2
31832 Springe
Germany

www.paulmann.com

Art.-Nr.: 955.26



(+MA326) PSU 05/20



1X

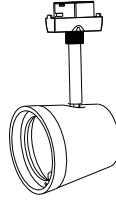

1X

Max.1x5W
GU10



1X

A

1.

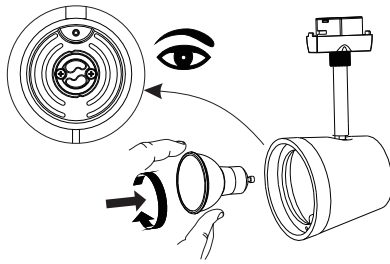

2.

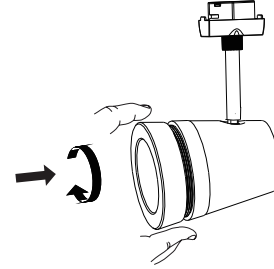

B

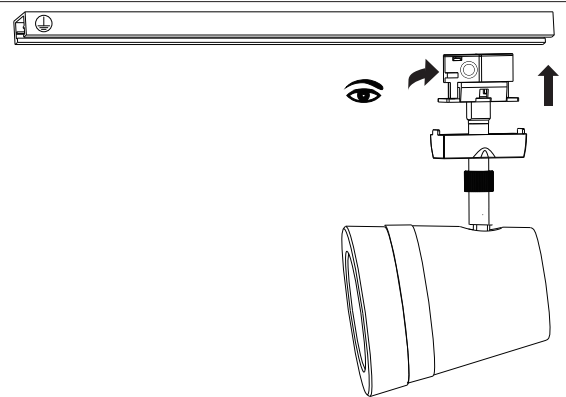
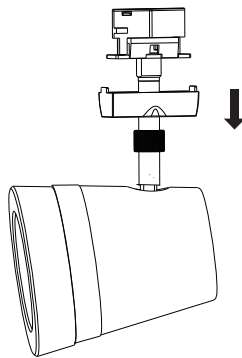
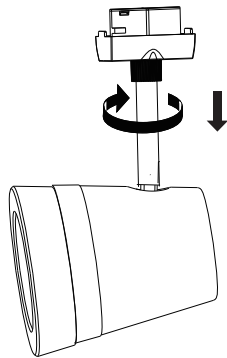

C

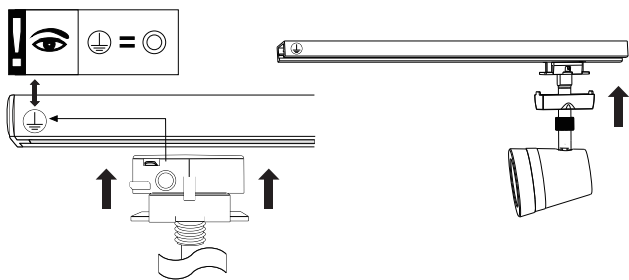

D

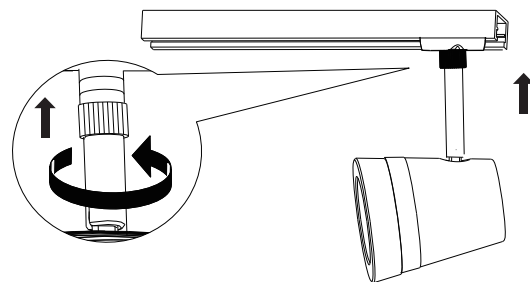

E

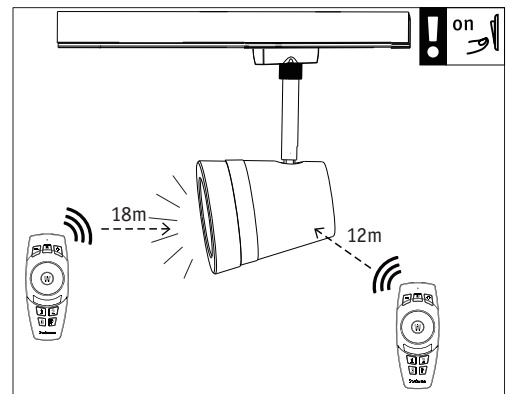
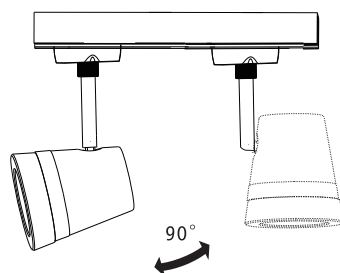
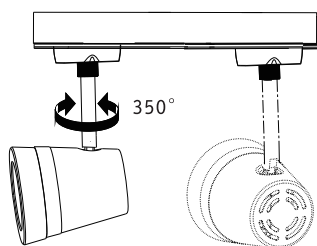

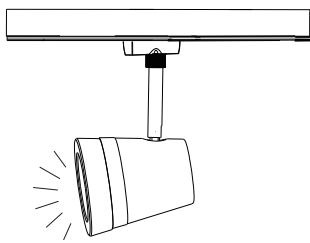
F

Reset

 5 x ON/OFF
 ON <2s> OFF >3s ON



Close 30cm

Connection Mode

1) >3S

2) Lamp flash 4x Succeed

Remote Control
 Paulmann
 Art.-Nr. 500.67

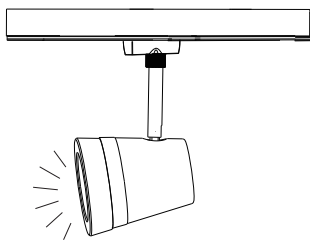
G

Reset

 5 x ON/OFF
 ON <2s> OFF >3s ON

Not incl.

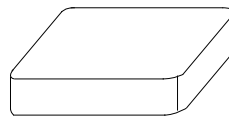
**Gateway**Paulmann
Art.-Nr. 500.66

APP



Zugelassen für den Betrieb in allen Ländern der EU / Approved for operating in all European countries

CE: Konform mit / in accordance with /
 conformement a 2014/30/EU, 2014/53/EU
<http://www.paulmann.com/de/de/b2b-haendler-log-in.html>

2,4 GHz -
 2,4835 GHz



doesn't apply for the geographical area within a radius of 20km from the centre on "Ny Alesund"

Hiermit erklärt Paulmann Licht, dass der Funkanlagentyp Art.-Nr: 955.26 der Richtlinie 2014/53/EU entspricht. Der vollständige Text der EU-Konformitätserklärung ist unter der folgenden Internetadresse verfügbar: www.paulmann.com/ce
 Funk-Frequenz 2,4 GHz-2,4835 GHz Abgestrahlte Energie 10mW