



Paulmann

Safety Instructions

1, 2, 3, 4, 5, 6, 8, 11, 12, 15, 16,
19, 20, 21, 22, 24, 33, 34



Info

www.paulmann.com

Paulmann Licht GmbH
Quezinger Feld 2
31832 Springe
Germany

www.paulmann.com

Art.-Nr.: 955.25



(+MA326) PSU 05/20



This product contains a light source of energy efficiency class G.



1x

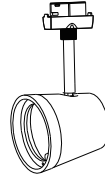

1x



1x

ZigBee Bulb
GU10
5,5W
RGBW

A

1.

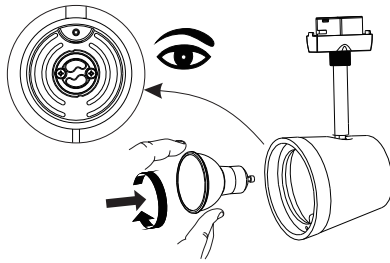

2.

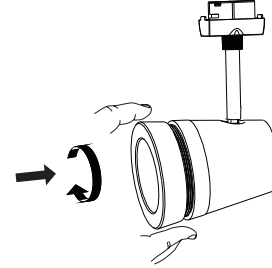

B

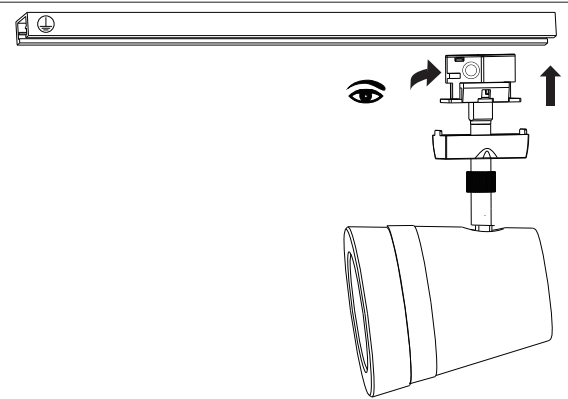
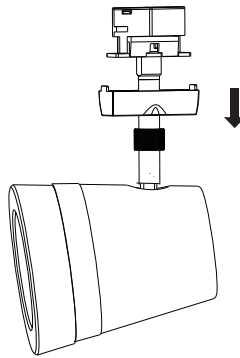
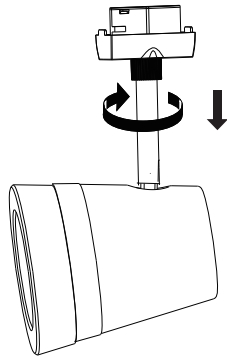

C

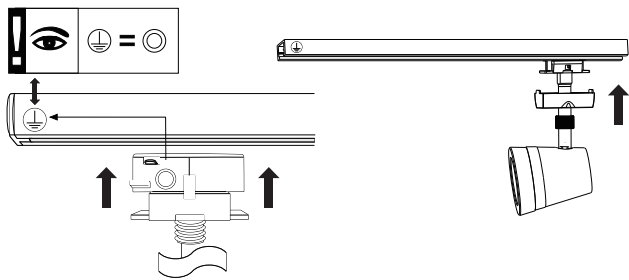

D

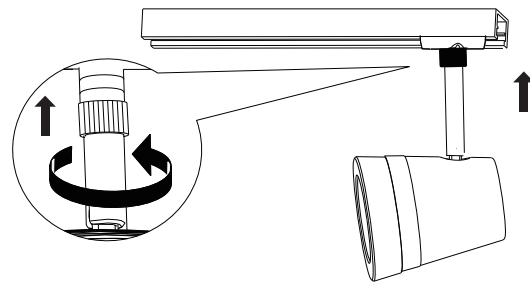

E

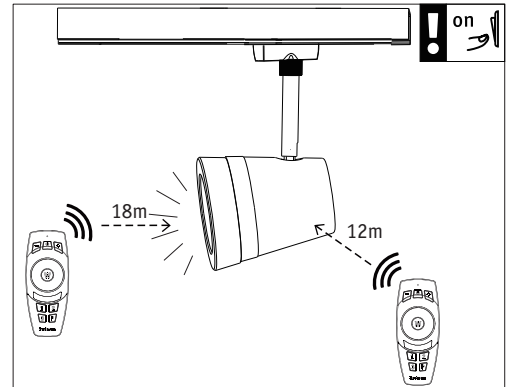
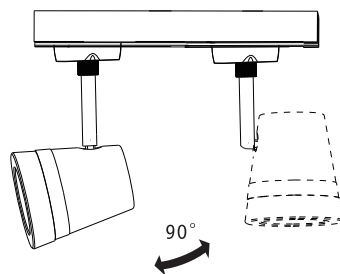
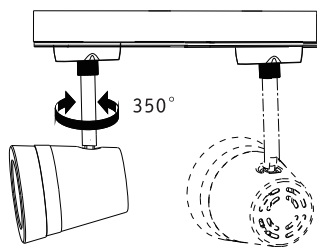

F

www.paulmann.com/symbols

Reset
ON
OFF

5 x ON/OFF
ON <2s, OFF >3s, ON

Close 30cm
Connection Mode

1) 1 2 >3S
3

2) Lamp flash 4x Succeed

Remote Control
Paulmann
Art.-Nr. 500.67

G

Reset
ON
OFF

5 x ON/OFF
ON <2s, OFF >3s, ON

Not incl. Gateway
Paulmann
Art.-Nr. 500.66

ON > 5s

APP

Zugelassen für den Betrieb in allen Ländern der EU / Approved for operating in all European countries

CE: Konform mit / in accordance with / conformement a 2014/30/EU, 2014/53/EU
<http://www.paulmann.com/de/de/b2b-haendler-log-in.html>

2,4 GHz - 2,4835 GHz

! NO

doesn't apply for the geographical area within a radius of 20km from the centre on "Ny Alesund"

Hiermit erklärt Paulmann Licht, dass der Funkanlagentyp Art.-Nr: 955.26 der Richtlinie 2014/53/EU entspricht. Der vollständige Text der EU-Konformitätserklärung ist unter der folgenden Internetadresse verfügbar: www.paulmann.com/ce
Funk-Frequenz 2,4 GHz-2,4835 GHz Abgestrahlte Energie 10mW