

NEMA11 STEPPER MOTOR

NEMA11-01

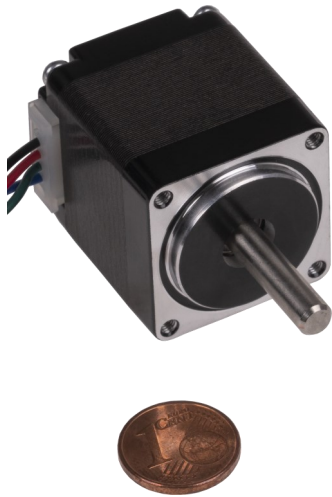

Our NEMA 11 series are very small high torque stepper motors that can reach speeds of up to 3000 rpm. These motors are used in model making and maker scene as well as in the industrial environment (e.g. positioning of optics, dosing pumps, interlocks, etc.).

MAIN FEATURES

Shaft	Ø 5 x 18 mm
Interface connection	4 wire
Dimensions	28 x 29 x 32 mm
Items delivered	NEMA11 stepper, connection cable

PERFORMANCE SPECIFICATIONS

Holding torque	55 mNm
Rated Voltage	5.0 V
Rated Current	0.42 A
Step Angle	1.8 ° ±5 %
No. of Phases	2
Phase Resistance	11.9 Ω
Phase inductivity	7.8 mH
Isolation resistance	100 MΩ min. @500 V DC
Isolation class	B (130 °C)
Rotational inertia	9 g·cm ²
Detent torque	5 mNm
Operating temperature	-10 °C - 50 °C

FURTHER DETAILS

Article No.	NEMA11-01
EAN:	4250236821719
Customs Tariff No.	8501109990

DRAWING

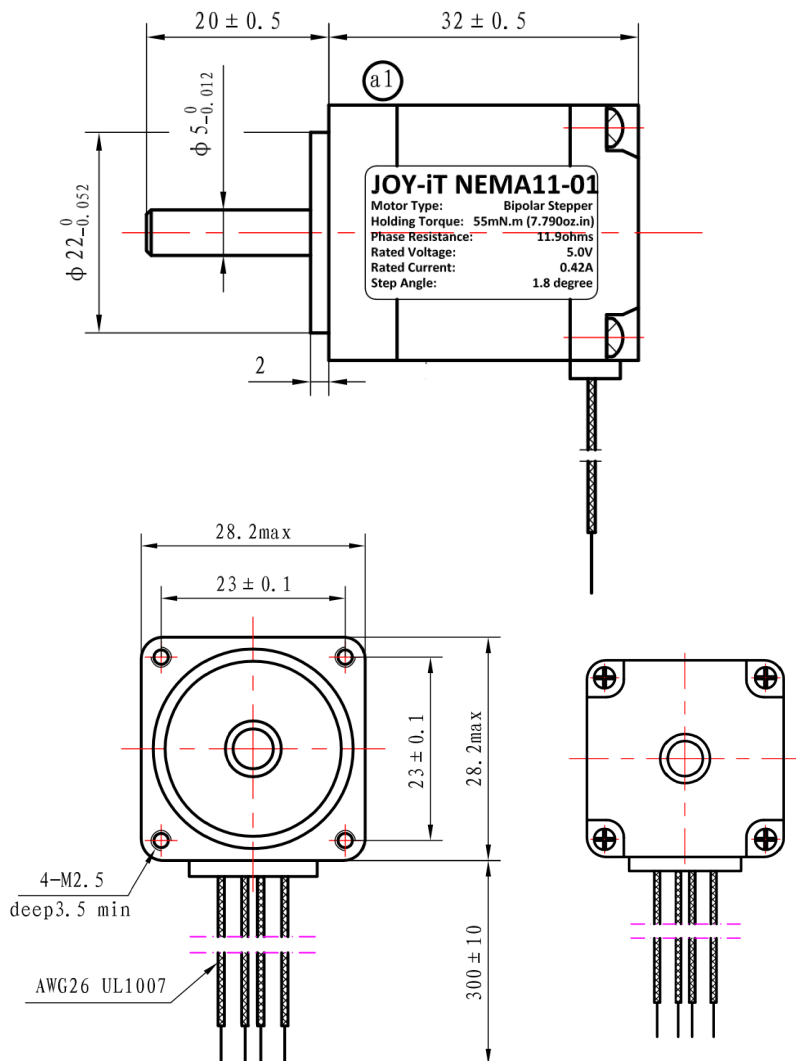

WIRING

