

HOW TO SOLDER? - HOE SOLDEREN ? - COMMENT SOUDER? - WIE LÖTEN? - ¿CÓMO SOLDAR?

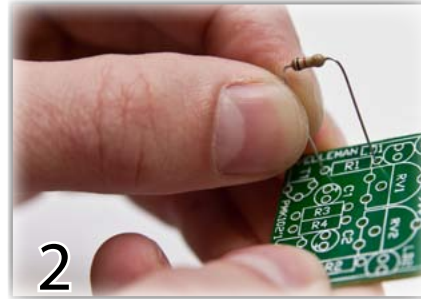

Wipe tip - Reinig de punt - Nettoyez la panne - Reinigen Sie die Spitze - Limpie la punta *



Insert part against PCB - Monteer het onderdeel tot tegen het printplaatje - Montez le composant contre le circuit imprimé - Montieren Sie das Bauteil bis gegen die Leiterplatte - Ponga la pieza junto al CI

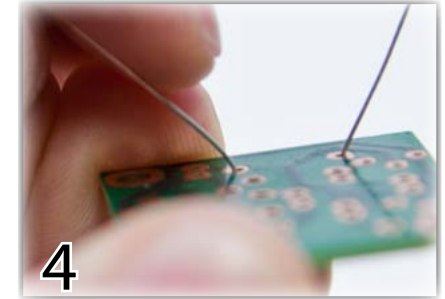
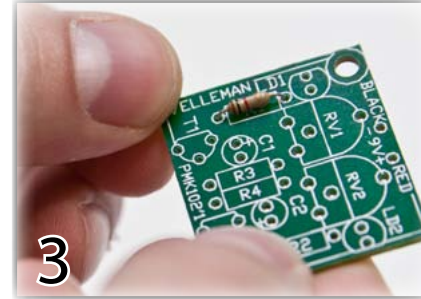

Bend leads - Plooi de aansluitdraden - Pliez les fils de connexion - Biegen Sie das Drahtende um - Pliegue los hilos

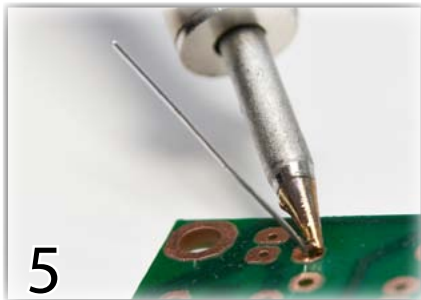

Heat part lead & PCB pad - Verwarm het uiteinde van de aansluitdraad en het printplaatje - Réchauffez l'extrémité du fil de connexion et le circuit imprimé - Erhitzen Sie den Anschlussdraht und die Lötstelle - Caliente una parte del hilo junto a la placa CI

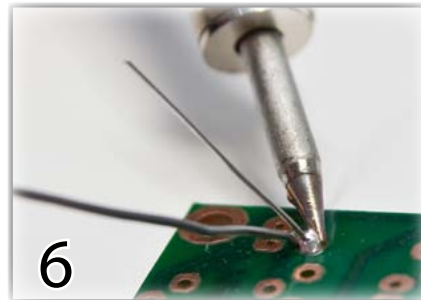

Apply solder - Breng soldeersel aan - Appliquez de la soudure - Führen Sie Lötzinn zu - Haga la soldadura

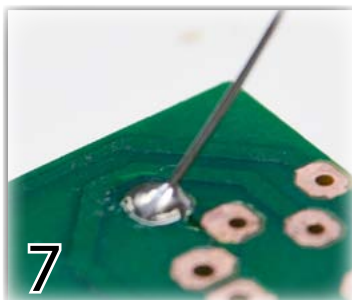

Correct joint - Correcte soldeerverbinding - Joint de soudure correct - Korrekte Lötverbindung - Soldado correcto

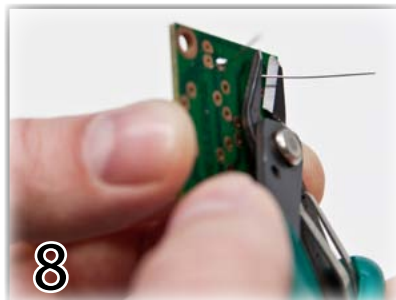

Cut close to PCB - Knip af tot tegen het printplaatje - Coupez jusqu'au bord du circuit imprimé - Zwicken Sie die Anschlussdrähte knapp über den Lötverbindungen ab - Corte cerca de la placa CI



Inspect - Controleer - Vérifiez - Überprüfen Sie - Compruebe la soldadura

Bad solderings - slechte solderingen - mauvaises soudures - Schlechte Lötstellen - Malas soldaduras



Too little solder - Te weinig soldeersel - Pas assez de soudure - Zu wenig Lot - Poco soldado

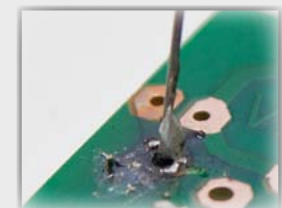

Too much heat - Te warm - Chaleur de soudure trop élevée - Zu warm - Demasiada temperatura

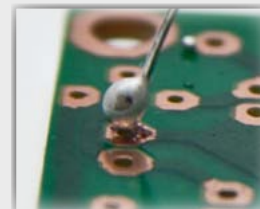

Bad contact - Slecht contact - Mauvais contact - Schlechter Kontakt - Mal contacto

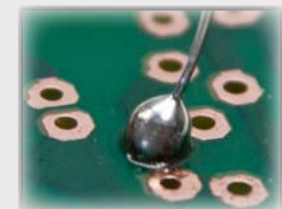

Too much solder - Te veel soldeersel - Trop de soudure - Zu viel Lot - Soldado en exceso

* not included - niet meegeleverd - non fournie - nicht mitgeliefert - no incluido

ELECTRONIC CHRISTMAS TREE - KERSTBOOM MET KNIPPERENDE LEDs - SAPIN DE NOËL AVEC LEDs CLIGNOTANTES - WEIHNACHTSBAUM MIT BLINKENDEN LEDs - ÁRBOL DE NAVIDAD CON LEDs INTERMITENTES - ALBERO DI NATALE ELETTRONICO - ÁRVORE DE NATAL A LED's

1 Resistor - Weerstand - Résistance - Widerstand - Resistencia - Motstand - Vastus - Resistenze

R1 ... R4: 1K2 (Brown, Red, Red) - (Bruin, Rood, Rood) - (Brun, Rouge, Rouge) - (Braun, Rot, Rot) - (Brun, Röd, Röd) - (Ruskea, Punainen, Punainen) - (Marrón, Rojo, Rojo) - (Castanho, Encarnado, Encarnado) - (Marrone, Rosso, Rosso)

R5, R6: 82K (Grey, Red, Orange) - (Grijs, Rood, Oranje) - (Gris, Rouge, Oranje) - (Grau, Rot, Orange) - (Grå, Röd, Orange) - (Harmaa, Punainen, Oranssi) - (Gris, Rojo, Naranjado) - (Cinzento, Encarnado, Laranja) - (Grigio, Rosso, Aranciato)

R7, R8: 100K (Brown, Black, Yellow) - (Bruin, zwart, Geel) - (Brun, noir, Jaune) - (Braun, Schwarz, Gelb) - (Brun, Svar, Gul) - (Ruskea, Musta, Keltainen) - (Marrón, Negro, Amarillo) - (Castanho, Preto, Amarelo) - (Marrone, Nero, Giallo)

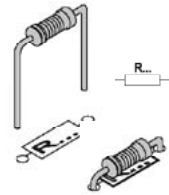

2 LEDs

• LD1 ... LD13: 3 mm

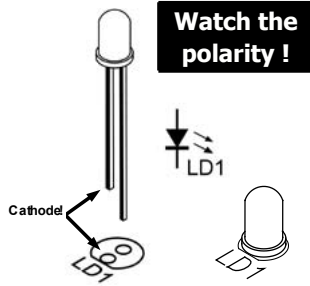

3 Transistor

• T1 ... T4: BC547

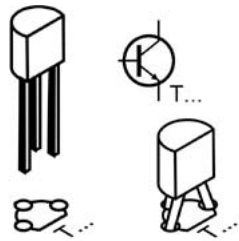

4 Electrolytic capacitor

• C1 ... C4: 10µF

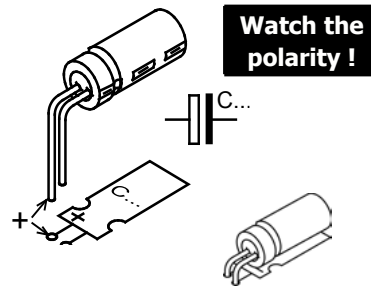

5 Battery holder

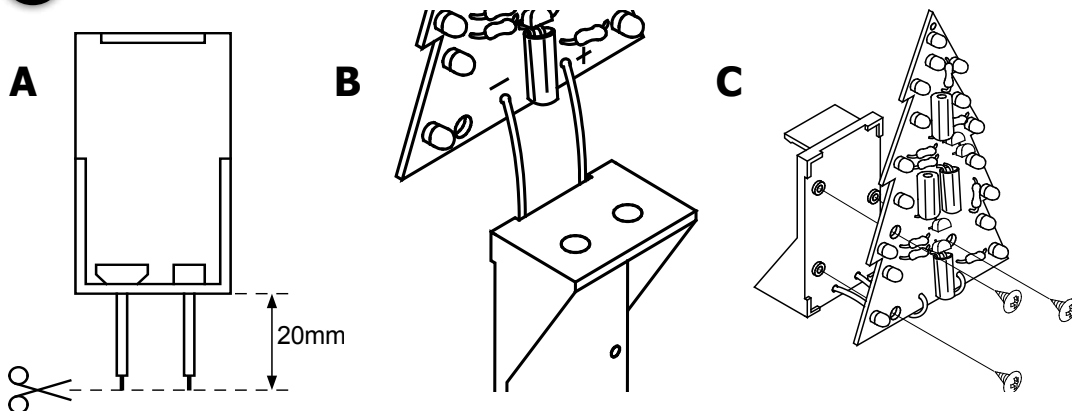

ELECTRONIC CANDLE - ELEKTRONISCH THEELICHTJE - BOUGIE CHAUFFE-PLAT ÉLECTRONIQUE - ELEKTRONISCHES TEELICHT - VELITA ELECTRÓNICA - CANDELA TEALIGHT ELETTRONICA - VELA CINTILANTE

1 Resistor - Weerstand - Résistance - Widerstand - Resistencia - Motstand - Vastus - Resistenze

Lower side - Componentenzijde
- Inférieur soie - Niedriger seide
- Inferior seda

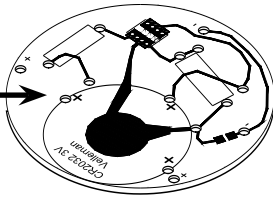

R1: 100

(Brown, Black, Brown) - (Bruin, zwart, Brown) - (Brun, noir, Brun) - (Braun, Schwarz, Braun) - (Brun, Svart, Brun) - (Ruskea, Musta, Ruskea) - (Marrón, Negro, Marrón) - (Castanho, Preto, Castanho) - (Marrone, Nero, Marrone)

R2: 100K

(Brown, Black, Yellow) - (Bruin, zwart, Geel) - (Brun, noir, Jaune) - (Braun, Schwarz, Gelb) - (Brun, Svart, Gul) - (Ruskea, Musta, Keltainen) - (Marrón, Negro, Amarillo) - (Castanho, Preto, Amarelo) - (Marrone, Nero, Giallo)

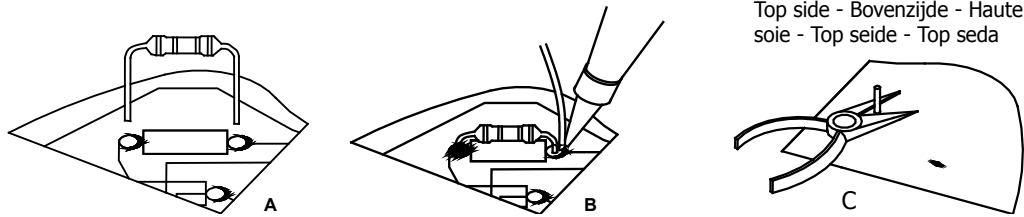
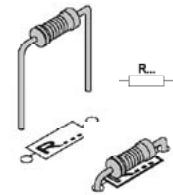

Top side - Bovenzijde - Haute soie - Top seide - Top seda

2 Battery holder

solder drop - soldeer druppel
- goutte de soudure - Lot
Tropfen - gota de soldadura

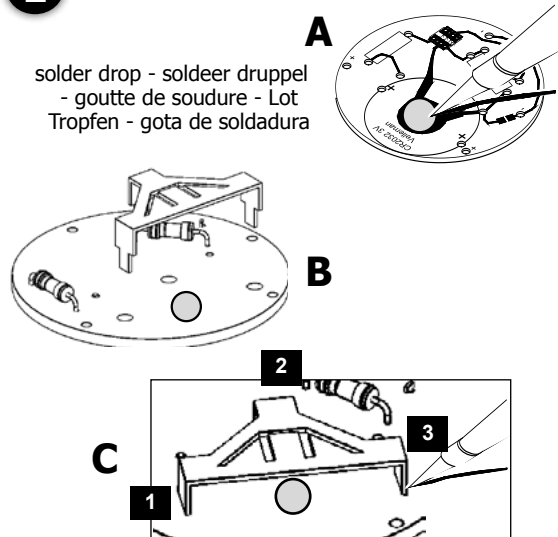

3 IC

• IC1: VMK167
(programmed PIC10F200-I/PG)

Watch the notch !
Attention à l'encoche !

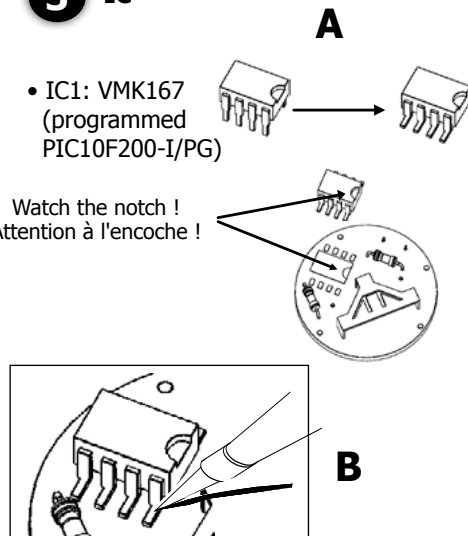

4 PCB TABS

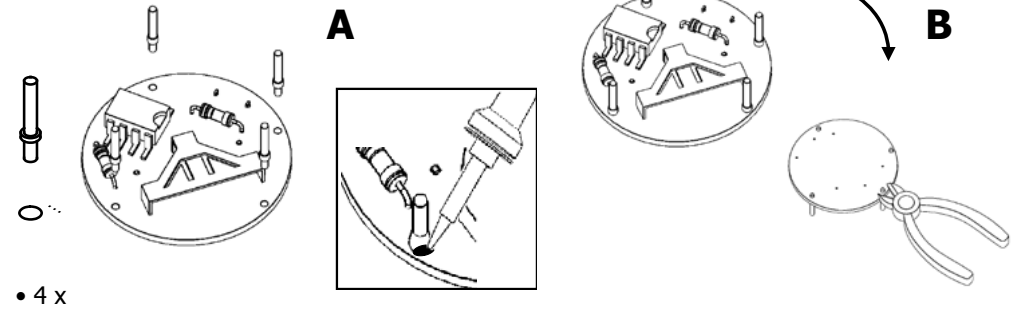

• 4 x

5 BUTTON

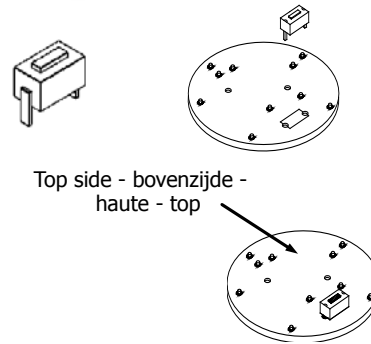

Top side - bovenzijde - haute - top

6 LED

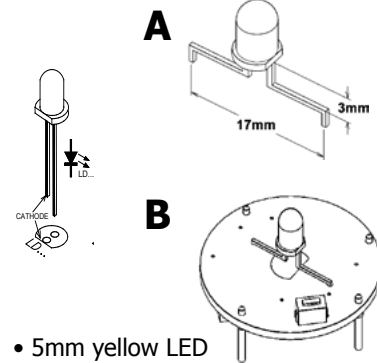

• 5mm yellow LED

7 LED

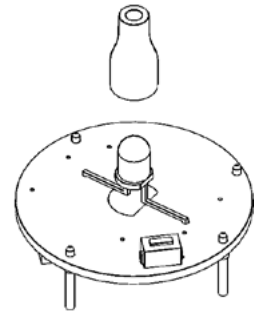

8 BATTERY

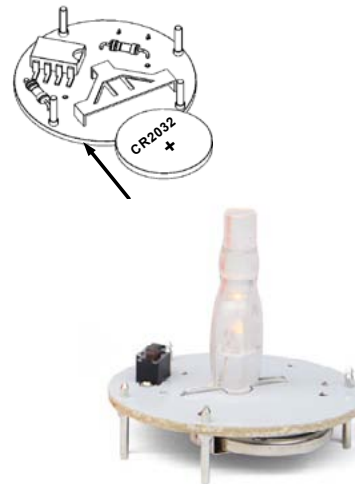

9 OPERATION

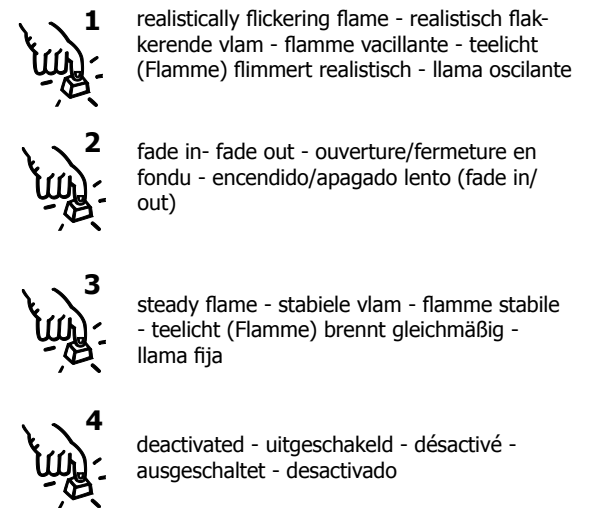

1 realistically flickering flame - realistisch flakkerende vlam - flamme vacillante - teelicht (Flamme) flimmert realistisch - llama oscilante

2 fade in- fade out - ouverture/fermeture en fondu - encendido/apagado lento (fade in/out)

3 steady flame - stabiele vlam - flamme stable - teelicht (Flamme) brandt gelijkmatig - llama fija

4 deactivated - uitgeschakeld - désactivé - ausgeschaltet - desactivado