



craftbot
FLOW GENERATION

USER MANUAL
- SINGLE HEAD PRINTERS



TABLE OF CONTENTS

- 1. INTRODUCTION 3
- 1.1. Craftbot Flow / Flow XL printer components 4
- 1.2. Specifications 5
- 2. SAFETY 6
- 2.1. Warnings 6
- 3. UNPACK AND ASSEMBLY. 7
- 3.1. Unpacking the printer 7
- 3.2. Accessories 7
- 3.3. Assembling the Craftbot Printer 8
- 4. First steps 9
- 4.1. Switching on the Appliance 9
- 4.2. Printer wizard 9
- 5. OPERATING THE PRINTER 10
- 5.1. Menu map 10
- 5.2. Heating up the printer 11
- 5.3. Loading the filament 11
- 5.4. Unloading the filament 12
- 5.5. Changing filaments 12
- 5.6. Start a print 13
- 5.7. In-print adjustments / pause menu 13
- 5.8. File management 14
- 5.9. Calibration. 15
- 5.9.1. Assisted bed calibration. 15
- 5.9.2. Mesh bed leveling. 15
- 5.9.3. Extruder (FMS) calibration 16
- 5.9.4. Offset calibration 16
- 5.10. Removing objects from the build plate 16
- 5.11. Firmware update. 17
- 6. CRAFTWARE 18
- 6.1. Installing CraftWare. 18
- 6.2. Using CraftWare to generate .gcode files. 18
- 7. USING THE WEB INTERFACE. 19
- 7.1. Login 19
- 7.2. Main menu 19
- 7.3. Uploading files through the WEB interface. 20
- 7.4. Printing objects through the WEB interface 20
- 7.5. Watching the camera remotely 21
- 8. CLEANING AND MAINTENANCE. 22
- 8.1. Cleaning 22
- 8.2. Lubricating 23
- 8.3. Removing clogging of the extruder. 24
- 8.4. Removing the nozzle 24
- 8.5. Replace the Fan set. 25
- 8.6. Relocation of the Fan assembly to the extruder assembly 25
- 8.7. Applying a new Kapton sheet to your build plate. 26
- 9. GUARANTEE AND LIMITATION OF LIABILITY. 26

1. INTRODUCTION

Congratulations on your purchase of the Craftbot Flow Generation printer and welcome to the world of 3D crafting! At CraftUnique we believe that 3D printing opens a new window to enhance creativity. It offers outstanding crafting experience even without prior programming or 3D printing experience.

How does the printer work? The Craftbot 3D printer makes solid, three-dimensional objects out of melted plastic filament. First you will have to have your objects with the help of a 3D design program. Then you will need to use the CraftWare program (downloadable from www.craftunique.com/craftware) to transform your 3D design files into printing instructions for the Craftbot 3D printer. Transfer your files to Your Craftbot 3D printer via USB drive or Wi-Fi. The Craftbot 3D printer will melt plastic filaments and squeeze it out onto the building plate in thin lines to print your object layer by layer.

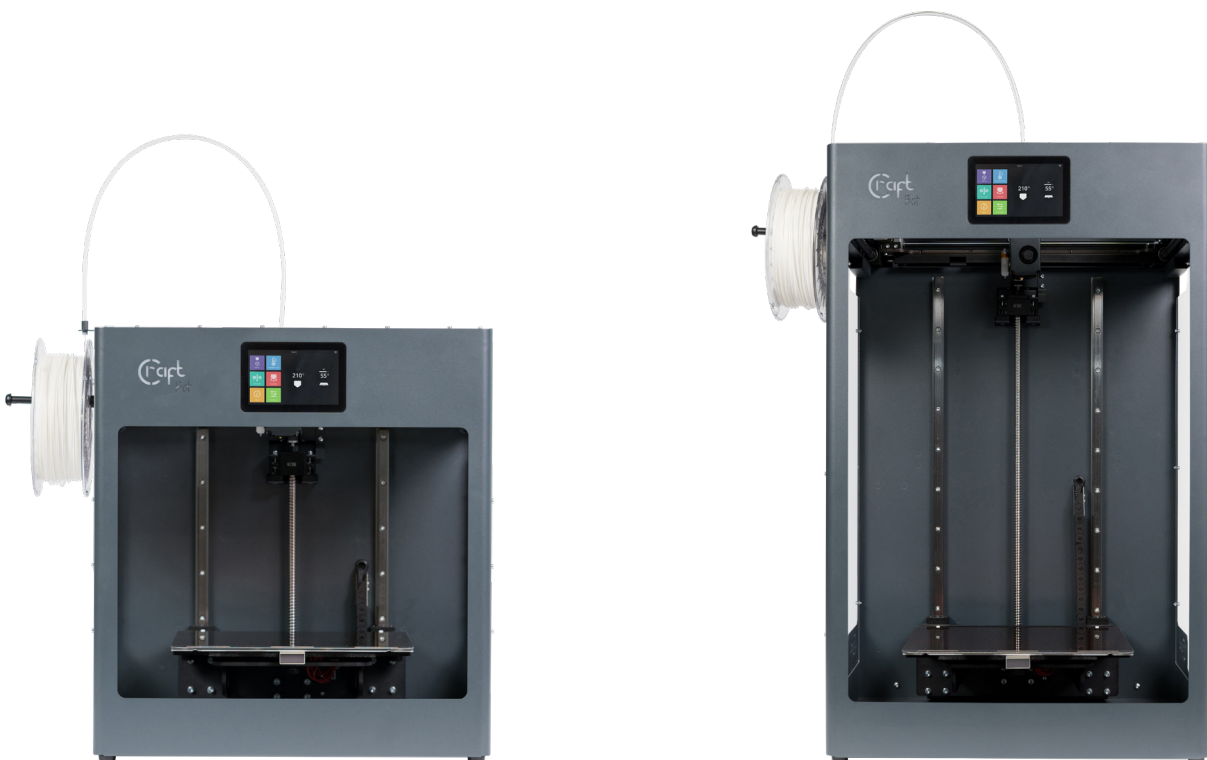

1.1. Craftbot Flow / Flow XL printer components

1. Filament guide tube
2. Touchscreen LCD display
3. Hotend
4. Build plate
5. Z axis rod

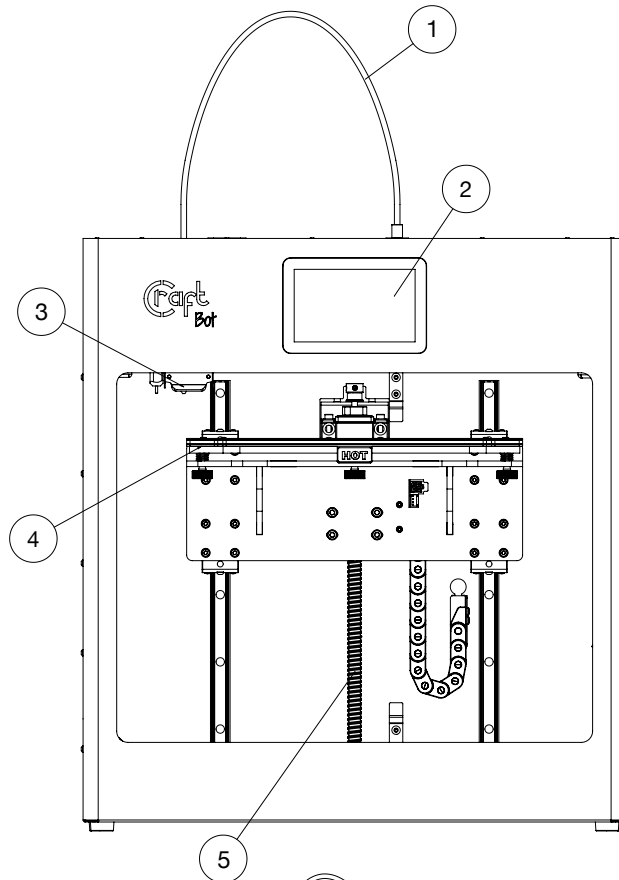

6. USB connector for flash drive
7. Extruder
8. Filament guide tube holder
9. Filament spool holder
10. Filament spool
11. ON / OFF switch
12. AC power cable
13. LAN connection
14. Reset button

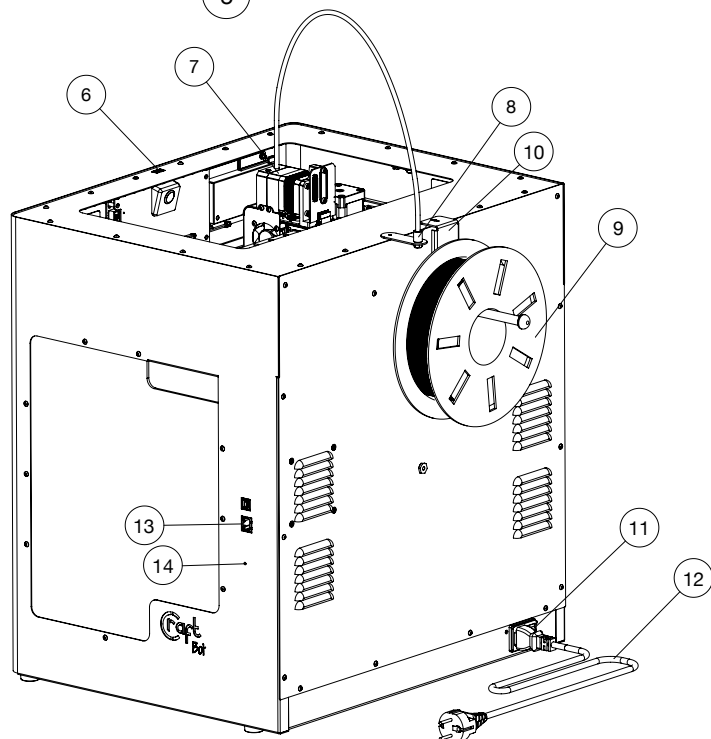

The model displayed is the Craftbot Flow printer.
The difference between the two models is the frame height.
See Specifications for the different dimensions.

1.2. Specifications

PRINTING PROPERTIES	FLOW	FLOW XL
Printing technology	Fused Filament Fabrication (FFF)	
Printing heads	All metal hotend with Filament Monitoring system (FMS)	
Build volume	X: 300mm x Y: 200mm x Z: 250mm	X: 300mm x Y: 200mm x Z: 500mm
Theoretical precision	X,Y: 4 microns, Z: 2 microns	
Layer resolution	For 0.4mm nozzle recommended 50-300 microns	
Travel speed	Up to 160mm/s	
Print speed	Up to 160mm/s	
Build speed	0.4mm nozzle: up to 19.2 mm ³ /sec	
Build plate	Heatable, magnetic build plate, with removable spring steel build surface	
Build plate temperature	40 - 110°C	
Filament diameter	1.75mm	
Supported materials	PLA, ABS, HIPS, PET-g, Nylon, TPU, PVA, Moldlay (wax like), up to 300°C	
Nozzle diameter	Default: 0.4mm, supplied: 0.25mm, 0.4mm, 0.6mm, 0.8mm	
Nozzle temperature	40 - 300°C	
Hotend	All metal hotend	
Extruder	Dual drive extruder, ratio: 5,06:1	
CALIBRATION		
Build plate calibration	Assisted bed calibration	
XY calibration	Fully automatic, no intervention required	
POWER REQUIREMENTS		
Voltage range	90-264V	
Frequency range	47-63Hz	
Power factor	PF>0.95/230VAC	
Efficiency (Typ.)	94,5%	
Power MAX	500W, 5.5A	
OTHERS		
Display	5 inch, active matrix color display 800 x 480 pixels	
Connectivity	Wi-Fi, LAN, USB, Flash drive	
Internal storage	4GB, non removable	
Wi-Fi	IEEE 802.11b/g compatible	
Monitoring	IOT Web interface, Live camera	
Camera resolution	5MP, Stream output 800 x 600	
Operating noise level	50dBA	
Optional accessories	Glass door, ventilated PET-g dome	
PHYSICAL		
Frame	All steel frame	
Frame dimensions	X: 485mm, Y: 390mm, Z: 540mm	X: 635mm, Y: 450mm, Z: 775mm
Equipped with dome	X: 485mm, Y: 390mm, Z: 700mm	X: 635mm, Y: 450mm, Z: 950mm
Weight	32 kg	38 kg
Shipping weight	46 kg	52 kg
Available colors	White, Grey	
OPERATING CONDITIONS		
Operating ambient temperature	10-35 °C	
Humidity	10-90% RH, non-condensing	
Storage temperature	0-35°C	
SOFTWARE		
Supplied software	CraftWare, our free slicer software	
Supported OS	Windows, macOS, Linux	
Supported file types	STL, OBJ, 3mf	

2. SAFETY

Read this user manual carefully before you use the appliance, then save it for future reference. All information in this user manual is subject to change at any time without notice and is provided for convenience purposes only. CraftUnique, reserves the right to modify or revise this user manual in its sole discretion and at any time. By using the manual, you agree to be bound by any modification and/or revisions. For up-to-date information contact the CraftUnique Service Support team (support@craftbot.com).

2.1. Warnings

Check if the voltage indicated on the back of the appliance corresponds to the local mains voltage before you connect the appliance.

- Do not immerse cord, plug or main body in water or any other liquid. This may cause electrical shock.
- Do not use the appliance if the plug, the mains cord or the appliance itself is damaged or not operating properly.
- If the mains cord is damaged, you must have it replaced in order to avoid hazard.
- Only connect the appliance to grounded wall sockets.
- Keep the mains cord away from hot surfaces.
- Do not let the mains cord hang over the edge of the table or worktop on which the appliance stands.
- Keep the appliance and its cord out of the reach of children.
- This appliance can be used by children aged from 8 years and above; and by persons with reduced physical, sensory or mental capabilities or a lack of experience and knowledge. These persons should be under supervision and given adequate instruction concerning the use of the appliance in a safe way, understanding the hazards involved. Cleaning and user maintenance shall not be made by children.
- Children can receive great educational benefits from designing 3D objects, but the printing process should not be done by small children.
- Do not touch moving parts or heated elements, it can cause injuries.
- Never reach inside the machine when turned on. Different parts of the machine (mainly the extruder and heated build plate) operate at very high temperatures and can cause severe burns.
- Never leave the Craftbot 3D printer unattended while it is plugged in, and is in operation.
- Make sure that the power supply is switched off and that the power cord is disconnected before servicing. Allow at least 5 minutes for the device to cool down after unplugging it before reaching inside to service.
- Always turn off the printer and disconnect from the computer when it is not being used.
- Make sure to level the build plate properly before use.
- Make sure not to force anything, whether it be during unpacking, setup, operation or service.
- Service and oil the suggested parts as often as recommended. Only use only substances recommended by CraftUnique.
- The Craftbot 3D printer melts plastic during printing. Plastic odors/gases are emitted during this operation. Make sure to set up the Craftbot 3D printer in a well-ventilated area.
- Do not change or adjust anything on the printer, unless the modification is authorized by the manufacturer.
- Do not store items in the printer.

3. UNPACK AND ASSEMBLY

3.1. Unpacking the printer

1. Place the Craftbot box on the ground on a level surface. Make sure that there is a lot of open space around you.
2. Open the box with care, not to damage the contents if using a blade. Be careful and watch out for the printer as well.
3. Remove the protective foam insert. You will find the Quick Starter Guide located within the top protective foam insert.
4. There is a Box inserted, which contains the accessories (including a flash drive with a copy of the Craftbot user manual). Remove the Box with care as it supports the extruder during shipping.
5. Now you will find the Craftbot 3D printer itself completely enclosed in a protective plastic bag. Open the plastic covering.
6. Firmly grasp the frame of the Craftbot. Consider its weight. Request physical help if needed.
7. Make sure not to touch the extruder or the electronic panel inside the appliance!
8. Place the Craftbot 3D printer on a stable and level surface with sufficient space surrounding around it.

3.2. Accessories

Below you can see contents of the box. First of all, check the list to make sure nothing is missing!

- | | |
|---|-----------------------|
| 1. AC Power cable according to your region (1x) | 6. Hex wrenches (5x) |
| 2. Filament guide tube holder (1x) | 7. Flash drive (1x) |
| 3. Filament guide tube (1x) | 8. USB A-B cable (1x) |
| 4. Filament spool holder (1x) | 9. Nozzle kit (1x) |
| 5. Filament spool (1x) | 10. Cleaning kit (1x) |

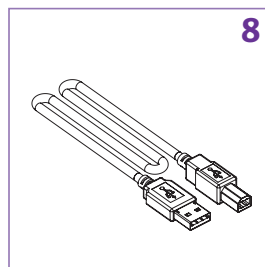
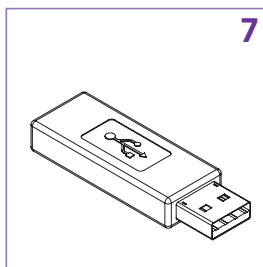
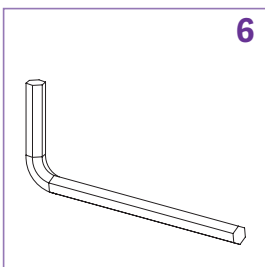
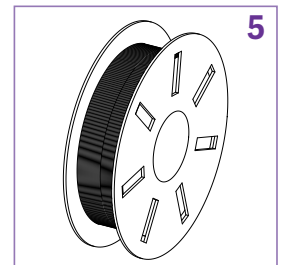
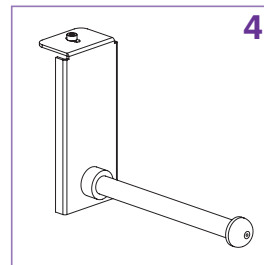
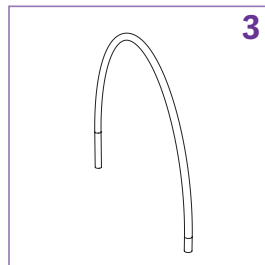
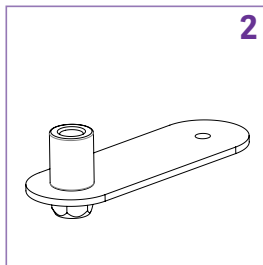
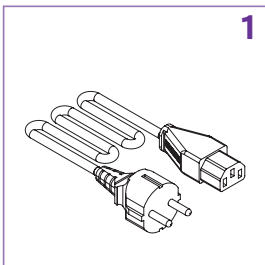

3.3. Assembling the Craftbot Printer

- Install the filament guide tube holder
 - Select the desired position for filament guide holder. Choose its position so that the filament spool holder fits beside it.
- Install the filament guide tube
 - Locate the filament guide tube.
 - Insert one end of the filament guide tube into the filament guide tube holder on top of the Craftbot appliance.
 - Push the other end into the hole on the top of the extruder.
- Install the filament spool holder
 - Locate the filament spool holder.
 - Using a hex wrench, install the filament spool holder next to the filament guide tube holder.
- Mount the filament spool
 - Fit the filament spool onto the filament spool holder so that the lead end keeps its course when the filament is fed into the filament guide tube holder.
- Attach the power cord
 - Ensure that the power switch on the Craftbot is set to the OFF position.
 - Find and then insert the AC power cord into the power input on the back of the Craftbot.
 - Plug the power cord into a wall socket.

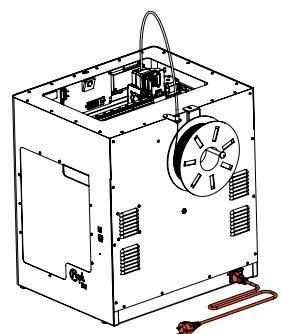
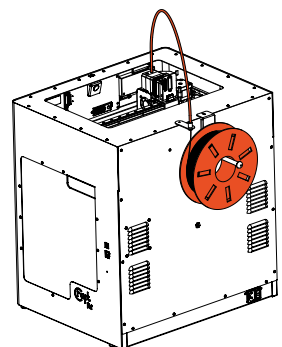
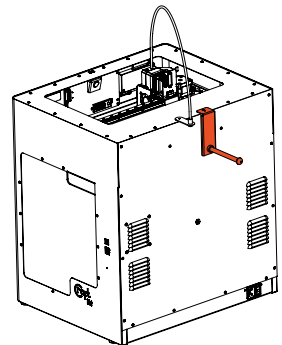
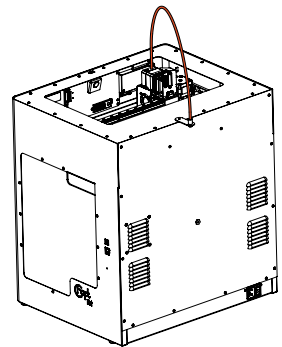
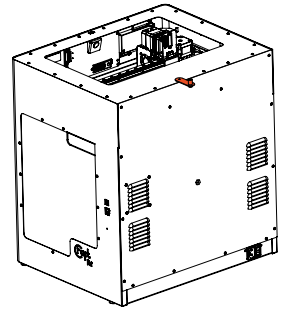

4. FIRST STEPS

4.1. Switching on the Appliance

Switch on Craftbot by the ON / OFF button located on the back part of the appliance. The LCD panel on the front will light up.

Navigation on the touch screen is possible by touching icons.

On the main screen, you can preheat the head to a preset temperature by pressing the print head or build-plate icon.

In the top bar we can see:

- HMI version number
- The IP address if the printer is connected to a network
- The Wi-Fi icon when the printer is connected to a Wi-Fi network
- The flash drive icon if there is a flash drive in the machine

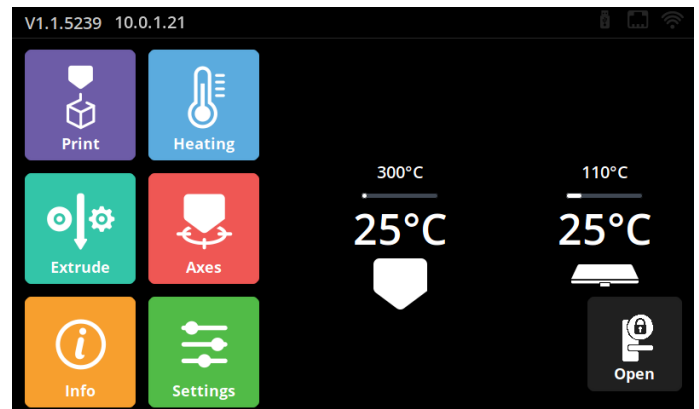

4.2. Printer wizard

The first time you use the printer, the printer wizard will appear. The wizard will walk you through the steps needed to get the most out of your printer:

- Language
- Time zone
- Firmware update
- Network (LAN/Wi-Fi)
- Calibration

If you are unsure, you can always run the printer wizard from the setting menu.

5. OPERATING THE PRINTER

5.1. Menu map

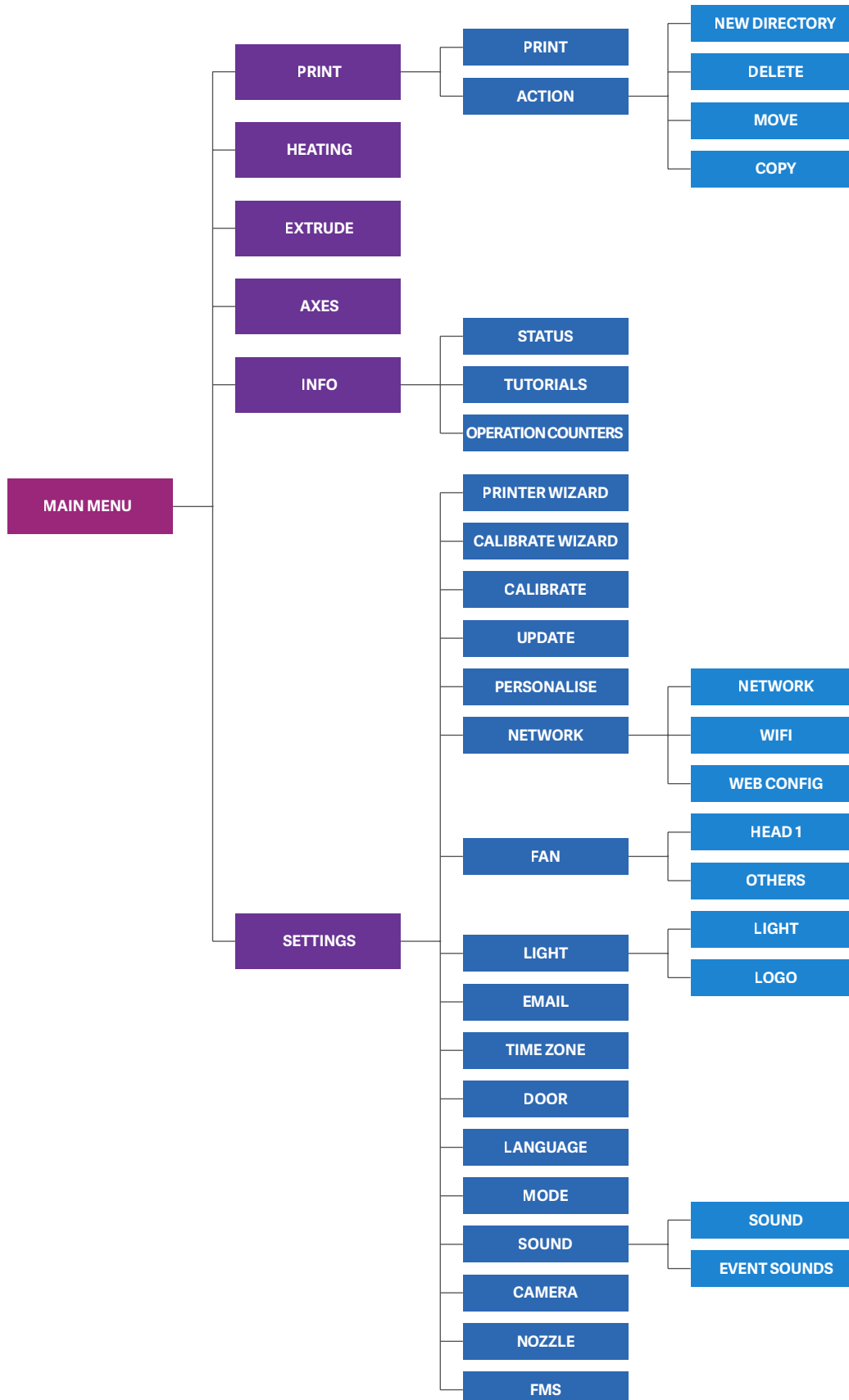

5.2. Heating up the printer

Warming up, loading or removing filaments the head is essential for printing. From the main menu screen, touch the element to be heated (head, build plate icons) which will warm up to a predefined temperature.

If you want to change the heating values, follow the instructions below.

In the main menu, press the Heating  icon.

In the upper part of the new window you can select the desired material (ABS, PLA, PETG...) from the drop-down list.

If you want to print material with different temperature values, you can change the values by selecting USER1 or USER2. Adjust the sliders or the + and - marks to set the desired values for the head or build plate.

In the Heating menu you can switch on or off the heating by touching the element (head, build plate) icons.

Allowed temperatures:

- Head temperature: 40-300 °C
- Build plate temperature range: 40-110 °C

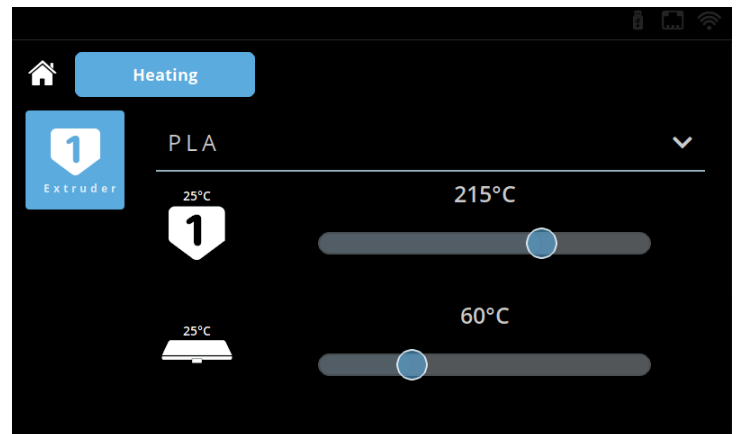

5.3. Loading the filament

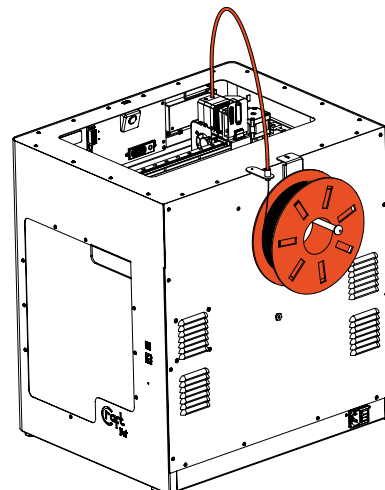
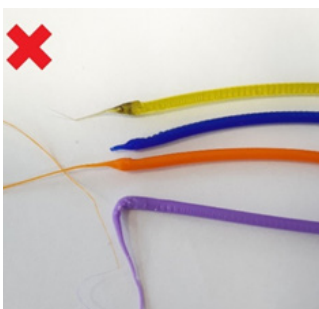

Heat up the extruder where you want to insert the filament.

- Take the end of the filament out of the securing hole on the Filament spool.
- Cut and the end of the filament so the filament is straight and has no damages bends kinks or melted parts.
- Remove the filament guide tube from the insert hole on the top of the extruder.
- Insert the end of the filament from the spool UP into the filament guide tube holder, then into the filament guide tube. Pass the filament through the tube until it protrudes on the extruder side of the tube.
- Push the filament into the top of extruder hole.



Select the Extrude  menu on the Home screen.

Before extruding, make sure the head is next to the build plate, not pressed into the plate or directly above.

- To extrude filament from the print head, use the down arrow  on the touch screen.
- Press and hold the button to keep the filament extruded of the head.
- Automatic filament feed can also be performed by pressing the Load  button on the bottom bar. By pressing the button once, the head automatically extrude some filament.
- Filament loading is successful when the melted filament flows out of nozzle evenly and vertically.



Watch out! The freshly spilled molten filament is hot. Avoid contact with spilled filaments or other flammable materials in the near.

5.4. Unloading the filament

Never remove the filament from the extruder if the extruder is cold!

Always preheat the extruder before removing or changing filaments. Removing the filament from a cold extruder might damage it!

You don't have to remove the filament between prints.

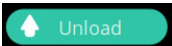
- Heat the extruder as described above.
- Make sure the head is next to the build plate, not pressed into the plate or directly above.
- When the extruder reaches the temperature required for the filament, press the down  arrow , then the up  arrow.
- Automatic filament unload can also be performed by pressing the Unload  button.
- When the gears start to retract the filament, you can safely pull out the rest of the filament from the guide tube and connect the end of the filament to the spool for safe keeping. Now you are ready to load a new filament.

5.5. Changing filaments

- When changing filaments, note that different filaments, such as PLA, ABS, and PET, have different temperature characteristics.
- If you want to replace a material with a higher temperature (eg. ABS, PETG) with a material with a lower temperature (PLA), it is need to heat the head to a higher temperature so that the previous material can leave the head completely before the other filament in its place.
- When changing colors, always push more material out of the head, ensuring that the replaced color is completely removed from the head. During printing, it may be uncomfortable to notice that the print color is still blending with the previous color, for example, changing from red filament to white.

5.6. Start a print

You can print the previously saved .gcode files in more ways: Either from the printer 4GB internal storage, or from USB flash drive. Save the gcode file created by the CraftWare slicer program onto USB flash drive or to the printer internal storage directly. See section 7.

- Select the Print menu  on the main screen.
- Please locate the file what you like to print. The files on the flash drive can be located under the "pendrive" folder, the internal storage is under the "local" folder.
- Move the list up or down to locate the gcode of the item you want to print and select it. You can only select one gcode for printing, if multiple items are selected, printing cannot be started!
- Press the Start button in the right corner of the screen.
- The machine warms the print head and the build plate to the values specified in gcode.
- Printing starts when the machine reaches the required operating temperature.
- Please make sure that you have enough filament for the selected project. The quantity is pre-calculated by CraftWare.
- After the object has been printed, remove the build plate. Printed object can be removed easily, just bend the flexible build plate. **Please note, if the object is still warm, it may bend when removed.** To avoid this, please allow some time to cool.

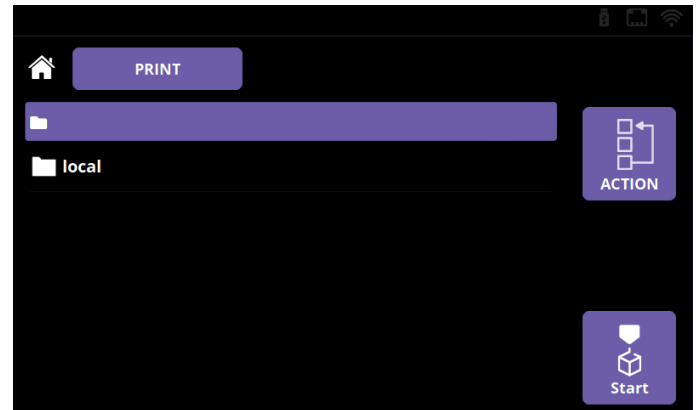

5.7. In-print adjustments / pause menu

During printing, sometimes it can be essential to modify the printing parameters on the fly. Also this menu pops up, when the printer gets a pause command from the gcode or from the screen. In Pause menu users can change filament, continue printing or terminate the printing operation. Pressing the resume button will continue the printing. For filament change use the Extrude / Reverse functions, or the preprogrammed Load / Unload options.

The in-print adjustments overrule the setting is the gcode.

You can change the print settings during printing by pressing the Settings  button on the right icon bar.

The following parameters can be altered:

- Print temperatures
- Fan speeds
- Print speed and material flow
- Lighting
- Encoder
- Camera

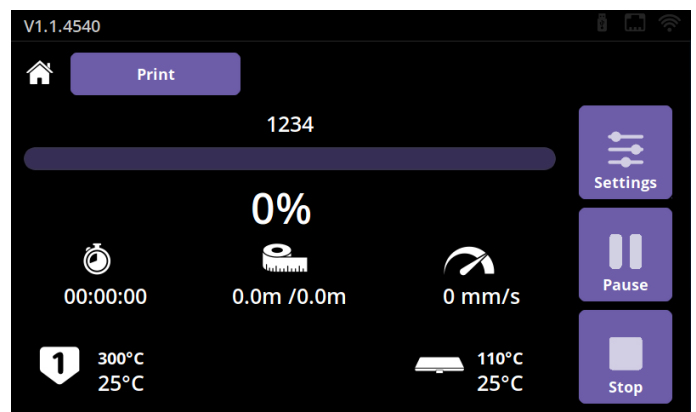

Temperature

Head and build plate temperature can be adjusted separately.

Adjust the temperature of the head and the build plate touching the slider and the + and - buttons.

You can lock the previously set values if needed.

Speed

Print speed and extrusion volume can be modified in percentage ratio to the original.

Use the reset button to change back the values of the gcode.

Fan speeds also can be altered, if necessary.

Light

Lights within the appliance and display back-lighting can be changed.

Extrude

For filament change use the Extrude / Reverse functions, or the preprogrammed Load / Unload options.

Encoder

You can enable / disable the FMS functionality and email notification.

Camera

You can enable the time-lapse function, if the printing already started. Here you can choose whether you want to take a picture every 1, 5 or 10 seconds. This parameter does not disables the remote camera access.

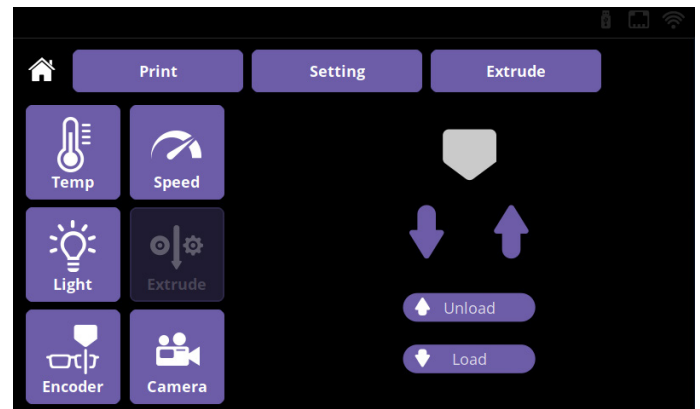
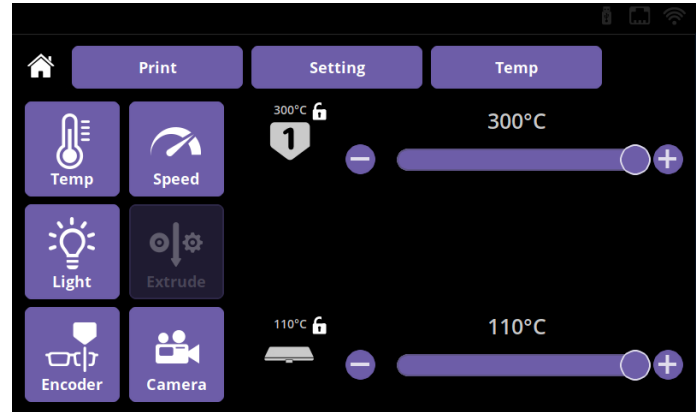

5.8. File management

Flow generation machines has a 4GB internal storage for printable items. In the Print menu, you can copy, move or delete one or more items. Copy and move possible between internal storage and the flash drive, in both directions.

To access the file actions, press the Action  button.

- To perform a file action, select the file / directory you want to perform the operation on. To enter a directory short press it. You can select directories, by long pressing them.
- Select the desired action from the Actions menu.
- Go to the destination directory for file transfer, and perform the paste operation. It will copy or move the files / directories to the selected directory.

Please note, the deleted files are not stored in recycle bin, and cannot be restored.



5.9. Calibration

You need to calibrate your printer periodically to ensure that you always print in good quality, and good adhesion to the build plate. There are a total of 4 calibration processes that ensure perfect print quality.

There are a few important rules to follow before calibrating:

- ! Heat up the nozzle and remove the filament from the extruder.
- ! Clean the plate and the nozzle tip.
- ! Make sure the metal plate is pushed back as far as it will go.

To perform the calibration, please follow the next steps:

- Select the Settings  menu on the LCD screen and touch the Calibrate  icon
- Select which calibration process you want to perform
- Press Start

5.9.1. Assisted bed calibration

Adjusts the parallelism between the build plate and XY mechanics, and the distance between the nozzle and the build plate.

The assisted bed calibration requires you to manually adjust the build plate. It will be adjusted using the 3 knob screws at the bottom of the build plate. There is one knob at the front in the middle and two in the back left and right corners of the build plate.

At the beginning of the process, the printer measures the distance between the build plate and the nozzle tip using the BL-Touch sensor. If the distance or parallelism is not optimal, the calibration will begin.

The print head begins to measure at the front in the middle point. At the bottom of the screen, you can see the scale of the deviation.

If the deviation is large, the markings are dense. The arrows below the markings indicate which direction the knob should be twisted to achieve optimum adjustment.

To achieve optimum value, the meter should be wrapped between two prominent lines.

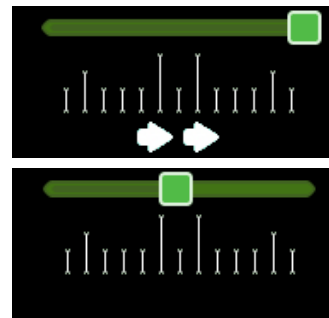

If the measurement is correct, the Next button appears. By pressing the button the printer proceeds to the next measuring point. Once all three measurement points have been completed, the printer will re-check the distances.

If all is well, the measurement process is complete.

5.9.2. Mesh bed leveling

Creates a map of the build plate and compensates for any surface inequalities while printing the first few layers. For this calibration, no user intervention required.

During the process, the printer measures the build plate at 3 different temperatures: 60°C, 80°C, 100°C

This process takes 15 minutes to complete.

5.9.3. Extruder (FMS) calibration

This calibration is measuring the Filament Monitoring System (FMS) sensor values, and adjusting it, if necessary. For this calibration, no user intervention required.

Please make sure that filament is loaded into the head you want to calibrate, before starting the process.

5.9.4. Offset calibration

This calibration process calibrates the following parameters:

Z limit distance: Required for resume printing function.

BL-Touch - nozzle offset: Required for the assisted bed and mesh bed leveling.

5.10. Removing objects from the build plate

The Craftbot FLOW printer are equipped with removable flexible build plate. Removing printed items from the build plate is easier than ever.

Please follow the steps:

- Remove the build plate from the printer.
- Allow the build plate to cool down to room temperature.
- Bend the build plate as seen on the picture.

Please note, if the object is still warm, it may bend when removed.

Please do not over-bend the build plate! It may damage it permanently.

5.12. Firmware update



Craftbot FLOW printers are able to update itself through Internet or from flash drive. We are continuously improving the features of our printers for the best user experience.

If the printer is connected to the Internet, and the update reminder function is enabled, the printer warns you, when a new firmware is available.

If the printer is connected to the Internet, but the update reminder function is disabled, the printer need to be updated from the Update menu.

If the printer is not connected to the Internet, you may have to download the latest firmware from our website (<https://craftbot.com/firmware>), and copy it to the root folder of a flash drive, without unpacking.

Please follow the steps:

- If you want to update from flash drive, insert the flash drive which contains the previously copied firmware file to the printer's USB port.
- Select the Settings  menu on the LCD screen, and touch the Update  icon.
- Select the source from where you want to perform the update.

Please do not interrupt the process, or unplug the printer during firmware update. The update process takes about 3 minutes.

When the update is finished, please restart your printer.

6. CRAFTWARE

To print a 3D object, The Craftbot needs toolpath information generated from 3D object CAD files like .obj or .stl.

Toolpath information is simply called "gcode". CraftWare software converts 3D design files into printing commands for the Craftbot 3D printer. CraftWare has been developed by CraftUnique with the aim of easing and perfecting the printing process.

For detailed user's instruction of CraftWare, download the user manual from:
<https://craftbot.com/docs/craftware-user-manual>





6.1. Installing CraftWare

Open a new browser session on the computer where you'd like to install CraftWare.

- Go to www.craftbot.com/craftware.
- Select the Windows or MAC/OSX or Linux version, according to your operation system.
- To select the latest version of CraftWare click the CraftWare Button below.
- Download the installer.
- Open the installer and follow the directions to install the software.

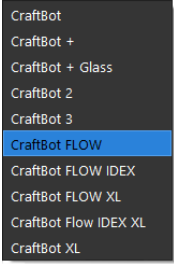
6.2. Using CraftWare to generate .gcode files

Once CraftWare has been opened up, you will see a virtual build platform which represents your Craftbot's real build plate.

- The Options  menu is located on the right side of the screen. In the pop-up window you can set the language, graphics, keyboard commands, colors and Craftbot type. All build areas of all the Craftbots are pre-set and programmed in.
 
- Select your printer under the Printer tab page. You can add objects, .stl, .obj files onto this virtual build plate and get an impression of what the real life print will look like.
- Select your desired Dual Head mode By clicking on Dual Mode  button you can change the Dual Head mode. There are four of them:
 - Dual Extruder Mode: You can assign an extruder for each object in the project.
 - Support Mode: lets You select one of the extruders to create the support bars.
 - Parallel Mode: Duplicates the objects, and print them simultaneously.
 - Mirror Mode: Duplicates and mirror the objects, and print them simultaneously.
- Click on the Add  button located in the top row of icons. Select the 3D design plan you want to print. The selected object will appear at the center of the virtual build plate. If Dual Extruder Mode is enabled, you can assign heads in the List View under the Selection tool.
- To generating the toolpath information (gcode) Click on the Slice  button to the right side of the screen. A new screen pops up with options to specify the printing quality and material to be used.
- Saving the gcode by clicking the "slice" button bottom right.
- You can save  the generated gcode onto a USB drive and place it into the top of the printer or send information directly to Craftbot if connected via USB cable.

7. USING THE WEB INTERFACE

7.1. Login

If you already configured your printer for network use, its IP address can be found on the main screen.

When you first login, write the IP address of your printer into the web browser. eg.: <http://10.0.1.21/>

Login to the site with the default username and password:

- Username: admin
- Password: adminadmin

After the login you may asked to change the username and password.

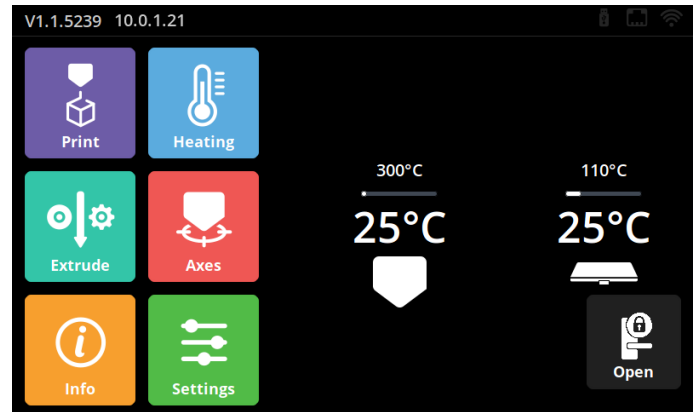

7.2. Main menu

After logging in, the Dashboard interface of the web interface opens. Here we can track the print data.

You can start, restart, pause, or stop printing in the top horizontal action bar.

Below you can see the current state of the printer, the head and the print tray heating.

On the left you can see the sub-menus. These are used to prepare the printer before printing. After you start printing, some of the menus will be inactive, such as extrude, temperature.

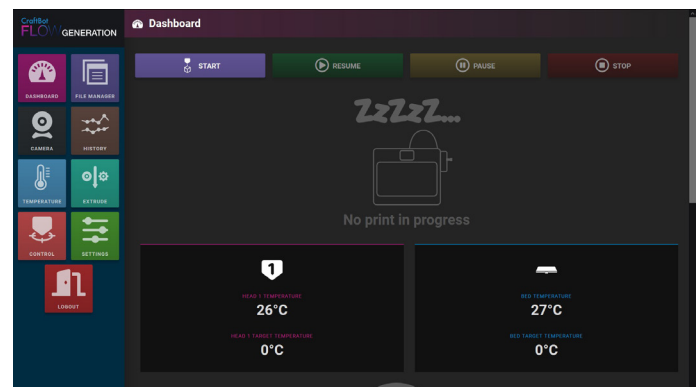

7.3. Uploading files through the WEB interface

In the File manager menu, you can drag and drop, or upload gcode files on the conventional way. Please note, only gcode files are allowed. If you have .stl file, you need to slice it before. See chapter 6.2.

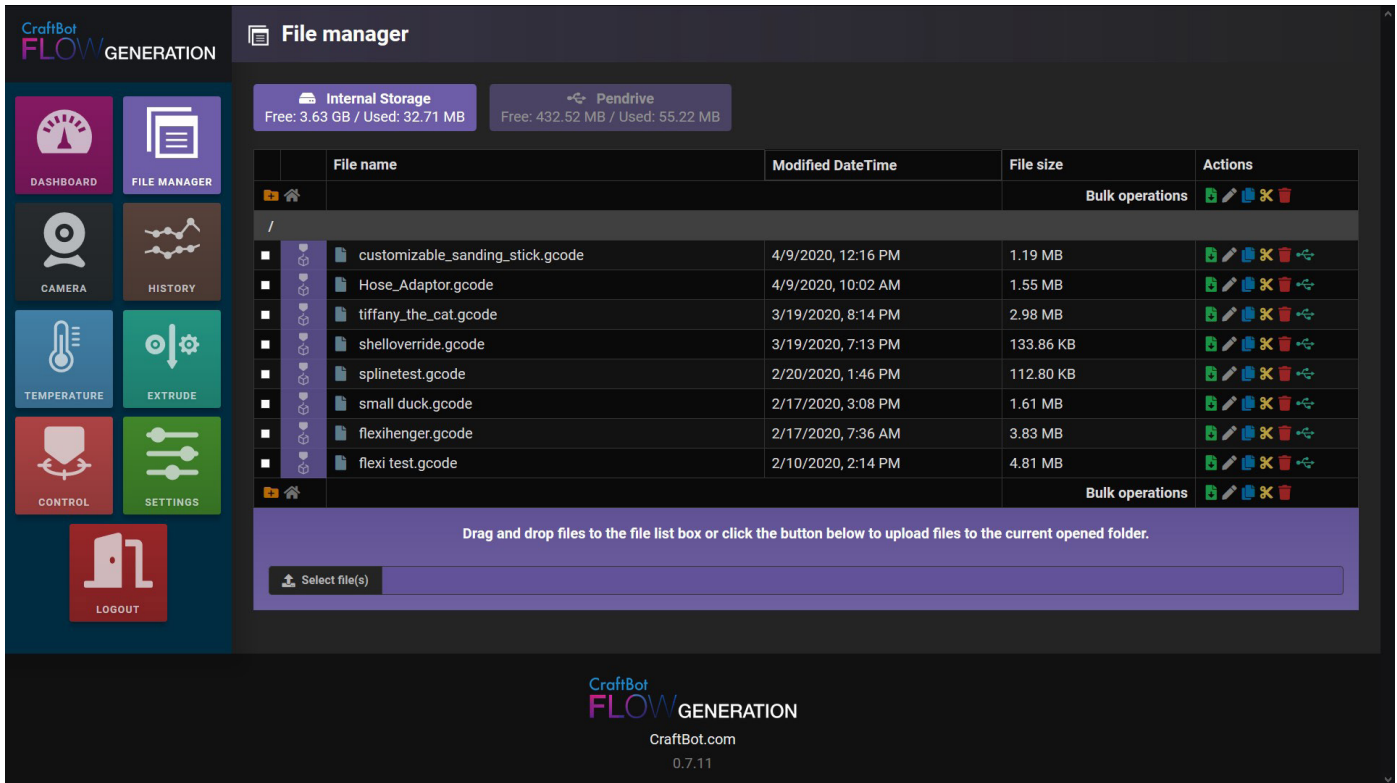

7.4. Printing objects through the WEB interface

In the File manager, you can see the available gcode files. You can print gcode files either from the internal storage or from the flash drive.

Press the Print  icon next to the file you want to print.

Confirm your decision with pop-ups, and then printing will begin.

On the Dashboard, you can follow the print process. The print bar shows the percentage of completion.

Some of the options will be unavailable during printing.

7.5. Watching the camera remotely

Craftbot Flow printers are equipped with built-in camera. This allows the user to view the print progress, spot failures, and to control the printer remotely.

To access the camera please login to the web interface, and choose Camera menu.
You can take snapshots of the image or make a video of the print.

You can directly access to the camera stream on <http://<printer ip address>/camera>.

The stream only accessible with the camera username and password. The camera has its separate username and password. This allows you to share the camera with operators, without revealing the user interface credentials.

8. CLEANING AND MAINTENANCE

IMPORTANT!

Cleaning and lubrication should only be conducted while the extruder and built plate are cold. Please allow the Craftbot 3D printer to cool down at least 30 minutes before cleaning or maintenance. It necessary to clean the printer after every 1000 hour. After every 1000 hour we need to change the used and worn parts in the printer. The printer will warn the user.

8.1. Cleaning

Clean the metal housing of the Craftbot by wiping with a damp cloth.

Cleaning the build plate with window cleaner or Acetone. Wipe clean with a dry cloth or paper towel.

8.2. Lubricating

The Craftbot printer should be lubricated at least once after every 50 hours of use or every 6 months.

Tools needed for lubrication:

- PTFE based spray lubricant or grease
 - 2 separate lint-free rags or thicker stronger paper towels
 - Personal protection such as gloves and safety glasses/goggles
 - Lighting to see the interior of the Craftbot correctly (lamp)
1. Move the build plate and the extruder to the „Home“ position.
 2. Once the extruder and bed are in the home position, turn the Craftbot printer off and unplug it from the electrical outlet.
 3. If you look beneath the build plate you will see three rods that run vertically in which the build platform moves up and down on. The two outside rods are smooth and the center rod is threaded. These three rods are known as the “Z-axis rods”.
 4. Place a folded paper towel or a lint-free rag behind the center rod. This rag is used to protect other areas of the printer from any over-spray that may occur.
 5. LUBRICATE ONLY THE PARTS RECOMMENDED IN THIS MANUAL!
 6. Spray the threaded Z-axis rod at a relatively close distance to reduce over-spray. Make sure the lubricant reaches the inside of every thread (if using grease, spread with hand wearing gloves).
 7. Make sure not to over-lubricate, spray only the minimum required amount!
 8. Do not spray the other two rods directly! Spray the towels and wipe it onto the rods.
 9. Remove the rag from the Craftbot interior.
 10. Plug in and power up the Craftbot and move the build plate to the lowest point (go to Axes menu, and press the Z down arrow until the bed reaches the lowest point).
 11. Turn the Craftbot printer off and unplug it from the electrical outlet.
 12. Place a second clean rag on top of the heated build plate to protect the components and Kapton from any over-spray.
 13. Repeat the process for the top side of the Z-axis rods the same as you performed on the bottom side: protective rag behind threaded rod, spray, wipe excess lubricant on other two outside rods.
 14. Power up the Craftbot once again and raise the build plate back up to the highest position (set the X, Y and Z to the home position).
 15. Turn the Craftbot printer off and unplug it from the electrical outlet.
 16. Wipe any excess lubricant off from the bottom side of the Z-axis rods.
 17. Power up your Craftbot once again and move the build plate back to the lowest point.
 18. Turn the Craftbot printer off and unplug it from the electrical outlet.
 19. Wipe any excess lubricant off from the top side of the Z-axis rods.
 20. Power up the Craftbot once again and raise the build plate back up to the highest position.
 21. Turn the Craftbot printer off and unplug it from the electrical outlet. The motors will now disengage so that you can move the extruders freely by hand.
 22. Use an oiled rag to lubricate the X and Y linear rails. Do not spray from above! Move the extruders back and forth by hand to both extremes of the axes. When the extruders move absolutely smoothly you are finished.

8.3. Removing clogging of the extruder

The number one inconvenience that you will run across when 3D printing is clogging of the extruder. But we have good news for you! This problem can be easily avoided by following a few simple rules of "3D printing etiquette".

- First, always wait until the extruder is fully heated to its intended temperature before inserting the filament. Inserting the filament at a lower temperature is just asking for a clog.
- When unloading or changing the filament: always heat up the extruder all the way first. Then "Extrude" for 5 seconds and then immediately press "Reverse" aiding the filament retrieval by pulling a little bit on the filament end coming out of the extruder with your fingers. The "Extrude" is necessary, because the hotend needs to melt the whole previously melted filament.
- If the extruder is clogged clean out the passageway of the extruder. You can use one of the small hex wrenches that came with the Craftbot. To do so. Heat up the extruder to 250 °C While the extruder is empty push down any excess filament out by plunging the hex wrench down into the passageway: Make sure to do adequately but not in a violent way which would damage the machine, and always take precautions because the extruder is very hot!
- It is especially important to clean out as much old filament leftover between using different filaments, as the different characteristics of the filaments' properties (even printing the same material in a different color) can cause clogs from inconsistencies. For example: you must heat up to 250°C to clear out any extra ABS before using PLA.

Clogging is the most common problem in every 3D printer and cannot be prevented 100%, but if you follow these simple steps you will prevent 95% of occurrences. If you still cannot clear the passage with just this method, you may want to move onto the next method by following these next steps to actually remove the nozzle itself...

8.4. Removing the nozzle

Remove the filament from the head or cut the filament at the point closest to the extruder.

- Remove the head only when it completely cooled to avoid burns.
- In the Navigation menu, lower the bed level for convenient head access during the process.
- Turn off the printer.
- The fan assembly on the head can be removed using the 2-2 screws on the sides. The fan unit can then be easily removed.
- Loosen the screw on the head at the bottom of the silicone cover, but do not unscrew it. Pull out the heat cartridge and temperature sensor from the Heat-block.
- Loosen but not remove the 2 screws on the left side of the black Heat-sink.
- This allows the bottom head to be pulled out of the black block.
- Unscrew the nozzle and heat-break with wrenches.
- The two parts can now be cleaned comfortably with the Cleaning Kit.

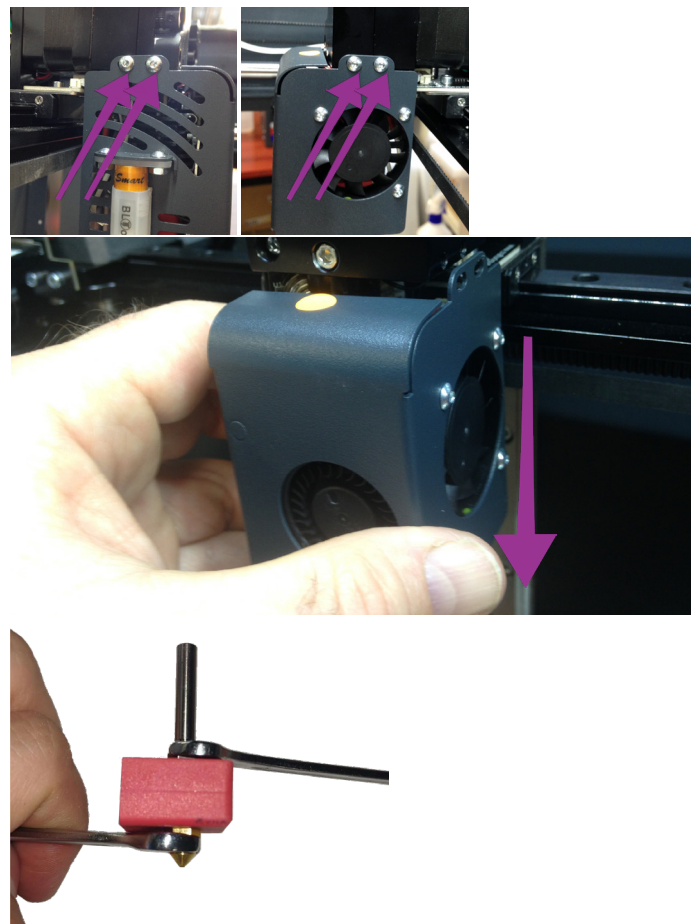

8.5. Replace the Fan set

If you have any problems from the BL touch intermittently or not working altogether or the fans not working, then Please follow the process below to investigate. This could be due to pins breaking or being miss aligned due to twisting of the Fan casing.

- On the left and the right side remove the screws with the 2 mm Allen key.
- With one hand, hold the fan assembly steady as you remove the last of the bolts.
- Lower the fan set about one centimeter and then move it forward away from the Extruder.

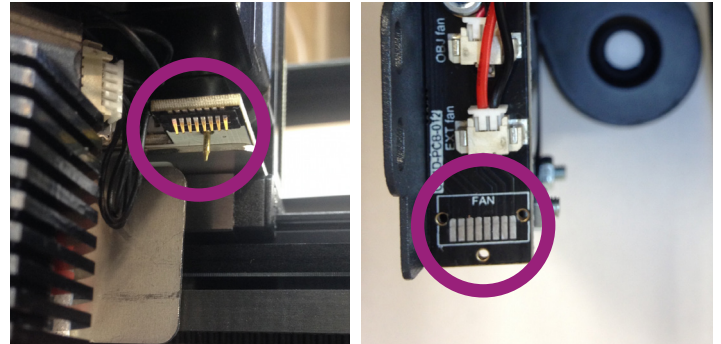

8.6. Relocation of the Fan assembly to the extruder assembly

- Moving the fan Assembly over the extruder first below the required height around about 1 centimeter. Gently lift the fan assembly to connect to the 2 boards together but first locate the central pin from the Extender board into the hole of the Fan extender board below it.
- When you have located the central hole align the side bolt holes of the Extruder with the fan casing holes and place an Allen key into the front bolt hole on the right side again to keep it steady.
- Start to place the first bolt into the rear hole on the right side. To hold the correct position taking some of the stress off the pins.
- Place the second bolt into the front left bolt hole to hold the fan assembly more level and upright onto the extruder Assembly. Now Remove the Allen key, to secure all 4 of the bolts to hold the fan set onto the extruder assembly.
- Then you have finished the dissemble and reassembly of the Extruder fan set from the extruder assembly.

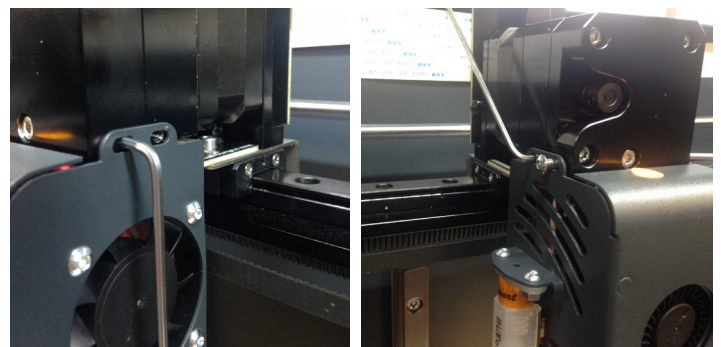
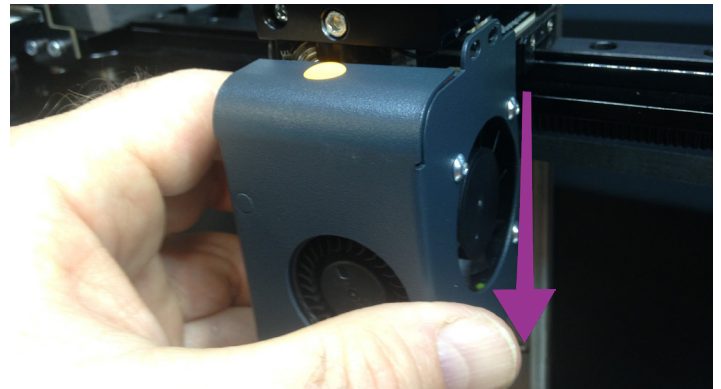

8.7. Applying a new Kapton sheet to your build plate

Build plate Kapton sheets get worn out in time or can be damaged by the nozzle due to incorrect levelling or removing the printed models. Reapplying a new Kapton sheet is essential to maximize print qualities if the old one has issues/ damages. To reapply a new Kapton sheet, take the build plate out of the machine and remove the old sheet by stripping it off of the flexible metal plate. Clean the surface of the plate with acetone.

Remove the protective plastic backing sheet (keep this safe for use later) from the new Kapton sheet. in order to get to the sticky side. Apply some window cleaning liquid onto the plate and the sticky side of the sheet to help you to correctly the position the sheet on the build plate. Align the Kapton to the front side of the laser marked grid. Once the positioning is correct, squeeze out the excess liquid from between the plate and the sheet with a thin but solid object, like a used credit card. Place the protective sheet (which was removed in the beginning) on top the new Kapton to prevent scratches and damages during this process.

Start from the center of the plate and move horizontally and vertically. Once all the liquid has been squeezed out and the sheet is applied properly, put the plate somewhere to dry. Allow the sticky part to rest for a day before using.

9. GUARANTEE AND LIMITATION OF LIABILITY

For special conditions relating to product guarantee, see the „Guarantee Statement“ on a separate sheet, which is also delivered with the product as well.

With the exceptions included in the regulations concerning the guarantee and to the greatest extent permitted by the relating act, Craftunique Ltd. is not responsible for any direct, indirect, specific, stochastic or consecutive damage claims which are stem from the breaching of the terms of guarantee, respectively any other legal theory, included, but not limited to:

- The loss of usability
- The loss of income, the loss of actual or expected profit (including the profit from contract), the loss of expected saving, loss of business, loss of opportunity,
- The loss of a fair name and injury to a fair name,
- The loss, injury or perishing of data,
- Any indirectly or consecutively caused damage or loss, including the damage caused by the changing of equipment/installation or property, respectively
- The cost of the restoration or reproduction of data stored or used on the Product.

The restriction above does not refer to Craftunique Ltd.'s legal liability for intentional, serious negligence and/or default. Certain jurisdictions don't allow the exclusion or limitation of accidental or consecutive damage, therefore if such jurisdiction regulates the guarantee, the restrictions above does not refer to You.

Concerning any problems or inquiries, you can contact us at: support@craftunique.com

Cooperation between 3D printer and people has never been easier.

Get in touch!

CONTACT:

CraftUnique Ltd.

Salgótarjáni str. 12-14.

Budapest 1087, Hungary

Phone: +36 1 700 8060

Web: www.craftbot.com • www.craftbotusa.com

Craftbot is made in the EU.

Copyright 2013-2020 by CraftUnique Ltd. All Rights Reserved.



craftbot