

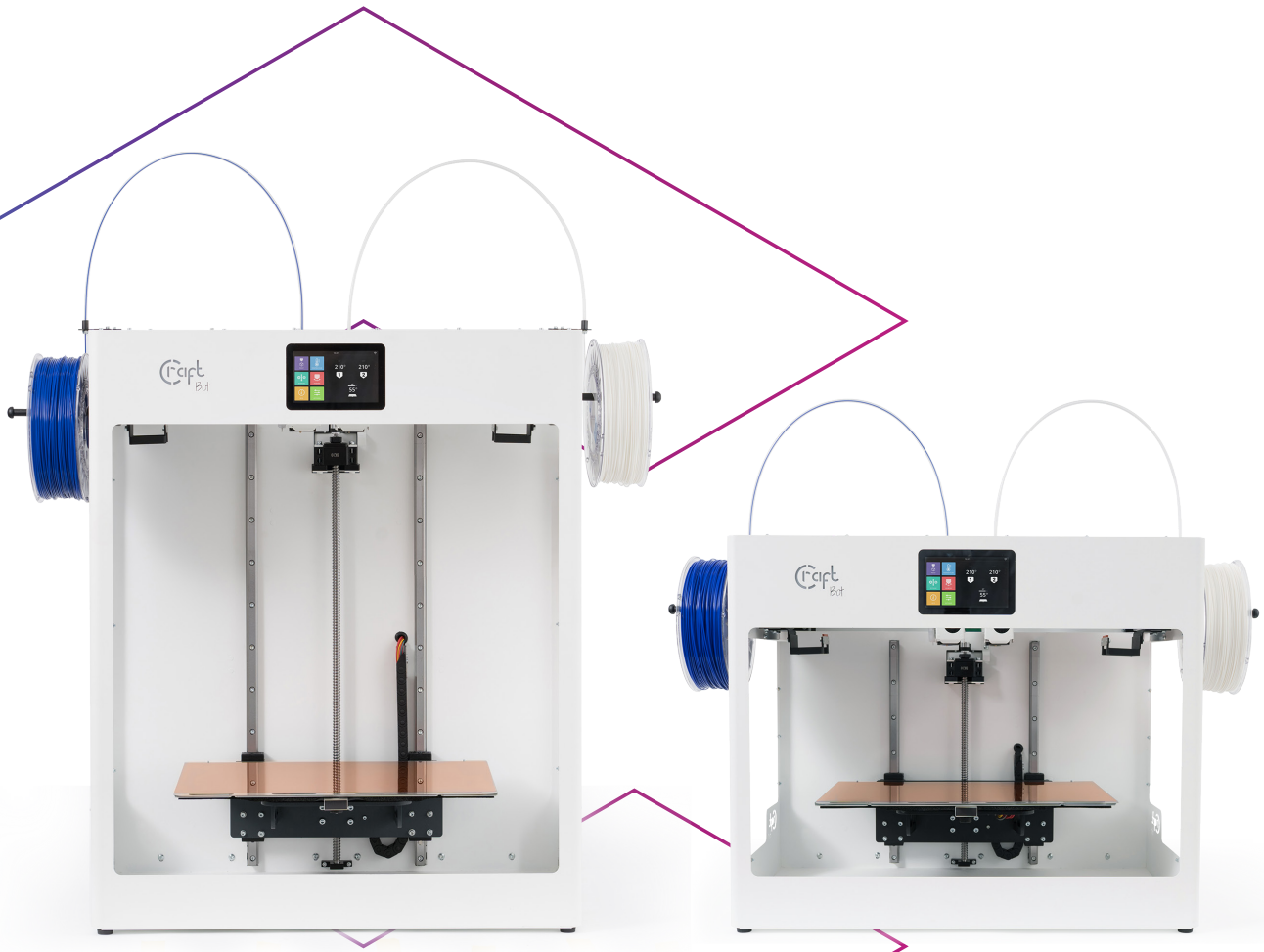

**craftbot**  
**FLOW GENERATION**

**IDEX USER MANUAL**



# TABLE OF CONTENTS

- 1. INTRODUCTION . . . . . 3
- 1.1. Craftbot Flow / Flow XL printer components . . . . . 4
- 1.2. Specifications . . . . . 5
- 2. SAFETY . . . . . 6
- 2.1. Warnings . . . . . 6
- 3. UNPACK AND ASSEMBLY. . . . . 7
- 3.1. Unpacking the printer . . . . . 7
- 3.2. Accessories . . . . . 7
- 3.3. Assembling the Craftbot Printer . . . . . 8
- 4. First steps . . . . . 9
- 4.1. Switching on the Appliance . . . . . 9
- 4.2. Printer wizard . . . . . 9
- 5. OPERATING THE PRINTER . . . . . 10
- 5.1. Menu map . . . . . 10
- 5.2. Heating up the printer . . . . . 11
- 5.3. Loading the filament . . . . . 11
- 5.4. Unloading the filament . . . . . 12
- 5.5. Changing filaments . . . . . 12
- 5.6. Start a print . . . . . 13
- 5.7. In-print adjustments / pause menu . . . . . 13
- 5.8. File management . . . . . 14
- 5.9. Calibration. . . . . 15
- 5.9.1. Assisted bed calibration. . . . . 15
- 5.9.2. Mesh bed leveling. . . . . 15
- 5.9.3. Extruder (FMS) calibration . . . . . 16
- 5.9.4. Offset calibration . . . . . 16
- 5.10. Removing objects from the build plate . . . . . 16
- 5.11. Firmware update. . . . . 17
- 6. CRAFTWARE . . . . . 18
- 6.1. Installing CraftWare. . . . . 18
- 6.2. Using CraftWare to generate .gcode files. . . . . 18
- 7. USING THE WEB INTERFACE. . . . . 19
- 7.1. Login . . . . . 19
- 7.2. Main menu . . . . . 19
- 7.3. Uploading files through the WEB interface. . . . . 20
- 7.4. Printing objects through the WEB interface . . . . . 20
- 7.5. Watching the camera remotely . . . . . 21
- 8. CLEANING AND MAINTENANCE. . . . . 22
- 8.1. Cleaning . . . . . 22
- 8.2. Lubricating . . . . . 23
- 8.3. Removing clogging of the extruder. . . . . 24
- 8.4. Removing the nozzle . . . . . 24
- 8.5. Replace the Fan set. . . . . 25
- 8.6. Relocation of the Fan assembly to the extruder assembly . . . . . 25
- 8.7. Applying a new Kapton sheet to your build plate. . . . . 26
- 9. GUARANTEE AND LIMITATION OF LIABILITY. . . . . 26

## 1. INTRODUCTION

Congratulations on your purchase of the Craftbot Flow Generation printer and welcome to the world of 3D crafting! We at CraftUnique believe that 3D printing opens a new window to enhancing creativity. It offers an outstanding crafting experience even without a prior background in programming or 3D printing.

How does the printer work? The Craftbot 3D printer makes solid, three-dimensional objects from melted plastic filament. First you will have to design your objects with the help of a 3D design program. Then you will need to use the CraftWare program (downloadable from [www.craftunique.com/craftware](http://www.craftunique.com/craftware)) to transform your 3D design files into printing instructions for the Craftbot 3D printer. Transfer your files to Your Craftbot 3D printer via USB or Wi-Fi. The Craftbot 3D printer will melt plastic filaments and squeeze them out onto the building plate in thin lines to print your object layer by layer.



## 1.1. Craftbot Flow /XL printer components

1. Filament guide tube
2. Touchscreen LCD display
3. Hotend
4. Build plate
5. Z axis rod

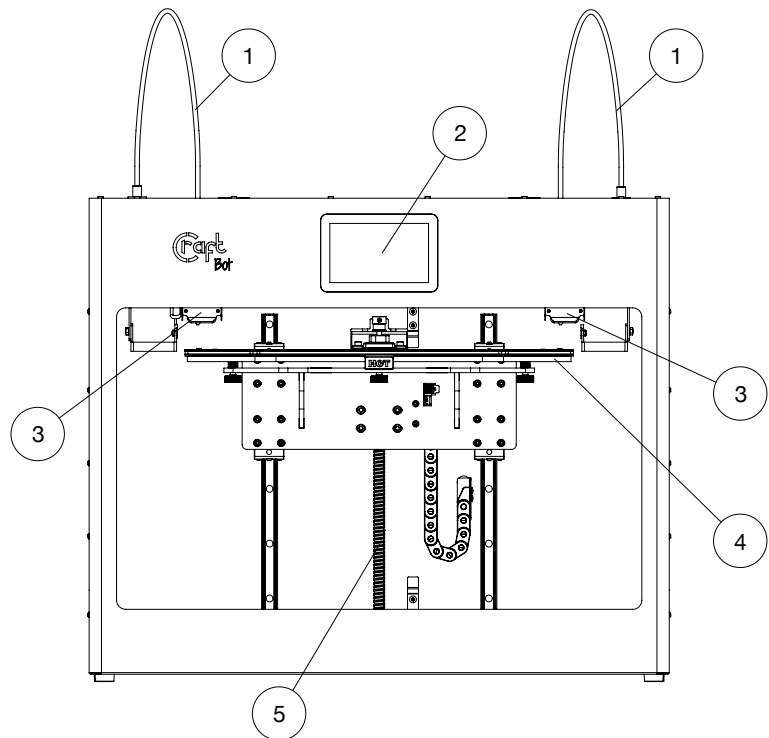

6. USB connector for flash drive
7. Extruder
8. Filament guide tube holder
9. Filament spool holder
10. Filament spool
11. ON / OFF switch
12. AC power cable
13. LAN connection
14. Reset button

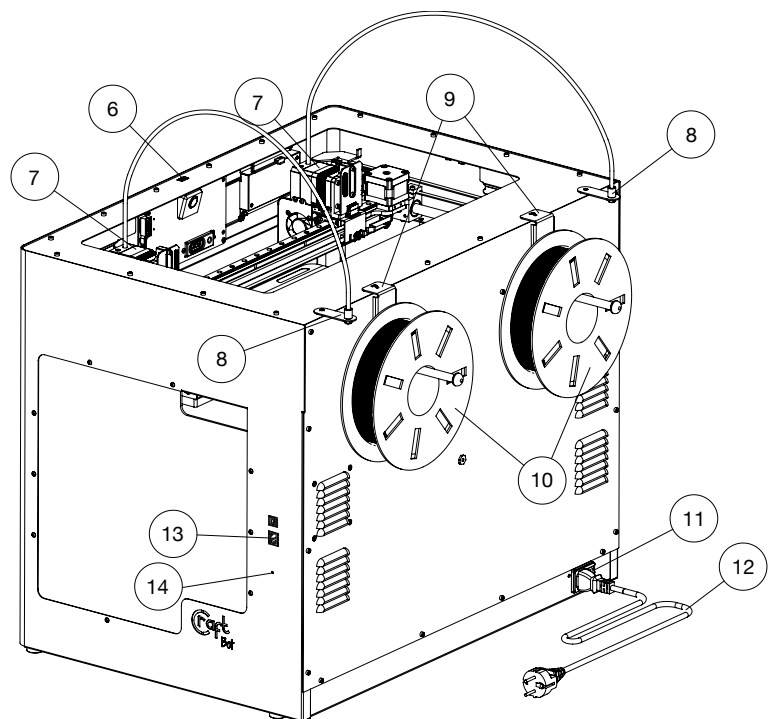

The model displayed is the Craftbot Flow IDEX.  
The difference between the two models is the frame height.  
See Specifications for the different dimensions.

## 1.2. Specifications

PRINTING PROPERTIES	FLOW IDEX	FLOW IDEX XL
Printing technology	Fused Filament Fabrication (FFF)	
Printing heads	Independent Dual Extruders (IDEX) with Filament Monitoring system (FMS)	
Build volume	X: 425mm x Y: 250mm x Z: 250mm	X: 425mm x Y: 250mm x Z: 500mm
Theoretical precision	X,Y: 4 microns, Z: 2 microns	
Layer resolution	For 0.4mm nozzle recommended 50-300 microns	
Travel speed	Up to 160mm/s	
Print speed	Up to 160mm/s	
Build speed	0.4mm nozzle: up to 19.2 mm <sup>3</sup> /sec	
Build plate	Heatable, magnetic build plate, with removable spring steel build surface	
Build plate temperature	40 - 110°C	
Filament diameter	1.75mm	
Supported materials	PLA, ABS, HIPS, PET-g, Nylon, TPU, PVA, Moldlay (wax like), up to 300°C	
Nozzle diameter	Default: 0.4mm, supplied: 0.25mm, 0.4mm, 0.6mm, 0.8mm	
Nozzle temperature	40 - 300°C	
Hotend	All metal hotend	
Extruder	Dual drive extruder, ratio: 5,06:1	
<b>CALIBRATION</b>		
Build plate calibration	Assisted bed calibration	
XY calibration	Fully automatic, no intervention required	
<b>POWER REQUIREMENTS</b>		
Voltage range	90-264V	
Frequency range	47-63Hz	
Power factor	PF>0.95/230VAC	
Efficiency (Typ.)	94,5%	
Power MAX	500W, 5.5A	
<b>OTHERS</b>		
Display	5 inch, active matrix color display 800 x 480 pixels	
Connectivity	Wi-Fi, LAN, USB, Flash drive	
Internal storage	4GB, non removable	
Wi-Fi	IEEE 802.11b/g compatible	
Monitoring	IOT Web interface, Live camera	
Camera resolution	5MP, Stream output 800 x 600	
Operating noise level	50dBA	
Optional accessories	Glass door, ventilated PET-g dome	
<b>PHYSICAL</b>		
Frame	All steel frame	
Frame dimensions	X: 635mm, Y: 450mm, Z: 540mm	X: 635mm, Y: 45mm, Z: 790mm
Equipped with dome	X: 635mm, Y: 450mm, Z: 700mm	X: 635mm, Y: 45mm, Z: 950mm
Weight	32 kg	38 kg
Shipping weight	46 kg	52 kg
Available colors	White, Grey	
<b>OPERATING CONDITIONS</b>		
Operating ambient temperature	10-35 °C	
Humidity	10-90% RH, non-condensing	
Storage temperature	0-35°C	
<b>SOFTWARE</b>		
Supplied software	CraftWare, our free slicer software	
Supported OS	Windows, macOS, Linux	
Supported file types	STL, OBJ, 3mf	

## 2. SAFETY

Read this user manual carefully before you use the appliance, then save it for future reference. All information in this user manual is subject to change at any time without notice and is provided for convenience purposes only. CraftUnique reserves the right to modify or revise this user manual in its sole discretion and at any time. By using the manual, you agree to be bound by any modification and/or revisions. For up-to-date information contact the CraftUnique Service Support team ([support@craftbot.com](mailto:support@craftbot.com)).

### 2.1. Warnings

Check if the voltage indicated on the back of the appliance corresponds to the local mains voltage before you connect the appliance.

- Do not immerse the cord, the plug or the main body in water or any other liquid. This may cause electrical shock.
- Do not use the appliance if the plug, the mains cord or the appliance itself is damaged or not operating properly.
- If the mains cord is damaged, you must have it replaced in order to avoid hazard.
- Connect the appliance to grounded wall sockets only.
- Keep the mains cord away from hot surfaces.
- Do not let the mains cord hang over the edge of the table or worktop on which the appliance stands.
- Keep the appliance and its cord out of the reach of children.
- This appliance can be used by children aged from 8 years and above and by persons with reduced physical, sensory or mental capabilities or a lack of experience and knowledge. These latter persons should be under supervision and given adequate instruction concerning the use of the appliance in a safe way, understanding the hazards involved. Cleaning and user maintenance shall not be performed by children.
- Children can receive great educational benefits from designing 3D objects, but the printing process should not be done by small children.
- Do not touch moving parts or heated elements: you may suffer injuries.
- Never reach inside the printer when it is turned on. Different parts of the unit (mainly the extruder and the heated build plate) operate at very high temperatures and can cause severe burns.
- Never leave the Craftbot 3D printer unattended while it is plugged in, and is in operation.
- Make sure that the power supply is switched off and that the power cord is disconnected before servicing. Allow at least 5 minutes for the device to cool down after unplugging it before reaching inside to service.
- Always turn off the printer and disconnect it from the computer when it is not being used.
- Make sure to level the build plate properly before use.
- Make sure not to force any parts of the unit, be during unpacking, setup, operation or service.
- Service and lubricate the suggested parts as often as recommended. Use only substances recommended by CraftUnique.
- The Craftbot 3D printer melts plastic during printing. Plastic odors/gases are emitted during this operation. Make sure to set up the Craftbot 3D printer in a well-ventilated area.
- Do not change or adjust anything on the printer, unless the modification is authorized by the manufacturer.
- Do not store items in the printer.

## 3. UNPACKING AND ASSEMBLY

### 3.1. Unpacking the printer

1. Please check the packaging for any damage. If you detect any damage please contact the reseller.
2. Place the Craftbot box on the ground on a level surface. Make sure that there is plenty of open space around you.
3. Open the box with care, not to damage the contents if you are using a blade. Be careful and watch out for the printer as well.
4. Remove the strips and pull off the top box. If the strips are missing from the packaging, contact your reseller.
5. Remove the protective foam insert. You will find the Quick Start Guide located inside the top protective foam insert.
6. There is a box inserted which contains the accessories (including a flash drive with a copy of the Craftbot user manual). Remove the box with care as it supports the extruder during shipping.
7. Now you will find the Craftbot 3D printer itself completely enclosed in a protective plastic bag. Open the plastic covering.
8. **You will notice 2 handle holes for picking up the unit.** Firmly grasp the frame of the Craftbot. Consider its weight. Request physical help if needed.
9. Make sure you do not touch the extruder or the electronic panel inside the appliance.
10. Place the Craftbot 3D printer on a stable and level surface with sufficient space surrounding around it.



### 3.2. Accessories

Below you can see the contents of the box. First of all, check the list to make sure nothing is missing.

- |   |                       |
|---|-----------------------|
| 1. AC Power cable according to your region (1x) | 6. Hex wrenches (5x)  |
| 2. Filament guide tube holder (2x)              | 7. Flash drive (1x)   |
| 3. Filament guide tube (2x)                     | 8. USB A-B cable (1x) |
| 4. Filament spool holder (2x)                   | 9. Nozzle kit (2x)    |
| 5. Filament spool (2x)                          | 10. Cleaning kit (1x) |

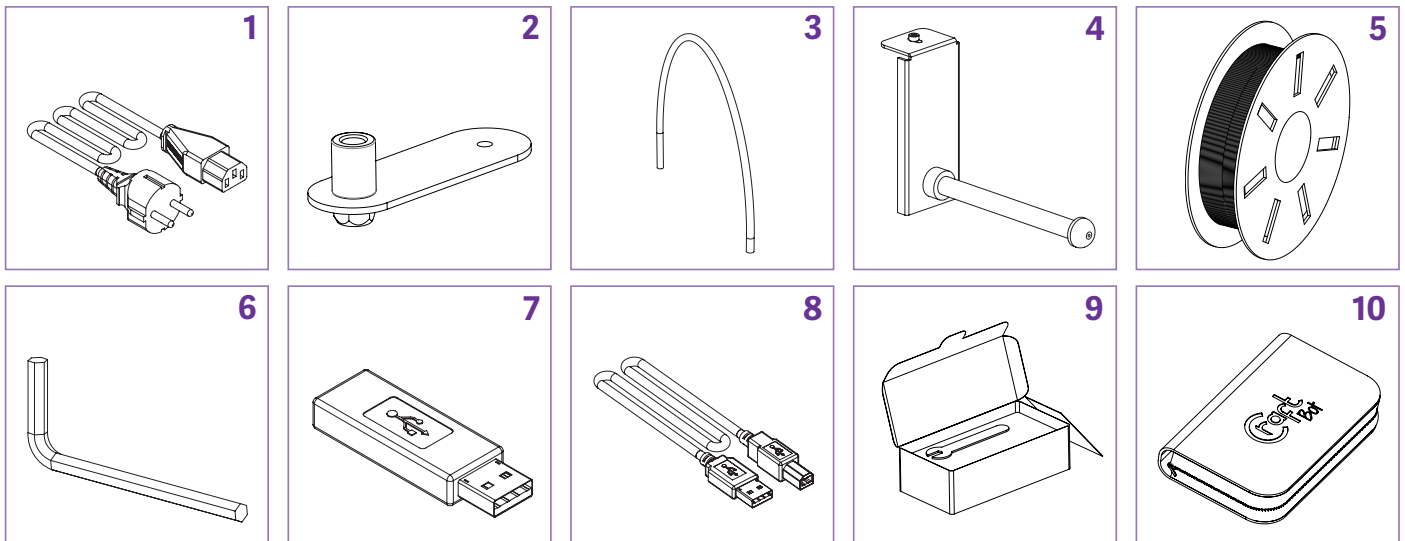

### 3.3. Assembling the Craftbot Printer

- Remove the X-rail clamps
  - To ensure your product was delivered safely, there are two clamps on the end of the X-rail. Safely remove these by using the hex key provided by unscrewing the 2 screws on each clamp.
  - Slide the clamps out by wiggling them from side to side.
  
- Install the filament guide tube holders
  - Select the desired position for the filament guide holders. Choose their position so that the filament spool holders fit beside them.
  
- Install the filament guide tubes
  - Locate the filament guide tubes.
  - Insert one end of the filament guide tubes into the filament guide tube holder on top of the Craftbot appliance.
  - Push the other end into the hole on the top of the extruder.
  
- Install the filament spool holders
  - Locate the filament spool holders.
  - Using a hex wrench, install the filament spool holder next to the filament guide tube holders.
  
- Mount the filament spools
  - Fit the filament spools onto the filament spool holders so that the lead end keeps its course when the filament is fed into the filament guide tube holder.
  
- Attach the power cord
  - Ensure that the power switch on the Craftbot is set to the OFF position.
  - Plug the AC power cord into the power input on the back of the unit.
  - Plug the power cord into a wall socket.

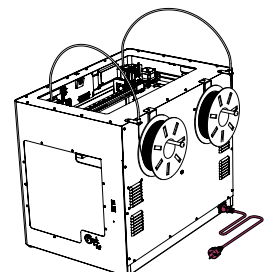
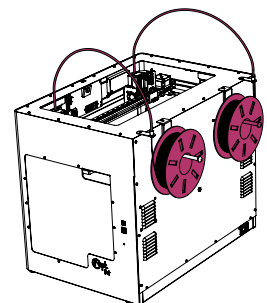
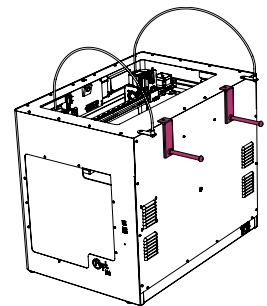
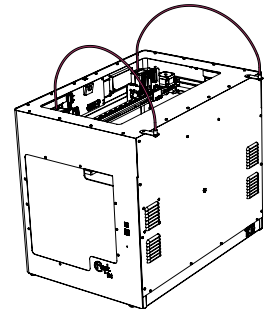
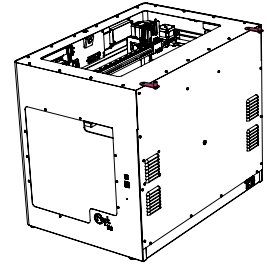
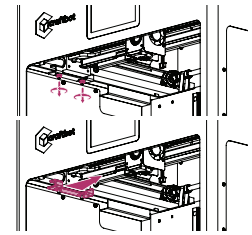



## 4. FIRST STEPS

### 4.2. The printer wizard

The first time you use the printer, the printer wizard will appear. The wizard will walk you through the steps needed to get the most out of your printer:

- Language
- Time zone
- Firmware update
- Network (LAN/Wi-Fi)
- Calibration

If you are unsure, you can always run the printer wizard from the setting menu.

#### Language

1. Select your language from the list
2. Then press Next

#### Time zone

1. Select your time zone from the list
2. Then press Next

#### Firmware update

1. Please don't skip this step!
2. Download the latest Firmware for the FLOW 3D printers at <https://craftbot.com/firmware>
3. Copy **CRAFT\_UPDATE.ZIP** to a FAT32 formatted USB drive
4. Plug the USB drive you found in the accessories box into the HMI port
5. Wait for the firmware update to complete

#### Network setup

1. Please name your printer. This name will help you identify the printer on the network.
2. Select the Ethernet or the WiFi network. The printer can use either Ethernet or WiFi. If you select the WiFi option the printer will turn off the Ethernet and vice versa.
3. If you selected the WiFi menu, please go to the WiFi menu.
4. Static IP or DHCP options: if DHCP is selected the printer will restart. The Searching button will list the available WiFi networks. Make your choice and enter the password using the keyboard shortcut.

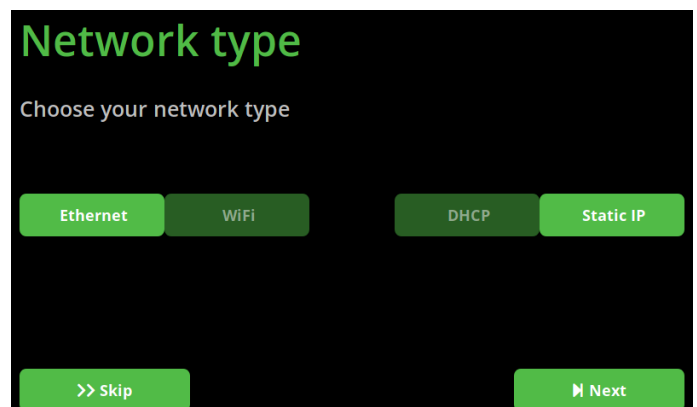
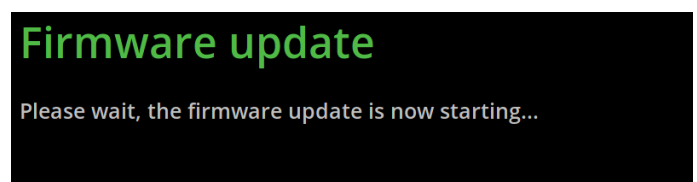
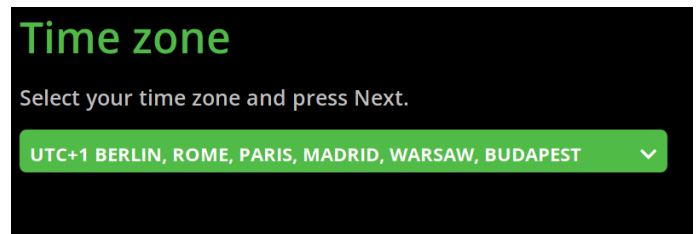
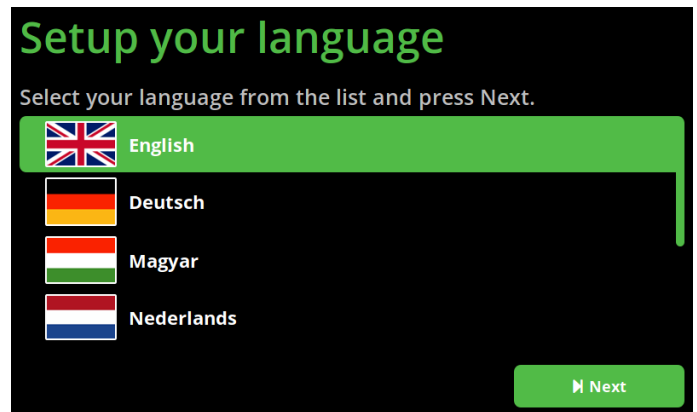
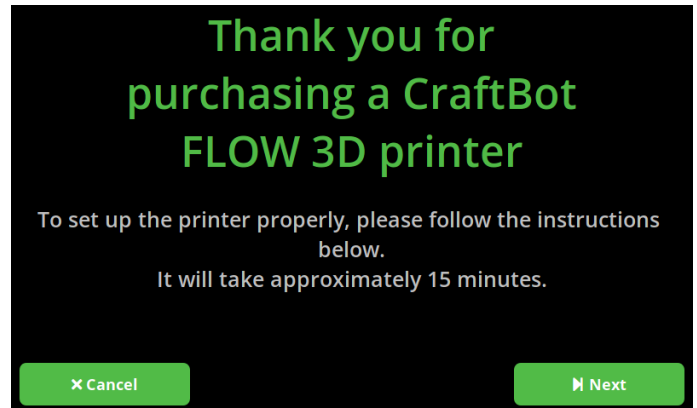

## 4.3. Welcome wizard- Calibration

1. Please make sure that the bed is clean and there are no residues / dirt on the nozzles. You can use the metal brush to clean the nozzle.
2. Remove every object that may be blocking the bed moving all the way down.  
*This process will take roughly 30 min. in total. Don't worry: most of it is automatic due to our mesh leveling system.*
3. Push Next on your screen.
4. In the first stage the printer will automatically check the lowest point of the bed can reach and also heat up the heads to PLA 215C° temperature. Press Next to start the automatic process.

### Offset calibration

The offset calibration requires manual adjustment on the printer. This calibration process calibrates the following parameters:

**Z limit distance:** Required for resuming a print job.

**BL-Touch - nozzle offset:** Required for the assisted bed and mesh bed leveling.

**Extruder 1 and Extruder 2 X-Y offsets:** Required for dual mode prints.

**Extruder Z offset:** Required for dual mode prints, to make sure the heads at the same height.

This adjustment is requires user intervention:

- The build plate moves down and moves the right head over the build plate and stops.
- Loosen the two screws on the left side of the heat-sink through the gap between the fan grilles and allow the nozzle to move down. If necessary, please press down the heat block with the hex wrench.
- Press the Next button. The build plate is now pressing up the loosened Extruder 2 to the proper height.
- Tighten both screws and press Next to continue calibration.
- After checking the two head levels, the X-Y calibration is automatic and requires no intervention.
- If the process is not clear, please press the video help button on the right side and watch the video.

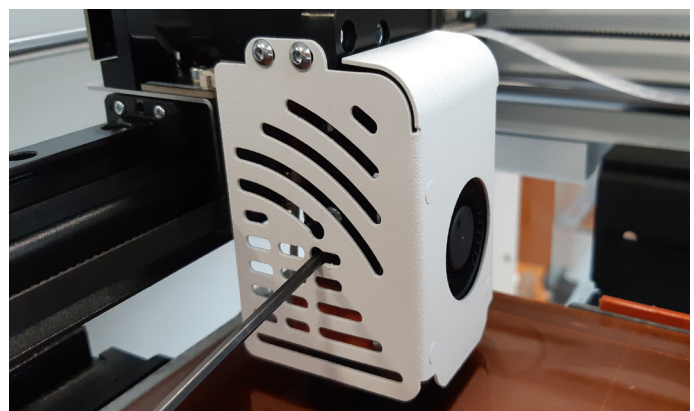
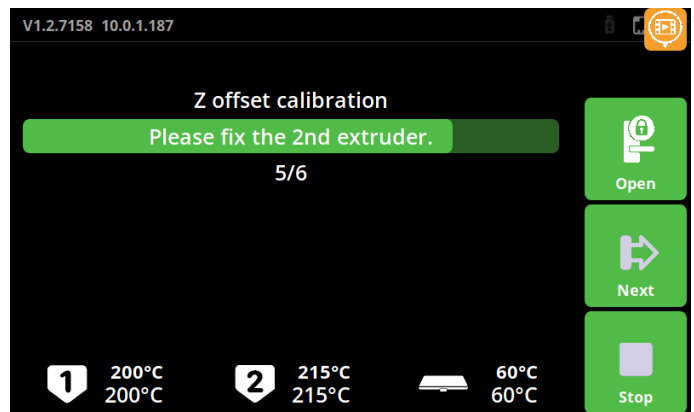
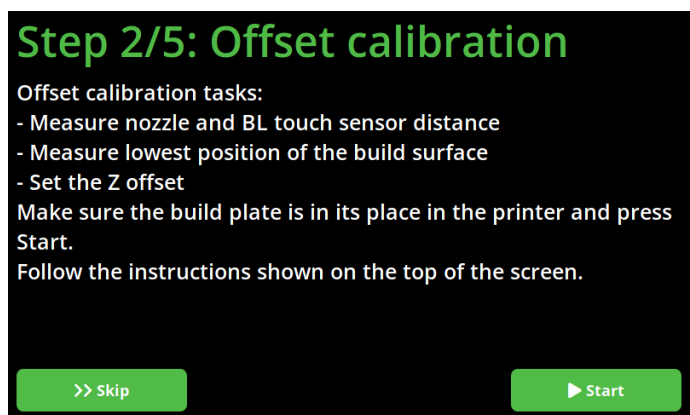
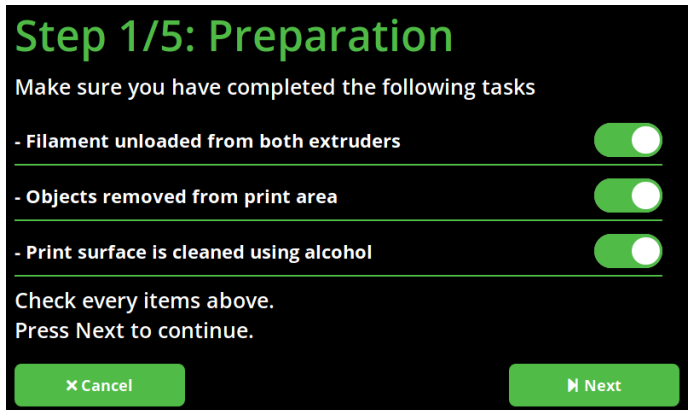

## Bed leveling

Adjusts the parallelity of the build plate and XY mechanics, and the distance between the nozzle and the build plate.

The assisted bed calibration requires you to manually adjust the build plate. It will be adjusted using the 3 knob screws at the bottom of the build plate. There is one knob at the front in the middle and two in the back left and right corners of the build plate.

- At the beginning of the process the printer measures the distance between the build plate and the nozzle tip using the BL-Touch sensor. If the distance or parallelity are not optimal, calibration will begin.
- The print head begins the measurement at the front centre calibration point. At the bottom of the screen, you can see the scale of the deviation.
- If the deviation is large, the markings are dense. The arrows below the markings indicate which direction the knob should be twisted to achieve optimum adjustment.
- To achieve optimum value, the meter should be wrapped between two prominent lines.
- After 3 optimal measurements, the NEXT button appears. If one or more of the 3 measurements is out of range, the calibration will not continue and will need to be adjusted using the knob.
- Press the NEXT button, the head is positioned above the back right button and then above the back left button screws.
- Repeat the procedure for the remaining two knobs.

If the measurement is correct, the Next button appears. If you press the button the printer will proceed to the next measuring point. Once all three measurement points have been completed, the printer will re-check the distances.

If all is well, the measurement process is complete.

## Mesh bed leveling

Creates a map of the build plate and compensates for any surface inequalities while printing the first few layers. For this calibration, no user intervention is required.

During the process, the printer measures the build plate at 3 different temperatures: 60°C, 80°C, 100°C

This process takes 15 minutes to complete.

### Step 3/5: Bed leveling

During bed leveling the machine will level the bed to the nozzle. It helps you to have an even first layer.

Press Start when ready.

Follow the instructions shown on the top of the screen.

>> Skip

▶ Start

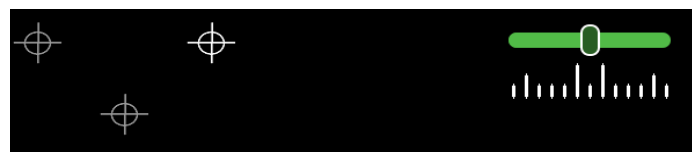
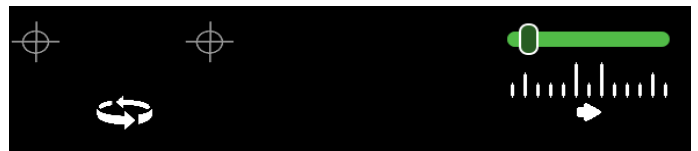
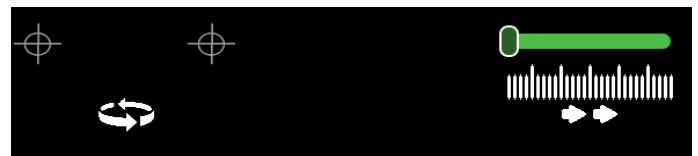

### Step 4/5: Mesh bed leveling

During mesh bed leveling the printer will make a map of your build surface. This measurement is performed at 60, 80 and 100 C to give the best results at all temperatures. The BL touch sensor will measure the distance of the bed and the nozzle. During printing the first layer Z offset will be compensated using these values. Press Start when ready.

>> Skip

▶ Start

## FMS calibration

This calibration will measure the Filament Monitoring System (FMS) sensor values and adjust if necessary.

Make sure you select the correct type of filament on the screen. The head heats up to the correct temperature. After it has heated, load the filament to the extruder.

To extrude filament from the print head, use the down arrow  on the touch screen.

- Press and hold the button to keep extracting filament through the head.
- Automatic filament feed can also be performed by pressing the Load  **Load** button on the bottom bar.
- By pressing the button once, the head automatically extrudes some filament.

Filament loading is successful when the melted filament flows out of nozzle evenly and vertically.

Caution! The freshly spilled melted filament is hot. Avoid contact with spilled filaments or other flammable materials in the nearby.

Press the Next button.

After successful FMS calibration you can print some cool things.

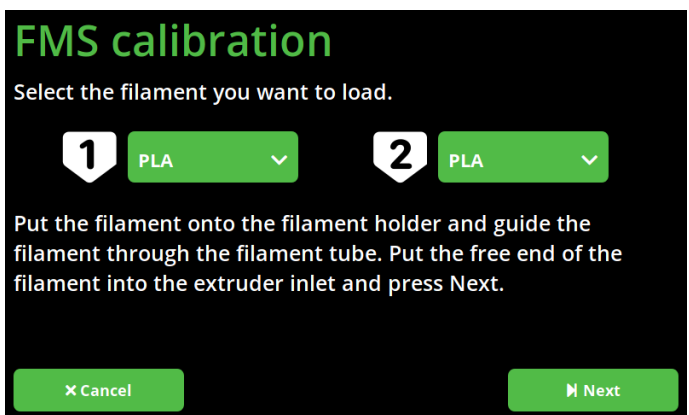
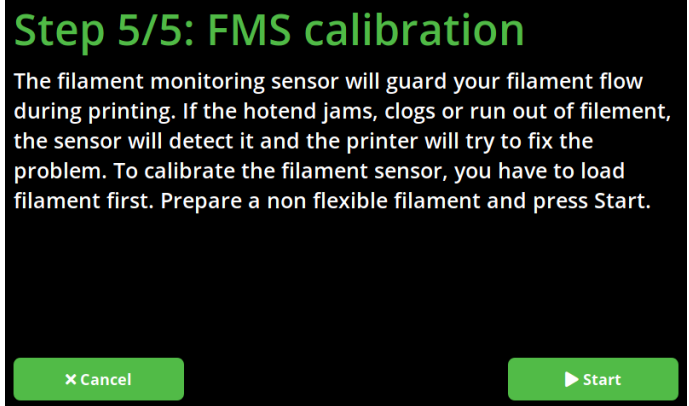

## 4.4. The first print job

Please print the CW\_ToolDisk\_dual.gcode or CW\_ToolDisk\_single.gcode files from pendrive. If you have not have this gcode please download it from this link and copy it to the pendrive:

<https://support.craftbot.com/hc/en-us/articles/360012631777-Craftbot-tooldisk-sample-test-object>

- Select the Print menu  on the main screen.
- Locate the file you plan to print. The files on the flash are found in the "pendrive" folder.
- Move the list up or down to locate the gcode of the item you want to print and select it. You can only select one gcode for printing, if multiple items are selected, printing cannot be started.
- Press the Start button in the bottom right corner of the screen.
- The machine warms up the print head and the build plate to the values specified in the gcode.
- Printing starts when the machine reaches the required operating temperature.
- After the object has been printed, remove the build plate. Printed objects can be removed easily, just bend the flexible build plate.
- Please note: if the object is still warm, it may bend when removed. To avoid this, please let it cool for a while.

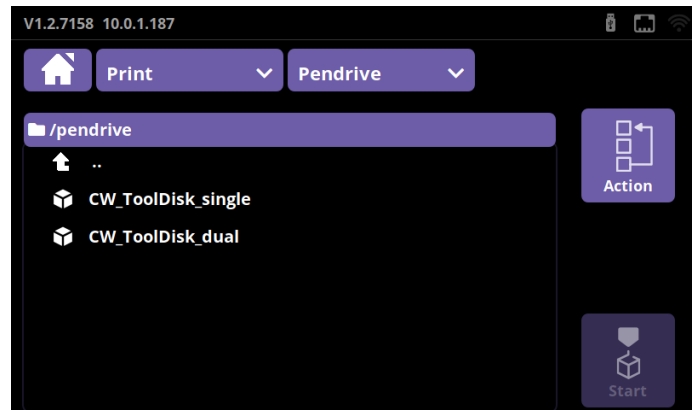

## 5. THE GRAPHICAL USER INTERFACE

### 5.1. Menu map

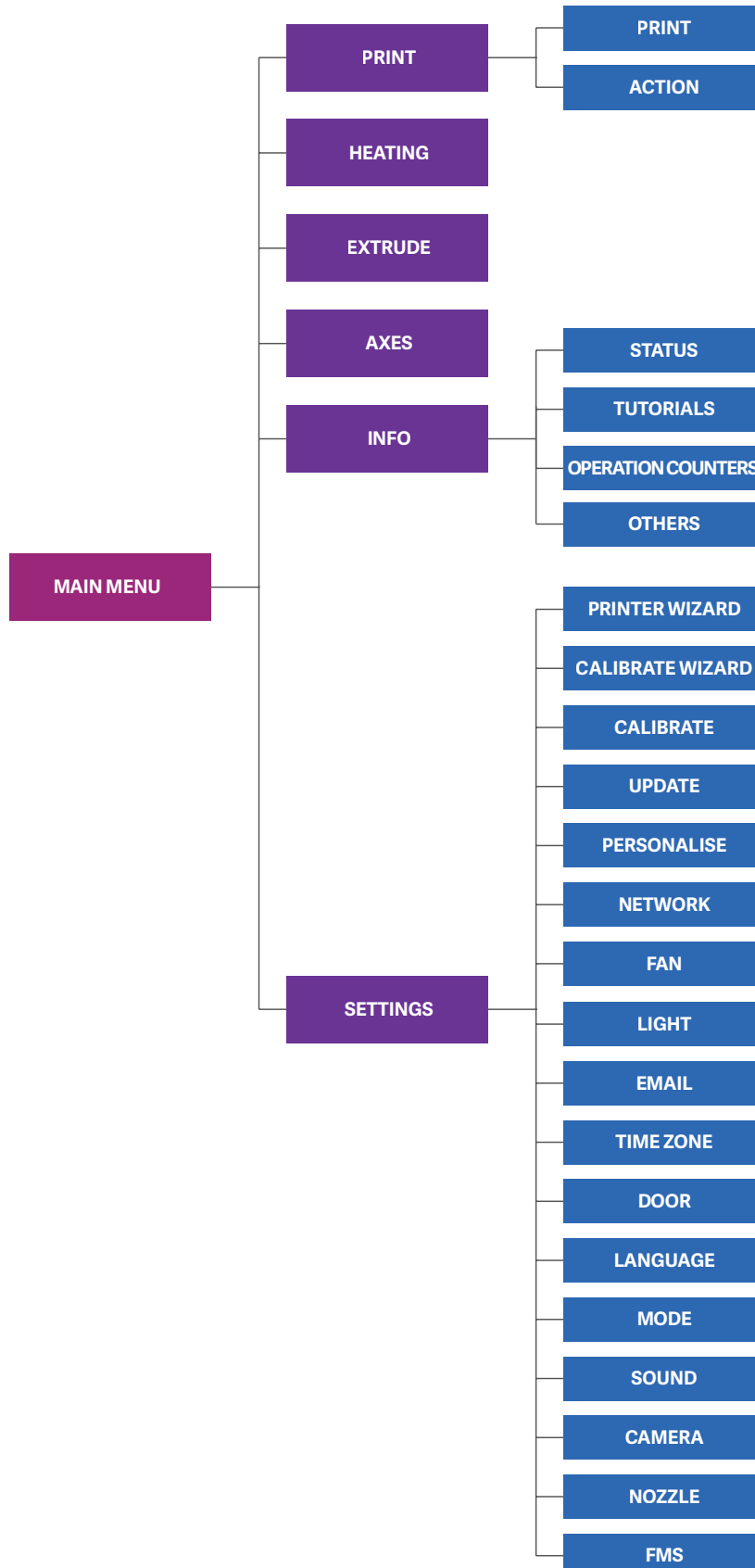

## 5.2. Home menu

Switch on the Craftbot printer with the ON / OFF button located at the back of the appliance.

The LCD panel on the front will light up.

You can navigate the touch screen by touching icons.

On the main screen, you can preheat the head to a preset temperature by pressing the print head or build-plate icon.

The display shows the following information:

1. HMI version number
2. The IP address (if the printer is connected to a network)
3. The flash drive icon if there is a flash drive plugged in
4. LAN icon (when the printer is connected)
5. The Wi-Fi icon when the printer is connected to a Wi-Fi network
6. Door open icon
7. Head heating icon
8. Bed heating icon

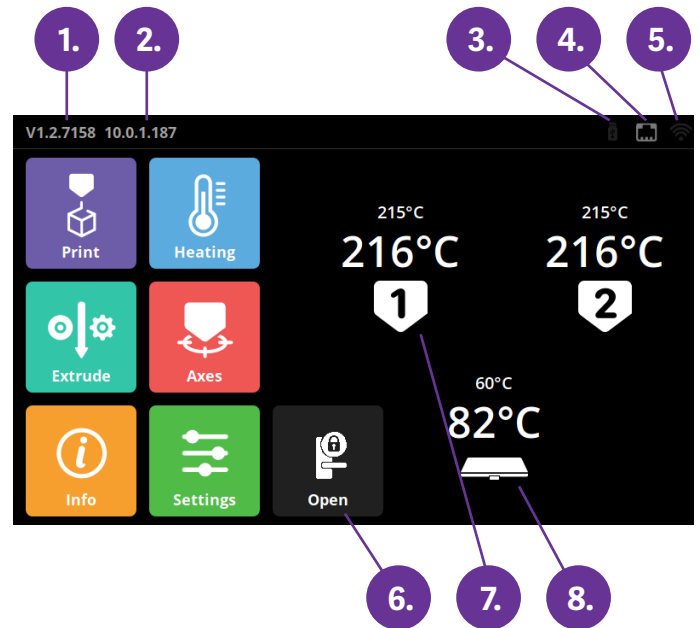

The main menu items are on the left side:

- Print
- Heating
- Extrude
- Axes
- Info
- Settings

You can switch the head and the bed heating on and off.

## 5.3. Print menu

You can print the previously saved .gcode files in more ways: either from the printer's 4GB internal storage or from a USB flash drive. Save the gcode file created by the CraftWare slicer program onto USB flash drive or directly to the printer's internal storage.

- Select the Print menu  on the main screen.
- Locate the file you plan to print. The files on the flash are found in the "pendrive" folder.
- Move the list up or down to locate the gcode of the item you want to print and select it. You can only select one gcode for printing, if multiple items are selected, printing cannot be started.
- Press the Start button in the bottom right corner of the screen.
- The printer warms the print head and the build plate to the values specified in gcode.
- Printing starts when the unit reaches the required operating temperature.
- Make sure that you have enough filament for the selected project. The quantity is pre-calculated by CraftWare.
- After the object has been printed, remove the build plate. Printed objects can be removed easily, just bend the flexible build plate. Please note: if the object is still warm, it may bend when removed. To avoid this, please let it cool for a while.

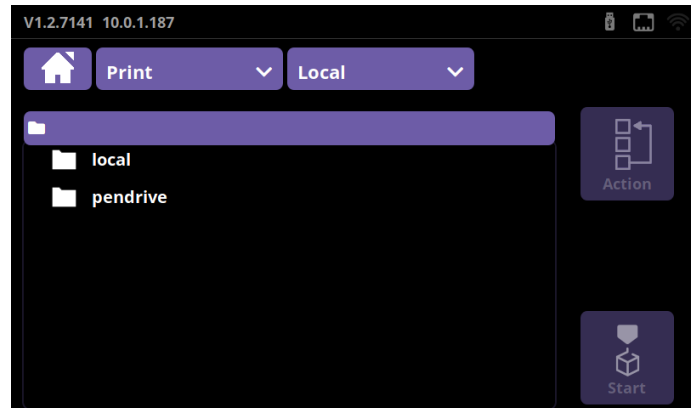

## 5.4. File management

Flow generation machines have a 4GB internal storage for printable items. In the Print menu, you can copy, move or delete one or more items. Copy and move operations are possible between the internal storage and the flash drive, in both directions. You can create a new directory if required.

To access the file actions, press the Action  button.

- To perform a file action, select the file / directory you want to perform the operation on. To enter a directory, short press it. You can select directories by long press on them.
- Select the desired action from the Actions menu.
- Go to the destination directory for file transfer and perform the paste operation. It will copy or move the files / directories to the selected directory.

Please note: the deleted files are not stored in recycle bin and cannot be restored.

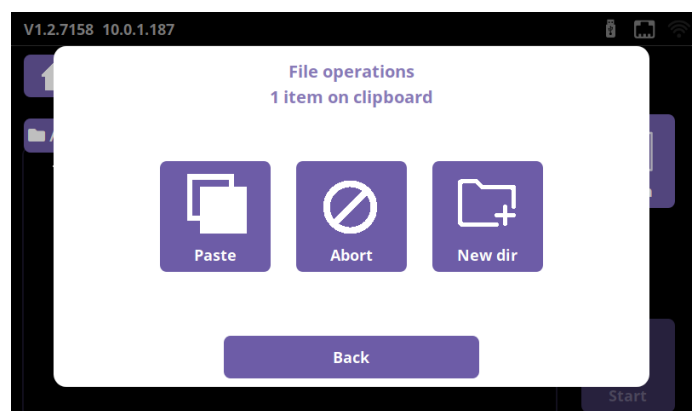
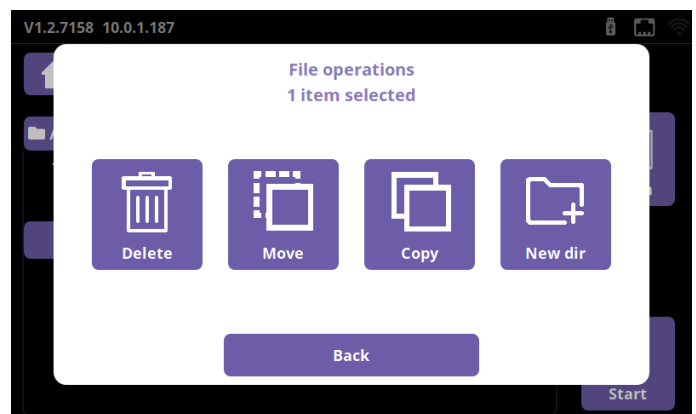



## 5.5. The print menu

Printing starts when the machine has reached the required operating temperature.

The following values are displayed during printing:

1. Name of the file/object to be printed
2. Percentage of total printing completed
3. Current z height/total z height
4. Remaining time (with heating time)
5. Head temperature
6. Filament remaining/ total
7. Bed temperature
8. The number of layers to be created/ total number of layers
9. Print speed

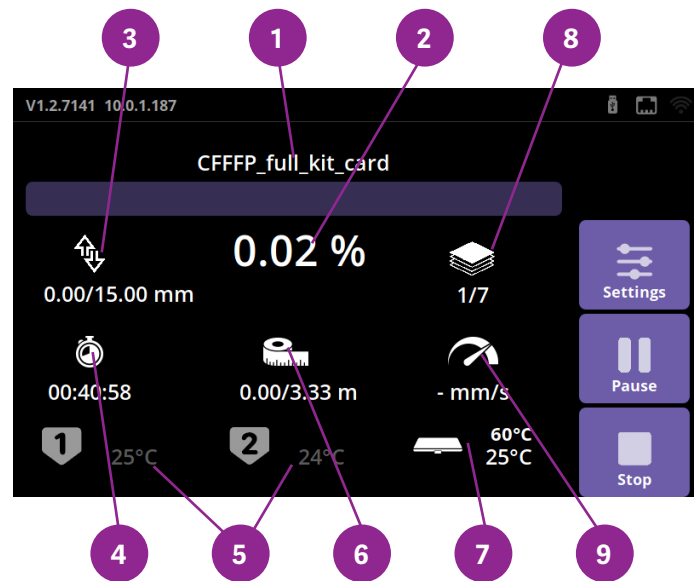

Please make sure that you have enough filament for the selected project. The quantity is precalculated by CraftWare.

After the object has been printed, remove the build plate. Printed objects can be removed easily, just bend the flexi kapton plate.

## 5.6. In-print adjustments / pause menu

During printing, sometimes it can be essential to modify the printing parameters on the fly.

This menu also pops up when the printer gets a pause command from the gcode or from the screen.

In the Pause menu users can change filament, continue printing or terminate the printing operation. Pressing the resume button will continue the print job. For filament change use the Extrude / Reverse functions or the pre-programmed Load / Unload options.

The in-print adjustments overrule the setting is the gcode.

You can change the print settings during printing by pressing the Settings  button on the right icon bar.

The following parameters can be changed:

- Print temperatures
- Extrude
- Fan speed
- Print speed
- Filament flow
- Light
- FMS
- Camera

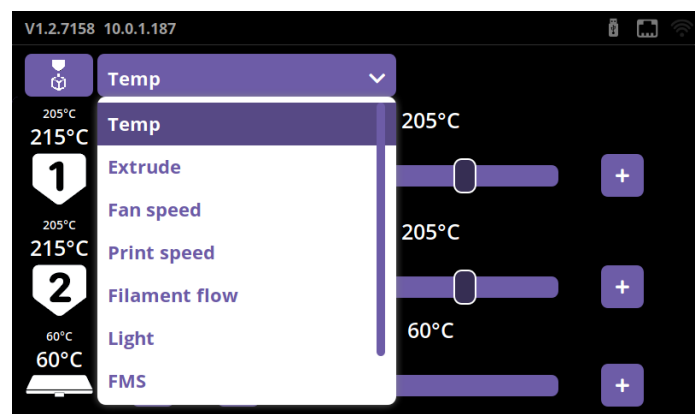

### Temperature

Head and build plate temperatures can be adjusted separately.

Adjust the head and the build plate temperature by touching the slider and the + and - buttons.

You can lock the previously set values if needed.

### Extrude

For filament change use the Extrude / Reverse functions or the preprogrammed Load / Unload options.

### Fan speed

Fan speed volume can be modified in percentage of the original.

You can change the Object fans and the dome fan speeds.

### Print speed

Print speed and extrusion volume can be modified in percentage of the original.

Use the reset button to revert to the values specified in the gcode.

### Filament flow

Filament flow can be modified in percentage of the original.

Use the reset button to revert to the values of the gcode.

### Light

Lights inside the printer and the display back-lighting can be changed.

### FMS

You can enable / disable the FMS functionality and E-mail notifications here.

### Camera

You can enable the time-lapse function if the printing has already started. Here you can choose whether you want to take a picture every 1, 5 or 10 seconds. This parameter does not disable the remote camera access.

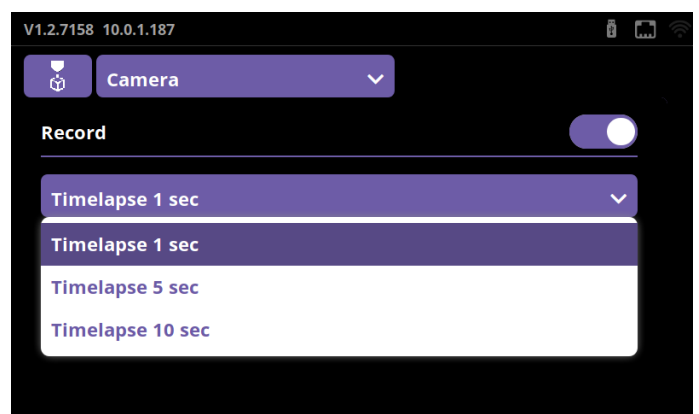
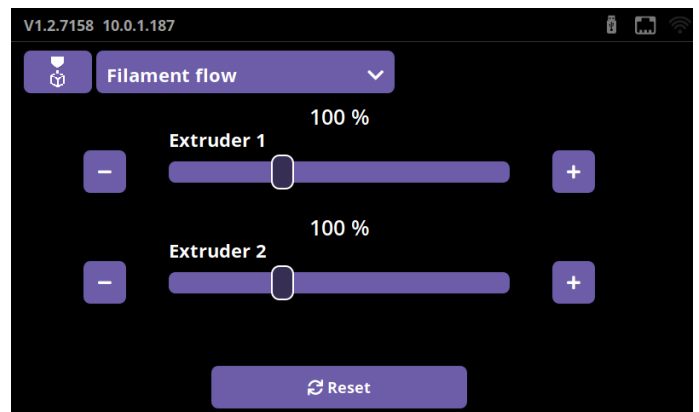
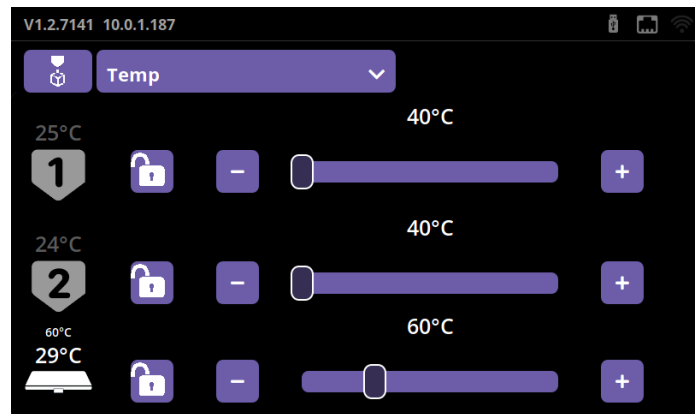

## 5.7. The heating menu

Warming up the head and loading or removing filaments are essential for printing. From the main menu screen, touch the element to be heated (head and build plate icons), which will warm up to the predefined temperature.

If you want to change the heating values, follow the instructions below.

In the main menu, press the Heating  icon.

In the upper part of the new window you can select the desired material (ABS, PLA, PETG...) from the drop-down list.

If you want to print a material with different temperature values, you can change the values by selecting USER1 or USER2. Adjust the sliders or the + and - marks to set the desired values for the head or build plate.

In the Heating menu you can switch the heating on or off by touching the element (head, build plate) icons.

Allowed temperatures:

- Head temperature: 40-300 °C
- Build plate temperature range: 40-110 °C

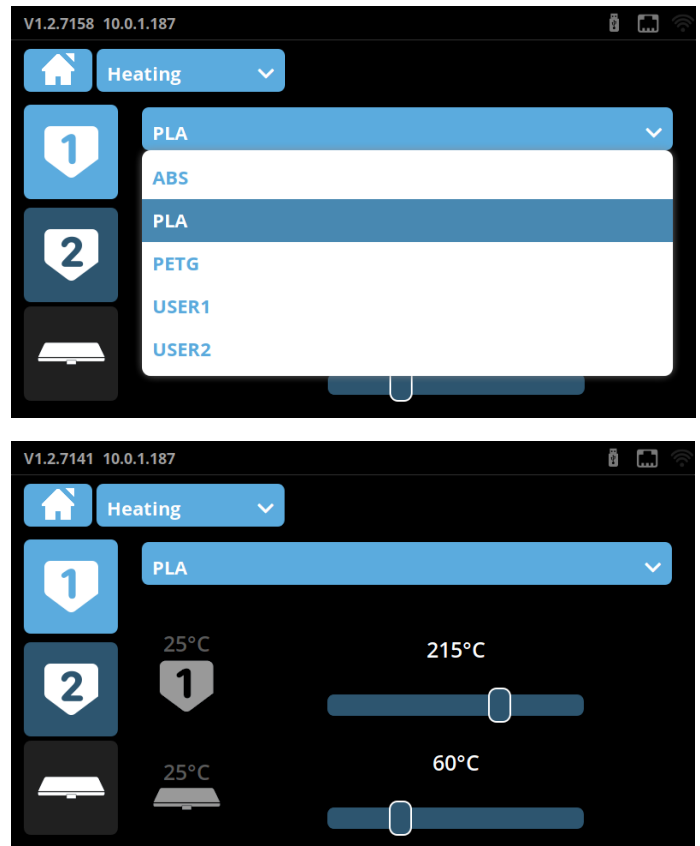

## 5.7. The extrude menu

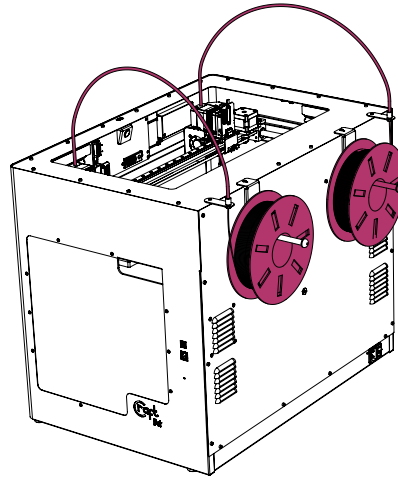
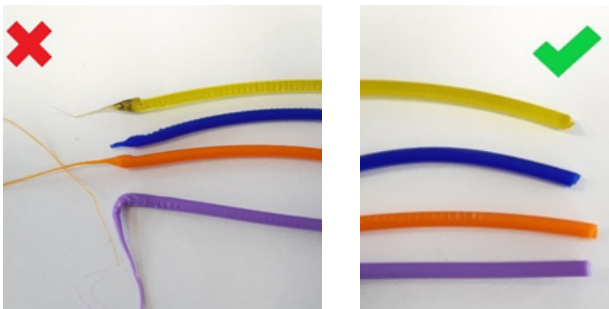

Heat up the extruder where you want to insert the filament into.

- Take the end of the filament out of the securing hole on the Filament spool.
- Cut the end of the filament so the filament is straight and has no damage, bends kinks or melted parts.
- Remove the filament guide tube from the insert hole on the top of the extruder.
- Insert the end of the filament from the spool UP into the filament guide tube holder, then into the filament guide tube. Pass the filament through the tube until it protrudes on the extruder side of the tube.
- Push the filament into the top of extruder hole.



Select the Extrude  menu on the Home screen.

Before extruding, make sure the head is next to the build plate, not pressed into the plate or directly above it.

- To extrude filament from the print head, use the down arrow  on the touch screen.
- Press and hold the button to keep extruding filament from of the head.
- Automatic filament feed can also be performed by pressing the Load  button on the bottom bar. By pressing the button once, the head automatically extrudes some filament.
- Filament loading is successful when the melted filament flows through the nozzle evenly and vertically.



Caution! The freshly spilled melted filament is hot. Avoid contact with spilled filaments or other flammable materials in the nearby.

## 5.9. Unloading the filament

Never remove the filament from the extruder if the extruder is cold!

Always preheat the extruder before removing or changing filaments. Removing the filament from a cold extruder might damage the extruder!

You don't have to remove the filament between prints.



- Heat the extruder as described above.
- Make sure the head is next to the build plate, not pressed into the plate or directly above.
- When the extruder reaches the temperature required for the filament, press the down  arrow, then the up  arrow.
- Automatic filament unloading can also be performed by pressing the Unload  button.
- When the gears start to retract the filament, you can safely pull out the rest of the filament from the guide tube and connect the end of the filament to the spool for safekeeping. Now you are ready to load some new filament.

## 5.10. Changing filaments

- When changing filaments, note that different filaments, such as PLA, ABS, and PET, have different temperature characteristics.
- If you want to replace a material with a higher temperature (eg. ABS, PETG) with a material with a lower temperature (PLA), you will need to heat the head to a higher temperature so that the previous material can leave the head completely before the other filament can its place.
- When changing colors, always push more material out of the head, ensuring that the replaced color is completely removed from the head. During printing, it may be a nuisance to notice that the print color is still blending with the previous color, for example, when changing from red filament to white.



## 5.11. The axes menu

The small house icon  indicates the „home“ position of the extruder, which is the position in the front left corner of the build plate. You can reset the extruder and the build plate to the “home” or “zero” position.

You can either set each axis one at a time (X , Y  or Z ) , or do all three of them at once by touching the appropriate button. If the individual house icons are white, then this means that the motors of each highlighted icon are engaged (working).

To disengage the motors, click on the icon in the bottom right corner , and you will see all of the house icons turn grey. The motors have now been disengaged (not working) and you can freely move the extruder by hand if you wish to do so.

The left control panel controls the extruder along the X and Y axes. You can move the motors that have the house icon filled in. You can control the extruder by dragging the center button in one direction from the center to the outside. The head will move in the same direction.

You can use the up  and down  arrows to move the build plate when the Z house icon is full.

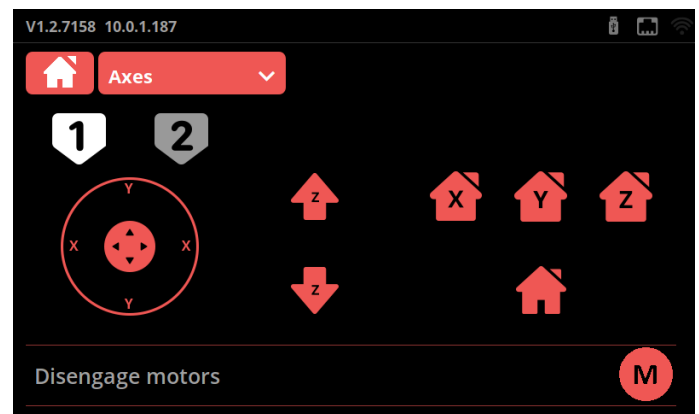

## 5.11. The info menu

Select the Info menu  on the Home screen.

You can see some important infos:

- Model type
- Pr3dator (Mainboard) version
- HMI (LCD board) version
- Language file version
- Gui lib

If you want to restart your printer press the Restart button and the printer will restart.

If you select the factory reset option, the printer will reset some important information:

- Mode
- FMS sensitivity
- Nozzle diameter
- Language (English)
- Time zone
- Sounds
- Personalise
- Host name
- Ethernet-DHCT
- WiFi password
- Web name and password

After a factory reset the values of the following settings will not be cleared:

- Calibration
- Printing files

Inside the Info menu there are 3 other pages.

### Operation counters

Work time: The time since the last reset

Total work time: The time from commissioning

### Report

If you have some problems with your printer, save the report information and send it to our support team.

### Tutorials

You can find some useful information and videos here.

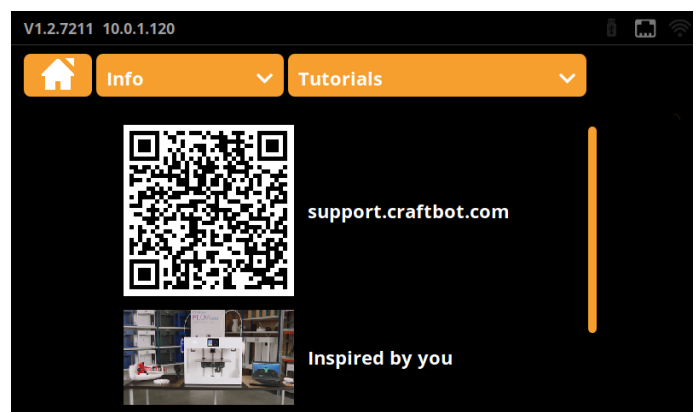
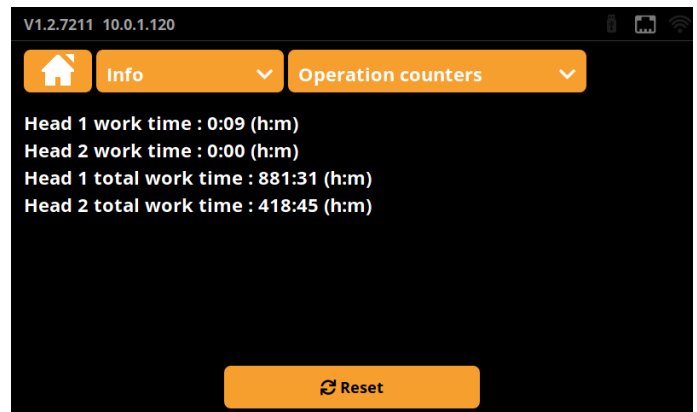
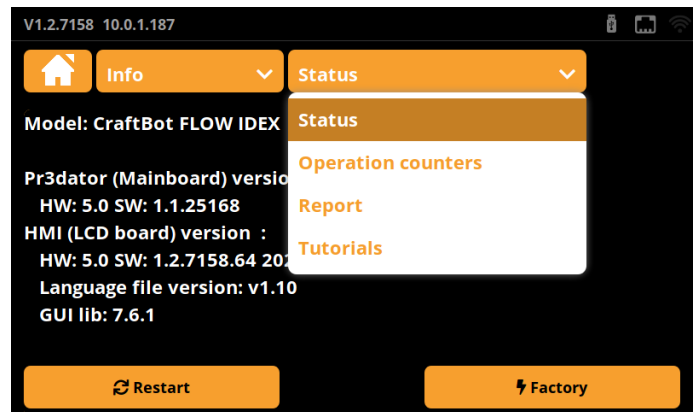

## 5.13. The settings menu

Select the Settings menu  on the Home screen.

Items of the Settings menu:

- Printer wizard
- Calibrate wizard
- Calibrate
- Update
- Language
- Personalise
- Network
- E-mail
- Time zone
- Camera
- Mode
- FMS
- Sound
- Light
- Fan
- Door
- Nozzle

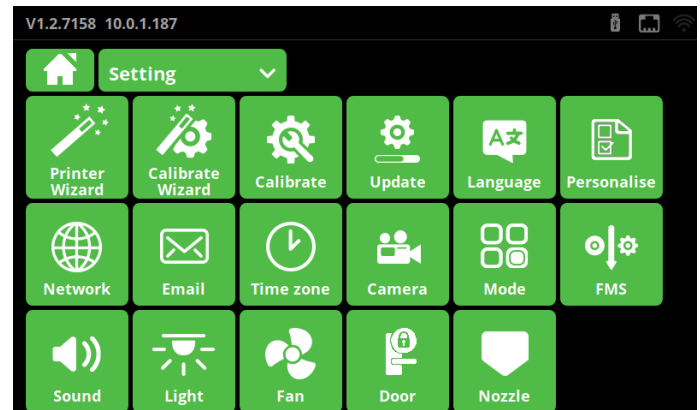

### The printer wizard

This was the first wizard process when you turned on the printer for the first time.

It contains the following settings:

- Language
- Time zone
- Firmware update
- Network (LAN/Wi-Fi)
- Calibration

### Calibration wizard

This is a calibration process. It contains all types of calibration:

- Offset calibration
- Assisted bed calibration
- Mesh bed leveling
- FMS calibration

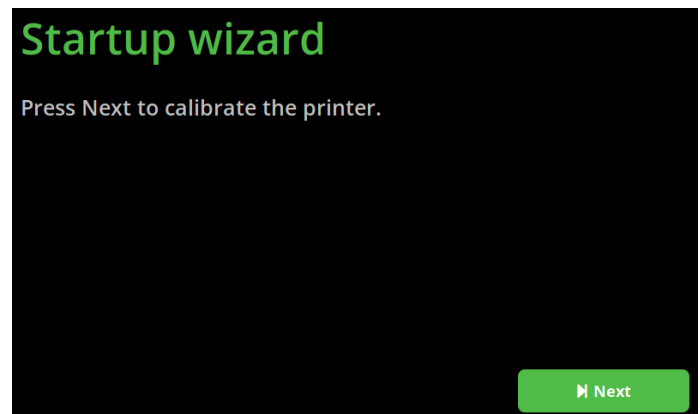



## Calibration

You need to calibrate your printer regularly to ensure that you can always print in good quality and achieve good adhesion to the build plate. There are a total of 4 calibration processes that ensure perfect print quality.

There are a few important rules to follow before calibrating:

- ! Heat up the nozzle and remove the filament from the extruder.
- ! Clean the plate and the nozzle tip.
- ! Make sure the metal plate is pushed back as far as it will go.

To perform the calibration please follow these steps:

- Select the Settings  menu on the LCD screen and touch the Calibrate  icon
- Select which calibration process you want to perform
- Press Start

### Offset calibration

The offset calibration requires manual adjustment on the printer.

Please prepare the 2.5mm hex wrench supplied with your printer

This process will calibrate the following parameters:

**Z limit distance:** Required to resume a print job.

**BL-Touch - nozzle offset:** Required for the assisted bed and mesh bed leveling.

**Extruder 1 and Extruder 2 X-Y offsets:** Required for dual mode prints.

**Extruder Z offset:** Required for dual mode prints, to ensure that the heads are on the same Z level.

This adjustment requires the following user interventions:

- The build plate moves downwards and moves the right head over the build plate and stops.
- Loosen the two screws on the left side of the heat-sink through the gap between the fan grilles and allow the nozzle to move down. If necessary, press down the heat block with the hex wrench.
- Press the Next button. The build plate will now press up the loosened Extruder 2 to the proper height.
- Tighten both screws and press Next to continue calibration.

If the alignment is as it should be, the calibration process will continue and no further intervention is required.

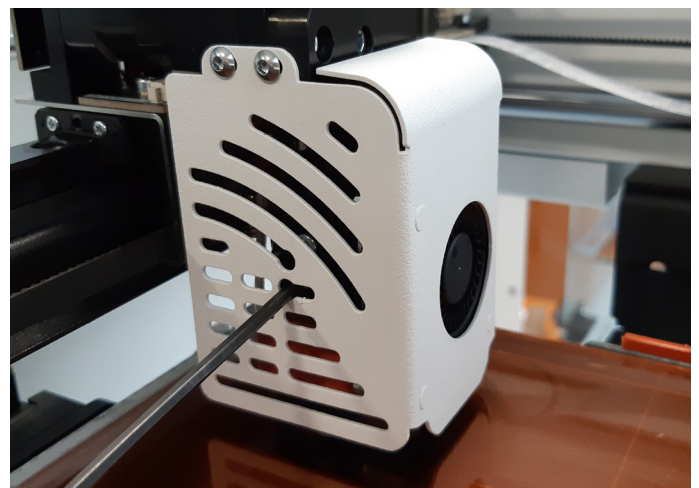
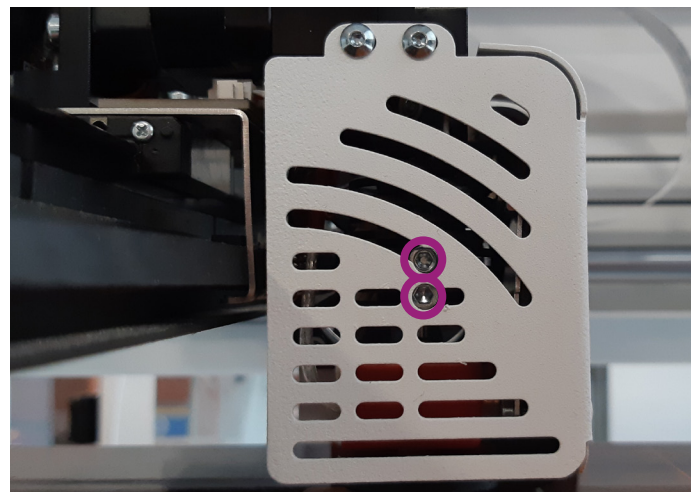
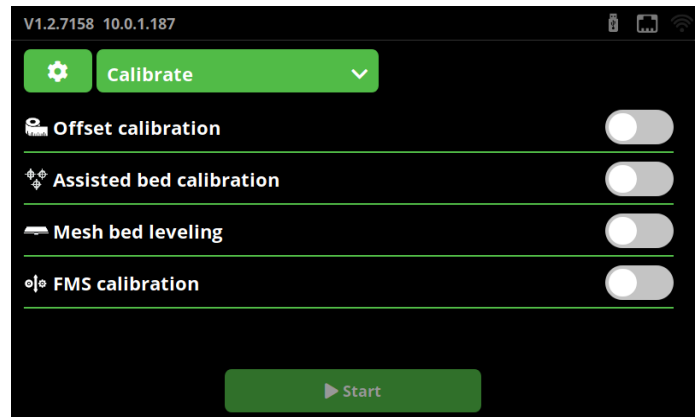



### Assisted bed calibration

Adjusts the parallelity of the build plate and XY mechanics, and also the distance between the nozzle and the build plate.

Assisted bed calibration requires you to manually adjust the build plate. It will be adjusted using the 3 knob screws at the bottom of the build plate. There is one knob at the front in the middle and two in at the back, in the left and right corners of the build plate.

When the process starts, the printer measures the distance between the build plate and the nozzle tip using the BL-Touch sensor. If the distance or parallelity are not optimal, the calibration will begin.

The print head begins to measure at the front centre. At the bottom of the screen you can see the scale of the deviation.

If the deviation is large, the markings are dense. The arrows below the markings indicate which direction the knob should be turned to achieve optimum adjustment.

To achieve optimum value, the meter should be between two prominent lines.

If the measurement is correct, the Next button appears. By pressing the button the printer will proceed to the next measurement point. Once all three measurements have been completed, the printer will re-check the distances.

If all is well, the measurement process is complete.

### Mesh bed leveling

This process creates a map of the build plate and compensates for any surface inequalities while printing the first few layers.

For this calibration no user intervention is required.

During the process the printer measures the build plate at 3 different temperatures: 60°C, 80°C, 100°C

This process takes 15 minutes to complete.

### FMS calibration

This calibration is measures the Filament Monitoring System (FMS) sensor values, and adjusts them if necessary.

For this calibration no user intervention is required.

**Please make sure that filament is loaded into the head you want to calibrate before starting the process.**

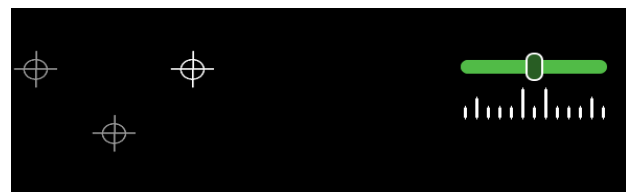
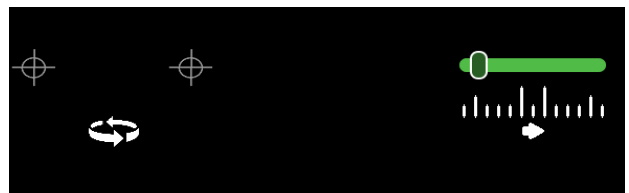
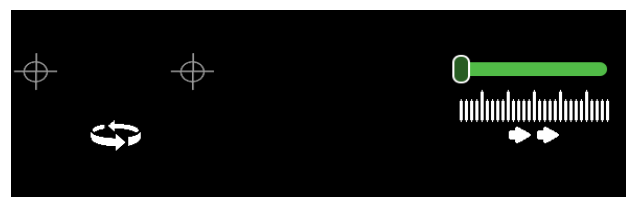
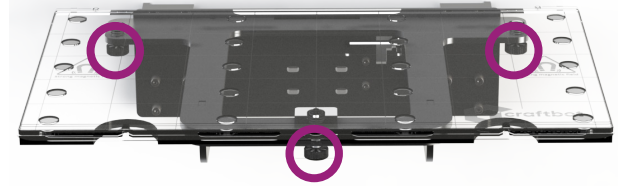

### Firmware update

Craftbot FLOW printers are able to update their firmware through the Internet or from a flash drive. We are continuously improving the features of our printers for the best user experience.



If the printer is connected to the Internet and the update reminder function is enabled, the printer warns you when a new firmware is available.

If the printer is connected to the Internet but the update reminder function is disabled, the printer needs to be updated via the Update menu.

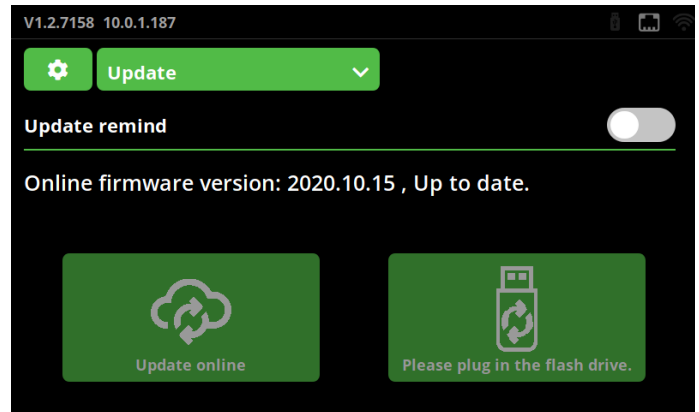
If the printer is not connected to the Internet, please follow these steps:



### Windows and Linux users



1. Download the latest Firmware for the FLOW 3D printers at <https://craftbot.com/firmware>
2. Copy CRAFT\_UPDATE.ZIP to a FAT32 formatted pendrive
3. Plug the pendrive into the HMI port
4. Wait for the pendrive icon to appear on the top right corner of the screen
5. Go to SETTINGS  and then UPDATE  menu
6. Press the RESCAN button until UPDATE FROM PENDRIVE appears
7. Tap the UPDATE FROM PENDRIVE to start the update process
8. Update is automatic, when it is ready, click on the UPDATE FINISHED OK button.

### MAC users

Please ensure you have disabled the automatic extraction of ZIP files in your SAFARI browser.

This guide shows how to disable the ZIP file extraction:

<https://macreports.com/how-to-download-zip-files-without-unzipping/>

1. Download the latest firmware for the FLOW 3D printers at <https://craftbot.com/firmware>
2. Copy CRAFT\_UPDATE.ZIP to a FAT32 formatted pendrive
3. Plug the pendrive into the HMI port
4. Wait for the pendrive icon to appear on the top right corner of the screen
5. Go to SETTINGS  and then UPDATE  menu
6. Press the RESCAN button until UPDATE FROM PENDRIVE appears
7. Tap the UPDATE FROM PENDRIVE to start the update process
8. Update is automatic, when it is ready, click on the UPDATE FINISHED OK button.

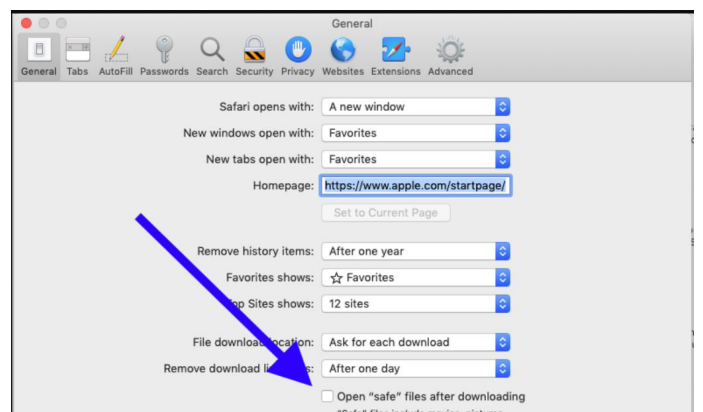
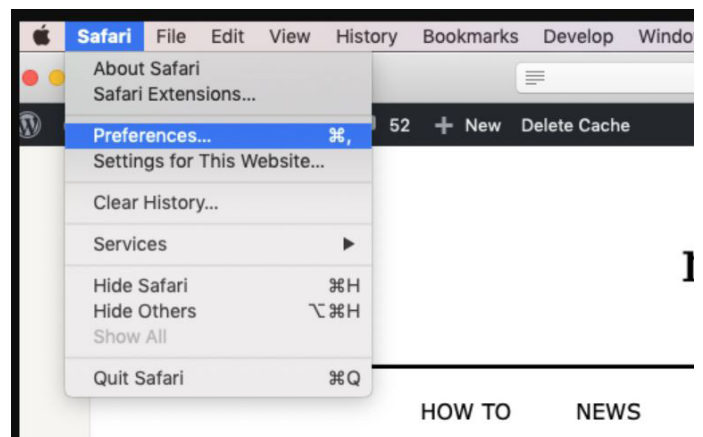

### Troubleshooting:

If the FW update runs into an error, please do the following:

1. Turn off the printer
2. With a piece of filament push and hold the reset button (a little hole under the Ethernet port)
3. Turn on the printer
4. Release the button
5. Install the FW as above

Please do not interrupt the process or unplug the printer during the firmware update.

The update process takes about 3 minutes.

### Language

- Select your language from the list (EN, DE, HU, NL, FR, ES, IT)

### Personalise

You can personalise your printer. There are several options:

- Which side would you like the head position to be at pause?
- Would you like the machine to go to XY reference at the print finished?
- Would you like the machine to go to XY reference at the print terminated?
- Would you like the bed to move down when the print finished?
- Would you like to extrude when the hotend is cold?
- Warning before homing or jogging to check the build plate for any objects.
- Would you like the machine to check the buildplate is present?
- Would you like the machine go to the pause position\ nif you open the door while printing?
- Would you like the machine measure print bed level\ nbefore you starting print?
- Would you like to switch to expert calibration mode?

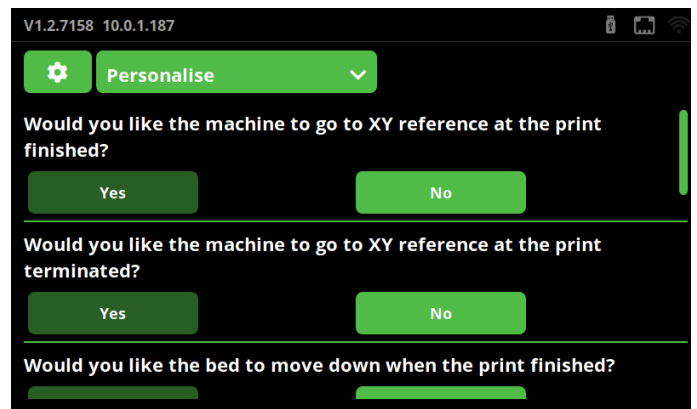
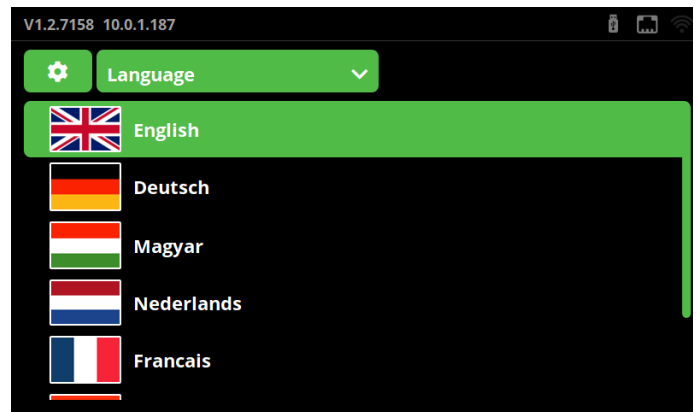

## Network

Select the Settings menu  on the LCD screen and touch the Network  icon.

On the main page you can see some information about the network:

- IP address
- Subnet mask
- Gateway
- DNS
- Hostname
- MAC

Select the Ethernet or the WiFi network. The printer can be either on Ethernet or WiFi. If you select the WiFi option the printer will turn off Ethernet and vice versa. You can choose Static IP or DHCP. If DHCP is selected, the printers must be configured.

## WiFi

If you selected the WiFi option please go to the WiFi menu on the top of the screen.

The Searching button will list WiFi resources. Select a suitable one and if you have a password you can enter it using the keyboard shortcut.

## Web config

Here you can reset your username and your password for the web platform.

USERNAME: admin

PASSWORD: adminadmin

## E-mail

Craftbot FLOW Generation printers can send an E-mail notification if a problem occurred during the print job.

For the E-mail notification to work you have to set up an E-mail account for sending.

We recommend you use GMAIL. Register an E-mail account on GMAIL and use its settings for sending notifications.

Please read this article on how to create a GMAIL account:

<https://support.google.com/mail/answer/56256?hl=en>

Please allow access to the GMAIL account for "Less secure Apps" as follows:

<https://support.google.com/a/answer/6260879?hl=en>

The FROM: E-mail address should be your new GMAIL address you just registered.

The TO: email address is the E-mail address where the printer will send the notification messages.

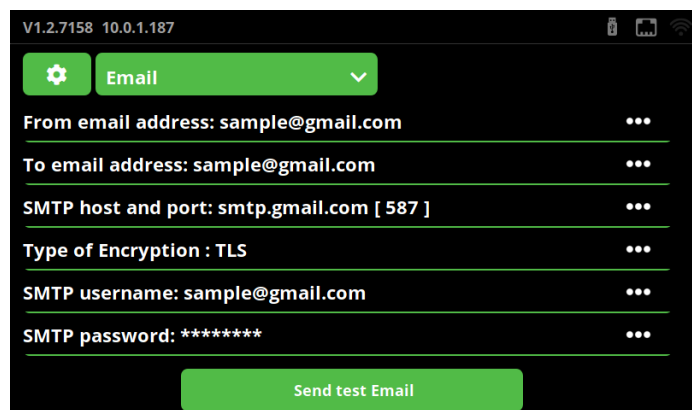
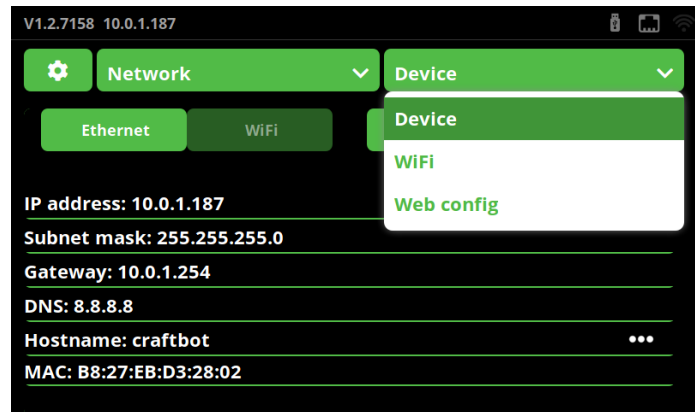

SMTP username: the GMAIL address you just registered  
SMTP password: the password you used when you registered the new GMAIL address.

After you have entered the settings in, please click on "Send test Email" and you will get a sample E-mail to E-mail inbox you have just set up.

### Time zone

Select the Settings menu  on the LCD screen and touch the Time zone  icon.

Select your time zone from the list and turn on automatic time setting.

If you want to set the time yourself then turn the off automatic time setting and select the time from the Date/Time lists.

### Camera

You can enable the time-lapse function for a print job that has already started. You can have a photo taken every 1, 5 or 10 seconds. This parameter does not disable the remote camera access.

### Printing modes

This printer has only one head, so you cannot change the printing mode.

To adjust the print mode, select the Settings menu on the LCD screen and touch the Mode icon.

**Default mode:** Gcode will determine whether the printer operates with one or two print-heads.

**Mirrored printing:** If an object fits on half of the build platform, then there is the option to print two objects at once which will be mirror images of one another. This way, two objects can be made in the time it takes to print one object. For example, if printing a hand, the printer can make a right and a left hand at the same time. If a symmetrical object is being created (a heart, for example), both halves can be printed at once and the entire object can be prepared in the time it takes to print half an object.

**Parallel printing:** If an object fits on half of the build platform, there is the option of printing two objects at once that will be completely identical. This way, two objects can be made in the time it takes to print one object. This doubles the printer's productivity.

**Inverted head:** It swaps the 2 heads while printing. A part what should be printed with the first head it will be printed with the second head and vice versa. You do not have to replace the two filaments at the beginning of the print if they are swapped in the two heads.

**Backup:** This option can be used when you print with 1 head. While printing, if the first head jams or runs out of filament, the second head will continue automatically thus the print job will not be interrupted. When using this mode it is recommended that you use the same material type (or at least the same color) in both heads to ensure the uniformity of the final printed model.

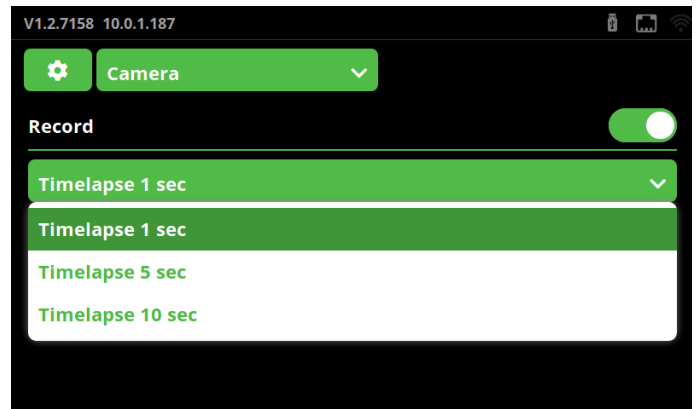
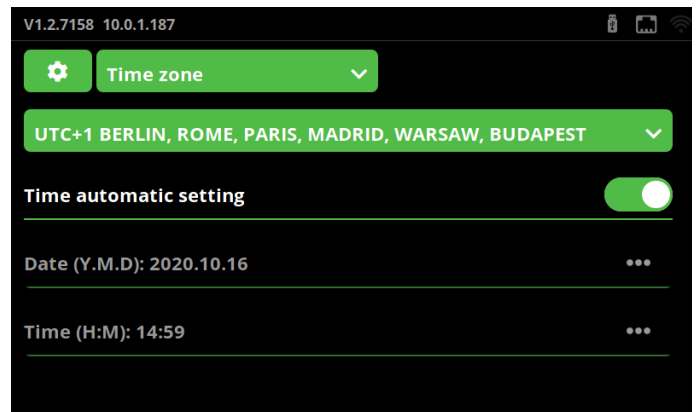

### FMS

You can change the FMS sensitivity of Head 1 and Head 2.

Select the Other settings menu and turn on or off the FMS E-mail system. If a filament jam is detected while printing, the system will send a notification to your configured E-mail address.

### Sound

You can change the sounds of printer. You can separately enable Event sounds and Button sounds.

Use the reset button to change back to the factory values.

Inside the Event sounds menu you can choose from 20 ringtones for different printer statuses. **Light**

There are two types of lights:

- Interion LED lighting
- LCD display backlight

Move the slider from left to right to adjust the brightness of the light.

### Logo color

Here you can adjust the color of the backlight of the Craftbot logo on the printer.

You can assign four statuses to the logo light:

- Stand by
- Error
- Printing
- Success

### Fan

Multiple sliders are displayed on the new screen to control the power of the fans.

There are 4 type of fans:

- Object fan
- Extruder fan
- Case fan
- Dome fan

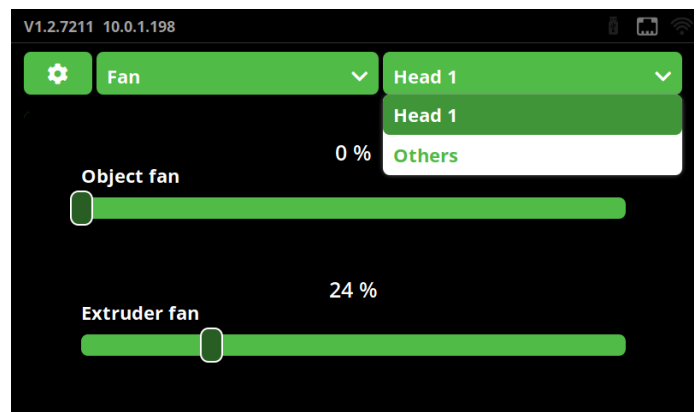
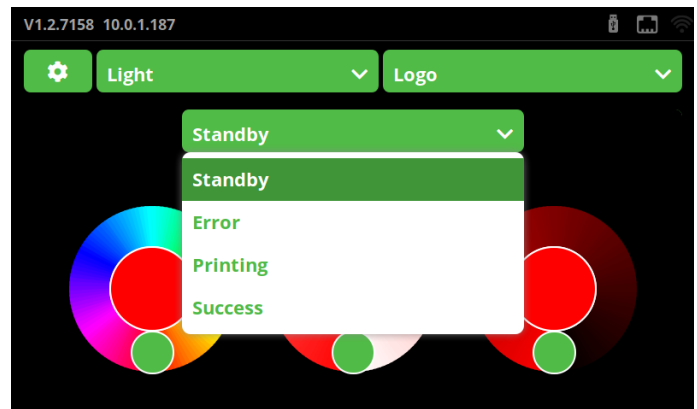
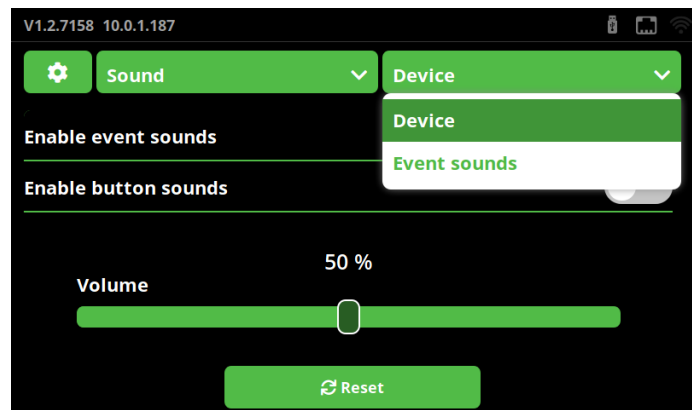
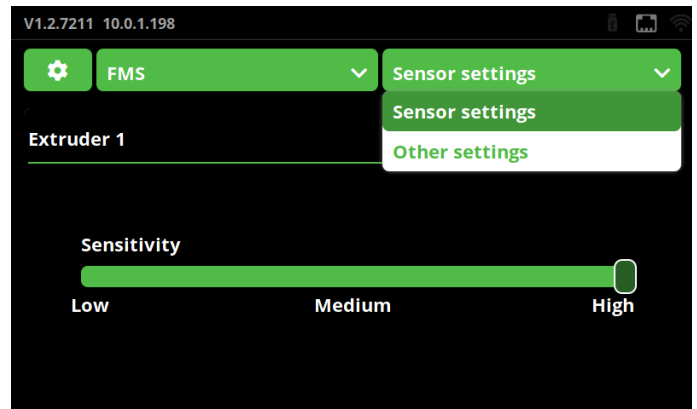

## Door

If you have a door for your printer turn on the Door and select the threshold temperature (40 °C or 60 °C).

For safety reasons, the system does not allow the opening of the door if the temperature is higher than this threshold.

## Nozzle

Select the diameter of the Nozzle from the list.

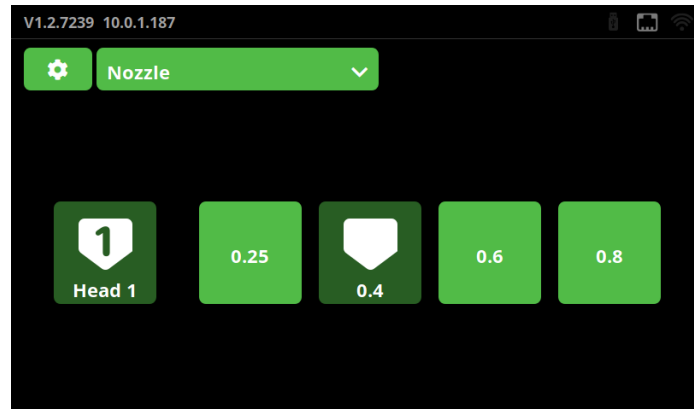
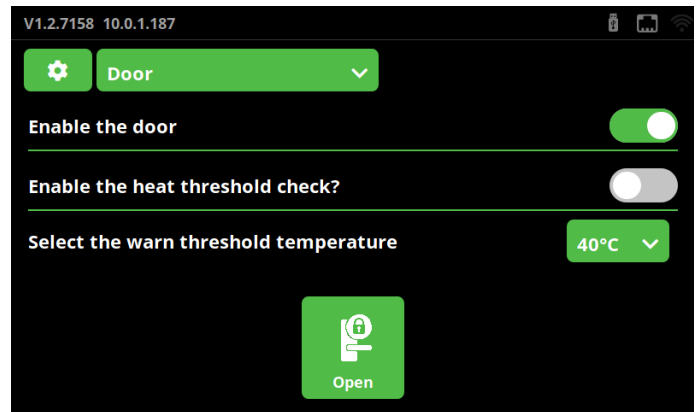

## 6. USING THE WEB INTERFACE

### 6.1. Login

If you have already configured your printer for network use, its IP address can be found on the main screen.

When you first log in, enter the IP address of your printer in the web browser, eg.: `http://10.0.1.21/`

Log in to the site with the default username and password:

- Username: admin
- Password: adminadmin

After you have logged in you may be asked to change the generic username and password.

Username: Minimum 5 characters, alphanumeric characters only

Password: Minimum 6 characters, alphanumeric characters only

### 6.2. Main menu

After logging in, the Dashboard of the web interface opens.

Here we can track the print data.

You can start, restart, pause, or stop printing in the horizontal top action bar.

Below you can see the current status of the printer and the head and the print tray heating data.

On the left you can see the sub-menus. These are used to configure the printer before printing. After you have started the print job some of the menus will be inactive, such as extrude, temperature.

### 6.3. Uploading files through the WEB interface

In the File manager menu you can drag and drop or upload gcode files in the conventional way.

Please note, only gcode files are allowed. If you have an .stl file, you will need to slice it first.

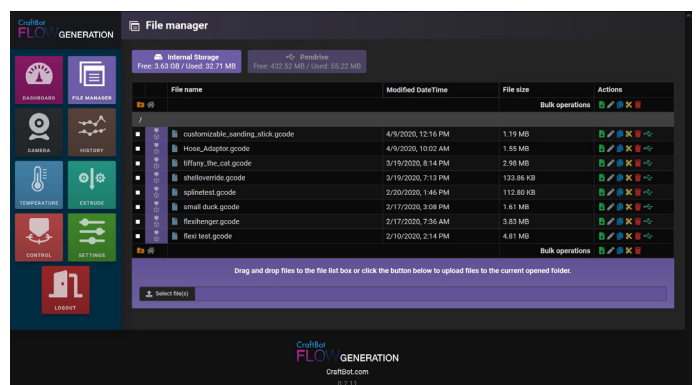
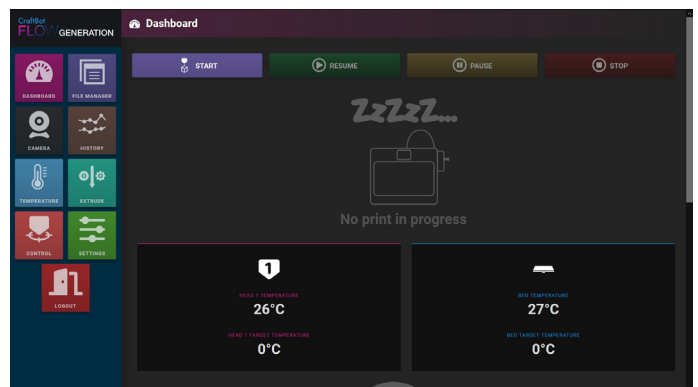
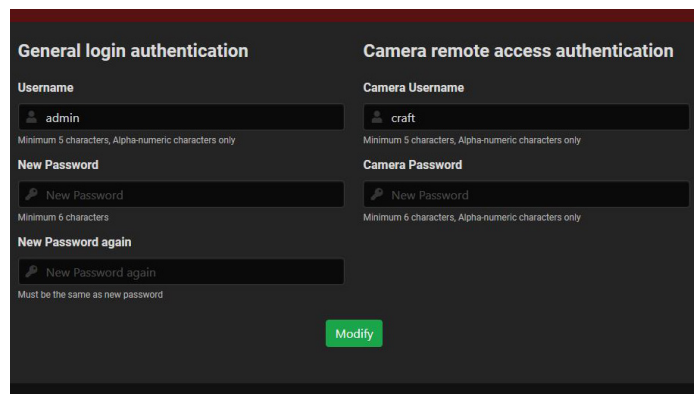
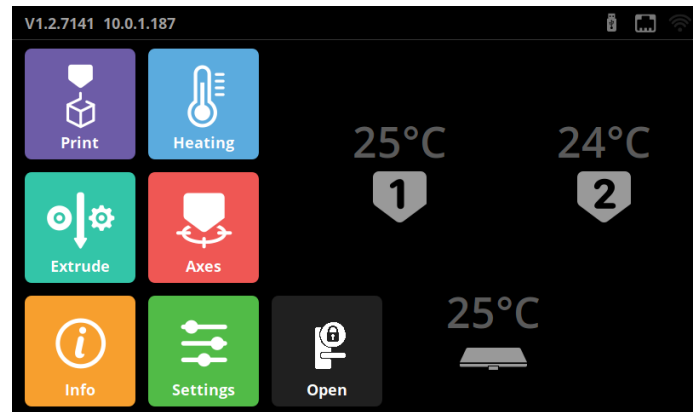



## 6.4. Printing objects through the WEB interface

In the File manager you can see the available gcode files. You can print gcode files either from the internal storage or from the flash drive.

Press the Print icon next to the file you want to print.

Confirm your choices with the pop-up messages and the print job will start.

You can follow the print process on the dashboard. The print bar shows the progress in percentage.

While printing is in progress, the Dashboard will change as follows:

- The Temperature and Extrude menus are deactivated. After printing, these menus will be active again.
- The Pause and Stop buttons are activated.
- The print bar shows progress in percentage
- Use the temperature chart to keep track of head and tray temperatures. Data is updated every second.

## 6.5. Web interface settings

### Camera

You can see the current camera image on the screen so you can keep track of your print job.

You can take snapshots of the image or make a video of the printing process.

### Temperature

You can adjust the temperature of the individual heads and tray or pre-heat them according to the material.

### Extrude

From the Extrude menu, you can remotely extrude the filament from the head when the head is heated.

### Control

When you enter the Control menu, you will see the Home buttons and the x, y and z movement buttons already described above.

You can even monitor the movement of your printer through the camera.

### Other settings

### Lights

Similarly to the printer's built-in menu, you can set up the printer lights here:

- Backlight
- Intensity of the LED screen illumination,
- and adjusting the background colors of the logo in different statuses.

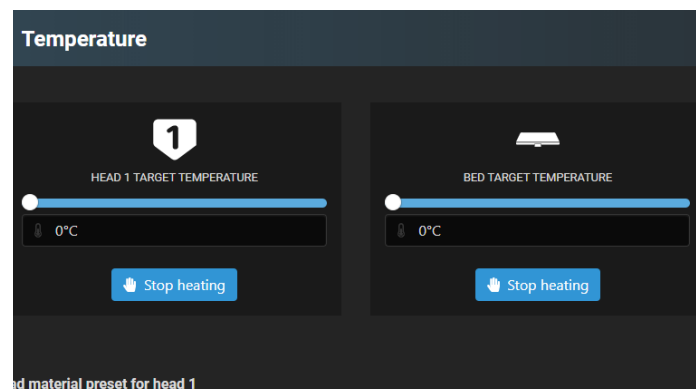

### Network

Configure static IP or DHCP. If static IP is selected, the data must be entered manually here.

### Accessories

The properties of the printer accessories can be set here, such as door and shroud fan.

You can also specify the size of the nozzle here.

- Notifications
- E-mail address,
- Password
- Server address

to ensure that if you run out of filament or encounter other issues while printing, you will be notified at the E-mail address you provided.

### Preset

Preheat values can be set for the head and the print tray, separately for different materials.

### Sounds

Turn system sounds on or off and adjust the volume.

### Locale

You can change the unit of temperature and the language.

### Login info

You can change your username and the associated password.

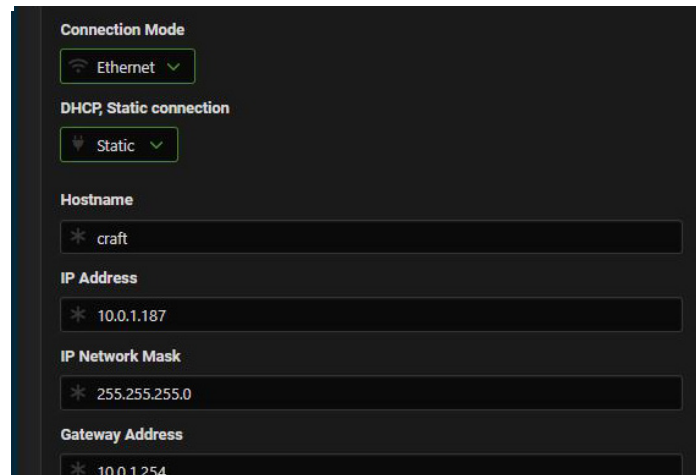

## 6.6. Watching the camera image remotely

Craftbot Flow printers are equipped with a built-in camera. This allows the user to view the print progress, spot failures and control the printer remotely.

To access the camera please login to the web interface and enter the Camera menu. You can take snapshots of the image or make a video of the print job.

You can access the camera stream directly at <http://<printer ip address>/camera>.

The stream is only accessible with the camera username and password. The camera has its separate username and password. This allows you to share the camera with operators without revealing the user interface credentials.

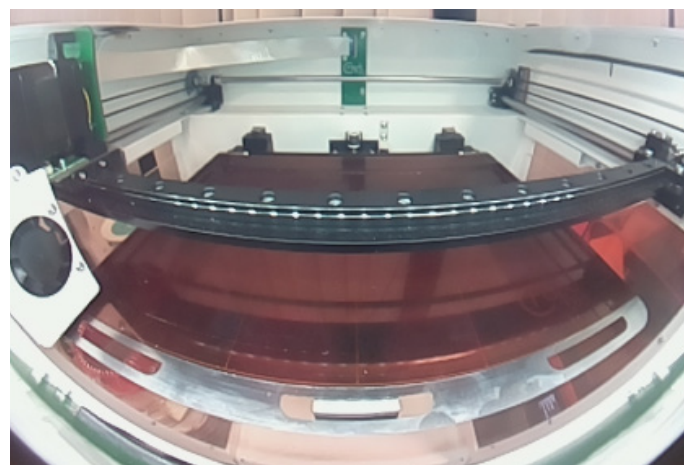

## 7. CLEANING AND MAINTENANCE

### IMPORTANT!

Cleaning and lubrication should only be performed while the extruder and build plate are cold. Please allow the Craftbot 3D printer to cool at least 30 minutes before cleaning or maintenance. The printer needs to be cleaned after every 1000 hours of operation. After every 1000 hours you will need to change the used and worn parts of the unit. The printer will warn the user.

### 7.1. Cleaning

Clean the metal housing of the Craftbot by wiping it with a damp cloth.

Clean the build plate with window cleaner or Acetone. Wipe clean with a dry cloth or paper towel.

### 7.2. Lubricating

The Craftbot printer should be lubricated at least once after every 50 hours of use or every 6 months.

Tools needed for lubrication:

- PTFE based lubricant spray or grease
  - 2 separate lint-free rags or thick and strong paper towels
  - Personal protection such as gloves and safety glasses/goggles
  - Light source (e.g. a torch) to illuminate the interior of the unit
1. Move the build plate and the extruder to the „Home“ position.
  2. Once the extruder and bed are in the home position, turn the Craftbot printer off and unplug it from the power supply.
  3. If you look under the build plate you will see three rods that run vertically on which the build platform moves up and down. The two outside rods are smooth and the center rod is threaded. These three rods are known as the “Z-axis rods”.
  4. Place a folded paper towel or a lint-free rag behind the center rod. This rag is used to protect other areas of the printer from any over-spray that may occur.
  5. LUBRICATE ONLY THE PARTS RECOMMENDED IN THIS MANUAL!
  6. Spray the threaded Z-axis rod at a relatively close distance to reduce over-spray. Make sure the lubricant reaches the inside of every thread (if using grease, spread with hand wearing gloves).
  7. Make sure not to over-lubricate, spray only the minimum required amount!
  8. Do not spray the other two rods directly! Spray on the towels and use them to wipe the rods.
  9. Remove the rag from the Craftbot interior.
  10. Plug in and power up the printer and move the build plate to the lowest point (go to Axes menu, and press the Z down arrow until the bed reaches the lowest point).
  11. Turn the Craftbot printer off and unplug it from the electrical outlet.
  12. Place a second clean rag on top of the heated build plate to protect the components and the Kapton from any overspray.

13. Repeat the process for the top side of the Z-axis rods the same as you performed on the bottom side: protective rag behind threaded rod, spray, wipe off excess lubricant on other two outside rods.
14. Power up the Craftbot once again and raise the build plate back up to the highest position (set the X, Y and Z to the home position).
15. Turn the Craftbot printer off and unplug it from the power supply.
16. Wipe off any excess lubricant from the bottom side of the Z-axis rods.
17. Power up your Craftbot once again and move the build plate back to the lowest point.
18. Turn the Craftbot printer off and unplug it from the electrical outlet.
19. Wipe off any excess lubricant from the top side of the Z-axis rods.
20. Power up the Craftbot once again and raise the build plate back up to the highest position.
21. Turn the Craftbot printer off and unplug it from the electrical outlet. The motors will now disengage so that you can move the extruders freely by hand.
22. Use an oiled rag to lubricate the X and Y linear rails. Do not spray from above! Move the extruders back and forth by hand to both extremes of the axes. When the extruders move absolutely smoothly you are finished.

## 7.3. Removing clogs from the extruder

The number one inconvenience that you will run across when 3D printing is clogging of the extruder. But we have good news for you! This problem can be easily avoided by following a few simple rules of "3D printing etiquette".

- First, always wait until the extruder is fully heated to its intended temperature before inserting the filament. Inserting the filament at a lower temperature is just asking for a clog.
- Heat up the extruder and then secure the screw on the top of the extruder. Now you can move the filament smoothly. After the process don't forget to loosen this screw again!
- When unloading or changing the filament: always heat up the extruder completely first. Then "Extrude" for 5 seconds and then immediately press "Reverse", helping filament retrieval by pulling a little bit on the filament end coming out of the extruder with your fingers. The "Extrude" operation is necessary because the hotend needs to melt the whole previously melted filament.
- If the extruder is clogged, you will need to clean its passageway. You can use one of the small hex wrenches that came with the Craftbot. To do so, heat up the extruder to 250°C. While the extruder is empty push any excess filament out by plunging the hex wrench down into the passageway: Make sure to do this with sufficient force but not violently to avoid damaging the machine, and always take precautions because the extruder is very hot.
- It is especially important to purge any leftover filament before using a different filament as the different filament's properties (even the same material in a different color) can cause clogs from inconsistencies. For example: you must heat up to 250°C to clear out any extra ABS before using PLA.

Clogging is the most common problem in every 3D printer and cannot be prevented 100%, but if you follow these simple steps you will prevent 95% of all occurrences. If you still cannot clear the passage with just this method, you may want to move onto the next method by following these next steps to actually remove the nozzle itself...

## 7.4. Replacing the fan set

If you have encounter problems because the BL touches intermittently or is not working at all or the fans are not working, then follow the process below to investigate. This could be due to pins breaking or being misaligned due to twisting of the Fan casing.

- Remove the screws on the left and right side with the 2 mm Allen key.
- With one hand, hold the fan assembly steady as you remove the last of the bolts.
- Lower the fan set about one centimeter and then move it forward and away from the Extruder.

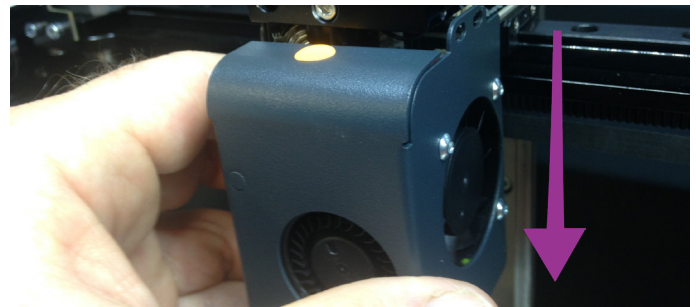
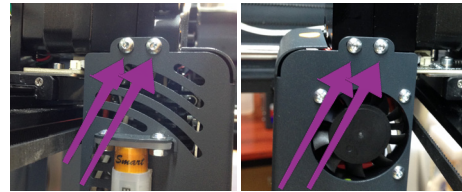

## 7.5. Relocating the fan assembly to the extruder assembly

- Move the fan Assembly over the extruder first about 1 centimeter below the required height. Gently lift the fan assembly to connect to the 2 boards together but first insert the central pin from the Extender board into the hole of the Fan extender board below it.
- When you have inserted the pin into the central hole, align the side bolt holes of the Extruder with the fan casing holes and place an Allen key into the front bolt hole on the right side again to keep it steady.
- Start inserting the first bolt into the rear hole on the right side to hold the correct position, taking some of the stress off the pins.
- Place the second bolt into the front left bolt hole to hold the fan assembly more level and upright on the extruder Assembly. Now use the Allen key to secure all 4 of the bolts that attach the fan set to the extruder assembly.
- Now you have finished disassembling and reassembling the extruder fan set from the extruder assembly.

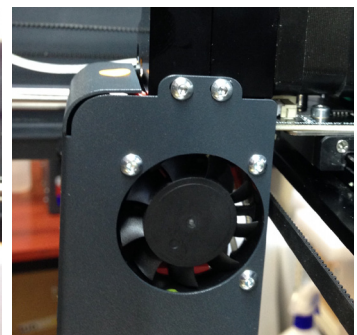
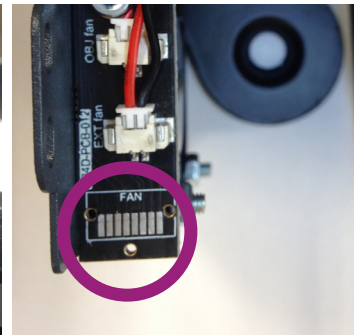
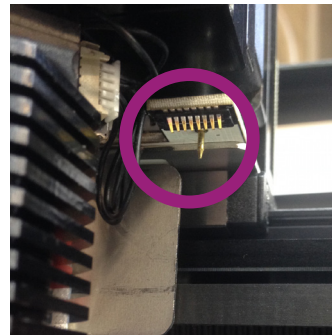

## 7.6. Removing the nozzle

Remove the filament from the head or cut the filament at the point closest to the extruder.

- Remove the head only after it has completely cooled to avoid burns.
- In the Navigation menu, lower the bed level for convenient head access during the process.
- Turn off the printer.
- The fan assembly on the head can be removed using the 2 screws on each side. The fan unit can then be easily removed.
- Loosen the screw on the head at the bottom of the silicone cover, but do not unscrew it. Pull out the heat cartridge and the temperature sensor from the heating block.
- Loosen but do not remove the 2 screws on the left side of the black heat sink.
- This allows the bottom head to be pulled out of the black block.
- Remove the nozzle and the heat-break with wrenches.
- The two parts can now be cleaned comfortably with the Cleaning Kit.
- If you need further clarification please watch this video: <https://youtu.be/I6jRyI02kI0>

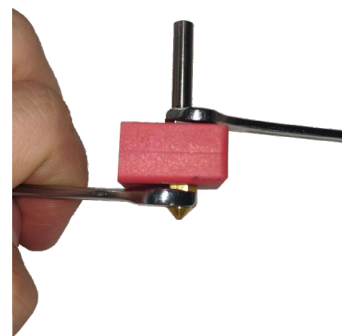
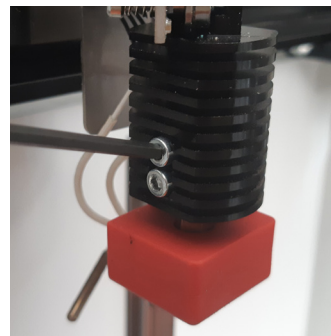
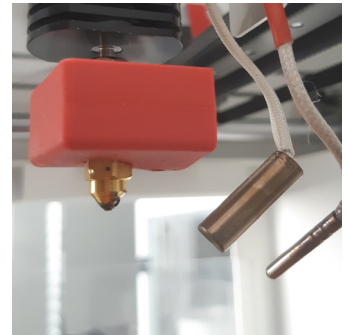

## 7.7. Removing the hotend

Remove the filament from the head or cut the filament at the point closest to the extruder.

- Remove the head only after it has completely cooled to avoid burns.
- In the Navigation menu, lower the bed level for convenient head access during the process.
- Turn off the printer.
- The fan assembly on the head can be removed using the 2 screws on each side. The fan unit can then be easily removed.
- Loosen the screw on the head at the bottom of the silicone cover, but do not unscrew it. Pull out the heat cartridge and temperature sensor from the Heat-block.
- Remove the long screw on the extruder and then you can remove the hotend block.
- If you need further clarification please watch this video: <https://youtu.be/I6jRyI02kI0>

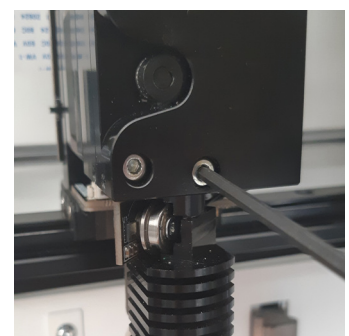
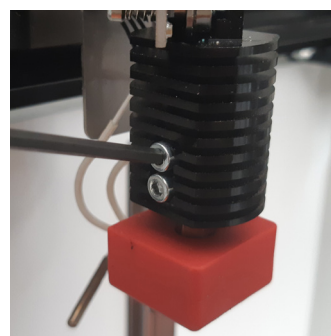
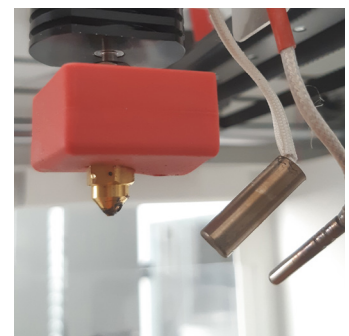

## 7.8. Replace the hotend

Assembly instructions:

1. Items 14 and 15 are placed in block 3 until they stop,
2. Fasten plate part number 5 to part number 3 with screw number 6.
3. Slide item number 4 onto item number 3 until it stops.
4. Wring Nozzle part 1 into block number 3 until it stops.
5. Screw Heatbreak number 2 onto Nozzle number 1 protruding from block 3 until it stops. (Figure 2)
6. Tighten Heatsink No. 8 on part number 2 and secure with screws 7. Make sure that the lower plane of block 8 coincides with the easing of item number 2 and that the two lows are parallel. (Figure 2)
7. Assemble the sensor separately: Use screw 11 to secure item 10 to the FMS sensor 9. (Figure 1)
8. Tighten spring 13 to screw 12 to then secure item 9 to part number 8.
9. In all cases, check under light that no dirt has entered the assembled parts.

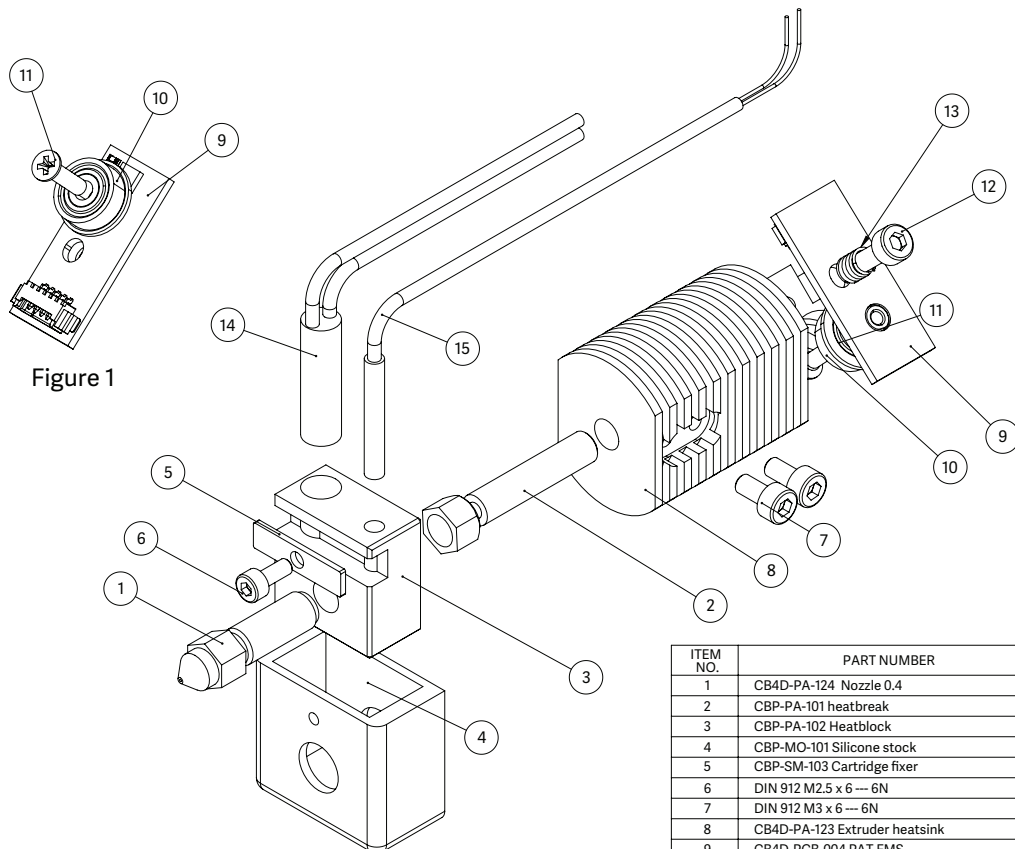
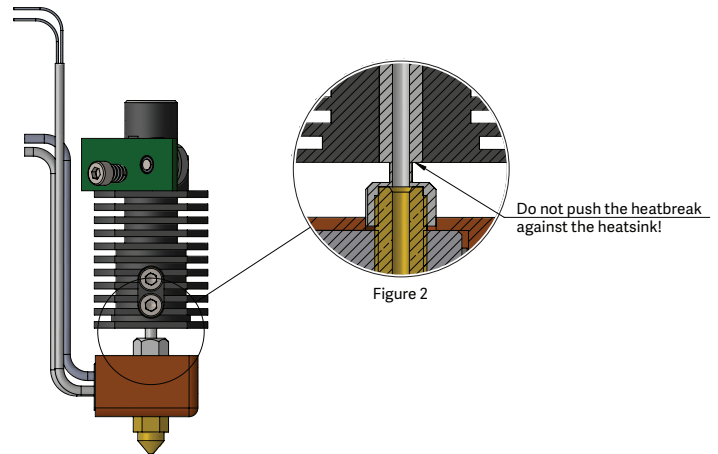

ITEM NO.	PART NUMBER	Name	QTY.
1	CB4D-PA-124 Nozzle 0.4	Nozzle 0.4	1
2	CBP-PA-101 heatbreak	Heatbreak	1
3	CBP-PA-102 Heatblock	Heatblock	1
4	CBP-MO-101 Silicone sock	Silicone sock	1
5	CBP-SM-103 Cartridge fixer	Cartridge fixer	1
6	DIN 912 M2.5 x 6 --- 6N	Screw	1
7	DIN 912 M3 x 6 --- 6N	Screw	2
8	CB4D-PA-123 Extruder heatsink	Extruder heatsink	1
9	CB4D-PCB-004 PAT FMS	PAT FMS	1
10	F623zz	Bearing	1
11	DIN EN ISO 7046-1 - M2.5 x 10 - Z - 10N	Screw	1
12	DIN 912 M3 x 12 --- 12N	Screw	1
13	AC450-4200-6.000-MW-10.000-C-N-MM	Compression Spring	1
14	24V40W Heater Cartridge 105mm cable	24V40W Heater Cartridge 105mm cable	1
15	PT 100 Temperature sensor 105mm length	Temperature sensor 105 mm length	1

## 7.9. Adjusting X belt tension

- Loosen the nut that secures the X-belts through the hole with a 7-gauge wrench provided until the block no longer locks the belts.
- Then tighten the nut.



## 7.10. Battery replacement

- The battery type you need to replace is CR2032.
- Before installing the battery, also remove the screws on the back cover. Be sure to disconnect the fan and hood connection cables from the system board after removing the back cover.
- Remove the depleted battery.
- Before inserting the new battery, turn on the printer. Insert the new battery into the system board.
- As a final step, turn off the printer again, then unplug the power cord and reinstall the back cover as shown in the first step.

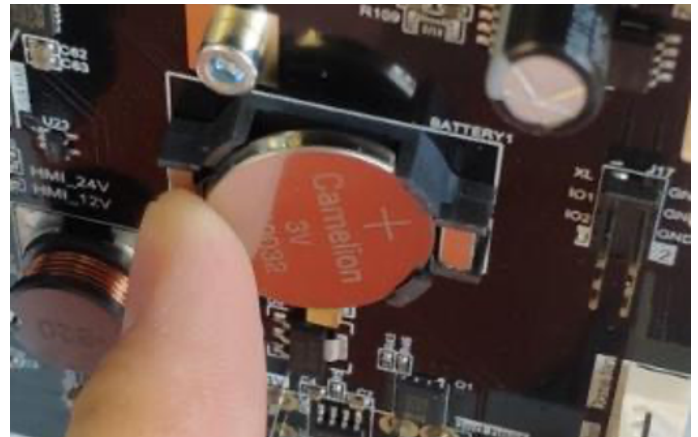

## 7.11. Applying a new Kapton sheet to your build plate

Build plate Kapton sheets get worn out in time or can be damaged by the nozzle due to incorrect leveling or removing the printed models. Reapplying a new Kapton sheet is essential to maximize print qualities if the old one has issues or damage. To reapply a new Kapton sheet, take the build plate out of the unit and remove the old sheet by stripping it off of the flexible metal plate. Clean the surface of the plate with acetone.

Remove the protective plastic backing sheet (keep this safe for later use) from the new Kapton sheet in order to get to the sticky side. Apply some window cleaning liquid onto the plate and to the sticky side of the sheet to help you position the sheet on the build plate correctly. Align the Kapton to the front side of the laser marked grid. Once the positioning is correct, squeeze out the excess liquid from between the plate and the sheet with a thin but solid object, like a used credit card. Before you do so, place the protective sheet (which was removed in the beginning) on top the new Kapton to prevent scratches and damage during this process.

Start from the center of the plate and move horizontally and vertically. Once all the liquid has been squeezed out and the sheet is applied properly, put the plate somewhere to dry. Allow the sticky part to rest for a day before using.

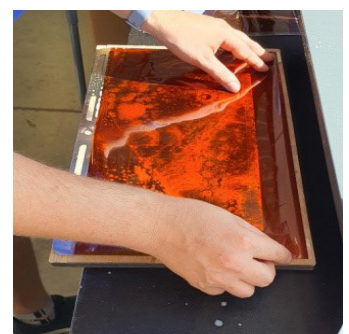
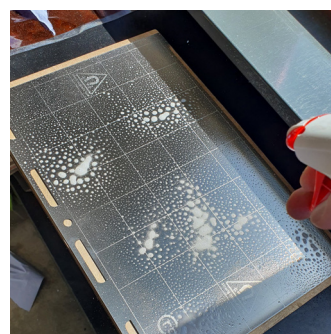
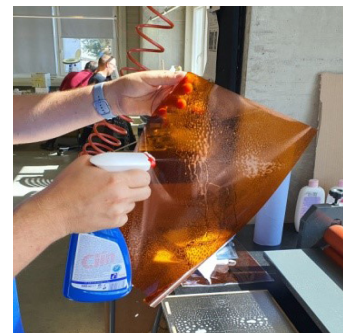



## 7.12. The cleaning kit

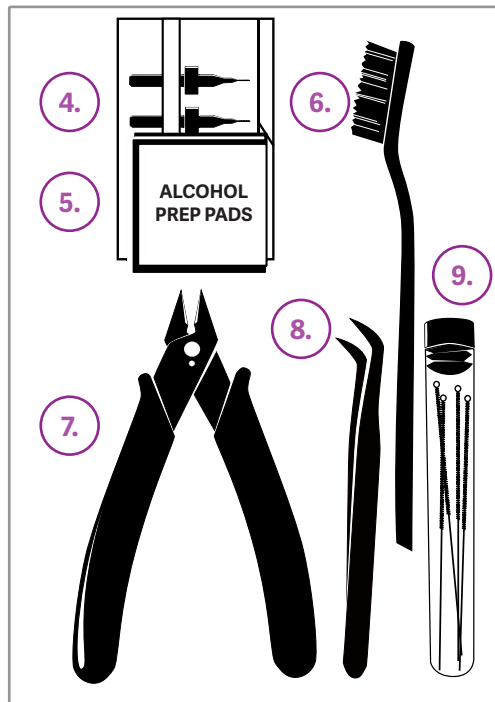
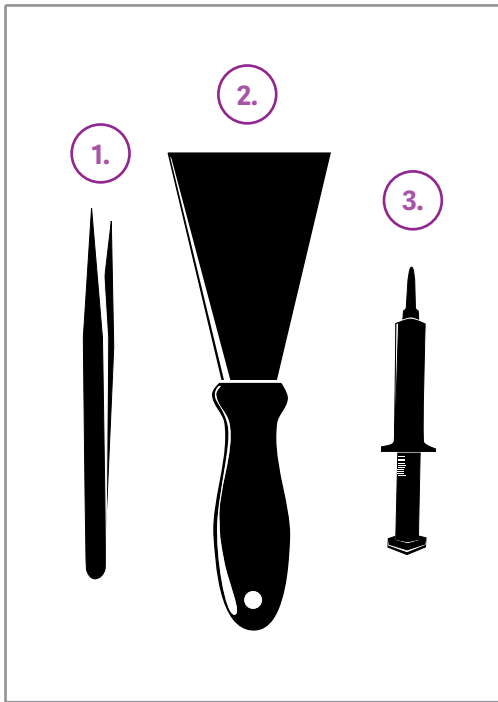

1. Sharp tweezer
2. Spatula
3. Lubricant syringe
4. Nozzle drill bits
5. Alcohol prep pads
6. Wire brush
7. Wire cutter
8. Curved tweezer
9. Nozzle needles

### Sharp tweezer and Curved tweezer

The 2 different shape precision tweezers are perfect for

- nozzle maintenance and
- cleaning material from the feeder gear teeth and other hard to reach areas.

**Caution!** The nozzle cleaning tweezers are sharp; please keep them safe and out of the reach of children.

### Spatula

- You can easily use it to remove the 3D printed object from the bed
- Use it to lift up difficult models, you can even use it to clean your 3D printer build surface.

### Lubricant syringe

PTFE-based lubricant gel

You can use it on the Z Axis screw, guide rail, bearings and any other parts of the transmission assembly.

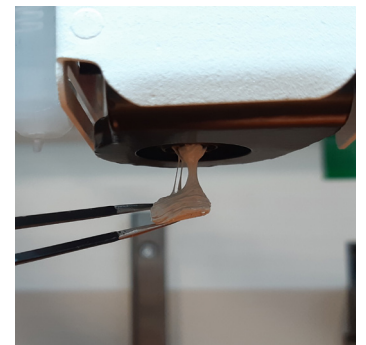
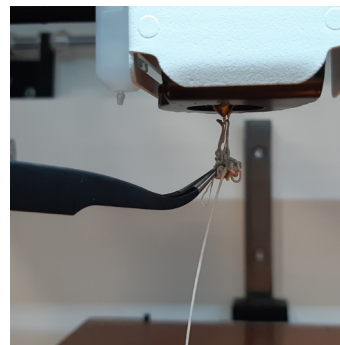

### Nozzle hand drill bits

To help drill the clogged nozzle during the cleaning process.

There are 3 sizes:

- Ø 0,6 mm
- Ø 0,8 mm
- Ø 1 mm

**Caution!** Don't use the drill to clean until the extruder is heated to above 200 degrees.

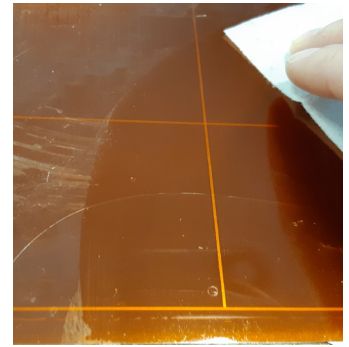
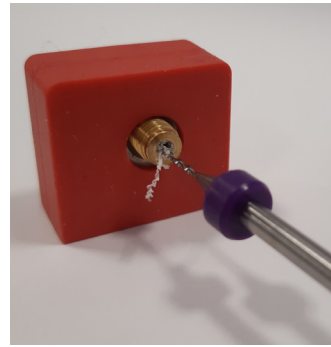

### Alcohol prep pads

Keep the Kapton foil cleaned with alcohol prep pads.

**Caution!** Avoid contact with the eyes and please keep out of reach of children.

After using this product for wiping, it will be completely evaporated leaving and no residue after about 30 seconds.

### Wire brush

Use the wire brush to clean the nozzle and the feed gears.

Don't forget to heat up the nozzle before cleaning.

**Caution!** The brush head is made from copper wire, and it is relatively soft. Therefore, the brush head may be deformed or warped in transportation.



### Wire cut

For trimming the model or cutting off the various 3D printer filaments. Always cut a clean end before placing the filament into the extruder gear.

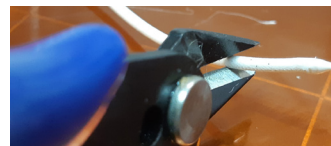

### Nozzle needles

To help remove any excess plastic when clearing jams from the nozzle and any other hard to reach places like the feed gears.

There are 4 sizes:

- 0,25 mm
- 0,4 mm
- 0,6 mm
- 0,8 mm

**Caution!** The nozzle cleaning needles are sharp; please keep them safe and out of the reach of children.

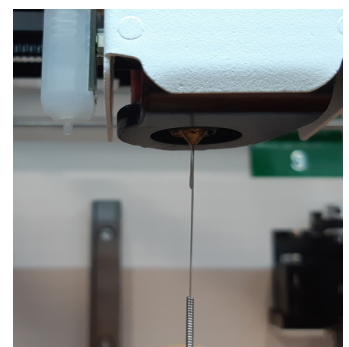
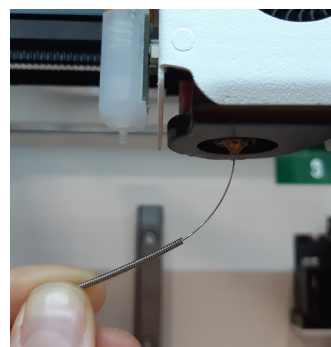

## 8. CRAFTWARE

To print a 3D object, The Craftbot needs toolpath information generated from 3D object CAD files like .obj or .stl.

Toolpath information is simply called “gcode”. CraftWare software converts 3D design files into printing commands for the Craftbot 3D printer. CraftWare was been developed by CraftUnique with the aim of easing and perfecting the printing process.

For detailed user instructions of CraftWare, download the user manual from:  
<https://craftbot.com/docs/craftware-user-manual>





### 8.1. Installing CraftWare

Open a new browser session on the computer you’d like to install CraftWare on.

- Go to [www.craftbot.com/craftware](http://www.craftbot.com/craftware).
- Select the Windows or MAC/OSX or Linux version according to your operation system.
- To select the latest version of CraftWare click the CraftWare Button below.
- Download the installer.
- Open the installer and follow the directions to install the software.

### 8.2. Using CraftWare to generate .gcode files

Once CraftWare has been opened up, you will see a virtual build platform which represents your Craftbot’s real build plate.

- The Options  menu is located on the right side of the screen. In the pop-up window you can set the language, graphics, keyboard commands, colors and Craftbot type. All build areas of all the Craftbots are-pre-set and pre-programmed in.
- Select your printer under the Printer tab. You can add .obj, .stl files onto this virtual build plate and get an idea of what the real life print will look like.
- Select your desired Dual Head mode by clicking on Dual Mode  button you can change the Dual Head mode. There are four of them:
  - Dual Extruder Mode: You can assign an extruder for each object in the project.
  - Support Mode: Lets you select one of the extruders to create the support bars.
  - Parallel Mode: Duplicates the objects, and prints them simultaneously.
  - Mirror Mode: Duplicates and mirrors the objects, then prints them simultaneously.
- Click on the Add  button located in the top row of icons. Select the 3D design plan you want to print. The selected object will appear at the center of the virtual build plate. If Dual Extruder Mode is enabled, you can assign head in the List View under the Selection tool.
- To generate the toolpath information (gcode) click on the Slice  button on the right side of the screen. A new screen pops up with options to specify the printing quality and the material to be used.
- Saving the gcode by clicking the “Slice” button bottom right.
- You can save  the generated gcode onto a USB drive and plug it into the top of the printer or send the information directly to the Craftbot printer if it is connected via a USB cable.

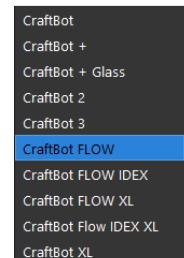

## 9. GUARANTEE AND LIMITATION OF LIABILITY

For special conditions relating to product guarantee, see the „Guarantee Statement” on a separate sheet, which is also delivered with the product.

With the exceptions included in the regulations concerning the guarantee and to the greatest extent permitted by the relating act, Craftunique Ltd. is not responsible for any direct, indirect, specific, stochastic or consecutive damage claims which arise from the breaching of the terms of guarantee or of any other legal concept, including, but not limited to:

- The loss of usability
- The loss of income, the loss of actual or expected profits (including the profit from a contract), the loss of expected savings, the loss of business or business opportunity,
- The loss of or damage to goodwill,
- The loss, breach or destruction of data,
- Any indirect or consecutive damage or loss, including the damage caused by the changing of equipment/ installation or property, and
- The cost of the restoration or reproduction of data stored or used on the Product.

The restriction above does not affect the liability of Craftunique Ltd. for intentional or serious negligence and/or default. Certain jurisdictions do not allow the exclusion or limitation of accidental or consecutive damage, therefore if such jurisdiction regulates the guarantee, the restrictions above do not apply to you.

Concerning any problems or inquiries you can contact us at [support@craftunique.com](mailto:support@craftunique.com)

Cooperation between 3D printer and people has never been easier.

# Get in touch!

## CONTACT:

CraftUnique Ltd.

Salgótarjáni str. 12-14.

Budapest 1087, Hungary

Phone: +36 1 700 8060

Web: [www.craftbot.com](http://www.craftbot.com) • [www.craftbotusa.com](http://www.craftbotusa.com)

Craftbot is made in the EU.

Copyright 2013-2020 by CraftUnique Ltd. All Rights Reserved.



**craftbot**