

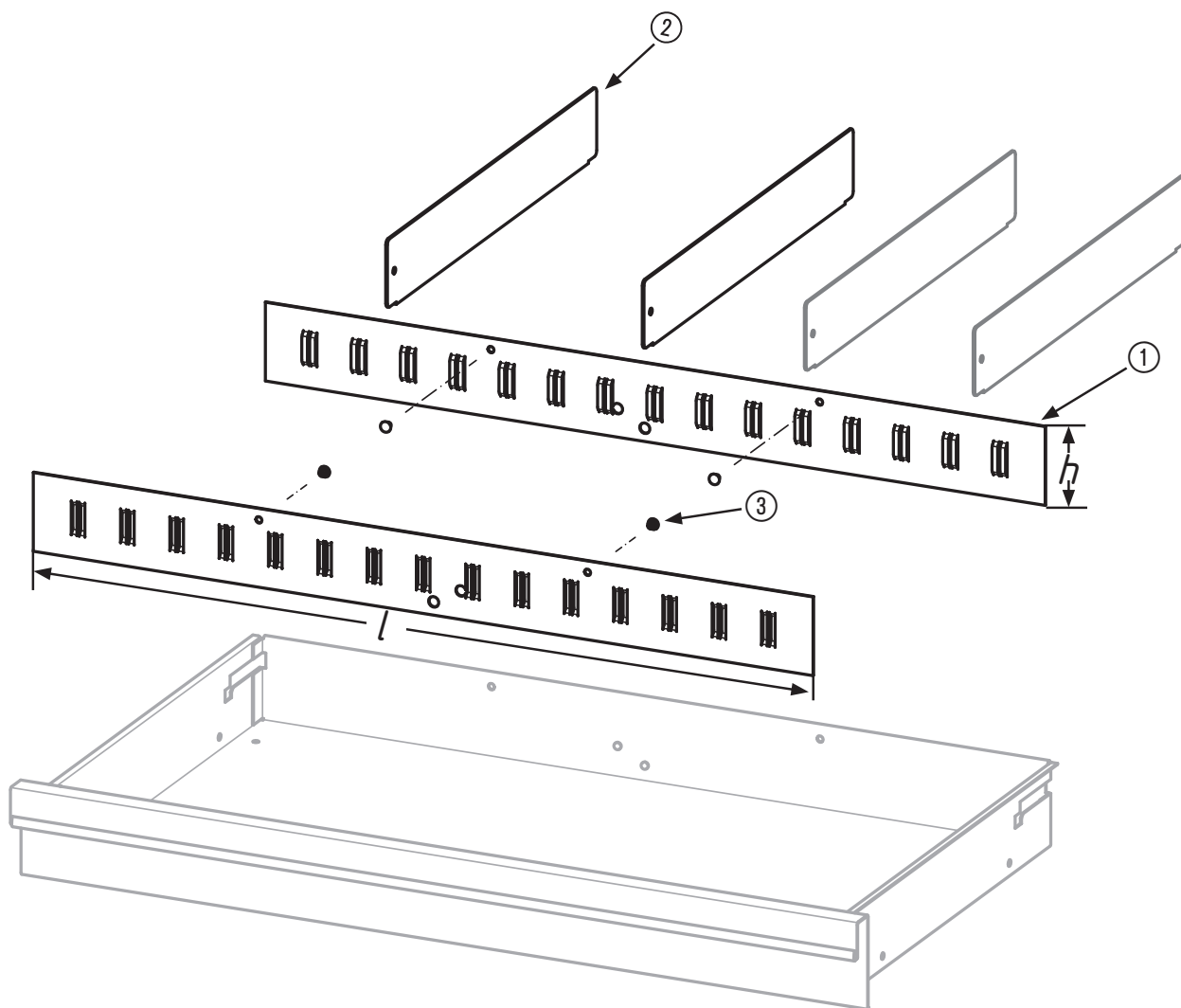











161 T-179 N Trennbleche

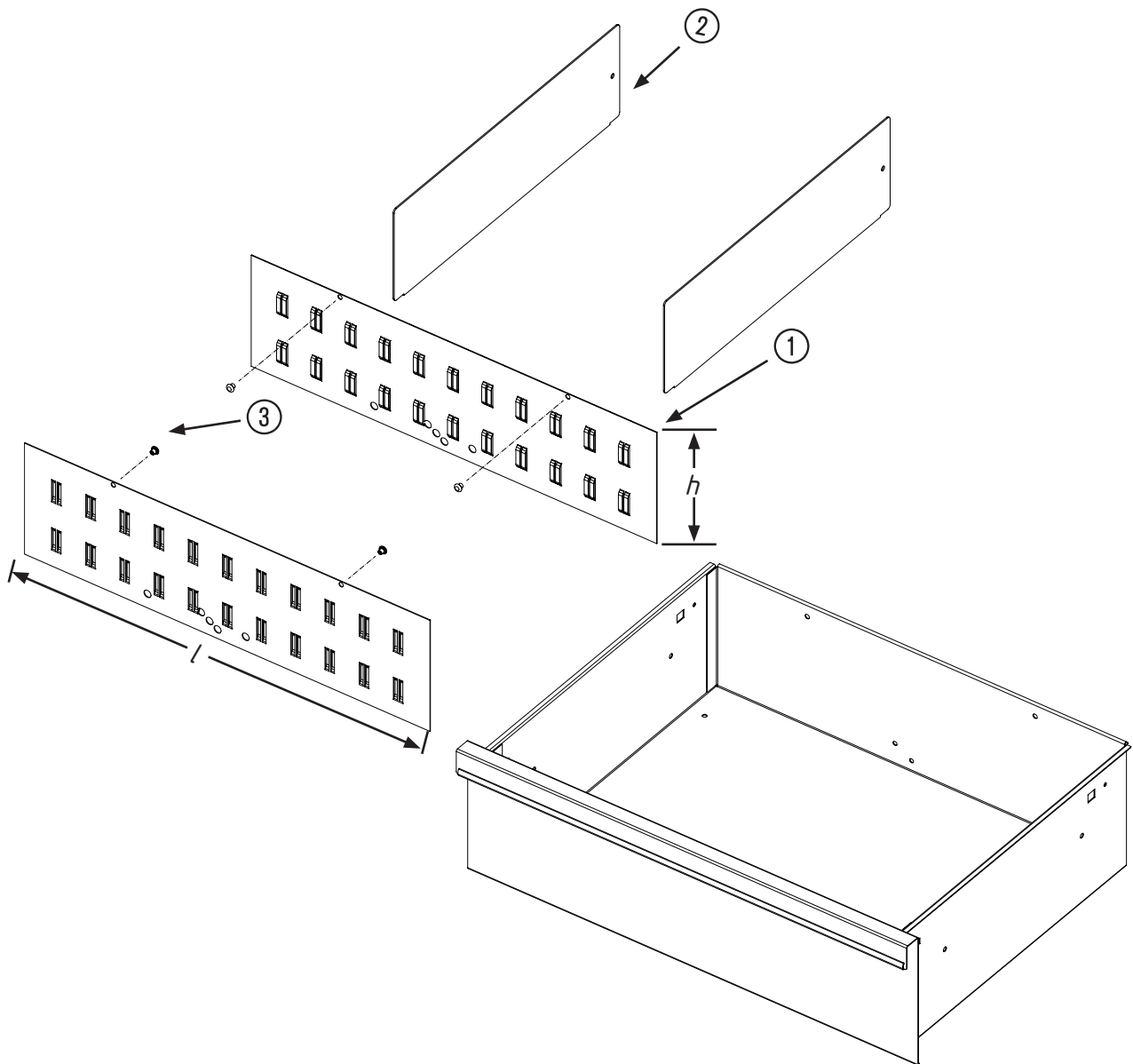





HAZET No.			$\longleftrightarrow l \longleftrightarrow$	$\longleftrightarrow h \longleftrightarrow$	
161 T-179 N/4	4	①	516 mm	58,0 mm	2
		②			2
		③			4
161 T-179 N XL/5	5	①	688 mm	58,0 mm	2
		②			3
		③			4
161 T-179 N XXL/6	6	①	863 mm	58,0 mm	2
		②			4
		③			8
161 T-395x60/5	5	②			5



HAZET No.			$\longleftrightarrow l \longleftrightarrow$	$\longleftrightarrow h \longleftrightarrow$	
161 T-179 N/4H	4	①	516 mm	143,0 mm	2
		②			2
		③			4
161 T-179 N XL/5H	5	①	688 mm	143,0 mm	2
		②			3
		③			4
161 T-179 N XXL/6H	6	①	863 mm	143,0 mm	2
		②			4
		③			8
161 T-395x120/5	5	②			5

HAZET - WERK Hermann Zerver GmbH & Co. KG

 Gldenwerther Bahnhofstrae 25 - 29 • 42857 REMSCHEID • GERMANY

 +49 (0) 21 91 / 7 92-0 •  +49 (0) 21 91 / 7 92-375 (Deutschland) •  www.hazet.de •  info@hazet.de