

SOGO®

Human Technology

manual de instrucciones / instructions for use
mode d'emploi / manual de instruções
gebrauchsanweisung / manuale d'istruzioni /
Návod k použití



COCINA MULTIFUNCIÓN
MULTIFUNCTION COOKER
CUISINIÈRE MULTIFONCTION
FOGÃO MULTIFUNÇÕES
MULTIFUNKTIONSKÖCHER
FORNELLO MULTIFUNZIONE
MULTIFUNKČNÍ VARIČ

Precaución: lea y conserve estas importantes instrucciones
Caution: please read and preserve these important instructions

ref. SS-14565



Este manual de instrucciones también se puede descargar desde nuestra página web
www.sogo.es

Lea estas instrucciones detenidamente antes de usar el producto

1. Lea estas instrucciones cuidadosamente y guárdelas para futuras referencias.
2. Apague el aparato y desconéctelo del suministro antes de cambiar los accesorios o acercarse a las piezas que se mueven cuando está en uso.
3. Mantenga las partes del cuerpo, las joyas y la ropa suelta alejadas de las partes móviles y las herramientas / aditamentos ajustados.
4. Siempre quite la cuchilla antes de verter el contenido del tazón.
5. Mantenga las manos y los utensilios fuera del recipiente mientras está conectado a la fuente de alimentación.
6. Nunca use un aparato dañado. Hágalo revisar o reparar.
7. No exceda el nivel de llenado máximo marcado en el interior del tazón.
8. Nunca permita que la unidad de alimentación, el cable o el enchufe se mojen.
9. Tenga cuidado al manipular o tocar cualquier parte del aparato cuando se esté utilizando en el modo de cocción o después de cocinar. En particular, el recipiente, la tapa y las herramientas, ya que permanecerán **CALIENTES** mucho después de que se haya apagado el aparato.
10. Use las manijas para quitar y transportar el tazón. Use guantes para horno cuando

manipule el tazón caliente y las herramientas calientes.

11. La parte inferior del recipiente permanecerá caliente mucho tiempo después de que se haya detenido el calentamiento. Tenga cuidado al manipular y use una alfombrilla de protección de la superficie de trabajo al colocar el recipiente sobre superficies sensibles al calor.
12. Tenga cuidado de que salga vapor del tazón, particularmente al quitar la tapa o el tapón de llenado.
13. No quite la tapa ni el tapón de llenado mientras el líquido esté hirviendo.
14. Siempre cierre la tapa de llenado cuando use la función de corte.
15. Utilice únicamente el tazón y las herramientas suministradas con este aparato. Nunca use el tazón con ninguna otra fuente de calor.
16. Nunca opere el aparato en el modo de cocción con el recipiente vacío.
17. No use la tapa de la licuadora para operar el procesador. El aparato se dañará y puede causar lesiones si el mecanismo de enclavamiento se somete a una fuerza excesiva.
18. Al usar este aparato, asegúrese de que esté colocado en una superficie nivelada, lejos del borde. No lo coloque debajo de armarios colgantes.
19. Para un funcionamiento correcto y seguro, asegúrese de que la base del recipiente y los sensores de temperatura estén limpios y secos antes de cocinar.
20. **PRECAUCIÓN: para evitar un peligro debido al reinicio accidental del corte térmico, este**

aparato no debe ser alimentado a través de un dispositivo de conmutación externo, como un temporizador, o conectado a un circuito que se enciende y apaga regularmente.

21. Asegúrese siempre de que los alimentos estén bien cocidos y calientes antes de comerlos.
22. Los alimentos se deben comer poco después de cocinarlos o dejarlos enfriar rápidamente y luego refrigerarlos lo antes posible.
23. El mal uso de su aparato puede provocar lesiones.
24. Los aparatos pueden ser utilizados por personas con capacidades físicas, sensoriales o mentales reducidas o con falta de experiencia y conocimiento si se les ha dado supervisión o instrucciones sobre el uso del aparato de manera segura y si comprenden los riesgos involucrados.
25. Los niños no deben jugar con el aparato.
26. Este aparato no debe ser utilizado por niños. Mantenga el aparato y su cable fuera del alcance de los niños. Nunca deje que el cable cuelgue donde un niño pueda agarrarlo.
- 27. Advertencia: Tenga cuidado al manipular las afiladas cuchillas de corte, vaciar el recipiente y durante la limpieza.**
28. Siempre desconecte el aparato del suministro si se deja desatendido y antes del montaje, desmontaje o limpieza.
29. Si el cable de alimentación está dañado, debe reemplazarse con un conjunto de cable especial disponible por parte del fabricante o de su agente de servicio, para evitar riesgos.
30. Utilice el aparato solo para su uso doméstico

previsto. No aceptaremos ninguna responsabilidad si el electrodoméstico está sujeto a un uso inadecuado o si no cumple con estas instrucciones.

31. La carga máxima para la función de mezcla es de 920 g de zanahorias / 1380 g de agua
32. Tenga cuidado si se vierte líquido caliente en el procesador de alimentos o la licuadora, ya que puede expulsarse del aparato debido a un vapor repentino.
33. El aparato solo debe usarse con el soporte provisto.
34. El aparato es solo para uso doméstico y de interior.
35. Evite derrames en el conector.
36. No desmonte la base de la copa (incluida la carcasa del asa), no es para mantenimiento del usuario.
37. Después de que el motor deja de funcionar, el ventilador de enfriamiento seguirá funcionando durante otros 2 minutos.
38. **Las superficies pueden calentarse durante el uso.** 
39. Para saber cómo limpiar las superficies en contacto con los alimentos, consulte el párrafo Cuidado y limpieza.
40. **PRECAUCIÓN: asegúrese de que el aparato esté apagado antes de retirarlo del soporte. Antes de enchufar Asegúrese de que su suministro de electricidad sea el mismo que se muestra en la parte inferior de su electrodoméstico. ADVERTENCIA: ESTE APARATO DEBE SER CONECTADO A TIERRA.**

1. Descripción del producto

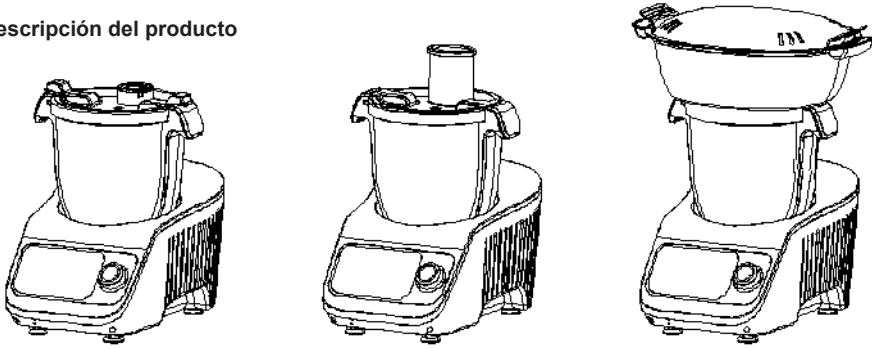

2. Partes

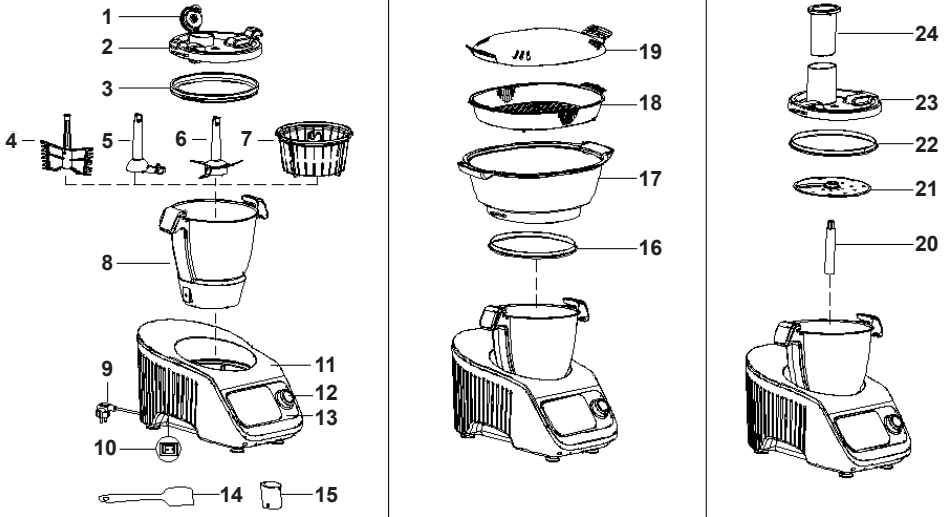

3. Pantalla de visualización

1) Interfaz de usuario DIY

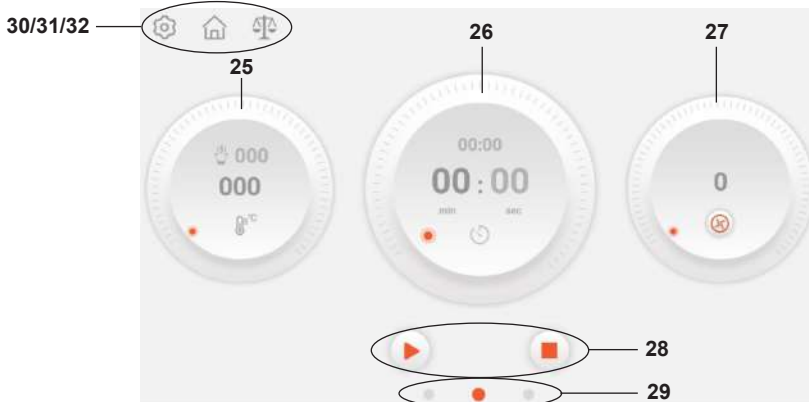

2) Programas automáticos IU



3) Receta IU

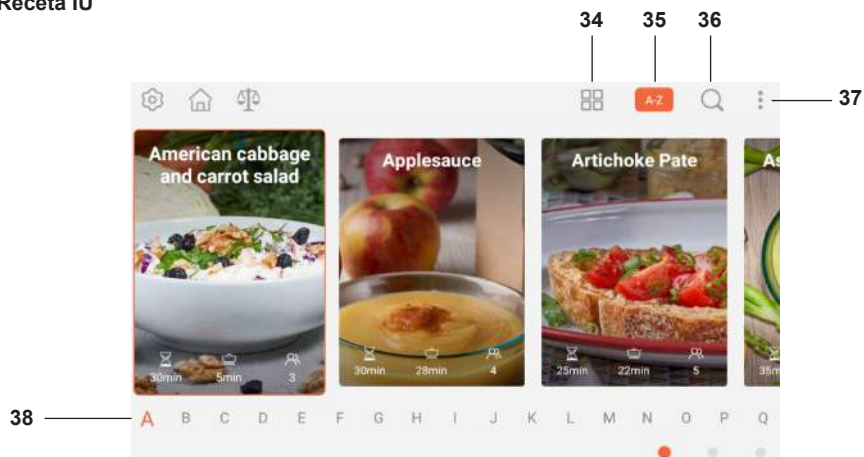

4) Configuración de la UI

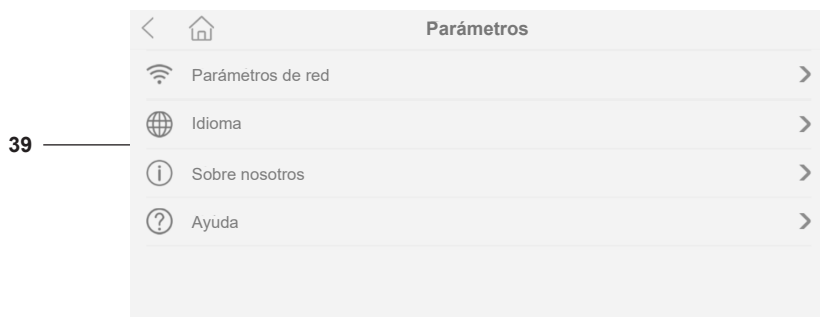

5) Inicio UI



4. Partes clave

No.	Nombre	No.	Nombre	No.	Nombre
1	Tapón de relleno	16	Sello de la cesta de vapor profunda	31	Botón de inicio
2	Tapa de la licuadora	17	Cesta de vapor profunda	32	Botón de peso
3	Sello de la tapa de la licuadora	18	Cesta de vapor, poco profunda	33	Botón de función
4	Batidor	19	Tapa para cesta de vapor	34	Gestión de orden
5	Paleta agitadora	20	Eje de accionamiento	35	A-Z
6	Cuchilla	21/21A	Cortadora / trituradora	36	Botón de búsqueda
7	Cesta de vapor	22	Sello para tapa FP	37	Botón Más
8	Jarra licuadora	23	Tapa FP	38	Botón A-Z
9	Cable de alimentación	24	Empujador	39	Configuración IU
10	Interruptor principal	25	Botón de temperatura	40	Recetas IU
11	Unidad base	26	Botón temporizador	41	DIY IU
12	Perilla	27	Botón de velocidad	42	Programa automático IU
13	Pantalla de visualización	28	Botón de inicio / pausa / parada	43	Descarga UI
14	Espátula	29	Punto de cambio de interfaz		
15	Taza de medición	30	Botón de configuración		

5. Para configurar antes de usar

1

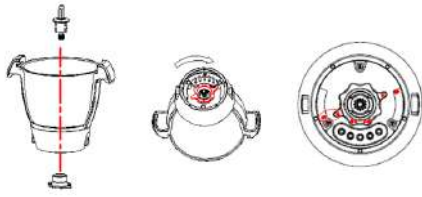

Coloque el eje de transmisión correctamente bloqueado en la jarra.

2

Inserte la jarra en la unidad principal. Presione hacia abajo firmemente para bloquearla en su lugar.



3

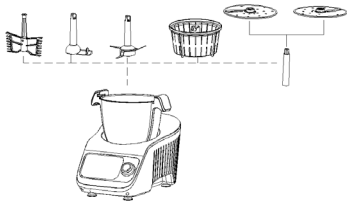

Elija diferentes accesorios para diferentes propósitos de cocción.

4

Agregue ingredientes o agua a la jarra. Si necesita la función de procesador de alimentos, coloque la tapa del procesador de alimentos y coloque los ingredientes

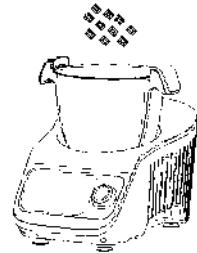

5



Coloque la tapa de la mezcla, la tapa FP o el vaporizador.

6

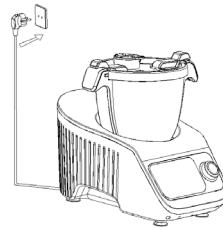

Conecte el cable de alimentación a la base principal, luego enciéndalo. Cuando la base principal tiene el cable de alimentación, no monte el cable de alimentación.

7



Deslice el icono correspondiente o gire la perilla para configurar la temperatura, el tiempo y la velocidad. Haga clic en el minuto o segundo en el icono de hora para configurar rápidamente la hora exacta. Función inversa: haga clic en el icono ▶ para cambiar la dirección de rotación

8



Haga clic en ▶ después de configurar la temperatura, el tiempo y la velocidad para comenzar, luego el icono cambiará a || la máquina ahora está funcionando.

Haga clic o presione el botón || en la perilla para pausar el trabajo, haga clic en ■ o presione continuamente el botón en la perilla para dejar de funcionar y salir del programa.

9



Al deslizar hacia la derecha en la pantalla o hacer clic en el punto derecho en el círculo rojo o girar la perilla en el sentido de las agujas del reloj, accederá al menú de funciones comunes. Haga clic en o haga clic en el punto del medio en el círculo rojo para volver al paso inicial para restablecer.

10



Haga clic en el icono de función en el menú de funciones comunes para ir a la interfaz de pantalla correspondiente. Comience a trabajar después de completar los pasos 7 y 8. Haga clic para salir de esta interfaz. Este icono es para vaporizar.

11

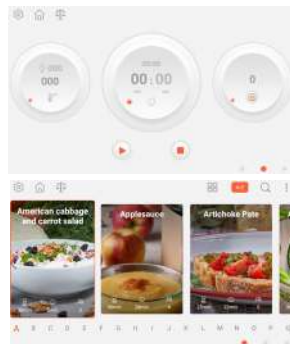

Deslizando hacia la izquierda en la pantalla o haciendo clic en el punto izquierdo en el círculo rojo o girando la perilla en sentido antihorario, accederá al menú de recetas. Haga clic en o haga clic en el punto del medio en el círculo rojo para volver al paso inicial para restablecer.

12



Haga clic en la foto de la receta, ingrese a la interfaz de la receta, haga clic en

para verificar todos los detalles de la receta. Haga clic en para comenzar y para la colección favorita.

13



La receta tiene parámetros preestablecidos. Haga clic en para comenzar. El número en el círculo rojo representa cada paso de trabajo, haga clic en para verificar todos los detalles de la receta.

14

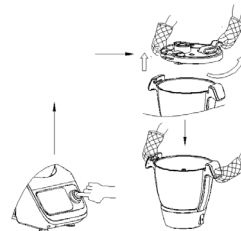

Después de cocinar, la pantalla mostrará Fin. Presione el botón giratorio y dejará de cocinarse. Si desea suspender durante la cocción, presione el botón giratorio. Luego presione nuevamente y la olla continuará cocinando. La cocina dejará de cocinar si mantiene presionada la perilla giratoria.

15

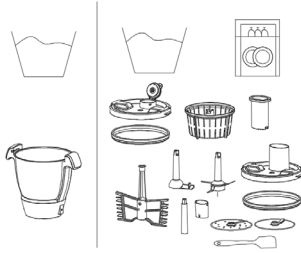

Accesorios que se pueden poner en el lavavajillas.



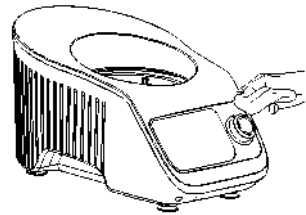















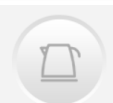



16





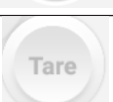





Limpiar la unidad principal

6. Descripción general del panel de control

Número de serie	Icono	Función descriptiva
12		(1) Se puede usar para ajustar la temperatura, el tiempo y la velocidad; o IU, programa automático, receta. (2) Presione la perilla y la olla suspenderá la cocción. Continuará cocinando si presiona nuevamente. O confirma su elección. (3) Mantenga presionada la perilla y dejará de cocinar. (4) Presione la perilla después de terminar todos los ajustes y la cocción comenzará. (5) Se cancelará automáticamente si mantiene presionada la perilla durante la configuración. (6) Cuando termine de cocinar, presione la perilla y la cocina entrará en modo de espera.
27.1		Reverso Rango de velocidad: 1-3
27.2		Velocidad: haga clic en para cambiar entre sentido horario e inverso Rango de velocidad: 0-12
26		Parámetro de tiempo establecido de visualización: 0-90 minutos Visualización del tiempo de operación: 0-90 minutos
25.1		Mostrar el parámetro de temperatura establecido Rango de temperatura: 37-120 °C Después de 37, 40 °C, en intervalos de 5°
25.2		Ícono Cerrar / Abrir
25.3		Temperatura de alimentos / ingredientes: después de 37, 40 °C, en intervalos de 5°
28		: botón inicio, : pausa, : detener
30		Botón de configuración: configure o verifique la información de cocción del robot, incluyendo: Wifi, versión del sistema, idioma, etc.

31		Botón de inicio: página de inicio	
32		Botón de peso	
33.1		Amasar: Tiempo: 3 (Rango: 2-4) minutos Temp: 000 (Rango: 000-37) °C Velocidad: 2 (Rango: 1-3)	
33.2		Vapor: Tiempo: 20 (Rango: 1-60) minutos Flujo de vapor: rápido / medio / lento La cuenta atrás del tiempo comienza desde 95 °C	
33.3		Cocción lenta Tiempo: 60 (Rango: 10-90) minutos Temp: 100 (Rango: 60-100) °C Velocidad: 1 (Rango: 1-3)	
33.4		Hervir Temp: 100 (Rango: 60-100) °C	
33.5		Procesador de alimentos Tiempo: 30 (Rango: 10-60) segundos Velocidad: 5 (Rango: 5-7)	
33.6		Picar Tiempo: 10s (Rango: 10s-4m) Velocidad: 6 (Rango: 1-12)	
33.7		Turbo Tiempo: 60s Velocidad: 12 Presione  o presione la perilla y suelte para detener	
33.8		Pesar Máx .: 5Kgs Intervalo de 5 g	
33.8.1		Tara	
33.8.2		Fin de pesaje	
34		Gestión de clasificación	
35		A-Z	
36		Buscar	

37		Más Incluyendo colección e historia favoritas
44		Salir
45	 	Favorito / Historia
46		Ingredientes
47		Etapa de cocción
48		Consejos del chef
49		Accesorios Picto
50		Verifique la información de la receta incluyendo

7. Ajustar la hora

7.1: Rango de tiempo: 0-90 minutos

7.2: Haga clic en  , haga clic en min o seg, deslice o gire la perilla para configurar el tiempo

8. Ajuste de la temperatura

8.1: Rango de temperatura: 37-120°C, con intervalo de 5°C

8.2: Haga clic en  deslice el picto o gire la perilla para establecer la temperatura

9. Ajuste de la velocidad

9.1: Rango de velocidad: 0-12

9.2: haga clic en  , deslice el picto o gire la perilla para establecer la velocidad

9.3  : haga clic en  , cambie a  con la configuración de velocidad 1-3

9.4:  velocidad 1-3:

 velocidad 1-4:

 velocidad 1-12

10. Comenzar, pausar y parar

10.1  Comenzar

10.2  Pausar

10.3  Parar

Durante el modo de espera, las luces blancas y rojas parpadean. La luz roja debajo de la perilla se enciende cuando la temperatura es superior a 60°C, y la luz blanca se enciende cuando la temperatura es inferior a 60°C, en cualquier modo

11. Uso sugerido

Método				
Función	Accesorio	Velocidad	Tiempo	Máximo de ingredientes para cocinar en una sola vez
Picar carne	Cuchilla de cortar	Velocidad 8-12	30s-60s	600 g de ternera / cerdo sin hueso / tendón
Hielo picado	Cuchilla de cortar	Velocidad 8-12	10-20s	600 g de cubitos de hielo
Licuada	Cuchilla de cortar	Velocidad 12	1min	Capacidad máxima: 2300 ml 920 g de zanahoria 1380 g de agua
Cortar (Cebolla, chalota, apio, etc.)	Cuchilla de cortar	Velocidad 5	15s-30s	500g
Amasar	Cuchilla de cortar	Velocidad 1	2mins	500 g de harina + 250 g de agua + 20 g de aceite
Rebanadas, trozos (Zanahoria, pepino, patata)	discos de corte	Velocidad 5-6	30s	500g
Sopa	Paleta para remover	Velocidad 1	Elija la función de sopa. O puede configurar el tiempo, la velocidad y la temperatura adecuados por su cuenta.	Capacidad Máxima 2000ml

12. Cuidado y limpieza:

12.1. Apague y desenchufe siempre antes de limpiar.

12.2. Retire la tapa y la herramienta del recipiente antes de limpiar,

12.3. Unidad de potencia. Limpie con un paño húmedo, luego seque. Nunca use abrasivos ni la sumerja en agua.

12.4. Cuando haya una marca de quemado en el fondo de la jarra de la licuadora, ponga un poco de ácido cítrico o limones en agua, caliente durante 5 ~ 7 minutos, luego quite la marca de quemado con un trapo



12.5. Tazón / paleta agitadora / cuchilla. Lave las partes, luego seque bien. Si la comida o los quemados se adhieren al interior del tazón, retírelos con una espátula tanto como sea posible. Llene el recipiente con agua jabonosa tibia y déjelo en remojo. Elimine los depósitos rebeldes con un cepillo de limpieza. Cualquier decoloración del tazón no afectará su rendimiento.

12.6. Cómo sacar la cesta de vapor

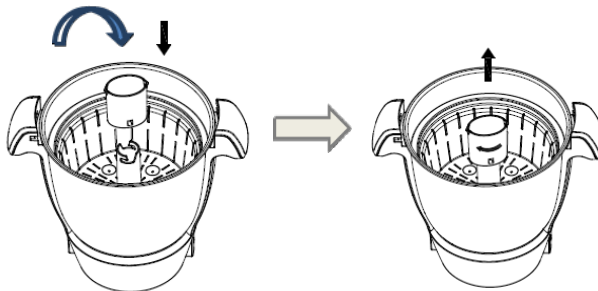
Coloque la taza medidora en la ranura de la cesta de vapor y gire para fijar. Entonces, sacar.

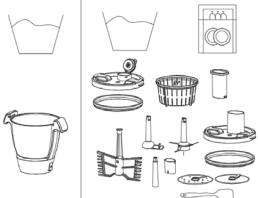

13. Limpieza y mantenimiento

Desenchufe el cable de alimentación antes de limpiar	Use un trapo seco para limpiar la unidad principal. No lavar con agua ni poner en el lavavajillas.
<p>Tapa, vaso medidor, cuchilla, paleta para mezclar, cesta de vapor, vaporizador, etc. Todos los accesorios en la imagen de arriba se pueden lavar con lavavajillas</p> 	<p>El cepillo de metal, el cepillo de nylon, el limpiador doméstico, el diluyente, los productos de limpieza, etc. dañarán la superficie de la estructura del producto.</p> 
Utilice un paño seco y suave para limpiar el cable de alimentación.	

14. Especificación de producto

Modelo: SS-14565

Tensión nominal: 220-240V~ 50-60Hz

Potencia de calentamiento: 1000W

Potencia de mezcla: 600W

Capacidad del tazón: 2.0L/3.5L(Max)

Potencia de calentamiento + Potencia de mezcla: 1300W

15. Restablecer control de temperatura



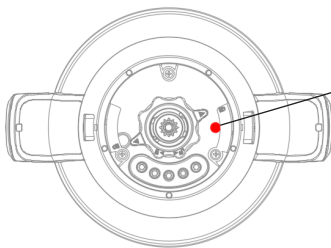



Si la máquina deja de funcionar debido a una temperatura excesiva, puede presionar el botón de restablecimiento de temperatura ubicado en la parte inferior de la jarra. Asegúrese de que la jarra se enfríe y luego haga que funcione nuevamente.

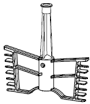

Botón de reinicio de temperatura
Presione y haga clic

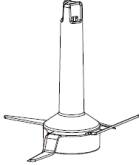
VISTA INFERIOR DE
LA JARRA

16. Descripción general de accesorios

Parte clave		Función	Velocidad	Tiempo	Temperatura°C
	Batidor	Batir clara de huevo	4	2-4 minutos	---
		Crema batida	3	3-5 minutos	---
	Paleta agitadora	Sopa	1-2	1-90 minutos	100°C
		Otros ingredientes que necesitan ser calentados	1-2	Según necesidad	Según necesidad
	Cuchilla	Picar carne	8-12	30-60s	---
		Azúcar triturado de hielo	8-12	10-20s	--
		Licuada	8-12	1-2 minutos	---
		Cortar Cebolla, chalota, apio, etc.	5-7	15-60s	---
		Frijoles, soja, nueces, cacahuete, Grano de café, almendra	12	2-3 minutos	---
		Amasar	1	1-2 minutos	--
	Cesta de vapor	Arroz, etc.	---	20-30 minutos	100-110°C
	Cortadora / trituradora de disco	Rebanadas	5-6	30-60s	--
	Vaporera	Pescado...	---	10-60 minutos	110-120°C

This instruction manual can also be downloaded from our web page **www.sogo.es**

Please read these instructions carefully before using the product

1. Read these instructions carefully and keep for future reference.
2. Switch off the appliance and disconnect from supply before changing accessories or approaching parts that move in use.
3. Keep body parts, jewelry and loose clothing away from moving parts and fitted tools/ attachments.
4. Always remove the blade before pouring contents from the bowl.
5. Keep hands and utensils out of the bowl whilst connected to the power supply.
6. Never use a damaged appliance. Get it checked or repaired.
7. Do not exceed the maximum fill level marked on the inside of the bowl.
8. Never let the power unit, cord or plug get wet.
9. Be careful when handling or touching any part of the appliance when being used in the cook mode or after cooking. In particular the bowl, lid and tools as they will remain HOT long after the appliance has been switched off.
10. Use the handles to remove and carry the bowl. Use oven gloves when handling the hot bowl and hot tools.
11. The underside of the bowl will remain hot long after the heating has stopped. Use caution when handling and use a work surface

protection mat when placing the bowl on heat sensitive surfaces.

12. Be careful of steam escaping from the bowl particularly when removing the lid or filler cap.
13. Do not remove the lid or filler cap whilst liquid is boiling.
14. Always close the filler cap when using the chopping function.
15. Only use the bowl and tools supplied with this appliance. Never use the bowl with any other heat source.
16. Never operate the appliance in the cook mode with the bowl empty.
17. Do not use the blender lid to operate the processor. This appliance will be damaged and may cause injury if the interlock mechanism is subjected to excessive force.
18. When using this appliance ensure it is positioned on a level surface away from the edge. Do not position below overhanging cupboards.
19. For the correct and safe operation ensure that the bowl base and temperature sensors are clean and dry before cooking.
20. **CAUTION: In order to avoid a hazard due to inadvertent resetting of the thermal cut-out, this appliance must not be supplied through an external switching device, such as a timer, or connected to a circuit that is regularly switched on and off by the utility.**
21. Always ensure food is thoroughly cooked and is piping hot before eating.
22. Food should be eaten shortly after cooking or allowed to cool quickly and then refrigerated

as soon as possible.

23. Misuse of your appliance can result in injury.
24. Appliances can be used by persons with reduced physical, sensory or mental capabilities or lack of experience and knowledge if they have been given supervision or instruction concerning use of the appliance in a safe way and if they understand the hazards involved.
25. Children shall not play with the appliance .
26. This appliance shall not be used by children. Keep the appliance and its cord out of reach of children. Never let the cord hang down where a child could grab it.
- 27. Warning: Be careful when handling the sharp cutting blades ,emptying the bowl and during cleaning .**
28. Always disconnect the appliance from the supply if it is left unattended and before assembly, disassembly or cleaning.
29. If the supply cable is damaged, it must be replaced with a special cable assembly available from the manufacturer or its service agent in order to avoid a hazard
30. Only use the appliance for its intended domestic use. We will not accept any liability if the appliance is subject to improper use, or failure to comply with these instructions.
31. The maximum load for blending function was 920 g carrots / 1380 g water
32. Be careful if hot liquid is poured into the food processor or blender as it can be ejected out of the appliance due to a sudden steaming.
33. The appliance is only to be used with the

stand provided.

34. The appliance is for household and indoor use only.

35. Avoid spillage on the connector.

36. Do not disassemble the base of cup (including handle enclosure), it's not for user maintenance.

37. After the motor stop working (if it was) , the cooling fan will still keep working for another 2mins

38. Surfaces are liable to get hot during use.



39. For how to clean the surfaces in contact with food please refer the paragraph of Care and Cleaning.

40. CAUTION :Ensure that the appliance is switched off before removing it from the stand.

Before plugging in

Make sure your electricity supply is the same as the one shown on the underside of your appliance.

WARNING: THIS APPLIANCE MUST BE EARTHED.

1. Product overview

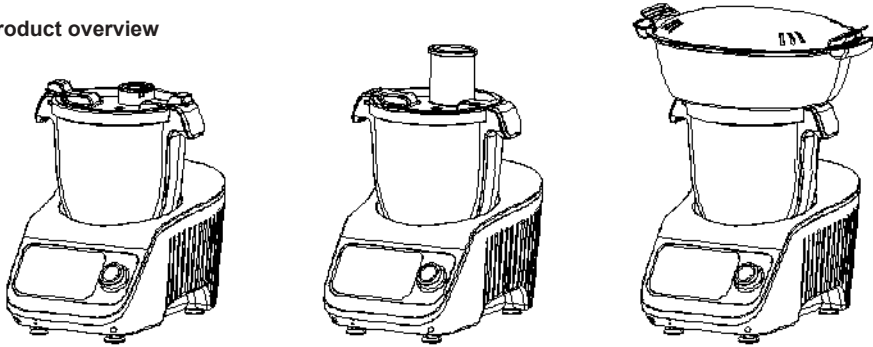

2. Parts

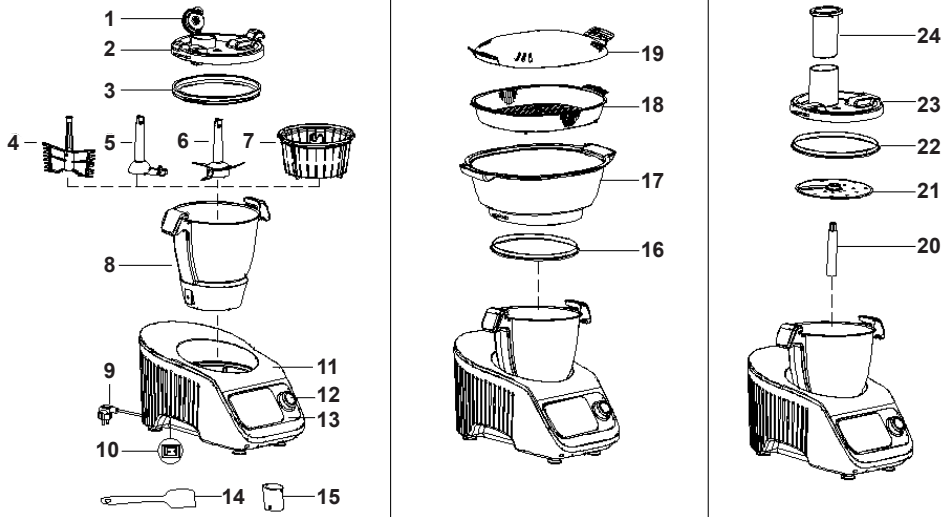

3. Display screen

1) DIY UI

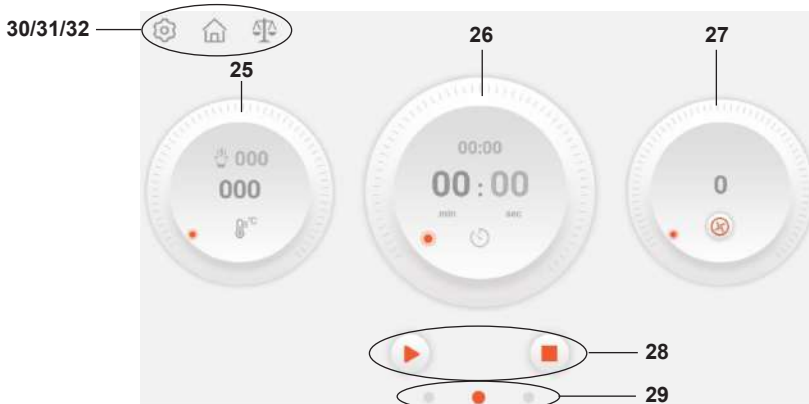

2) Auto programs UI

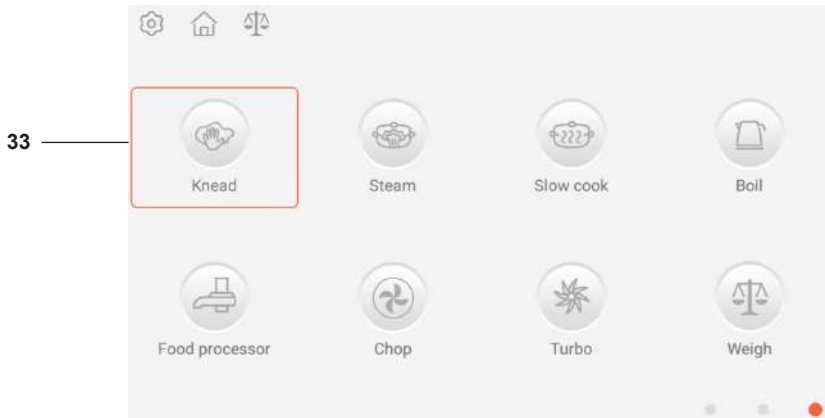

3) Recipe UI

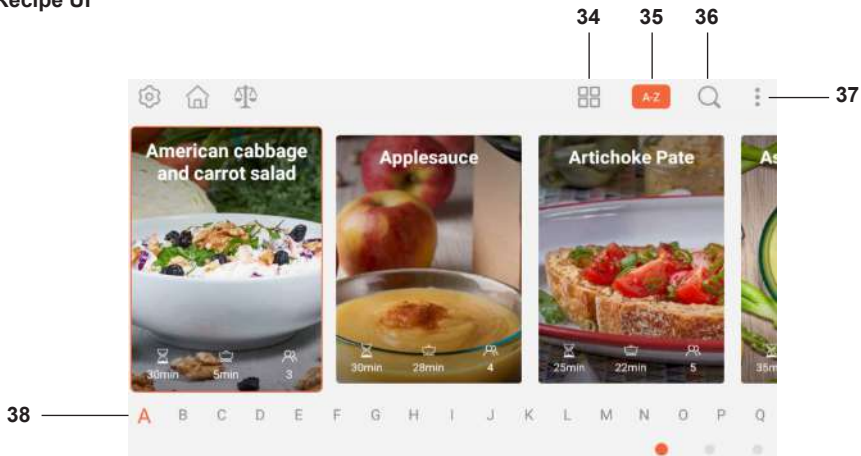

4) Setup UI

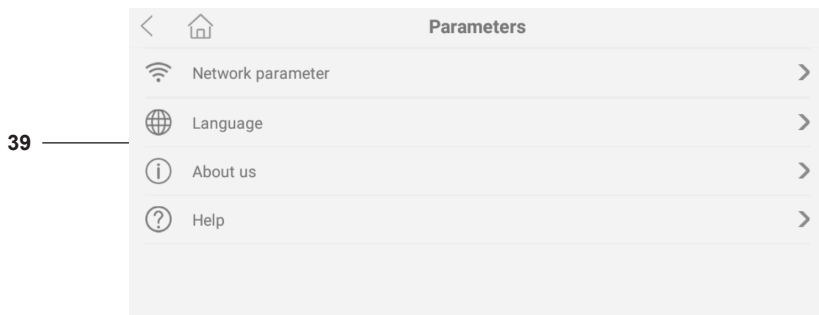

5) Home UI

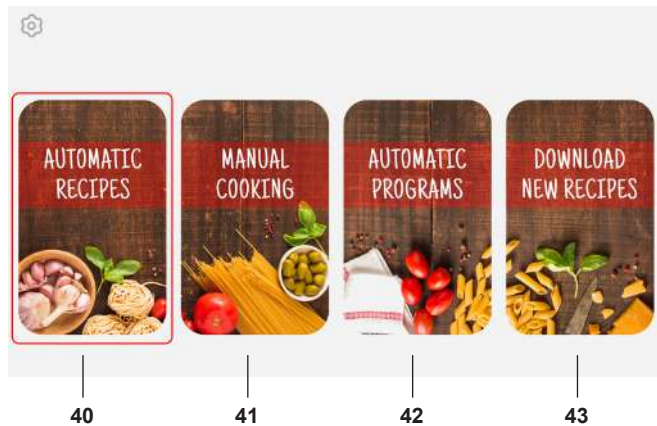

4. Key Parts

No.	Name	No.	Name	No.	Name
1	Filler cap	16	Seal of deep steamer basket	31	Home Button
2	Blender Lid	17	Steamer basket, deep	32	Weight Button
3	Blender lid seal	18	Steamer basket, shallow	33	Function Button
4	Whisk	19	Lid for steamer basket	34	Sort management
5	Stir paddle	20	Driving shaft	35	A-Z
6	Blade	21/21A	Slicer/shred	36	Search Button
7	Steam basket	22	Seal for FP lid	37	More Button
8	Blender jug	23	FP lid	38	A-Z button
9	Power cord	24	Pusher	39	Setup UI
10	Main switch	25	Temperature Button	40	Recipes UI
11	Base unit	26	Timer Button	41	DIY UI
12	Knob	27	Speed Button	42	Auto program UI
13	Display screen	28	Star/Pause/Stop Button	43	Download UI
14	Spatula	29	Interface shift dot		
15	Measuring cup	30	Setup Button		

5. To set-up before use

1

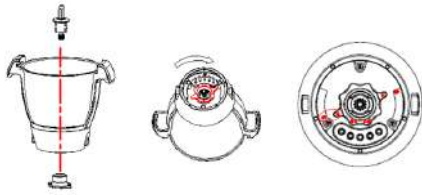

Place the drive shaft correctly locked into the jug

2

Insert the Jug into the Main Unit. Press down firmly to lock into place, (LOGO in front), Max in back)



3

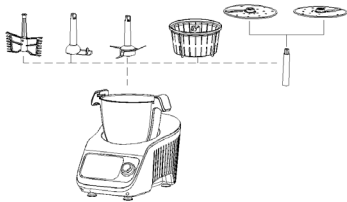

Choose difference accessories for difference cooking purpose

4

Add the ingredients or water to the jug .If need food processor function . Then you need to attach food processor lid and put ingredients directly through food dispenser

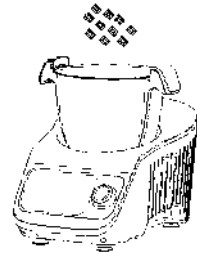

5



Attach the Blend lid, or FP lid or Steamer

6

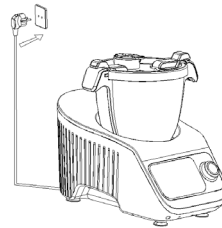

Plug your Power cord into the main base then, Switch on. When main base has the Power cord ,not assemble the Power cord

7





Slide the corresponding icon or rotate the knob to set the temperature, time and speeds. Click the minute or second in the time icon to quickly set the exact time. Reverse function: Click the icon  for shift rotating direction

8



Click  after set the temperature, time and speed to start, then the icon will change to , the machine is working now.

Click  or push button in knob to pause working, click  or continuously press the push button in knob to stop working and exit the program.

9

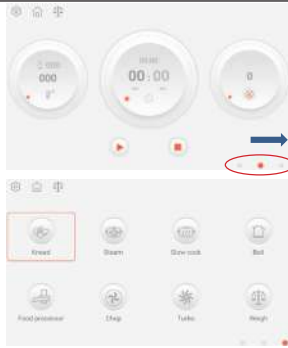

By sliding right direction in screen or click the right dot in red circle or turn the knob in clockwise to go to common function menu. Click the or click the middle dot in red circle to go back to the initial step for reset.

10



Click the function icon in common function menu to go to the corresponding screen interface. Start working after completing the step 7 and 8. Click to exit this interface. This icon is for steaming.

11

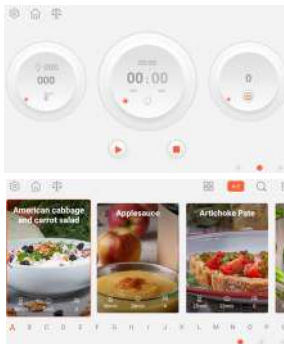

By sliding left in screen or click the left dot in red circle or turn the knob in anticlockwise to go to recipe menu. Click the or click the middle dot in red circle to go back to the initial step for reset.

12



Click the recipe photo, enter into recipe interface, click to check all the recipe details. Click to start and for favorite collection.

13



The recipe has preset parameter. Click to start. The number in red circle stand for each working step, click to check all the recipe details.



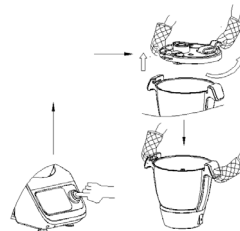



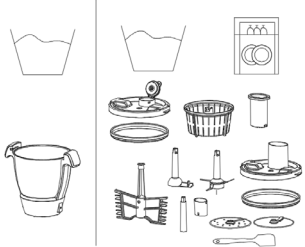
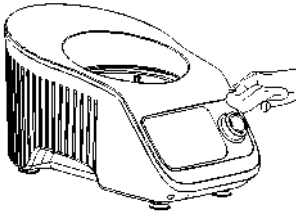





14



















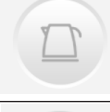



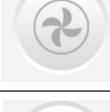

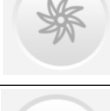

After cooking, Screen will shows end. Press the rotary knob and it will stop cooking. If you want to suspend during cooking. Press the rotary knob. Then press again and the cooker will continue cooking. The cooker will stop cooking if you long press the rotary knob.

<p>15</p>  <p>Accessories which can put into dishwasher</p>	<p>16</p>  <p>Clean the main unit</p>
--	---

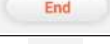
6. Control Panel Overview

Serial number	Icon	Function description
12		<p>(1) Can be used to setting temperature ,time, speed or UI, Auto program, recipe. (2) Press the knob and the cooker will suspend when cooking .It will continue cooking if your press again. Or confirm your choice. (3) Long push the knob and the cooker will stop cooking. (4) Press the knob after finish all setting and the cooking will start cooking. (5) It will automatically cancel if you long push the knob during setting. (6) When finish cooking, Press the knob and the cooker will into standby mode.</p>
27.1		<p>Reverse The speed rang:1-3</p>
27.2		<p>Speed: Click  to shift between clockwise and reverse Speed range:0-12</p>
26		<p>Display set time parameter:0-90 minute Operation time display: 0-90 minute</p>
25.1		<p>Display set temp parameter Temp rang: 37-120°C After 37, 40°C, in intervals of 5°</p>
25.2		<p>Close/Open Icon</p>
25.3		<p>Food /ingredients temp, After 37, 40°C, in intervals of 5°</p>
28		<p> : Start,  : Pause,  : Stop Button</p>
30		<p>Setup Button: set or check robot cook info including: Wifi, System version, Language etc.</p>

31		Home button: Home page	
32		Weight button	
33.1		Knead: Time: 3 (Range:2-4) minutes Temp: 000 (Range:000-37) °C Speed: 2 (Range:1-3)	
33.2		Steam: Time: 20 (Range:1-60) minutes Steam flow: Fast/Medium/Slow Time count down starts from 95 °C	
33.3		Slow Cook Time: 60 (Range:10-90) minutes Temp: 100 (Range:60-100) °C Speed: 1 (Range:1-3)	
33.4		Boil Temp: 100(Range:60-100) °C	
33.5		Food Processor Time: 30 (Range:10-60) seconds Speed: 5 (Range: 5-7)	
33.6		Chop Time: 10s (Range:10s-4m) Speed: 6 (Range:1-12)	
33.7		Turbo Time:60s Speed: 12 Press  or Press Knob and release to stop	
33.8		Weigh Max: 5Kgs 5g interval	
33.8.1		Tare	
33.8.2		End weighing	
34		Sort management	
35		A-Z	
36		search	

37		More Including favorite collection and history
44		Exit
45		Favorite/History
46		Ingredients Picto
47		Cooking step
48		Chef's tips
49		Accessories Picto
50		Check recipe info including

7. Setting the time

7.1: Time range: 0-90 minutes

7.2: Click , click min or sec, slide or rotate the knob to set time

8. Setting the temperature

8.1: Temperature range: 37-120°C, with 5°C interval

8.2: Click , slide the picto or rotate the knob to set the temp

9. Setting the speed

9.1: Speed range: 0-12

9.2: Click , slide the picto or rotate the knob to set the speed

9.3 : Click , shift to , with speed setting 1-3

9.4: Speed 1-3:

Speed 1-4:

Speed 1-12

10. Start, pause and stop

10.1 Start

10.2 Pause

10.3 Stop

During standby mode, white and red lights flash. Red light underneath Knob is on when temperature is beyond 60°C, and white light is on when temperature is below 60°C, at any working mode

11. Suggested Usage

Method				
Function	Accessory	Speed	Time	Maximum cooking ingredients in one time
Meat Chopping	Chopping blade	Speed 8-12	30s-60s	600g Beef / pork without bone/tendon
Ice Crush	Chopping Blade	Speed 8-12	10-20s	600g ice cube
Blender	Chopping Blade	Speed 12	1min	Maximum Capacity: 2300ml 920g carrot 1380g water
Chopping (Onion, shallot, celery, etc)	Chopping Blade	Speed 5	15s-30s	500g
Kneading	Chopping Blade	Speed 1	2mins	500g flour + 250g water + 20g oil
Slices, Shreds (Carrot, cucumber, potato)	Slices discs	Speed 5-6	30s	500g
Soup	Stir paddle	Speed 1	Choose Soup function. Or you can setting the proper time , speed, temperature by your own.	Maximum Capacity 2000ml

12. Care and Cleaning:

12.1. Always switch off and unplug before cleaning.

12.2. Remove the lid and tool from the bowl before cleaning,

12.3. Power unit. Wipe with a damp cloth, then dry. Never use abrasives or immerse in water.

12.4. When there is burn mark on blender jug bottom, put some citric acid or lemons into water, heat 5~7 minutes, then remove the burn mark with a mop



12.5. Bowl/stirring paddle/blade. Wash the parts, then dry thoroughly. If food sticks or burns on the inside of the bowl, remove as much as possible using a spatula. Fill the bowl with warm soapy water and allow to soak. Remove any stubborn deposits using a cleaning brush. Any discolouration of the bowl will not affect its performance.

12.6. How to take out steam basket

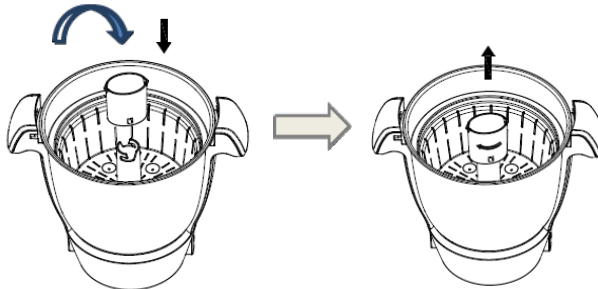
Put measuring cup into steam basket slot and rotate to fix. Then, take out.

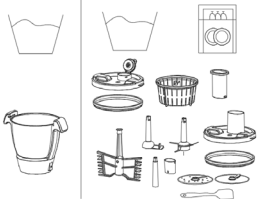

13. Cleaning and Maintenance

<p>Please unplug the power cord before cleaning</p>	<p>Please use dry dishcloth to clean the main unit .Do not wash them with water or put it into the dish-washing machine.</p>
<p>Lid, Measuring cup, Blade, Mixing paddle, Steam basket, Steamer etc. All above photo accessories can be washed by dish-washing machine.</p> 	<p>Metal brush, nylon brush, household cleaner, diluent, cleaning products will damage the surface of product structure</p> 
<p>Please use dry and soft cloth to clean power cord .</p>	

14. Product Specification

Model: SS-14565
Rated Voltage: 220-240V~ 50-60Hz
Heating Power: 1000W
Mixing Power: 600W
Bowl Capacity: 2.0L/3.5L (Max)
Heating Power + Mixing Power: 1300W





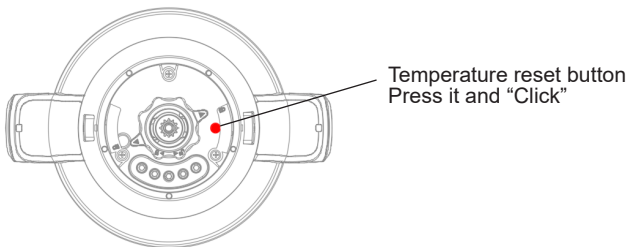

15. Reset temperature control

If the machine stops working due to over temperature, you can press the temperature reset button located at the bottom of the jug. Make sure that the jug cools down and then make it work again.

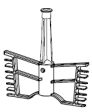

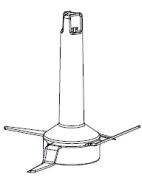
JUG BOTTOM VIEW

16. Accessories Overview

Key Part		Function	Speed	Time	Temperature°C
	Whisk	Whip Egg white	4	2-4 minutes	---
		Whip Cream	3	3-5 minutes	---
	Stirring paddle	Soup	1-2	1-90 minutes	100°C
		Other ingredients that need to heat	1-2	As per need	As per need
	Blade	Meat Chopping	8-12	30-60s	---
		Ice Crush Sugar	8-12	10-20s	--
		Blender	8-12	1-2 minutes	---
		Chopping (Onion, Shallot, Celery etc)	5-7	15-60s	---
		Bean, Soybean, nut, peanut, coffee bean, almond	12	2-3 minutes	---
		Kneading	1	1-2 minutes	--
	Steam basket	Rice etc.	12	20-30 minutes	100-110°C
	Slicer/shred disc	Slices	5-6	30-60s	--
	Steamer	Fish...	---	10-60 minutes	110-120°C

Ce manuel d'instructions peut également être téléchargé à partir de notre page Web
www.sogo.es

Lire attentivement ces instructions avant d'utiliser le produit

1. Lisez attentivement ces instructions et conservez-les pour référence ultérieure.
2. Éteignez l'appareil et débranchez-le de l'alimentation avant de changer les accessoires ou de vous approcher des pièces qui bougent pendant l'utilisation.
3. Gardez les parties du corps, les bijoux et les vêtements amples à l'écart des pièces mobiles et des outils / accessoires montés.
4. Retirez toujours la lame avant de verser le contenu du bol.
5. Gardez les mains et les ustensiles hors du bol pendant qu'ils sont connectés à l'alimentation électrique.
6. N'utilisez jamais un appareil endommagé. Faites-le vérifier ou réparer.
7. Ne dépassez pas le niveau de remplissage maximum indiqué à l'intérieur du bol.
8. Ne laissez jamais le bloc d'alimentation, le cordon ou la fiche se mouiller.
9. Soyez prudent lorsque vous manipulez ou touchez une partie quelconque de l'appareil lorsqu'il est utilisé en mode de cuisson ou après la cuisson. En particulier la cuve, le couvercle et les outils, car ils resteront CHAUDS longtemps après l'arrêt de l'appareil.
10. Utilisez les poignées pour retirer et transporter le bol. Utilisez des gants de cuisine pour manipuler le bol chaud et les outils chauds.

11. Le dessous du bol restera chaud longtemps après l'arrêt du chauffage. Soyez prudent lorsque vous manipulez et utilisez un tapis de protection de surface de travail lorsque vous placez le bol sur des surfaces sensibles à la chaleur.
12. Soyez prudent avec la vapeur qui s'échappe du bol, en particulier lorsque vous retirez le couvercle ou le bouchon de remplissage.
13. Ne retirez pas le couvercle ou le bouchon de remplissage pendant que le liquide bout.
14. Fermez toujours le bouchon de remplissage lorsque vous utilisez la fonction de hachage.
15. Utilisez uniquement le bol et les outils fournis avec cet appareil. N'utilisez jamais le bol avec une autre source de chaleur..
16. Ne faites jamais fonctionner l'appareil en mode de cuisson avec le bol vide.
17. N'utilisez pas le couvercle du mixeur pour faire fonctionner le processeur. Cet appareil sera endommagé et peut provoquer des blessures si le mécanisme de verrouillage est soumis à une force excessive.
18. Lorsque vous utilisez cet appareil, assurez-vous qu'il est positionné sur une surface plane, loin du bord. Ne pas placer sous des armoires en surplomb.
19. Pour un fonctionnement correct et sûr, assurez-vous que la base du bol et les capteurs de température sont propres et secs avant la cuisson.
20. **ATTENTION: Afin d'éviter tout danger dû à une réinitialisation accidentelle de la coupure thermique, cet appareil ne doit pas être alimenté par un dispositif de commutation externe, comme une minuterie, ou connecté**

à un circuit qui est régulièrement allumé et éteint.

21. Assurez-vous toujours que les aliments sont bien cuits et bien chauds avant de les manger.
22. Les aliments doivent être consommés peu de temps après la cuisson ou refroidis rapidement, puis réfrigérés dès que possible.
23. Une mauvaise utilisation de votre appareil peut entraîner des blessures.
24. Les appareils peuvent être utilisés par des personnes ayant des capacités physiques, sensorielles ou mentales réduites ou manquant d'expérience et de connaissances si elles ont reçu une supervision ou des instructions concernant l'utilisation de l'appareil de manière sûre et si elles comprennent les risques encourus.
25. Les enfants ne doivent pas jouer avec l'appareil.
26. Cet appareil ne doit pas être utilisé par des enfants. Gardez l'appareil et son cordon hors de portée des enfants. Ne laissez jamais le cordon pendre là où un enfant pourrait le saisir.
- 27. Avertissement: Soyez prudent lorsque vous manipulez les lames tranchantes, videz le bol et pendant le nettoyage.**
28. Débranchez toujours l'appareil de l'alimentation s'il est laissé sans surveillance et avant le montage, le démontage ou le nettoyage.
29. Si le câble d'alimentation est endommagé, il doit être remplacé par un câble spécial disponible auprès du fabricant ou de son agent de service afin d'éviter tout danger
30. N'utilisez l'appareil que pour l'usage domestique auquel il est destiné. Nous déclinons toute responsabilité si l'appareil est soumis à une

mauvaise utilisation ou au non-respect de ces instructions.

31. La charge maximale pour la fonction de mélange est de 920 g de carottes / 1380 g d'eau
32. Soyez prudent si du liquide chaud est versé dans le robot culinaire ou le mélangeur, car il peut être éjecté de l'appareil en raison d'une vapeur soudaine.
33. L'appareil ne doit être utilisé qu'avec le support fourni.
34. L'appareil est destiné à un usage domestique et intérieur uniquement.
35. Évitez de renverser sur le connecteur.
36. Ne démontez pas la base de la tasse (y compris le boîtier de la poignée), ce n'est pas pour la maintenance de l'utilisateur.
37. Une fois que le moteur a cessé de fonctionner (le cas échéant), le ventilateur de refroidissement continue de fonctionner pendant encore 2 minutes

38. Les surfaces sont susceptibles de chauffer pendant l'utilisation.



39. Pour savoir comment nettoyer les surfaces en contact avec les aliments, reportez-vous au paragraphe Entretien et nettoyage.

40. ATTENTION: Assurez-vous que l'appareil est éteint avant de le retirer du support.

Avant de brancher

Assurez-vous que votre alimentation électrique est la même que celle indiquée sur le dessous de votre appareil.

AVERTISSEMENT: CET APPAREIL DOIT ÊTRE MIS À LA TERRE

1. Aperçu du produit

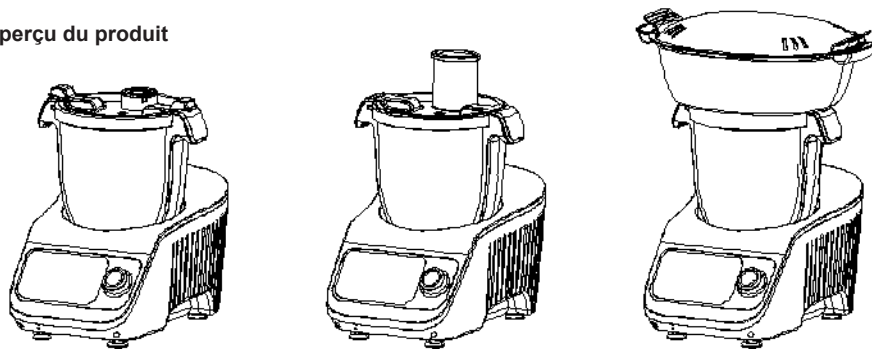

2. Pièces

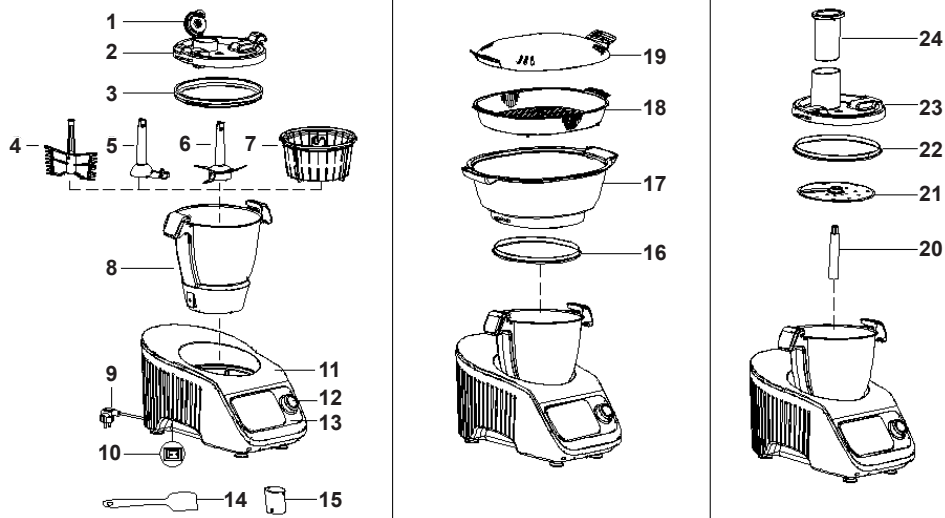

3. Écran d'affichage

1) IU DIY

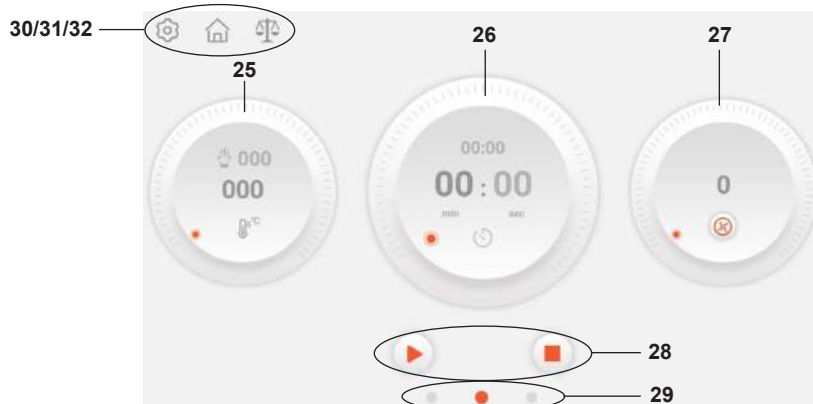

2) Programmes automatiques IU

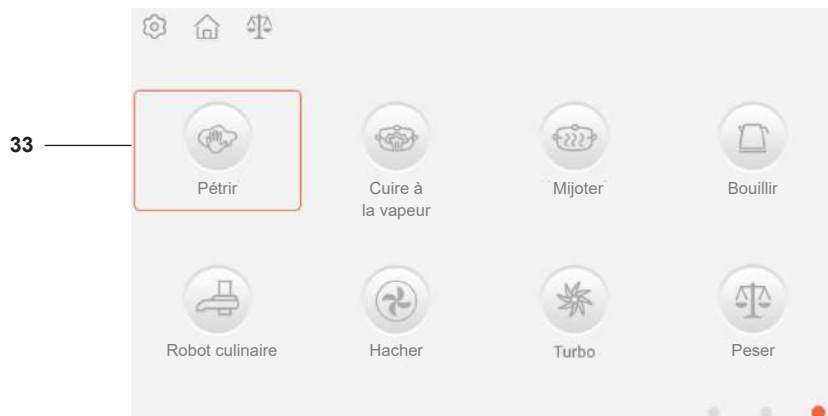

3) Recette IU

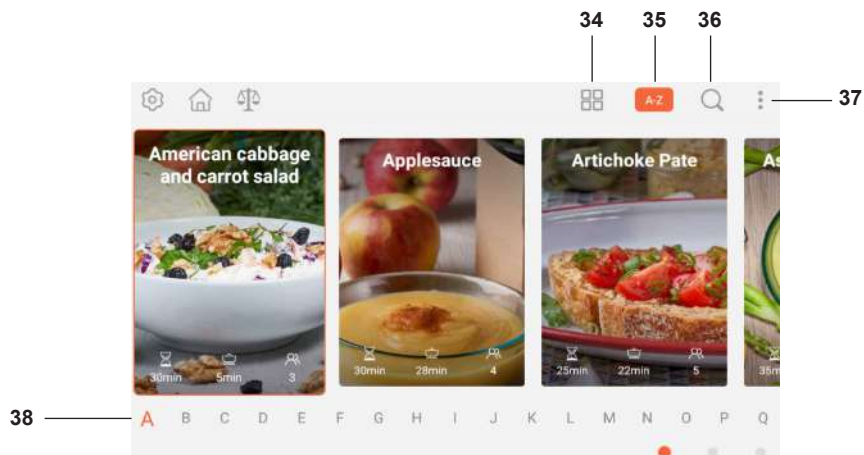

4) Configuration IU



5) Accueil UI



4. Pièces clés

No.	Nom	No.	Nom	No.	Nom
1	Bouchon de remplissage	16	Sceau de panier à vapeur profonde	31	Bouton Accueil
2	Couvercle du mélangeur	17	Panier vapeur, profond	32	Bouton de poids
3	Joint du couvercle du mélangeur	18	Panier vapeur, peu profond	33	Bouton de fonction
4	Époussette	19	Couvercle pour panier vapeur	34	Trier la gestion
5	Pagaie d'agitation	20	Arbre d'entraînement	35	A-Z
6	Lame	21/21A	Trancheuse / déchiqueter	36	Bouton de recherche
7	Panier vapeur	22	Joint pour couvercle FP	37	Bouton Plus
8	Pichet mélangeur	23	Couvercle FP	38	Bouton A-Z
9	Cordon d'alimentation	24	Pousseur	39	Configurer IU
10	Interrupteur principal	25	Bouton de température	40	Recettes IU
11	Unité de base	26	Bouton minuterie	41	DIY IU
12	Bouton	27	Bouton de vitesse	42	Programme automatique IU
13	Écran d'affichage	28	Bouton démarrer / Pause / Arrêt	43	Télécharger IU
14	Spatule	29	Point de décalage d'interface		
15	Tasse à mesurer	30	Bouton de configuration		

5. À configurer avant utilisation

1

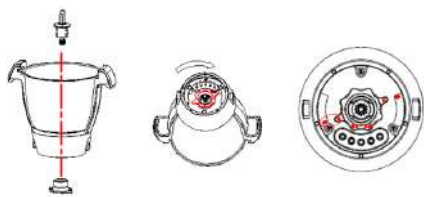

Placer l'arbre d'entraînement correctement verrouillé dans la verseuse.

2



Insérez la verseuse dans l'unité principale. Appuyez fermement pour verrouiller en place. (LOGO à l'avant, Max à l'arrière)

3

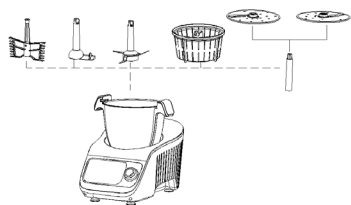

Choisissez différents accessoires pour différents usages de cuisson.

4

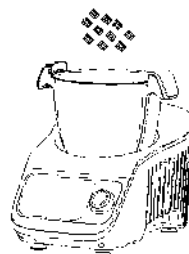

Ajoutez des ingrédients ou de l'eau dans la verseuse. Si vous avez besoin de la fonction du robot culinaire, fixez le couvercle du robot culinaire et placez les ingrédients directement dans.

5

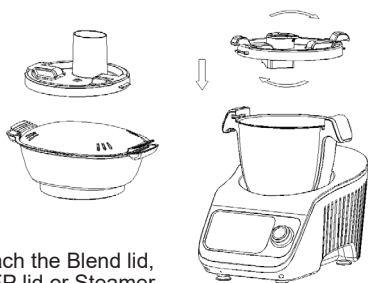

Attach the Blend lid, or FP lid or Steamer.

6

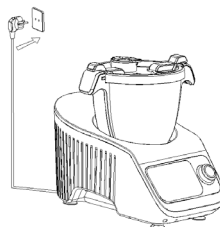

Branchez le cordon d'alimentation sur la base principale, puis allumez-le. Lorsque la base principale est dotée du cordon d'alimentation, n'assemblez pas le cordon d'alimentation.

7



Faites glisser l'icône correspondante ou tournez le bouton pour régler la température, l'heure et la vitesse. Cliquez sur la minute ou la seconde dans l'icône de l'heure pour régler rapidement l'heure exacte. Fonction d'inversion: cliquez sur l'icône ► pour changer le sens de rotation

8



Cliquez sur ► après avoir réglé la température, l'heure et la vitesse pour démarrer, puis l'icône passera à ||, la machine

Cliquez ou appuyez sur le bouton || dans le bouton pour suspendre le travail, cliquez sur ■ ou appuyez continuellement sur le bouton poussoir dans le bouton pour arrêter de

9



Glissant vers la droite sur l'écran ou en cliquant sur le point droit dans le cercle rouge ou en tournant le bouton dans le sens des aiguilles d'une montre, vous accédez au menu des fonctions communes. Cliquez sur ou cliquez sur le point central dans le cercle rouge pour revenir à l'étape initiale de réinitialisation.

10



Cliquez sur l'icône de fonction dans le menu des fonctions communes pour accéder à l'interface d'écran correspondante. Commencez à travailler après avoir terminé les étapes 7 et 8. Cliquez sur pour quitter cette interface. Cette icône sert à la vapeur.

11

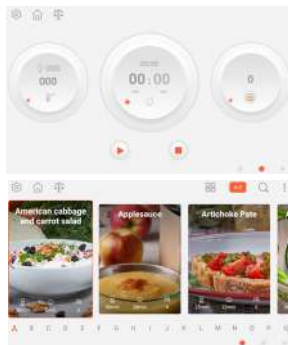

En glissant à gauche sur l'écran ou en cliquant sur le point gauche dans le cercle rouge ou en tournant le bouton dans le sens inverse des aiguilles d'une montre, vous accédez au menu de la recette. Cliquez sur le ou cliquez sur le point central dans le cercle rouge pour revenir à l'étape initiale de réinitialisation.

12



Cliquez sur la photo de recette, entrez dans l'interface de recette, cliquez sur

pour vérifier tous les détails de la recette. Cliquez sur pour commencer et pour la collection préférée.

13



La recette a des paramètres prédéfinis. Cliquez sur pour commencer. Le nombre dans le cercle rouge représente chaque étape de travail, cliquez sur pour vérifier tous les détails de la recette.

14

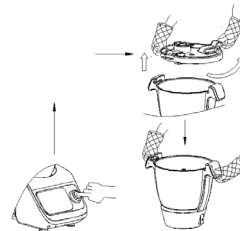

Après la cuisson, l'écran affichera Fin. Appuyez sur le bouton rotatif et il arrêtera la cuisson. Si vous souhaitez suspendre pendant la cuisson, appuyez sur le bouton rotatif. Appuyez ensuite de nouveau sur et la cuisinière continuera la cuisson. La cuisinière arrêtera la cuisson si vous appuyez longuement sur le bouton rotatif.

15

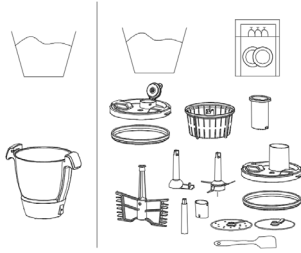

Accessoires pouvant être mis au lave-vaisselle.



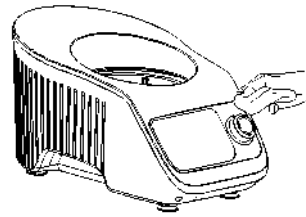









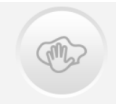









16



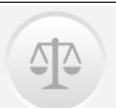







Nettoyez l'unité principale

6. Présentation du panneau de commande

Numéro de série	Icône	Description de la fonction
12		(1) Peut être utilisé pour régler la température, le temps, la vitesse; ou IU, programme automatique, recette. (2) Appuyez sur le bouton et la cuisinière suspendra la cuisson. Elle continuera la cuisson si vous appuyez à nouveau. Ou confirmez votre choix. (3) Appuyez longuement sur le bouton et la cuisinière arrêtera la cuisson. (4) Appuyez sur le bouton après avoir terminé tous les réglages et la cuisson commencera la cuisson. (5) Il s'annulera automatiquement si vous appuyez longuement sur le bouton pendant le réglage. (6) Une fois la cuisson terminée, appuyez sur le bouton et la cuisinière se mettra en veille.
27.1		Inverser Plage de vitesse: 1-3
27.2		Vitesse: cliquez sur pour basculer entre le sens horaire et l'inverse Plage de vitesse: 0-12
26		Affichage du paramètre de temps défini: 0-90 minutes Affichage du temps de fonctionnement: 0-90 minutes
25.1		Affichage du paramètre de température réglé Plage de température: 37-120 °C Après 37, 40 °C, par intervalles de 5 °
25.2		Icône Fermer / Ouvrir
25.3		Température aliments / ingrédients: Après 37, 40 °C, par intervalles de 5 °
28		: bouton démarrer , : pause, : arrêt
30		Bouton de configuration: définissez ou vérifiez les informations de cuisson du robot, y compris: Wifi, version du système, langue, etc.

31		Bouton Accueil: page d'accueil	
32		Bouton de poids	
33.1		Pétrir: Durée: 3 (plage: 2-4) minutes Temp: 000 (plage: 000-37) °C Vitesse: 2 (plage: 1-3)	
33.2		Vapeur: Durée: 20 (plage: 1-60) minutes Débit de vapeur: rapide / moyen / lent Le compte à rebours commence à partir de 95 °C	
33.3		Cuisson lente Durée: 60 (plage: 10-90) minutes Temp: 100 (plage: 60-100) °C Vitesse: 1 (plage: 1-3)	
33.4		Ébullition Temp: 100 (plage: 60-100) °C	
33.5		Robot culinaire Durée: 30 (plage: 10-60) secondes Vitesse: 5 (plage: 5-7)	
33.6		Hacher Durée: 10s (plage: 10s-4m) Vitesse: 6 (plage: 1-12)	
33.7		Turbo Temps: 60s Vitesse: 12 Appuyez sur  ou Appuyez sur le bouton et relâchez-le pour arrêter	
33.8		Peser Max: 5Kgs Intervalle de 5g	
33.8.1		Tare	
33.8.2		Pesée finale	
34		Gestion du tri	
35		A-Z	
36		Chercher	

37		Plus Y compris la collection et l'histoire préférées
44		Sortie
45	 	Favoris / Histoire
46		Ingrédients Picto
47		Étape de cuisson
48		Conseils du chef
49		Accessoires Picto
50		Vérifiez les informations sur la recette, y compris

7. Réglage de l'heure

7.1: Plage de temps: 0-90 minutes

7.2: Cliquez sur  , cliquez sur min ou sec, faites glisser ou tournez le bouton pour régler l'heure

8. Réglage de la température



8.1: Plage de température: 37-120 °C, avec intervalle de 5°C

8.2: Cliquez sur  faites glisser le picto ou tournez le bouton pour régler la température

9. Réglage de la vitesse

9.1: Plage de vitesse: 0-122

9.2: Cliquez  , faites glisser le picto ou tournez le bouton pour régler la vitesse

9.3  : Cliquez sur  , passez à  , avec le réglage de vitesse 1-3

9.4:  vitesse 1-3:

 vitesse 1-4:

 vitesse 1-12

10. Démarrer, pause et arrêter

10.1  Démarrer

10.2  Pause

10.3  Arrêter

En mode veille, les lumières blanches et rouges clignotent. La lumière rouge sous le bouton est allumée lorsque la température dépasse 60°C, et la lumière blanche est allumée lorsque la température est inférieure à 6°C, quel que soit le mode

11. Utilisation suggérée

Méthode				
Fonction	Accessoire	Vitesse	Temps	Ingrédients de cuisson maximum en une seule fois
Hacher la viande	Lame à découper	Vitesse 8-12	30s-60s	600 g Boeuf / porc sans os / tendon
Écrasement de glace	Lame à découper	Vitesse 8-12	10-20s	600 g de glaçon
Mixeur	Lame à découper	Vitesse 12	1min	Capacité maximale: 2300 ml 920g de carotte 1380g d'eau
Hacher (Oignon, échalote, céleri, etc.)	Lame à découper	Vitesse 5	15s-30s	500g
Pétrissage	Lame à découper	Vitesse 1	2mins	500 g de harina + 250 g de agua + 20 g de aceite
Tranches, lambeaux (Carotte, concombre, pomme de terre)	Disques de tranchage	Vitesse 5-6	30s	500g
Soupe	disques de tranchage	Vitesse 1	Choisissez la fonction Soupe. Ou vous pouvez régler vous-même l'heure, la vitesse et la température appropriées.	Capacité maximale 2000 ml

12. Entretien et nettoyage:

12.1. Toujours éteindre et débrancher avant de nettoyer.

12.2. Retirez le couvercle et l'outil du bol avant le nettoyage,

12.3. Bloc d'alimentation. Essuyez avec un chiffon humide, puis séchez. Ne jamais utiliser d'abrasifs ni plonger dans l'eau.



12.4. Lorsqu'il y a une marque de brûlure sur le fond du bol du mélangeur, mettez de l'acide citrique ou des citrons dans de l'eau, chauffez pendant 5 à 7 minutes, puis retirez la marque de brûlure avec une vadrouille
 12.5. Bol / palette agitatrice / lame. Laver les pièces, puis sécher soigneusement. Si de la nourriture ou des brûlures collent à l'intérieur du bol, retirez-les autant que possible à l'aide d'une spatule. Remplissez le bol d'eau chaude savonneuse et laissez tremper. Retirez tous les dépôts tenaces à l'aide d'une brosse de nettoyage. Toute décoloration du bol n'affectera pas ses performances.

12.6. Comment retirer le panier vapeur

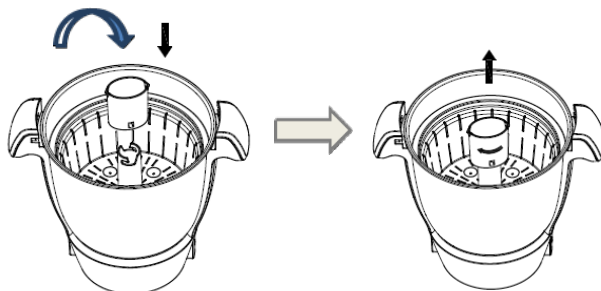
Placez la tasse de mesure dans la fente du panier à vapeur et tournez pour la fixer. Ensuite, sortez.

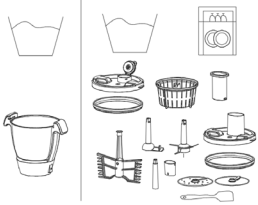

13. Nettoyage et entretien

Veuillez débrancher le cordon d'alimentation avant de nettoyer	Veuillez utiliser un torchon sec pour nettoyer l'unité principale. Ne pas laver à l'eau ni mettre au lave-vaisselle.
<p>Couvercle, tasse à mesurer, lame, palette pour mélanger, panier à vapeur, vapeur, etc. Tous les accessoires de l'image ci-dessus peuvent être lavés avec un lave-vaisselle.</p> 	<p>Une brosse métallique, une brosse en nylon, un nettoyant ménager, un diluant, des produits de nettoyage, etc. endommageront la surface de la structure du produit</p> 
Veuillez utiliser un chiffon sec et doux pour nettoyer le cordon d'alimentation.	

14. Spécifications du produit

Modèle: SS-14565

Tension nominale: 220-240V~ 50-60Hz

Puissance de chauffage: 1000W

Puissance de mélange: 600W

Capacité du bol: 2.0L/3.5L(Max)

Puissance de chauffage + Puissance de mélange: 1300W

15. Réinitialiser le contrôle de la température



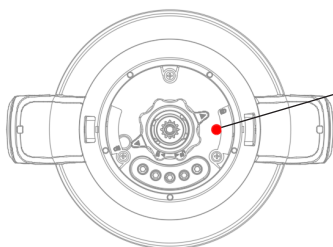



Si la machine cesse de fonctionner en raison d'une surchauffe, vous pouvez appuyer sur le bouton de réinitialisation de la température situé au bas de la verseuse. Assurez-vous que la verseuse refroidit, puis faites-la fonctionner à nouveau.

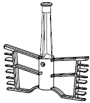

Bouton de réinitialisation de la température
Appuyez dessus et cliquez

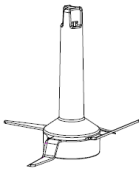
**VUE DE DESSOUS
DE CRUCHE**

16. Présentation des accessoires

Élément clé	Fonction	Vitesse	Temps	Température°C	
	Fouetter	Fouetter blanc d'oeuf	4	2-4 minutes	---
		Fouetter la crème	3	3-5 minutes	---
	Palette d'agitation	Soupe	1-2	1-90 minutes	100°C
		Autres ingrédients qui doivent être chauffés	1-2	Selon besoin	Selon besoin
	Lame	Hacher la viande	8-12	30-60s	---
		Sucre pilé	8-12	10-20s	--
		Mixeur	8-12	1-2 minutes	---
		Hacher (Oignon, chalote, céleri, etc.)	5-7	15-60s	---
		Haricot, soja, noix, arachide, Grain de café, amande	12	2-3 minutes	---
		Pétrissage	1	1-2 minutes	--
	Panier vapeur	Riz etc.	---	20-30 minutes	100-110°C
	Disque à trancher / déchiqueter	Tranches	5-6	30-60s	--
	Vapeur	Poisson...	---	10-60 minutes	110-120°C

Este manual de instruções também pode ser baixado da nossa página web **www.sogo.es**

Por favor, leia estas instruções cuidadosamente antes de usar o produto

1. Leia estas instruções cuidadosamente e guarde-as para referência futura.
2. Desligue o aparelho e desconecte-o da fonte antes de trocar os acessórios ou se aproximar das peças que se movem quando em uso.
3. Mantenha as partes do corpo, jóias e roupas folgadas afastadas de peças móveis e ferramentas / acessórios.
4. Remova sempre a lâmina antes de derramar o conteúdo da tigela.
5. Mantenha as mãos e os utensílios fora da tigela enquanto estiver conectado à fonte de alimentação.
6. Nunca use um aparelho danificado. Verifique ou conserte.
7. Não exceda o nível máximo de enchimento marcado no interior da tigela.
8. Nunca deixe a unidade de alimentação, o cabo ou o plugue se molhar.
9. Tenha cuidado ao manusear ou tocar em qualquer parte do aparelho quando estiver sendo usado no modo de cozimento ou após o cozimento. Em particular a tigela, a tampa e as ferramentas, pois permanecerão **QUENTES** muito tempo depois que o aparelho foi desligado.
10. Use as alças para remover e transportar a tigela. Use luvas de forno ao manusear a tigela quente e as ferramentas quentes.
11. A parte de baixo da tigela permanecerá quente

por muito tempo após o aquecimento parar. Tenha cuidado ao manusear e use um tapete de proteção da superfície de trabalho ao colocar a tigela em superfícies sensíveis ao calor.

12. Tenha cuidado com o vapor que sai da tigela, principalmente ao remover a tampa ou a tampa de abastecimento.
13. Não remova a tampa ou a tampa de enchimento enquanto o líquido estiver fervendo.
14. Sempre feche a tampa de abastecimento ao usar a função de corte.
15. Use apenas a tigela e as ferramentas fornecidas com este aparelho. Nunca use a tigela com qualquer outra fonte de calor.
16. Nunca opere o aparelho no modo de cozinhar com a tigela vazia.
17. Não use a tampa do liquidificador para operar o processador. Este aparelho será danificado e poderá causar ferimentos se o mecanismo de intertravamento for sujeito a força excessiva.
18. Ao usar este aparelho, verifique se está posicionado em uma superfície nivelada, longe da borda. Não posicione abaixo dos armários pendentes.
19. Para a operação correta e segura, verifique se a base do recipiente e os sensores de temperatura estão limpos e secos antes de cozinhar.
20. **CUIDADO: Para evitar um risco devido a reinicialização inadvertida do corte térmico, este aparelho não deve ser fornecido através de um dispositivo de comutação externo, como um temporizador, ou**

conectado a um circuito que é ligado e desligado regularmente pelo utilitário.

21. Verifique sempre se os alimentos estão bem cozidos e bem quentes antes de comer.
22. Os alimentos devem ser consumidos logo após o cozimento ou devem esfriar rapidamente e depois refrigerados o mais rápido possível.
23. O uso incorreto do seu aparelho pode resultar em ferimentos.
24. Os aparelhos podem ser usados por pessoas com capacidades físicas, sensoriais ou mentais reduzidas ou com falta de experiência e conhecimento se eles receberem supervisão ou instruções sobre o uso do aparelho de maneira segura e se compreenderem os riscos envolvidos.
25. As crianças não devem brincar com o aparelho.
26. Este aparelho não deve ser utilizado por crianças. Mantenha o aparelho e o fio fora do alcance de crianças. Nunca deixe o fio pendurado onde uma criança possa segurá-lo.
- 27. Aviso: Tenha cuidado ao manusear as lâminas cortantes afiadas, esvaziando a tigela e durante a limpeza.**
28. Sempre desconecte o aparelho do suprimento se ele for deixado sem vigilância e antes da montagem, desmontagem ou limpeza.
29. Se o cabo de alimentação estiver danificado, ele deve ser substituído por um conjunto de cabos especial disponível no fabricante ou em seu agente de serviço para evitar riscos.
30. Utilize o aparelho apenas para o uso doméstico pretendido. Não assumimos qualquer responsabilidade se o aparelho estiver sujeito a uso inadequado ou falha no cumprimento

destas instruções.

31. A carga máxima para a função de mistura é 920 g de cenoura / 1380 g de água
32. Tenha cuidado se for derramado líquido quente no processador de alimentos ou no liquidificador, pois ele pode ser ejetado do aparelho devido a vapor repentino.
33. O aparelho deve ser utilizado apenas com o suporte fornecido.
34. O aparelho é apenas para uso doméstico e interno.
35. Evite derrames no conector.
36. Não desmonte a base do copo (incluindo o gabinete da alça), não é para manutenção do usuário.
37. Depois que o motor parar de funcionar, o ventilador continuará funcionando por mais 2 minutos
38. **As superfícies podem esquentar durante o uso.** 
39. Para saber como limpar as superfícies em contato com os alimentos, consulte o parágrafo Cuidados e limpeza.
40. **CUIDADO: Verifique se o aparelho está desligado antes de removê-lo do suporte. Antes de conectar Verifique se o seu suprimento de eletricidade é igual ao mostrado na parte inferior do seu aparelho.**
AVISO: ESTE APARELHO DEVE TER A TERRA.

1. Visão geral do produto

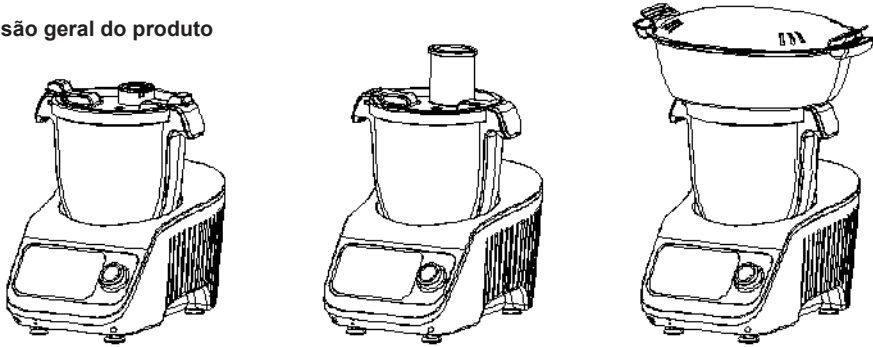

2. Peças

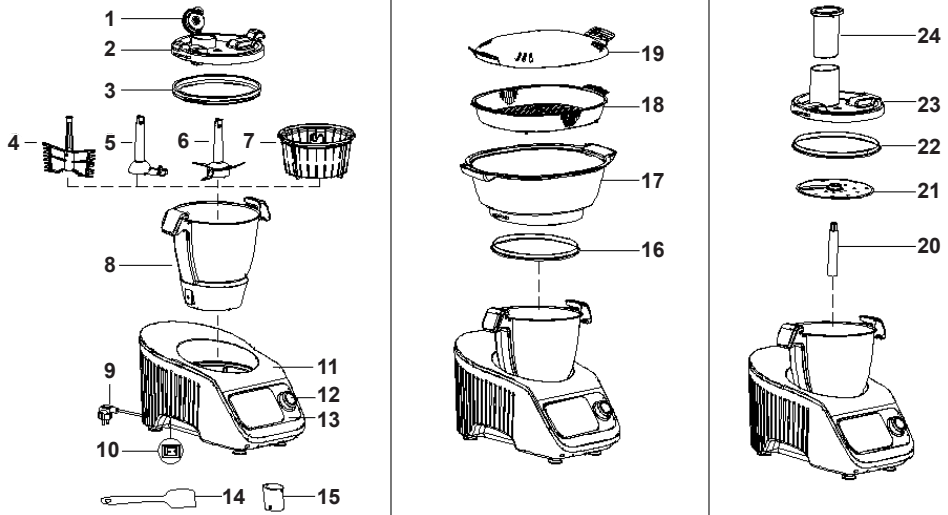

3. Tela de exibição

1) Interface do usuário DIY

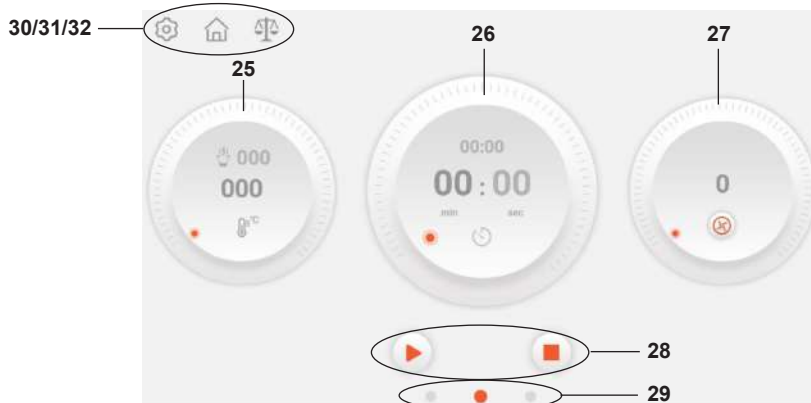

2) IU de programas automáticos



3) Receita IU

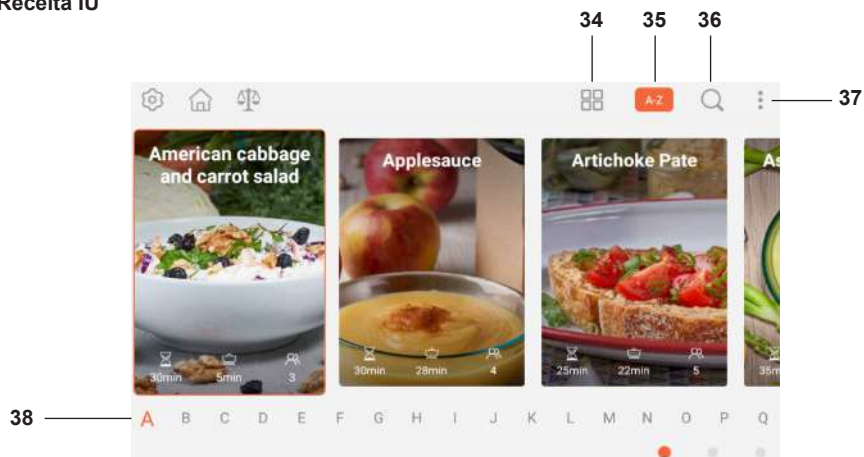

4) Configuração da IU

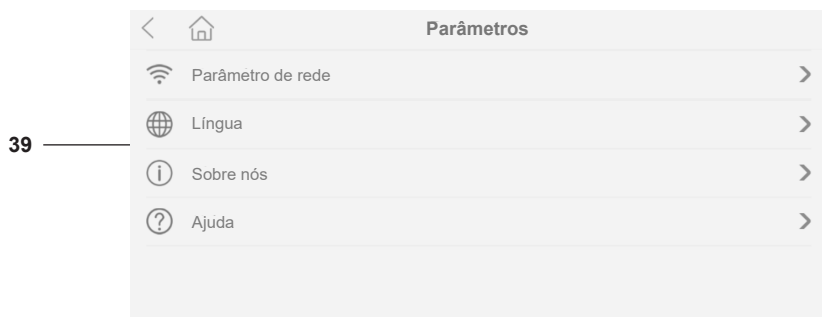







5) UI Início

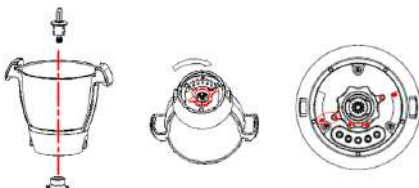

4. Peças-chave

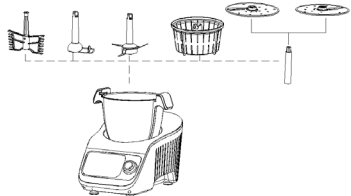
No.	Nome	No.	Nome	No.	Nome
1	Tampa de enchimento	16	Selo do cesto de vapor profundo	31	Botão Home
2	Tampa do liquidificador	17	Cesto de vapor, profundo	32	Botão de peso
3	Selo da tampa do liquidificador	18	Cesto de vapor, raso	33	Botão de Função
4	Sacudidela	19	Tampa para cesto a vapor	34	Gerenciamento de classificação
5	Remo de agitação	20	Eixo de acionamento	35	A-Z
6	Lâmina	21/21A	Fatiador / farrapo	36	Botão Pesquisar
7	Cesta de vapor	22	Vedação para tampa FP	37	Botão Mais
8	Jarro liquidificador	23	Tampa FP	38	Botão A-Z
9	Cabo de alimentação	24	Empurrador	39	Configuração IU
10	Interruptor principal	25	Botão de temperatura	40	Receitas IU
11	Unidade base	26	Botão do temporizador	41	DIY IU
12	Botão	27	Botão de velocidade	42	Programa automático IU
13	Tela de exibição	28	Botão Iniciar / Pausar / Parar	43	Baixar IU
14	Espátula	29	Ponto de mudança de interface		
15	Copo medidor	30	Botão de configuração		

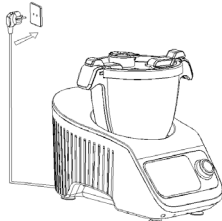
5. Para configurar antes de usar

<p>1</p>  <p>Coloque o eixo de acionamento corretamente travado no jarro.</p>	<p>2</p>  <p>Insira o jarro na unidade principal. Pressione firmemente para travar no lugar. (LOGO na frente, Max na parte de trás)</p>
<p>3</p>  <p>Escolha acessórios diferentes para diferentes fins de cozimento.</p>	<p>4</p>  <p>Adicione ingredientes ou água ao jarro. Se você precisar da função de processador de alimentos, conecte a tampa do processador de alimentos e coloque os ingredientes</p>
<p>5</p>  <p>Coloque a tampa de mistura, a tampa FP ou o navio a vapor</p>	<p>6</p>  <p>Conecte o cabo de alimentação na base principal e ligue-o. Quando a base principal tiver o cabo de alimentação, não o monte.</p>
<p>7</p>  <p>Deslize o ícone correspondente ou gire o botão para definir a temperatura, o tempo e a velocidade. Clique no ícone de minuto ou segundo no horário para definir rapidamente a hora exata. Função reversa: Clique no ícone ▶ para mudar a direção de rotação</p>	<p>8</p>  <p>Clique em ▶ depois de definir a temperatura, hora e velocidade para iniciar; o ícone mudará para ; a máquina está funcionando agora.</p> <p>Clique ou pressione o botão no botão para interromper o trabalho, clique em ■ ou pressione continuamente o botão no botão para parar de trabalhar e sair do programa.</p>

9



Deslizando para a direita na tela ou clicando no ponto direito no círculo vermelho ou girando o botão no sentido horário, você acessa o menu de funções comuns. Clique em  ou clique no ponto do meio no círculo vermelho para voltar à etapa inicial de redefinição.

10



Clique no ícone da função no menu de funções comuns para acessar a interface da tela correspondente. Comece a trabalhar depois de concluir as etapas 7 e 8. Clique em  para sair desta interface. Este ícone é para cozinhar a vapor.

11

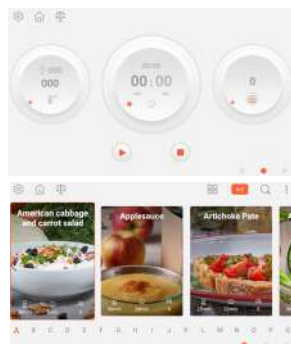





Deslizando para a esquerda na tela ou clicando no ponto esquerdo no círculo vermelho ou girando o botão no sentido anti-horário, você chegará ao menu de receitas. Clique no  ou clique no ponto do meio no círculo vermelho para voltar à etapa inicial de redefinição.

12





Clique na foto da receita, entre na interface da receita, clique em

   para verificar todos os detalhes da receita. Clique em  para iniciar e em  para a coleção favorita.

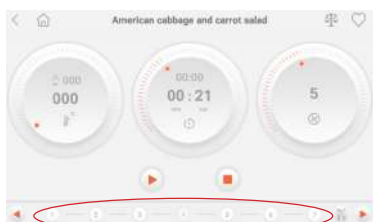
13



A receita possui parâmetros predefinidos. Clique em  para começar. O número no círculo vermelho representa cada etapa de trabalho, clique em  para verificar todos os detalhes da receita.

14

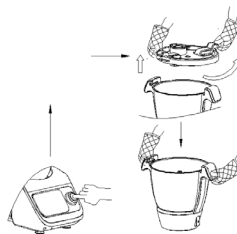

Após o cozimento, a tela exibirá Fim. Pressione o botão rotativo e ele parará de cozinhar. Se você deseja suspender durante o cozimento, pressione o botão rotativo. Em seguida, pressione novamente e o fogão continuará a cozinhar. O fogão irá parar de cozinhar se você pressionar o botão rotativo por muito tempo.

15

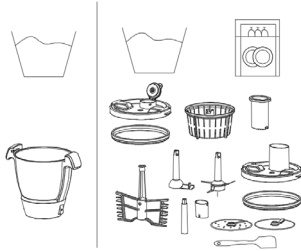

Acessórios que podem ser colocados na máquina de lavar louça.



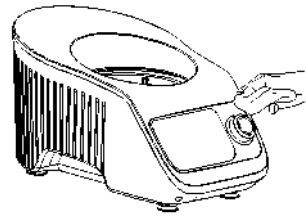









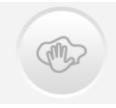









16



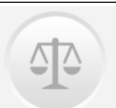







Limpe a unidade principal

6. Visão geral do painel de controle

Número de série	Ícone	Descrição da função
12		(1) Pode ser usado para definir temperatura, tempo, velocidade; ou IU, programa automático, receita. (2) Pressione o botão e o fogão suspenderá o cozimento. Continuará a cozinhar se você pressionar novamente. Ou confirme sua escolha. (3) Pressione e segure o botão para que o fogão pare de cozinhar. (4) Pressione o botão depois de terminar todas as configurações e o cozimento começará a cozinhar. (5) Ele será cancelado automaticamente se você pressionar o botão durante o ajuste. (6) Ao terminar de cozinhar, pressione o botão e a panela entrará no modo de espera.
27.1		Reverter Faixa de velocidade: 1-3
27.2		Velocidade: Clique em para alternar entre sentido horário e ré Faixa de velocidade: 0-12
26		Parâmetro de tempo definido do display: 0-90 minutos Exibição do tempo de operação: 0-90 minutos
25.1		Exibir parâmetro de temperatura definida Faixa de temperatura: 37-120°C Após 37, 40°C, em intervalos de 5°
25.2		Ícone Fechar / Abrir
25.3		Temperatura dos alimentos / ingredientes: Após 37, 40 °C, em intervalos de 5 °
28		: botão de início , : pausa , : parada
30		Botão de configuração: defina ou verifique as informações de cozimento do robô, incluindo: Wifi, versão do sistema, idioma, etc.

31		Botão Página inicial: Página inicial	
32		Botão de peso	
33.1		Amassar: Tempo: 3 (Faixa: 2-4) minutos Temp: 000 (Faixa: 000-37) °C Velocidade: 2 (Faixa: 1-3)	
33.2		Vapor: Tempo: 20 (Faixa: 1-60) minutos Fluxo de vapor: Rápido / Médio / Lento A contagem regressiva do tempo começa a formar 95°C	
33.3		Cozimento lento Tempo: 60 (Faixa: 10-90) minutos Temp: 100 (Faixa: 60-100)°C Velocidade: 1 (Faixa: 1-3)	
33.4		Ferver Temp: 100 (Faixa: 60-100)°C	
33.5		Processador de alimentos Tempo: 30 (Faixa: 10-60) segundos Velocidade: 5 (Faixa: 5-7)	
33.6		Picar Tempo: 10s (Faixa: 10s-4m) Velocidade: 6 (Faixa: 1-12)	
33.7		Turbo Tempo: 60s Velocidade: 12 Pressione  ou Pressione o botão e solte para parar	
33.8		Pesar Max: 5Kgs Intervalo de 5g	
33.8.1		Tara	
33.8.2		Pesagem final	
34		Gestão de classificação	
35		A-Z	
36		Pesquisar	

37		Mais Incluindo coleção e história favoritas
44		Saída
45	 	Favorito / Histórico
46		Ingredientes Picto
47		Passo de cozimento
48		Dicas do chef
49		Acessórios Picto
50		Verifique as informações da receita, incluindo

7. Ajustando a hora

7.1: Intervalo de tempo: 0-90 minutos

7.2: clique em  , clique em min ou seg, deslize ou gire o botão para definir o tempo

8. Ajustando a temperatura

8.1: Faixa de temperatura: 37-120°C, com intervalo 5°C

8.2: Clique em  o picto ou gire o botão para definir a temperatura

9. Ajustando a velocidade

9.1: Faixa de velocidade: 0-12

9.2: Clique em  , deslize o picto ou gire o botão para definir a velocidade

9.3  : Clique em  , mude para  , com a configuração de velocidade 1-3

9.4:  velocidade 1-3:

 velocidade 1-4:

 velocidade 1-12

10. Iniciar, pausar e parar

10.1  Iniciar

10.2  Pausar

10.3  Parar

Durante o modo de espera, as luzes branca e vermelha piscam. A luz vermelha embaixo do botão fica acesa quando a temperatura está acima de 60°C e a luz branca acende quando a temperatura está abaixo de 60°C, em qualquer modo

11. Uso sugerido

Método				
Função	Acessório	Velocidade	Tempo	Ingredientes culinários máximos de uma só vez
Picar carne	Lâmina de corte	Velocidade 8-12	30s-60s	600g Carne de porco sem osso / tendão
Picar gelo	Lâmina de corte	Velocidade 8-12	10-20s	600g de cubo de gelo
Liquidificador	Lâmina de corte	Velocidade 12	1min	Capacidade máxima: 2300ml 920g de cenoura 1380g de água
Cortar (Cebola, chalota, aipo, etc.)	Lâmina de corte	Velocidade 5	15s-30s	500g
Amassar	Lâmina de corte	Velocidade 1	2mins	500g de farinha + 250g de água + 20g de óleo
Fatias, pedaços (Cenoura, pepino, batata)	discos de corte	Velocidade 5-6	30s	500g
Sopa	Reme para mexer	Velocidade 1	Escolha a função Sopa. Ou você pode definir o tempo, velocidade e temperatura adequados por conta própria.	Capacidade Máxima 2000ml

12. Cuidados e limpeza:

12.1. Sempre desligue e desconecte antes de limpar.

12.2. Remova a tampa e a ferramenta da tigela antes de limpar,

12.3. Unidade de potência. Limpe com um pano úmido e depois seque. Nunca use produtos abrasivos ou mergulhe na água.

12.4. Quando houver uma marca de queimadura no fundo do copo, coloque um pouco de ácido cítrico ou limão na água, aqueça por 5 a 7 minutos e remova a marca de queimadura com uma esfregona

12.5. Tigela / remo de agitação / lâmina. Lave as peças e seque bem. Se alimentos ou queimaduras grudarem no interior da tigela, remova o máximo possível usando uma espátula. Encha a tigela com água morna e sabão e deixe de molho. Remova os depósitos mais difíceis usando uma escova de limpeza.



Qualquer descoloração da tigela não afetará seu desempenho.

12.6. Como retirar o cesto de vapor

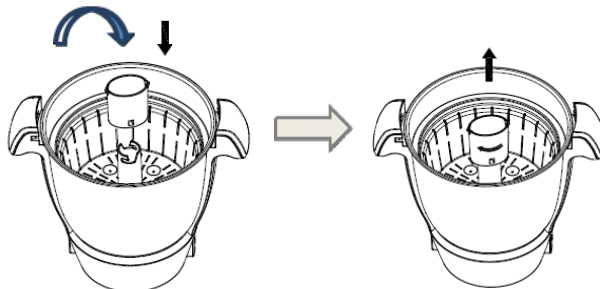
Coloque o copo de medição na ranhura do cesto de vapor e rode para fixar. Então tire.

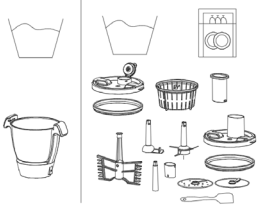

13. Limpeza e Manutenção

Desconecte o cabo de alimentação antes de limpar	Use um pano de prato seco para limpar a unidade principal. Não lave com água ou coloque na máquina de lavar louça.
<p>Tampa, copo medidor, lâmina, pá para misturar, cesto de vapor, vaporizador, etc. Todos os acessórios para fotos acima podem ser lavados na máquina de lavar louça.</p> 	<p>Escova de metal, escova de nylon, limpador doméstico, diluente, produtos de limpeza, etc. danificarão a superfície da estrutura do produto.</p> 
Use um pano seco e macio para limpar o cabo de alimentação.	

14. Especificação do produto

Modelo: SS-14565

Tensão nominal : 220-240V~ 50-60Hz

Potência de aquecimento: 1000W

Potência de mistura: 600W

Capacidade do recipiente: 2.0L/3.5L(Max)

Potência de aquecimento + Potência de mistura: 1300W

15. Redefinir o controle de temperatura



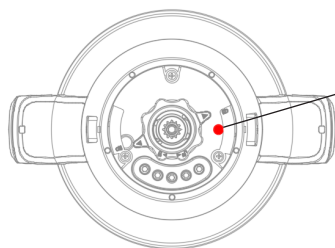

Se a máquina parar de funcionar devido a excesso de temperatura, você pode pressionar o botão de redefinição de temperatura localizado na parte inferior do jarro. Certifique-se de que o jarro esfrie e faça com que funcione novamente.

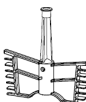
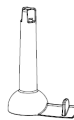
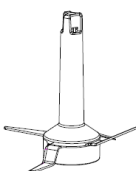

Botão de redefinição de temperatura
Pressione e clique

**VISTA INFERIOR
DO JARRO**

16. Visão geral dos acessórios

Peça chave		Função	Velocidade	Tempo	Temperatura°C
	Espanador	Chicote de clara de ovo	4	2-4 minutos	---
		Chantilly	3	3-5 minutos	---
	Remo de agitação	Sopa	1-2	1-90 minutos	100°C
		Outros ingredientes que precisam ser aquecidos	1-2	Conforme a necessidade	Conforme a necessidade
	Lâmina	Corte de carne	8-12	30-60s	---
		Açúcar de gelo picado	8-12	10-20s	--
		Liquidificador	8-12	1-2 minutos	---
		Cortar (Cebola, chalota, aipo etc)	5-7	15-60s	---
		Feijão, soja, nozes, amendoim, Grão de café, amêndoa	12	2-3 minutos	---
		Amassar	1	1-2 minutos	--
	Cesto de vapor	Arroz, etc.	---	20-30 minutos	100-110°C
	Fatiador / disco de trituração	Fatias	5-6	30-60s	--
	Vaporizador	Peixe...	---	10-60 minutos	110-120°C

Diese Bedienungsanleitung kann auch von unserer Webseite www.sogo.es

Bitte lesen Sie diese Anweisungen sorgfältig durch, bevor Sie das Produkt verwenden

1. Lesen Sie diese Anweisungen sorgfältig durch und bewahren Sie sie zum späteren Nachschlagen auf.
2. Schalten Sie das Gerät aus und trennen Sie es von der Stromversorgung, bevor Sie Zubehör wechseln oder sich Teilen nähern, die sich während des Gebrauchs bewegen.
3. Halten Sie Körperteile, Schmuck und lose Kleidung von beweglichen Teilen und montierten Werkzeugen / Aufsätzen fern.
4. Entfernen Sie immer die Klinge, bevor Sie den Inhalt aus der Schüssel gießen.
5. Halten Sie die Hände und Utensilien von der Schüssel fern, während Sie sie an die Stromversorgung anschließen.
6. Verwenden Sie niemals ein beschädigtes Gerät. Lassen Sie es überprüfen oder reparieren.
7. Überschreiten Sie nicht den auf der Innenseite der Schüssel angegebenen maximalen Füllstand.
8. Lassen Sie das Netzteil, das Kabel oder den Stecker niemals nass werden.
9. Seien Sie vorsichtig, wenn Sie einen Teil des Geräts handhaben oder berühren, wenn es im Kochmodus oder nach dem Kochen verwendet wird. Insbesondere die Schüssel, der Deckel und die Werkzeuge, da diese auch nach dem Ausschalten des Geräts noch HEISS bleiben.
10. Entfernen und tragen Sie die Schüssel mit den Griffen. Verwenden Sie beim Umgang mit der heißen Schüssel und den heißen Werkzeugen Ofenhandschuhe.

11. Die Unterseite der Schüssel bleibt lange nach dem Aufheizen heiß. Seien Sie vorsichtig beim Umgang mit und bei der Verwendung einer Arbeitsflächenschutzmatte, wenn Sie die Schüssel auf wärmeempfindliche Oberflächen stellen.
12. Achten Sie darauf, dass kein Dampf aus der Schüssel austritt, insbesondere wenn Sie den Deckel oder den Einfülldeckel entfernen.
13. Entfernen Sie nicht den Deckel oder den Einfülldeckel, während die Flüssigkeit kocht.
14. Schließen Sie immer den Einfülldeckel, wenn Sie die Hackfunktion verwenden.
15. Verwenden Sie nur die Schüssel und Werkzeuge mit diesem Gerät geliefert. Verwenden Sie die Schüssel niemals mit einer anderen Wärmequelle.
16. Betreiben Sie das Gerät niemals im Kochmodus mit leerer Schüssel.
17. Verwenden Sie den Mixerdeckel nicht zur Bedienung des Prozessors. Dieses Gerät wird beschädigt und kann Verletzungen verursachen, wenn der Verriegelungsmechanismus übermäßiger Kraft ausgesetzt wird.
18. Wenn Sie dieses Gerät verwenden, stellen Sie sicher, dass es auf einer ebenen Fläche vom Rand entfernt positioniert ist. Nicht unter überhängenden Schränken positionieren.
19. Stellen Sie für einen korrekten und sicheren Betrieb sicher, dass der Schüsselboden und die Temperatursensoren vor dem Kochen sauber und trocken sind.
20. **VORSICHT: Um eine Gefahr durch versehentliches Zurücksetzen der thermischen Abschaltung zu vermeiden, darf dieses Gerät nicht über ein externes Schaltgerät wie einen Timer versorgt oder an**

einen Stromkreis angeschlossen werden, der regelmäßig ein- und ausgeschaltet wird.

21. Stellen Sie immer sicher, dass das Essen gründlich gekocht und heiß ist, bevor Sie es essen.
22. Lebensmittel sollten kurz nach dem Kochen gegessen oder schnell abgekühlt und dann so schnell wie möglich gekühlt werden.
23. Der Missbrauch Ihres Geräts kann zu Verletzungen führen.
24. Geräte können von Personen mit eingeschränkten körperlichen, sensorischen oder geistigen Fähigkeiten oder mangelnder Erfahrung und Kenntnissen verwendet werden, wenn sie auf sichere Weise beaufsichtigt oder unterwiesen wurden und die damit verbundenen Gefahren verstehen.
25. Kinder dürfen nicht mit dem Gerät spielen.
26. Dieses Gerät darf nicht von Kindern benutzt werden. Bewahren Sie das Gerät und sein Kabel außerhalb der Reichweite von Kindern auf. Lassen Sie das Kabel niemals herunterhängen, wo ein Kind es greifen könnte.
- 27. Warnung: Seien Sie vorsichtig beim Umgang mit den scharfen Schneidklingen, beim Entleeren der Schüssel und beim Reinigen.**
28. Trennen Sie das Gerät immer von der Stromversorgung, wenn es unbeaufsichtigt bleibt und vor der Montage, Demontage oder Reinigung.
29. Wenn das Versorgungskabel beschädigt ist, muss es durch eine spezielle Kabelbaugruppe ersetzt werden, die vom Hersteller oder seinem Servicemitarbeiter erhältlich ist, um eine Gefahr zu vermeiden.
30. Verwenden Sie das Gerät nur für den bestimmungsgemäßen Gebrauch im Haushalt. Wir

übernehmen keine Haftung, wenn das Gerät unsachgemäß verwendet oder diese Anweisungen nicht eingehalten werden.

31. Die maximale Beladung für die Mischfunktion beträgt 920 g Karotten / 1380 g Wasser
32. Seien Sie vorsichtig, wenn heiße Flüssigkeit in die Küchenmaschine oder den Mixer gegossen wird, da diese aufgrund eines plötzlichen Dampfens aus dem Gerät ausgestoßen werden kann.
33. Das Gerät darf nur mit dem mitgelieferten Ständer verwendet werden.
34. Das Gerät ist nur für den Hausgebrauch und den Innenbereich bestimmt.
35. Verschütten Sie den Stecker nicht.
36. Zerlegen Sie den Boden des Bechers (einschließlich des Griffgehäuses) nicht, er dient nicht der Wartung durch den Benutzer.
37. Nachdem der Motor nicht mehr funktioniert (falls vorhanden), arbeitet der Lüfter noch weitere 2 Minuten
- 38. Oberflächen können während des Gebrauchs heiß werden.**
39. Informationen zum Reinigen der Oberflächen, die mit Lebensmitteln in Kontakt kommen, finden Sie im Abschnitt Pflege und Reinigung.
- 40. VORSICHT: Stellen Sie sicher, dass das Gerät ausgeschaltet ist, bevor Sie es vom Ständer nehmen.**



Vor dem Einstecken

Stellen Sie sicher, dass Ihre Stromversorgung mit der auf der Unterseite Ihres Geräts angegebenen übereinstimmt.

WARNUNG: DIESES GERÄT MUSS ERDET WERDEN.

1. Produktübersicht

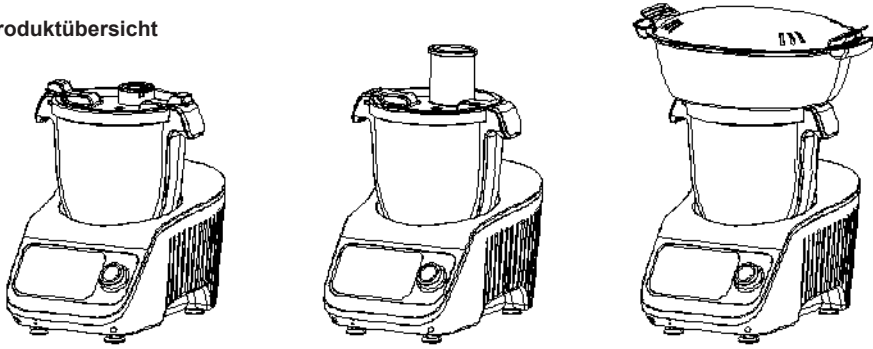

2. Teile

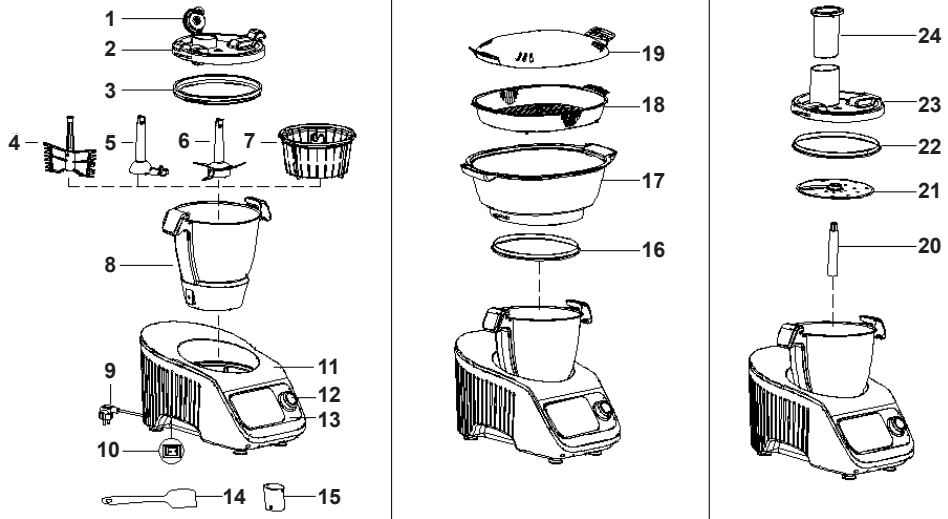

3. Display-Bildschirm

1) DIY Benutzeroberfläche

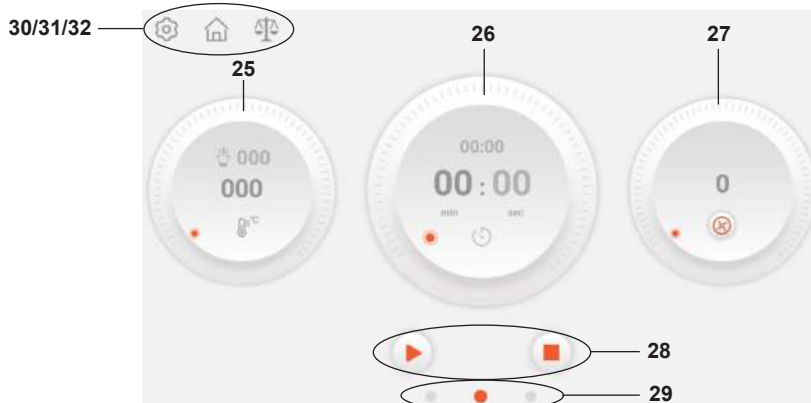

2) Benutzeroberfläche für automatische Programme

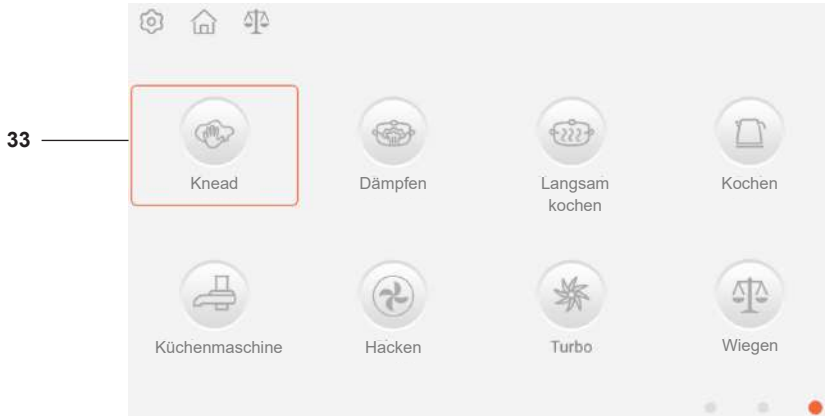

3) Rezept UI

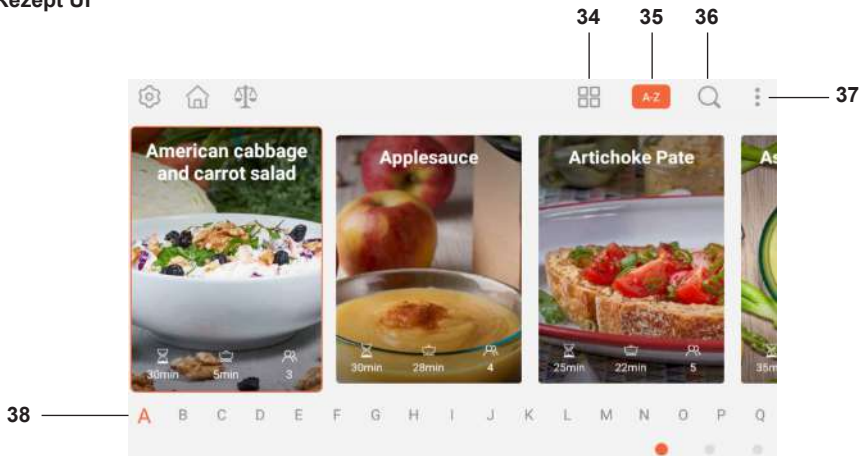

4) Einrichtung UI

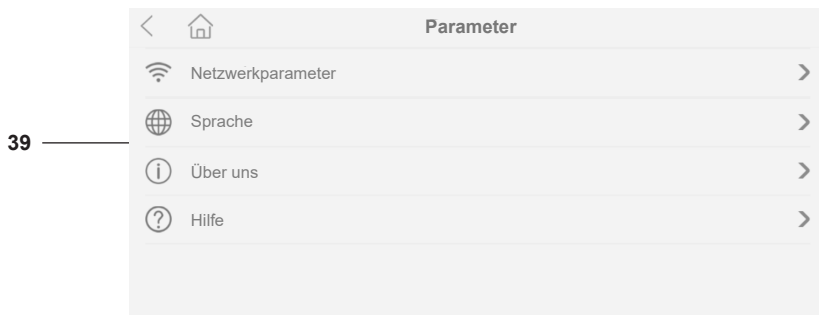

5) Heim UI



4. Schlüsselteile

No.	Name	No.	Name	No.	Name
1	Einfüllverschluss	16	Siegel des tiefen Dampfkorbs	31	Home-Taste
2	Mixerdeckel	17	Dampfkorb, tief	32	Gewichtstaste
3	Mixerdeckeldichtung	18	Dampfkorb, flach	33	Funktionstaste
4	Schneebesen	19	Deckel für Dampfkorb	34	Sortieren managment
5	Rührpaddel	20	Antriebswelle	35	A-Z
6	Klinge	21/21A	Slicer/Fetzen	36	Suchtaste
7	Dampfkorb	22	Dichtung für FP-Deckel	37	Taste Mehr
8	Mixbecher	23	FP Deckel	38	A-Z Taste
9	Netzkabel	24	Drücker	39	Benutzeroberfläche einrichten
10	Hauptschalter	25	Temperaturknopf	40	Rezepte Benutzeroberfläche
11	Basiseinheit	26	Timer-Taste	41	DIY Benutzeroberfläche
12	Knopf	27	Geschwindigkeitstaste	42	Auto program Benutzeroberfläche
13	Anzeigebildschirm	28	Start / Pause / Stop-Taste	43	Download Benutzeroberfläche
14	Spatel	29	Interface Schaltpunkt		
15	Messbecher	30	Setup-Taste		

5. Vor Gebrauch einrichten

1

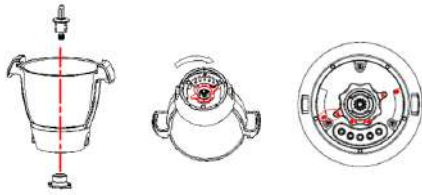

Setzen Sie die Antriebswelle richtig in den Krug ein.

2



Setzen Sie den Krug in das Hauptgerät ein. Drücken Sie fest nach unten, um einrasten zu können. (LOGO vorne, Max hinten)

3

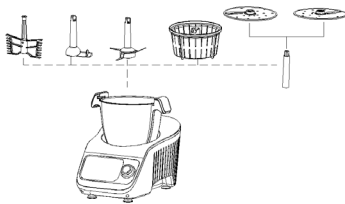

Wählen Sie verschiedene Zubehörteile für unterschiedliche Kochzwecke.

4

Zutaten oder Wasser in den Krug geben. Wenn Sie die Küchenmaschinenfunktion benötigen, bringen Sie den Deckel der Küchenmaschine an und geben Sie die Zutaten direkt durch den Lebensmittelspender.

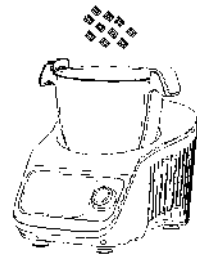

5



Bringen Sie den Mischdeckel, den FP-Deckel oder den Dampfgarer an

6

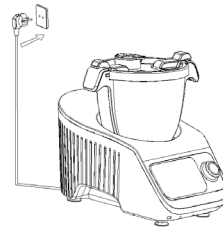

Stecken Sie das Netzkabel in die Hauptbasis und schalten Sie es ein. Wenn die Hauptbasis das Netzkabel hat, montieren Sie das Netzkabel nicht.



7





Schieben Sie das entsprechende Symbol oder drehen Sie den Knopf, um Temperatur, Zeit und Geschwindigkeit einzustellen. Klicken Sie auf die Minute oder Sekunde im Zeitsymbol, um schnell die genaue Zeit einzustellen. Umkehrfunktion: Klicken Sie auf das Symbol , um die Drehrichtung zu ändern

8



Klicken Sie auf , nachdem Sie die Temperatur, die Zeit und die Geschwindigkeit für den Start eingestellt haben. Das Symbol  ändert sich dann in . Die Maschine arbeitet jetzt.

Klicken oder drücken Sie die -Taste im Knopf, um die Arbeit zu unterbrechen, klicken Sie auf  oder drücken Sie kontinuierlich die Taste im Knopf, um die Arbeit zu beenden und das Programm zu beenden.

9



Wenn Sie auf dem Bildschirm nach rechts schieben oder auf den rechten Punkt im roten Kreis klicken oder den Knopf im Uhrzeigersinn drehen, gelangen Sie zum allgemeinen Funktionsmenü. Klicken Sie auf oder auf den mittleren Punkt im roten Kreis, um zum ersten Schritt zum Zurücksetzen zurückzukehren.

10



Klicken Sie im allgemeinen Funktionsmenü auf das Funktionssymbol, um zur entsprechenden Bildschirmoberfläche zu gelangen. Beginnen Sie mit der Arbeit, nachdem Sie die Schritte 7 und 8 ausgeführt haben. Klicken Sie hier um diese Schnittstelle zu beenden. Dieses Symbol dient zum Dämpfen.

11

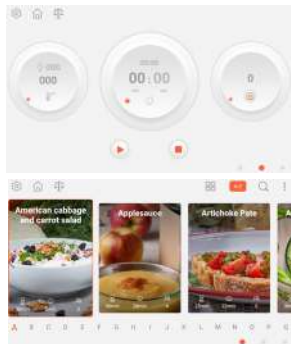

Wenn Sie auf dem Bildschirm nach links schieben oder auf den linken Punkt im roten Kreis klicken oder den Knopf gegen den Uhrzeigersinn drehen, gelangen Sie zum Rezeptmenü. Klicken Sie auf oder auf den mittleren Punkt im roten Kreis, um zum ersten Schritt zum Zurücksetzen zurückzukehren.

12



Klicken Sie auf das Rezeptfoto, rufen Sie die Rezeptoberfläche auf und klicken Sie auf

um alle Rezeptdetails zu überprüfen. Klicken Sie zum Starten auf und beim Favoriten auf .

13



Das Rezept hat voreingestellte Parameter. Klicken Sie zum Starten auf . Die Zahl im roten Kreis steht für jeden Arbeitsschritt. Klicken Sie auf , um alle Rezeptdetails zu überprüfen.

14

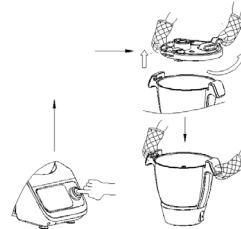

Nach dem Kochen wird auf dem Bildschirm Ende angezeigt. Drücken Sie den Drehknopf und der Garvorgang wird beendet. Wenn Sie während des Kochens anhalten möchten, drücken Sie den Drehknopf. Drücken Sie dann erneut und der Herd kocht weiter. Der Herd hört auf zu kochen, wenn Sie den Drehknopf lange drücken.

15

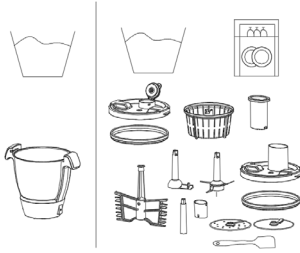





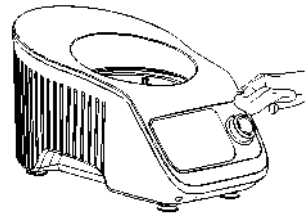







Zubehör, das in die Spülmaschine gestellt





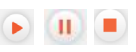







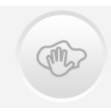





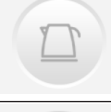

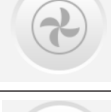

16

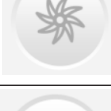

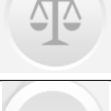







Reinigen Sie das Hauptgerät

6. Übersicht über die Systemsteuerung

Ordnungsnummer	Ikone	Bedienungsanleitung
12		(1) Kann zum Einstellen von Temperatur, Zeit und Geschwindigkeit verwendet werden. oder UI, Auto-Programm, Rezept. (2) Drücken Sie den Knopf und der Herd unterbricht das Garen. Wenn Sie erneut drücken, wird das Garen fortgesetzt. Oder bestätigen Sie Ihre Wahl. (3) Wenn Sie den Knopf lange drücken, hört der Herd auf zu kochen. (4) Drücken Sie den Knopf, nachdem Sie alle Einstellungen vorgenommen haben, und der Garvorgang beginnt. (5) Es wird automatisch abgebrochen, wenn Sie den Knopf während der Einstellung lange drücken. (6) Wenn Sie mit dem Garen fertig sind, drücken Sie den Knopf und der Herd wechselt in den Standby-Modus.
27.1		Umkehren Geschwindigkeitsbereich: 1-3
27.2		Geschwindigkeit: Klicken Sie auf  , um zwischen Uhrzeigersinn und Rückwärts zu wechseln Geschwindigkeitsbereich: 0-12
26		Parameter für die eingestellte Zeit anzeigen: 0-90 Minuten Betriebszeitanzeige: 0-90 Minuten
25.1		Den eingestellten Temperaturparameter anzeigen Temperaturbereich: 37-120°C Nach 37, 40° C in Abständen von 5 °
25.2		Schließen / Öffnen-Symbol
25.3		Temperatur der Lebensmittel / Zutaten: Nach 37, 40°C in Intervallen von 5 °
28		 : Start,  : Pause,  : Stop-Taste
30		Setup-Taste: Stellen Sie die Informationen zum Roboterkoch ein oder überprüfen Sie sie, einschließlich: WLAN, Systemversion, Sprache usw.

31		Home-Taste: Startseite	
32		Gewichtstaste	
33.1		Kneten: Zeit: 3 (Bereich: 2-4) Minuten Temp: 000 (Bereich: 000-37) °C Geschwindigkeit: 2 (Reichweite: 1-3)	
33.2		Dampf: Zeit: 20 (Bereich: 1-60) Minuten Dampfstrom: Schnell / Mittel / Langsam Der Countdown beginnt bei 95°C.	
33.3		Langsam kochen Zeit: 60 (Bereich: 10-90) Minuten Temp: 100 (Bereich: 60-100) °C Geschwindigkeit: 1 (Bereich: 1-3)	
33.4		Kochen Temp: 100 (Bereich: 60-100) °C	
33.5		Küchenmaschine Zeit: 30 (Bereich: 10-60) Sekunden Geschwindigkeit: 5 (Reichweite: 5-7)	
33.6		Hacken Zeit: 10s (Reichweite: 10s-4m) Geschwindigkeit: 6 (Bereich: 1-12)	
33.7		Turbo Zeit: 60er Jahre Geschwindigkeit: 12 Drücken Sie  oder Drücken Sie den Knopf und lassen Sie ihn los, um anzuhalten	
33.8		Wiegen Max: 5 kg 5g Intervall	
33.8.1		Tara	
33.8.2		Ende des Wiegens	
34		Sortierverwaltung	
35		A-Z	
36		Suchen	

37		Mehr Einschließlich Lieblingsammlung und Geschichte
44		Verlassen
45		Lieblings / Geschichte
46		Zutaten Picto
47		Kochschritt
48		Tipps des Küchenchefs
49		Zubehör Picto
50		Überprüfen Sie die Rezeptinformationen einschließlich

7. Uhrzeit einstellen

7.1: Zeitbereich: 0-90 Minuten

7.2: Klicken Sie auf  , klicken Sie auf min oder sec, schieben oder drehen Sie den Knopf, um die Zeit einzustellen

8. Temperatur einstellen



8.1: Temperaturbereich: 37-120°C, mit einem Intervall von 5°C

8.2: Klicken Sie auf  schieben Sie das Bild oder drehen Sie den Knopf, um die Temperatur einzustellen

9. Geschwindigkeit einstellen

9.1: Geschwindigkeitsbereich: 0-12

9.2: Klicken Sie auf  , schieben Sie das Bild oder drehen Sie den Knopf, um die Geschwindigkeit einzustellen

9.3  : Klicken Sie auf  wechseln Sie mit der Geschwindigkeitseinstellung 1-3 zu 

9.4:  Geschwindigkeit 1-3:

 Geschwindigkeit 1-4:

 Geschwindigkeit 1-12

10. Start, Pause und Stopp

10.1  Start

10.2  Pause

10.3  Stopp

Im Standby-Modus blinken weiße und rote Lichter. Das rote Licht unter dem Knopf leuchtet, wenn die Temperatur über 60°C liegt, und das weiße Licht leuchtet, wenn die Temperatur unter 60°C liegt, in jedem Modus

11. Empfohlene Verwendung

Methode				
Funktion	Zubehörteil	Geschwindigkeit	Zeit	Maximale Kochzutaten auf einmal
Fleisch hacken	Klinge zum Hacken	Geschwindigkeit 8-12	30s-60s	600g Rind- / Schweinefleisch ohne Knochen / Sehne
Eis zerquetschen	Klinge zum Hacken	Geschwindigkeit 8-12	10-20s	600 g Eiswürfel
Mixer	Klinge zum Hacken	Geschwindigkeit 12	1min	Maximale Kapazität: 2300ml 920 g Karotte 1380 g Wasser
Hacken (Zwiebel, Schalotte, Sellerie usw.)	Klinge zum Hacken	Geschwindigkeit d 5	15s-30s	500g
Kneten	Klinge zum Hacken	Geschwindigkeit 1	2mins	500 g Mehl + 250 g Wasser + 20 g Öl
Scheiben, Fetzen (Karotte, Gurke, Kartoffel)	Scheiben zum Schneiden	Geschwindigkeit 5-6	30s	500g
Suppe	Paddle zu rühren	Geschwindigkeit 1	Wählen Sie die Suppenfunktion. Oder Sie können die richtige Zeit, Geschwindigkeit und Temperatur selbst einstellen	Maximale Kapazität 2000ml

12. Pflege und Reinigung:

12.1. Vor dem Reinigen immer ausschalten und den Netzstecker ziehen.

12.2. Entfernen Sie vor dem Reinigen den Deckel und das Werkzeug von der Schüssel.

12.3. Netzteil. Mit einem feuchten Tuch abwischen und trocknen. Verwenden Sie niemals Schleifmittel und tauchen Sie niemals in Wasser.

12.4. Wenn sich am Boden des Mixbechers Brandflecken befinden, etwas Zitronensäure oder Zitronen in Wasser geben, 5 bis 7 Minuten erhitzen und dann die Brandflecken mit einem Mopp entfernen

12.5. Schüssel / Rührpaddel / Klinge. Waschen Sie die Teile und trocknen Sie sie gründlich ab. Wenn sich



an der Innenseite der Schüssel Lebensmittel oder Verbrennungen festsetzen, entfernen Sie so viel wie möglich mit einem Spatel. Füllen Sie die Schüssel mit warmem Seifenwasser und lassen Sie sie einweichen. Hartnäckige Ablagerungen mit einer Reinigungsbürste entfernen. Verfärbungen der Schüssel beeinträchtigen die Leistung nicht.

12.6. Herausnehmen des Dampfkorb

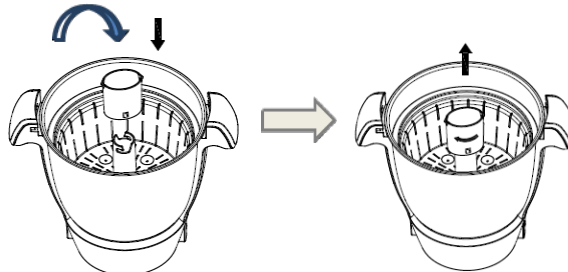
Setzen Sie den Messbecher in den Dampfkorbsschlitz und drehen Sie ihn zum Fixieren. Dann nehmen Sie es heraus.

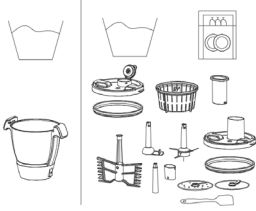

13. Reinigung und Wartung

Bitte ziehen Sie vor der Reinigung das Netzkabel ab	Bitte verwenden Sie eine trockene Geschirrtuch, um das Hauptgerät zu reinigen. Nicht mit Wasser waschen oder in die Spülmaschine geben
<p>Deckel, Messbecher, Klinge, Mischpaddel, Dampfkorb, Dampfgarer usw. Alle Zubehörteile auf dem obigen Bild können mit einer Geschirrspülmaschine gewaschen werden.</p> 	<p>Metallbürste, Nylonbürste, Haushaltsreiniger, Verdünnungsmittel, Reinigungsmittel usw. beschädigen die Oberfläche der Produktstruktur</p> 
Bitte reinigen Sie das Netzkabel mit einem trockenen und weichen Tuch.	

14. Produktspezifikation

Modell: SS-14565

Nennspannung: 220-240V, 50-60Hz

Heizleistung: 1000W

Mischleistung: 600W

Schüsselkapazität : 2.0L/3.5L(Max)

Heizleistung + Mischleistung: 1300W

15. Temperaturregelung zurücksetzen



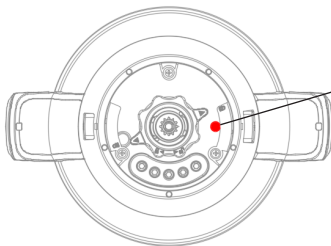

Wenn die Maschine aufgrund von Übertemperatur nicht mehr funktioniert, können Sie die Taste zum Zurücksetzen der Temperatur unten am Krug drücken. Stellen Sie sicher, dass der Krug abkühlt und dann wieder funktioniert.

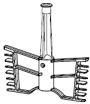

**KRUG UNTEN
ANSICHT**

Temperatur-Reset-Taste
Drücken Sie darauf und
klicken Sie auf

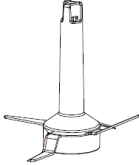
16. Zubehörübersicht

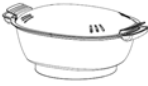
Schlüsselteil	Funktion	Geschwindigkeit	Zeit	Temperatur°C	
	Schneebesen	Eiweiß schlagen	4	2-4 minuten	---
		Schlagsahne	3	3-5 minuten	---
	Paddel zum Rühren	Suppe	1-2	1-90 minuten	100°C
		Andere Zutaten, die erhitzt werden müssen	1-2	Nach Bedarf	Nach Bedarf
	Klinge	Fleisch hacken	8-12	30-60s	---
		Eis zerquetschen Zucker	8-12	10-20s	--
		Mixer	8-12	1-2 minuten	---
		Hacken (Zwiebel, Schalotte, Sellerie usw.)	5-7	15-60s	---
		Bohne, Sojabohne, Nuss, Erdnuss, Kaffeebohne, Mandel	12	2-3 minuten	---
		Kneten	1	1-2 minuten	--
	Dampfkorb	Reis etc.	---	20-30 minuten	100-110°C
	Schneider/ Fetzen Sheibe	Scheiben	5-6	30-60s	--
	Dampfer	Fisch...	---	10-60 minuten	110-120°C

Questo manuale di istruzioni può anche essere scaricato dalla nostra pagina web www.sogo.es

Leggere attentamente queste istruzioni prima di utilizzare il prodotto

1. Leggere attentamente queste istruzioni e conservarle per riferimenti futuri.
2. Spegnerne l'apparecchio e scollegarlo dall'alimentazione prima di cambiare gli accessori o avvicinarsi alle parti che si muovono durante l'uso.
3. Tenere le parti del corpo, i gioielli e gli indumenti larghi lontani dalle parti in movimento e dagli strumenti / accessori montati.
4. Rimuovere sempre la lama prima di versare il contenuto dal contenitore.
5. Tenere le mani e gli utensili fuori dalla ciotola mentre sono collegati all'alimentazione.
6. Non utilizzare mai un apparecchio danneggiato. Fallo controllare o riparare.
7. Non superare il livello massimo di riempimento indicato all'interno della tazza.
8. Non lasciare mai bagnare l'alimentatore, il cavo o la spina.
9. Prestare attenzione quando si maneggia o si tocca qualsiasi parte dell'apparecchio quando viene utilizzato in modalità di cottura o dopo la cottura. In particolare la ciotola, il coperchio e gli strumenti, poiché rimarranno CALDI per molto tempo dopo che l'apparecchio è stato spento.
10. Utilizzare le maniglie per rimuovere e trasportare la ciotola. Usare guanti da forno quando si maneggiano la ciotola calda e gli strumenti caldi.

11. La parte inferiore della tazza rimarrà calda per molto tempo dopo l'interruzione del riscaldamento. Prestare attenzione quando si maneggia e utilizzare un tappetino di protezione della superficie di lavoro quando si posiziona la ciotola su superfici sensibili al calore.
12. Prestare attenzione alla fuoriuscita di vapore dalla bacinella, in particolare quando si rimuove il coperchio o il tappo di riempimento.
13. Non rimuovere il coperchio o il tappo di riempimento mentre il liquido bolle.
14. Chiudere sempre il tappo di riempimento quando si utilizza la funzione di taglio.
15. Utilizzare solo la tazza e gli strumenti forniti con questo apparecchio. Non usare mai la ciotola con altre fonti di calore.
16. Non utilizzare mai l'apparecchio in modalità cottura con la ciotola vuota.
17. Non utilizzare il coperchio del frullatore per azionare il processore. Questo apparecchio verrà danneggiato e potrebbe causare lesioni se il meccanismo di interblocco è sottoposto a una forza eccessiva.
18. Quando si utilizza questo apparecchio, assicurarsi che sia posizionato su una superficie piana, lontano dal bordo. Non posizionare sotto armadi a strapiombo.
19. Per un funzionamento corretto e sicuro, assicurarsi che la base della tazza e i sensori di temperatura siano puliti e asciutti prima della cottura.
- 20. ATTENZIONE: al fine di evitare un pericolo dovuto al ripristino involontario del disgiuntore termico, questo apparecchio non deve essere alimentato tramite un**

dispositivo di commutazione esterno, come un timer, o collegato a un circuito regolarmente acceso e spento dall'utilità.

21. Assicurati sempre che il cibo sia ben cotto e sia ben caldo prima di mangiare.
22. Il cibo dovrebbe essere consumato poco dopo la cottura o lasciato raffreddare rapidamente e quindi refrigerato il prima possibile.
23. L'uso improprio dell'apparecchio può provocare lesioni.
24. Gli apparecchi possono essere utilizzati da persone con ridotte capacità fisiche, sensoriali o mentali o mancanza di esperienza e conoscenza se sono stati sottoposti a supervisione o istruzione sull'uso dell'apparecchio in modo sicuro e se comprendono i pericoli coinvolti.
25. I bambini non devono giocare con l'apparecchio.
26. Questo apparecchio non deve essere utilizzato da bambini. Tenere l'apparecchio e il suo cavo fuori dalla portata dei bambini. Non lasciare mai che il cavo penda dove un bambino potrebbe afferrarlo.
27. **Avvertenza: fare attenzione quando si maneggiano le lame affilate, si svuota il contenitore e durante la pulizia.**
28. Scollegare sempre l'apparecchiatura dalla rete elettrica se lasciata incustodita e prima del montaggio, dello smontaggio o della pulizia.
29. Se il cavo di alimentazione è danneggiato, deve essere sostituito con uno speciale gruppo di cavi disponibile dal produttore o dal suo agente di servizio per evitare pericoli
30. Utilizzare l'apparecchio esclusivamente per

l'uso domestico previsto. Non ci assumiamo alcuna responsabilità se l'apparecchio è soggetto a un uso improprio o al mancato rispetto di queste istruzioni.

31. Il carico massimo per la funzione di miscelazione è di 920 g di carote / 1380 g di acqua
32. Prestare attenzione se viene versato liquido caldo nel robot da cucina o nel frullatore poiché può essere espulso dall'apparecchio a causa di un vapore improvviso.
33. L'apparecchio deve essere utilizzato solo con il supporto fornito.
34. L'apparecchio è esclusivamente per uso domestico e interno.
35. Evitare la fuoriuscita del connettore.
36. Non smontare la base della tazza (incluso il contenitore della maniglia), non è per la manutenzione dell'utente.
37. Dopo che il motore ha smesso di funzionare, la ventola di raffreddamento continuerà a funzionare per altri 2 minuti
38. **Le superfici possono surriscaldarsi durante l'uso.** 
39. Per informazioni su come pulire le superfici a contatto con gli alimenti, consultare il paragrafo Cura e pulizia.
40. **ATTENZIONE: assicurarsi che l'apparecchio sia spento prima di rimuoverlo dal supporto. Prima di collegarlo Assicurarsi che la fornitura di energia elettrica sia la stessa mostrata nella parte inferiore dell'apparecchio. ATTENZIONE: QUESTO APPARECCHIO DEVE ESSERE MESSO A TERRA.**

1. Panoramica del prodotto

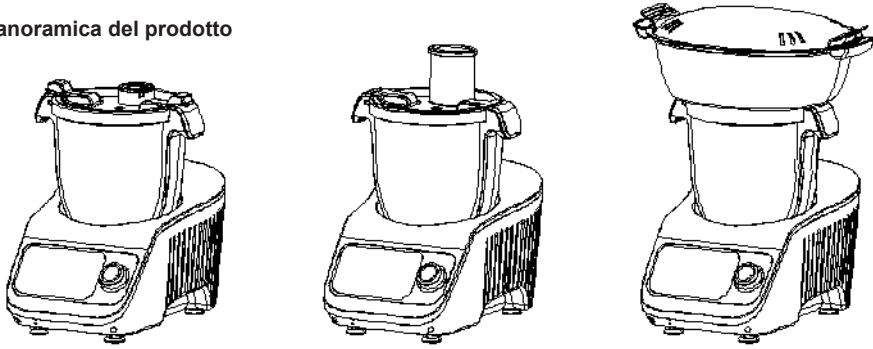

2. Parti

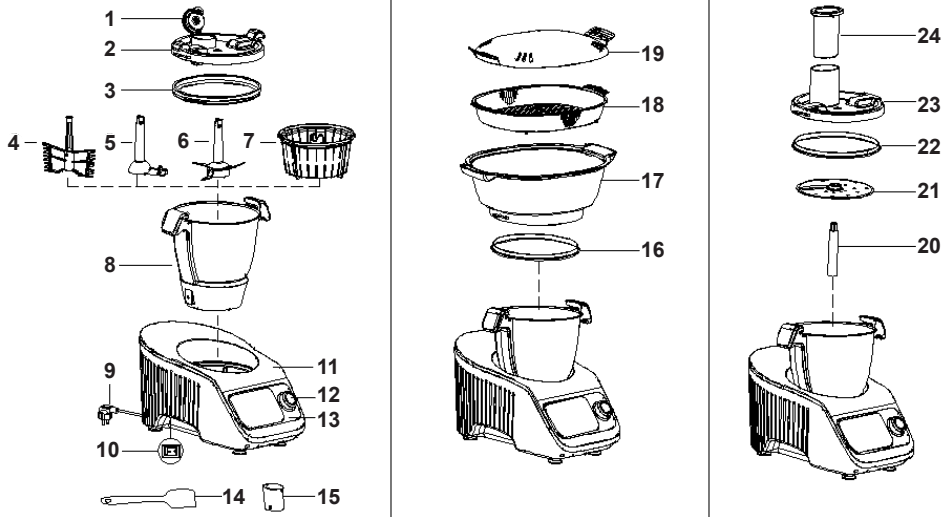

3. Schermo di visualizzazione

1) IU fai da te

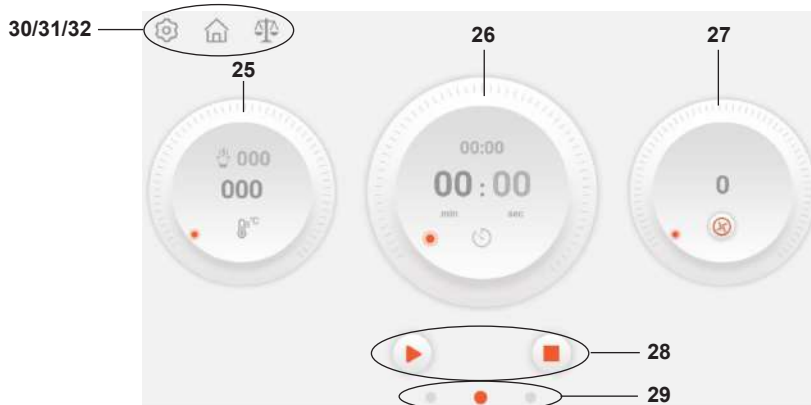

2) IU dei programmi automatici



3) UI Ricetta

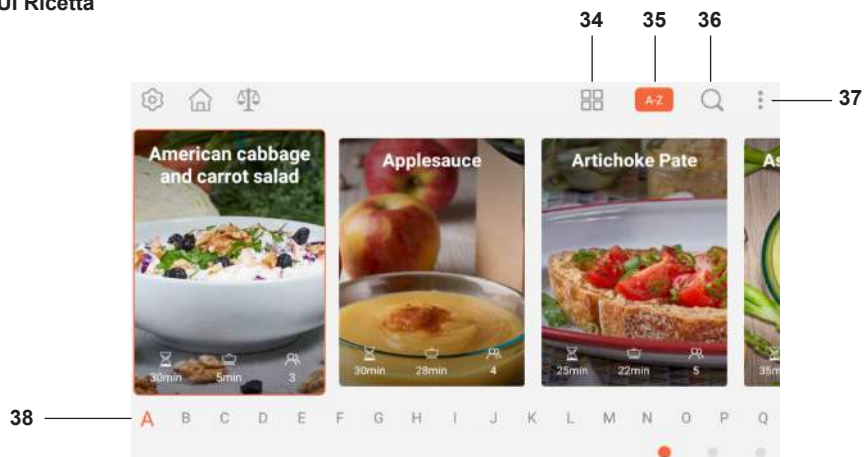

4) Configurazione UI









5) IU domestica

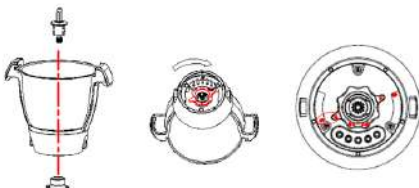

4. Parti chiave

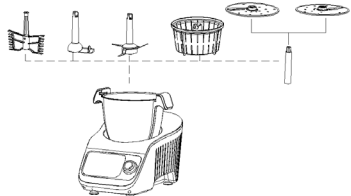
No.	Nome	No.	Nome	No.	Nome
1	Tappo di riempimento	16	Sigillo del cestello per cottura a vapore profondo	31	Pulsante Home
2	Coperchio del frullatore	17	Cestello per cottura a vapore, profondo	32	Pulsante peso
3	Guarnizione del coperchio del frullatore	18	Cestello per cottura a vapore, poco profondo	33	Pulsante funzione
4	Frusta	19	Coperchio per cestello per cottura a vapore	34	Ordina gestione
5	Pagaia per agitazione	20	Albero di trasmissione	35	A-Z
6	Lama	21/21A	Affettatrice / brandello	36	Pulsante di ricerca
7	Cesto a vapore	22	Guarnizione per coperchio FP	37	Pulsante altro
8	Brocca miscelatore	23	Coperchio FP	38	Pulsante A-Z
9	Cavo di alimentazione	24	Spingitore	39	Configurazione IU
10	Interruttore principale	25	Pulsante di temperatura	40	Ricette IU
11	Unità base	26	Pulsante timer	41	Fai da te IU
12	Manopola	27	Pulsante di velocità	42	Programma automatico IU
13	Schermo di visualizzazione	28	Pulsante Start / Pause / Stop	43	Scarica IU
14	Spatola	29	Punto di spostamento dell'interfaccia		
15	Misurino	30	Pulsante di configurazione		

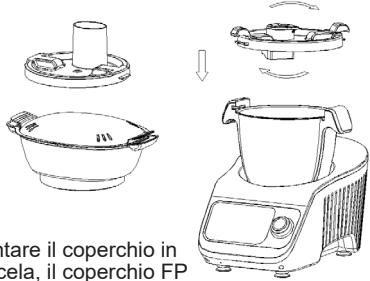
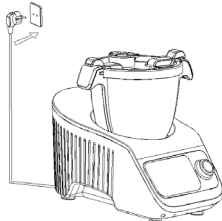
5. Da installare prima dell'uso

<p>1</p>  <p>Posizionare l'albero di trasmissione correttamente bloccato nella caraffa.</p>	<p>2</p>  <p>Inserire la brocca nell'unità principale. Premere con decisione verso il basso per bloccarlo in posizione. (LOGO davanti, Max dietro)</p>
<p>3</p>  <p>Scegli diversi accessori per diversi scopi di cottura.</p>	<p>4</p>  <p>Aggiungi ingredienti o acqua alla caraffa. Se è necessaria la funzione robot da cucina, quindi collegare il coperchio del robot da cucina e inserire gli ingredienti direttamente nel distributore di alimenti.</p>
<p>5</p>  <p>Montare il coperchio in miscela, il coperchio FP o il piroscavo</p>	<p>6</p>  <p>Inserire il cavo di alimentazione nella base principale, quindi accendere. Quando la base principale ha il cavo di alimentazione, non assemblare il cavo di alimentazione</p>
<p>7</p>  <p>Fai scorrere l'icona corrispondente o ruota la manopola per impostare la temperatura, il tempo e la velocità. Fare clic sul minuto o sul secondo nell'icona dell'ora per impostare rapidamente l'ora esatta. Funzione inversa: fare clic sull'icona ▶ per cambiare la direzione di rotazione</p>	<p>8</p>  <p>Fare clic su ▶ dopo aver impostato la temperatura, il tempo e la velocità per iniziare, quindi l'icona cambierà in , la macchina funziona ora.</p> <p>Fare clic o premere il pulsante nella manopola per interrompere il lavoro, fare clic su ■ o premere continuamente il pulsante nella manopola per interrompere il lavoro ed uscire dal programma.</p>

9



Scorrendo verso destra sullo schermo o facendo clic sul punto destro nel cerchio rosso o ruotando la manopola in senso orario, si accederà al menu delle funzioni comuni. Fai clic su o fai clic sul punto centrale nel cerchio rosso per tornare al passaggio iniziale per il ripristino.

10



Fare clic sull'icona della funzione nel menu delle funzioni comuni per accedere all'interfaccia dello schermo corrispondente. Iniziare a lavorare dopo aver completato i passaggi 7 e 8. Fare clic per uscire da questa interfaccia. Questa icona è per la cottura a vapore.

11

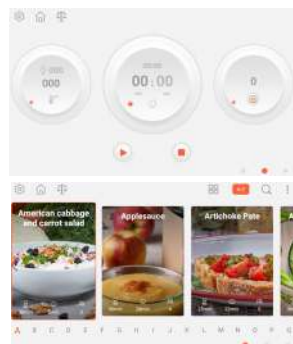

Facendo scorrere lo schermo a sinistra o facendo clic sul punto sinistro nel cerchio rosso o ruotando la manopola in senso antiorario, si accede al menu delle ricette. Fai clic sulla o fai clic sul punto centrale nel cerchio rosso per tornare al passaggio iniziale per il ripristino.

12



Fare clic sulla foto della ricetta, accedere all'interfaccia della ricetta, fare clic su

per controllare tutti i dettagli della ricetta. Fai clic su per iniziare e per la raccolta preferita.

13

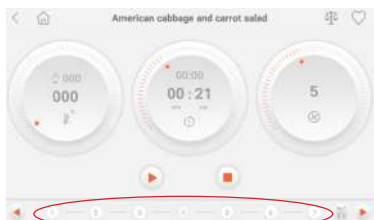

La ricetta ha parametri preimpostati. Fai clic su per iniziare. Il numero nel cerchio rosso indica ogni passaggio di lavoro, fare clic su per controllare tutti i dettagli della ricetta.

14

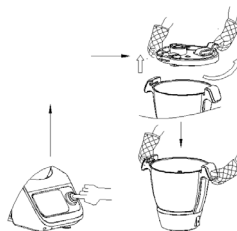

Dopo aver cucinato lo schermo mostrerà Fine. Premere la manopola per interrompere la cottura. Se si desidera sospendere durante la cottura, premere la manopola. Quindi premere di nuovo e il fornello continuerà la cottura. La cucina smetterà di cuocere se si preme a lungo la manopola.

15

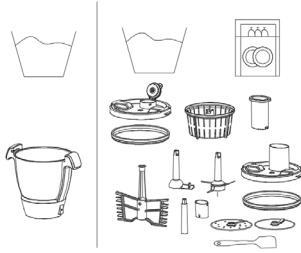





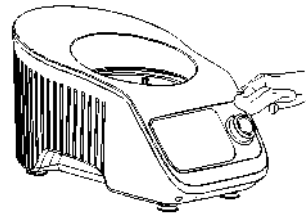







Accessori che possono essere messi in lavastoviglie.



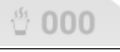





















16











Pulire l'unità principale

6. Panoramica del pannello di controllo

Numero di serie	Icona	Descrizione della funzione
12		(1) Può essere usato per impostare temperatura, tempo, velocità; o IU, programma automatico, ricetta. (2) Premere la manopola e il fornello interromperà la cottura. Continuerà la cottura se si preme di nuovo. O conferma la tua scelta. (3) Premere a lungo la manopola e il fornello smetterà di cucinare. (4) Premere la manopola dopo aver completato tutte le impostazioni e la cottura inizierà la cottura. (5) Si annullerà automaticamente se si preme a lungo la manopola durante l'impostazione. (6) Al termine della cottura, premere la manopola e il fornello entrerà in modalità standby.
27.1		Inverso Gamma di velocità: 1-3
27.2		Velocità: Fare clic su  per spostarsi tra orario e retromarcia Gamma di velocità: 0-12
26		Visualizzazione del parametro orario impostato: 0-90 minuti Visualizzazione del tempo di funzionamento: 0-90 minuti
25.1		Visualizzazione del parametro di temperatura impostato Intervallo di temperatura: 37-120 °C Dopo 37, 40°C, a intervalli di 5 °
25.2		Icona Chiudi / Apri
25.3		Temperatura alimenti / ingredienti: dopo 37, 40°C, a intervalli di 5 °
28		 : pulsante di avvio,  : pausa,  : arresto
30		Pulsante di configurazione: imposta o controlla le informazioni di cottura del robot, tra cui: Wifi, versione del sistema, lingua, ecc.

31		Pulsante Home: home page	
32		Pulsante peso	
33.1		Impastare: Tempo: 3 (intervallo: 2-4) minuti Temp: 000 (Range: 000-37)°C Velocità: 2 (intervallo: 1-3)	
33.2		Vapore: Tempo: 20 (intervallo: 1-60) minuti Flusso di vapore: Veloce / Medio / Lento Il conto alla rovescia inizia da 95 °C	
33.3		Cottura lenta Tempo: 60 (intervallo: 10-90) minuti Temp: 100 (Range: 60-100) °C Velocità: 1 (intervallo: 1-3)	
33.4		Bollire Temp: 100 (Range: 60-100) °C	
33.5		Robot da cucina Tempo: 30 (intervallo: 10-60) secondi Velocità: 5 (intervallo: 5-7)	
33.6		Tritare Tempo: 10s (Gamma: 10s-4m) Velocità: 6 (intervallo: 1-12)	
33.7		Turbo Tempo: 60s Velocità: 12 Premere  o Premere la manopola e rilasciare per interrompere	
33.8		Pesare Max: 5Kgs Intervallo di 5 g	
33.8.1		Tara	
33.8.2		Fine della pesatura	
34		Gestione degli ordinamenti	
35		A-Z	
36		Ricerca	

37		Più Compresi la raccolta e la storia preferite
44		Uscita
45	 	Favorite / Storia
46		Ingredienti Picto
47		Fase di cottura
48		I consigli dello chef
49		Accessori Picto
50		Controlla le informazioni sulla ricetta incluso

7. Impostazione dell'ora

7.1: Intervallo di tempo: 0-90 minuti

7.2: Fare clic su  , fare clic su min o sec, scorrere o ruotare la manopola per impostare l'ora

8. Impostazione della temperatura

8.1: Intervallo di temperatura: 37-120°C, con intervallo di 5°C

8.2: Fare clic su  far scorrere l'immagine o ruotare la manopola per impostare la temperatura

9. Impostazione della velocità

9.1: Intervallo di velocità: 0-12

9.2: Fare clic  , scorrere l'immagine o ruotare la manopola per impostare la velocità

9.3  : fare clic  , passare a  , con impostazione della velocità 1-3

9.4:  velocità 1-3:

 velocità 1-4:

 velocità 1-12

10. Avvio, pausa e arresto

10.1  Avvio

10.2  Pausa

10.3  Arresto

Durante la modalità standby, le luci bianche e rosse lampeggiano. La luce rossa sotto la manopola è accesa quando la temperatura è superiore a 60°C e la luce bianca è accesa quando la temperatura è inferiore a 60°C, in qualsiasi modalità

11. Utilizzo suggerito

Metodo				
Funzione	Accessorio	Velocità	Tempo	Massima cottura degli ingredienti in una sola volta
Tritare carne	Accessorio	Velocità 8-12	30s-60s	600 g di manzo / maiale senza osso / tendine
Schiacciata del ghiaccio	Lama per tagliare	Velocità 8-12	10-20s	600g cubetto di ghiaccio
Miscelatore	Lama per tagliare	Velocità 12	1min	Capacità massima: 2300 ml 920 g di carota 1380 g di acqua
Tritare (Cipolla, scalogno, sedano, ecc.)	Lama per tagliare	Velocità 5	15s-30s	500g
Impastamento	Lama per tagliare	Velocità 1	2mins	500 g di farina + 250 g di acqua + 20 g di olio
Fette, brandelli (Carota, Cetriolo, Patata)	dischi per affettare	Velocità 5-6	30s	500g
Zuppa	Pagaia per mescolare	Velocità 1	Scegli la funzione Zuppa. Oppure puoi impostare il tempo, la velocità e la temperatura corretti da solo.	Capacità massima 2000 ml

12. Cura e pulizia:

12.1. Spegner e scollegare sempre prima di pulire.

12.2. Rimuovere il coperchio e lo strumento dalla ciotola prima della pulizia,

12.3. Unità di potenza. Pulire con un panno umido, quindi asciugare. Non usare mai abrasivi o immergere in acqua.

12.4. Quando c'è un segno di bruciatura sul fondo della brocca del frullatore, metti un po' di acido citrico o limoni in acqua, scaldi per 5 ~ 7 minuti, quindi rimuovi il segno di bruciatura con un mocio



12.5. Ciotola / paletta per mescolare / lama. Lavare le parti, quindi asciugare accuratamente. Se il cibo o le bruciature si attaccano all'interno della ciotola, rimuovere il più possibile usando una spatola. Riempi la ciotola con acqua calda e sapone e lascialo in ammollo. Rimuovere eventuali depositi ostinati usando una spazzola per la pulizia. Qualsiasi scolorimento della ciotola non influirà sulle sue prestazioni.

12.6 Come estrarre il cestino del vapore

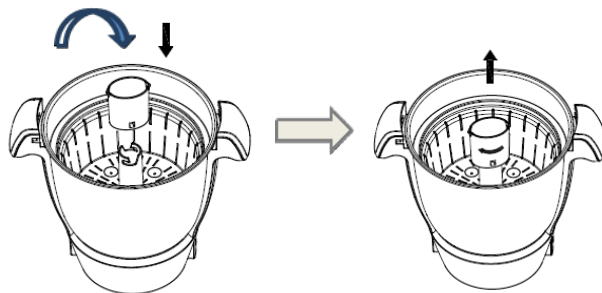
Metti il misurino nella fessura del cestello del vapore e ruota per fissarlo. Quindi, togliti.

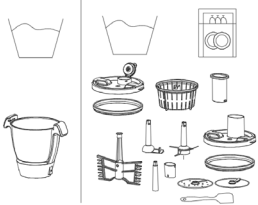

13. Pulizia e manutenzione

Scollegare il cavo di alimentazione prima di pulirlo	Si prega di utilizzare un panno asciutto per pulire l'unità principale. Non lavare con acqua o mettere in lavastoviglie.
<p>Coperchio, misurino, lama, paletta per miscelazione, cestello per cottura a vapore, piroscapo, ecc. Tutti gli accessori fotografici sopra indicati possono essere lavati in lavastoviglie.</p> 	<p>Spazzole metalliche, spazzole di nylon, detergenti per la casa, diluenti, prodotti per la pulizia, ecc. Danneggiano la superficie della struttura del prodotto</p> 
Utilizzare un panno asciutto e morbido per pulire il cavo di alimentazione.	

14. Specifiche del prodotto

Modello: SS-14565

Tensione nominale: 220-240V~ 50-60Hz

Potenza di riscaldamento: 1000W

Potenza di miscelazione: 600W

Capacità della ciotola: 2.0L/3.5L(Max)

Potenza di riscaldamento + Potenza di miscelazione: 1300W

15. Ripristinare il controllo della temperatura



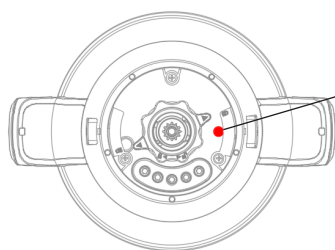



Se la macchina smette di funzionare a causa della sovratemperatura, è possibile premere il pulsante di ripristino della temperatura situato nella parte inferiore della brocca. Assicurarsi che la caraffa si raffreddi e quindi farla funzionare di nuovo.

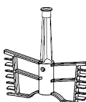

Pulsante di ripristino della temperatura
Premilo e "clicca"

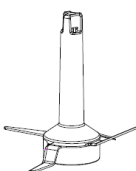
**VISTA DAL BASSO
DELLA BROCCA**

16. Panoramica degli accessori

Parte fondamentale	Funzione	Velocità	Tempo	Temperatura°C	
	Frusta	Montare l'albume	4	2-4 minuti	---
		Panna montata	3	3-5 minuti	---
	Pagaia per mescolare	Zuppa	1-2	1-90 minuti	100°C
		Altri ingredienti che devono essere riscaldati	1-2	Secondo necessità	Secondo necessità
	Lama	Tritare la carne	8-12	30-60s	---
		Zucchero tritato	8-12	10-20s	--
		Miscelatore	8-12	1-2 minuti	---
		Tagliere (Cipolla, scalogno, sedano ecc)	5-7	15-60s	---
		Fagiolo, Soia, Noce, Arachidi, Chicco di caffè, mandorla	12	2-3 minuti	---
		Impastamento	1	1-2 minuti	--
	Cesto a vapore	Riso ecc	---	20-30 minuti	100-110°C
	Affettatrice/ dischi per affettare	fette	5-6	30-60s	--
	Piroscafo	Pesce...	---	10-60 minuti	110-120°C

Tuto příručku lze stáhnout také z naší webové stránky www.sogo.es

Před prvním použitím si důkladně přečtěte instrukce

1. Přečtěte si pozorně tyto pokyny a uschovejte návod pro budoucí použití.
2. Před výměnou příslušenství nebo částí, které se pohybují při používání, přístroj vypněte a odpojte od napájení.
3. Dbejte, aby se části těla, šperky a volné oblečení nedotýkalo pohyblivých částí a namontovaných nástavců.
4. Před vylitím obsahu z misky vždy vyjměte mixovací nože.
5. Pokud je přístroj zapojen, nedávejte do mísy ruce nebo jiné nádoby.
6. Nikdy nepoužívejte přístroj pokud je poškozený. Nechte ho zkontrolovat nebo opravit.
7. Nepřekračujte maximum vyznačené na vnitřní straně mísy.
8. Pohon přístroje, kabel nebo zástrčka nesmí navlhnout.
9. Při režimu vaření a po něm, opatrně manipulujte s mísou, víkem a příslušenstvím, které vydrží HORKÉ dlouho po vypnutí přístroje.
10. Pro manipulaci s nádobou používejte úchyty. Pokud je nádoba horká, použijte ochranné rukavice.
11. Spodní strana mísy zůstane horká dlouho od konce ohřívání, proto s ní manipulujte opatrně a pokud ji chcete položit, použijte vhodnou

podložku.

12. Držte se mimo dosah páry, zejména si dávejte pozor při sundávání víka.
13. Při vaření tekutiny nesundávejte víko ani uzávěr plnicího otvoru.
14. Při použití funkce sekání, vždy uzavřete uzávěr plnicího otvoru.
15. Používejte pouze mísu a příslušenství dodané s tímto přístrojem. Nikdy nezahřívejte mísu jiným způsobem.
16. Nikdy nepoužívejte funkci vaření, je-li nádoba prázdná.
17. Nepoužívejte víko k ovládání přístroj. Pokud je uzavírací mechanismus vystaven nadměrné síle, dojde k jeho poškození a může dojít k zranění.
18. Při používání přístroje se ujistěte, že je umístěn na rovné ploše a daleko od kraje. Neumísťujte pod skříňku.
19. Pro správné a bezpečné použití se ujistěte, že jsou nádoba a snímače tepla před vařením čisté a suché.
20. **UPOZORNĚNÍ: Aby se předešlo nebezpečí způsobeného neúmyslným resetováním tepelného vypínače, nesmí být tento přístroj napájen externím spínacím zařízením, například časovačem, nebo být připojen k obvodu, který se pravidelně zapíná a vypíná.**
21. Před jídlem se vždy ujistěte, že je jídlo důkladně uvařené a teplé.
22. Jídlo by se mělo sníst krátce po uvaření nebo nechat vychladnout a umístit do ledničky.
23. Nesprávné použití přístroje může způsobit zranění.

24. Příklad mohou používat osoby se sníženými tělesnými, smyslovými nebo duševními schopnostmi a/nebo nedostatkem znalostí a zkušeností, pouze pokud jsou pod dohledem a pokud byly poučeny o bezpečném používání a pochopily s ním související rizika.
25. Děti si nesmí s přístrojem hrát.
26. Děti nesmí tento přístroj používat. Skladujte přístroj a kabel z dosahu dětí. Nenechávejte viset kabel tam, kde by ho mohlo dítě chytit.
- 27. UPOZORNĚNÍ: Při manipulaci s ostrými noži, vyprazdňování a čištění mísy buďte opatrní.**
28. Pokud je přístroj bez dozoru nebo před montáží, demontáží, čištěním, přístroj vždy vypojte z napájení.
29. Pokud je napájecí kabel poškozen, musí být nahrazen kabelem od výrobce nebo servisního zástupce, aby nedošlo k nebezpečí.
30. Příklad používejte pouze k určenému domácímu užití. Nepřijmeme žádnou odpovědnost, pokud jste přístroj nesprávně použili nebo nedodrželi tyto pokyny.
31. Maximální nálož při míchání je 920 g mrkve/1380 g vody.
32. Horkou tekutinu nalévejte opatrně, aby vás neopařila pára, která si při nalití vypařuje.
33. Příklad používejte pouze s dodaným stojanem.
34. Příklad nikdy nepoužívejte venku.
35. Vyvarujte se rozlití konektoru.
36. Nerozebírejte dno mísy (včetně krytu držadla), není určeno pro údržbu uživatelem.
37. Po zastavení motoru (pokud byl zapnut) poběží chladicí ventilátor 2 min.

38. Během používání se může povrch zahřát.



39. Informace o čištění povrchů, které přicházejí do styku s potravinami, naleznete v části Péče a čištění.

40. UPOZORNĚNÍ: Před vyjmutím ze základny se ujistěte, že je přístroj vypnutý.

Před zapojením

Ujistěte se, že váš přívod elektřiny je stejný jako ten, který je uveden na spodní straně vašeho spotřebiče.

UPOZORNĚNÍ: TENTO SPOTŘEBIČ MUSÍ BYT UZEMNĚN.

1. Přehled přístroje

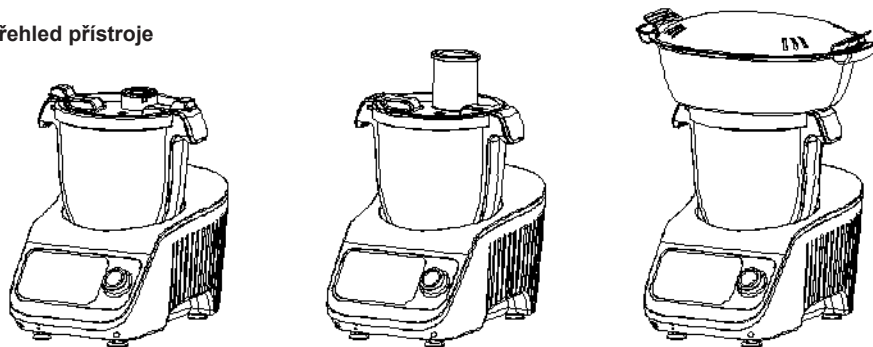

2. Části

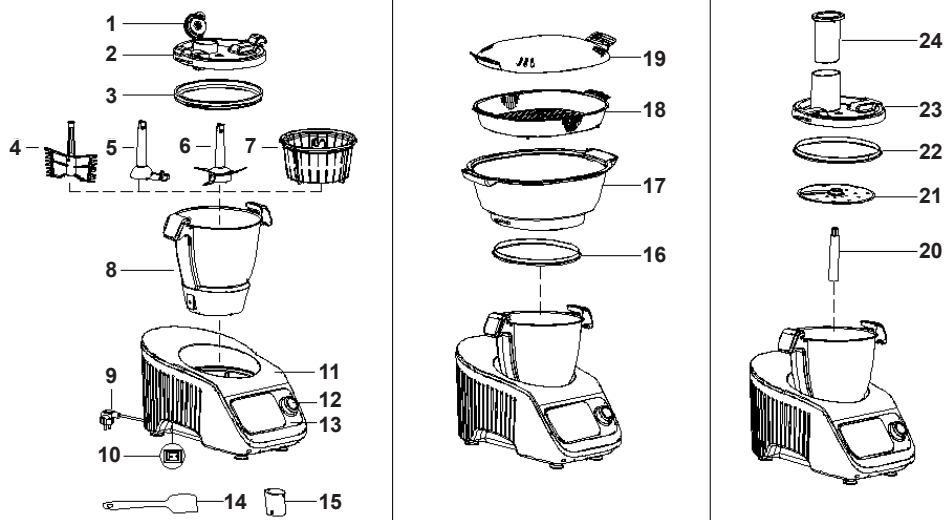

3. Displej

1) Vlastní nastavení

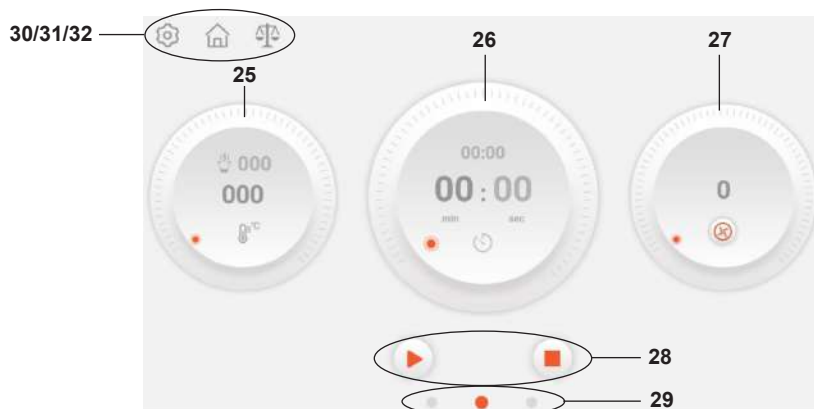

2) Automatické programy

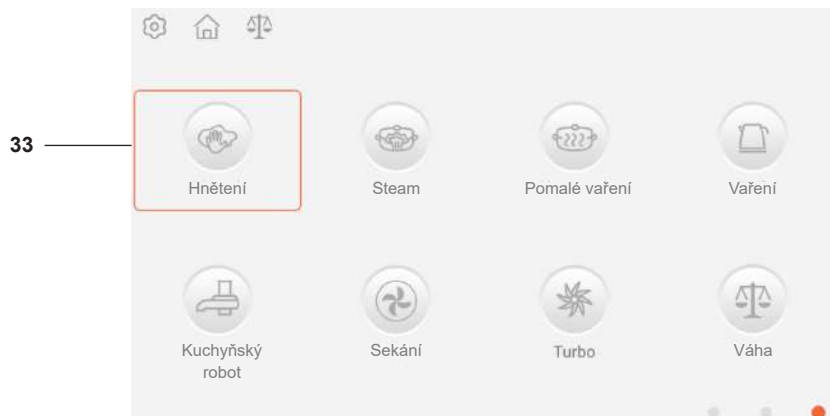

3) Recepty

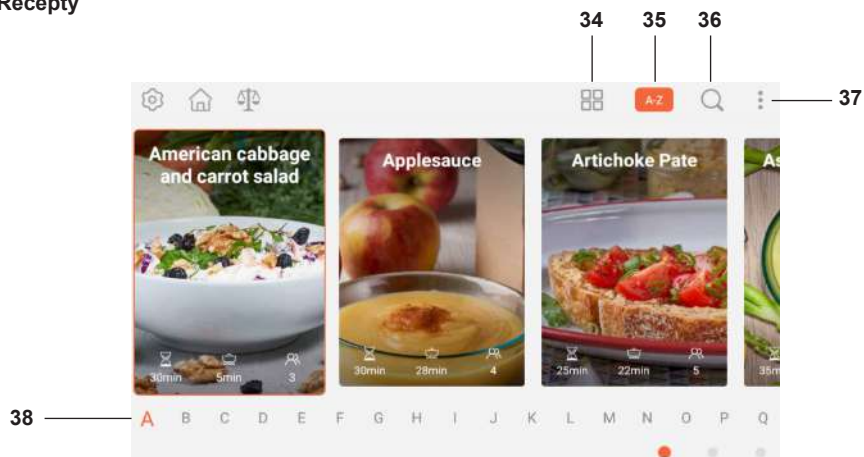

4) Nastavení

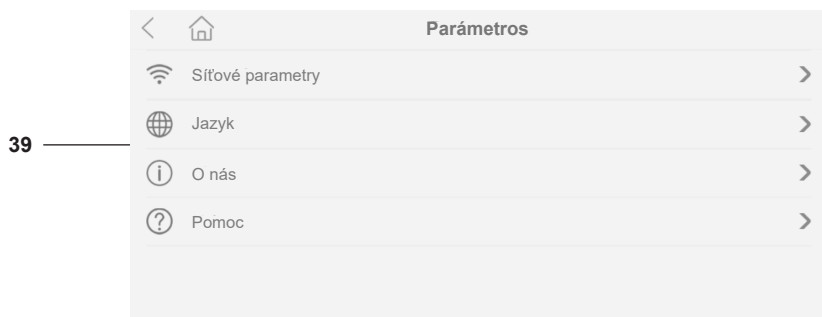







5) Domovská stránka

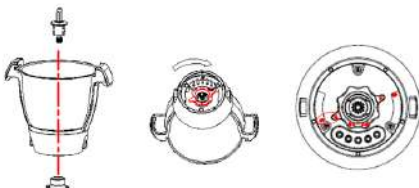

4. Popis částí

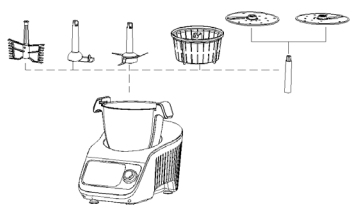
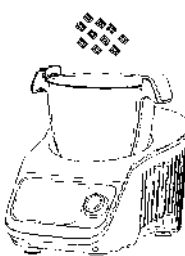
Č.	Název	Č.	Název	Č.	Název
1	Plnicí otvor	16	Těsnění hlubokého parného košíku	31	Tlačítko hlavní nabídka
2	Víko	17	Hluboký parný košík	32	Tlačítko váhy
3	Těsnění víka	18	Mělký parný košík	33	Tlačítko funkcí
4	Metlička	19	Víko parný košíku	34	Seřazení
5	Míchací lopatka	20	Hřídél	35	A-Z
6	Mixovací nože	21/21A	Nůž na sekání a krájení	36	Tlačítko vyhledávání
7	Varný košík	22	Těsnění na kráječ	37	Tlačítko možnosti
8	Mixovací nádoba	23	Víko na kráječ	38	A-Z tlačítko
9	Napajecí kabel	24	Přítlak	39	Nastavení
10	Hlavní zapínač	25	Tlačítko teploty	40	Recepty
11	Základna přístroje	26	Časovač	41	Vlastní nastavení
12	Hlavní ovladač	27	Tlačítko rychlosti	42	Automatické programy
13	Displej	28	Tlačítko Star/Pauza/Konec	43	Stahování
14	Stěrka	29	Stránky		
15	Odměrka	30	Tlačítko nastavení		

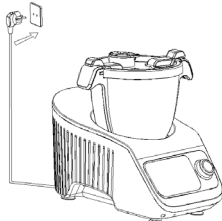
5. Sestavení před použitím

<p>1</p>  <p>Správně umístěte hřídel do nádoby.</p>	<p>2</p>  <p>Vložte nádobu do základny. Zatlačte pevně dolů, aby zapadla (LOGO vpředu), (max. vzadu).</p>
<p>3</p>  <p>Vyberte různé příslušenství pro různé druhy vaření.</p>	<p>4</p>  <p>Vložte do nádoby ingredience nebo vodu. Nasadte víko na nádobu a ostatní přísady přidávejte plnicím otvorem.</p>
<p>5</p>  <p>Nasadte víko nádoby nebo varného košíku.</p>	<p>6</p>  <p>Zapojte kabel a zapněte přístroj.</p>
<p>7</p>  <p>Stisknutím nebo otočením příslušného tlačítka nastavíte teplotu, čas a rychlost. Kliknutím na minutu nebo sekundu nastavíte rychle přesný čas. Funkce zpětného chodu: Stiskněte ikonu ▶</p>	<p>8</p>  <p>Stiskněte ▶ po nastavení teploty, času a rychlosti, poté se ikona změní na , přístroj nyní vaří.</p> <p>Stisknutím pozastavíte vaření. Stisknutím ■ nebo nepřetžitým zmáčknutím zastavíte vaření a ukončíte program.</p>

9



Posunutím nebo stisknutím pravé tečky v červeném kruhu nebo otočením hl. ovladače ve směru hodinových ručiček přejdete do nabídky funkcí. Stisknutím nebo prostřední tečky v červeném kruhu přejdete zpět do hlavní nabídky

10



Stiskněte ikonu požadované funkce. Po dokončení kroku 7 a 8 začnete vařit. Stiskněte pro ukončení. Tato ikona je pro napařování.

11

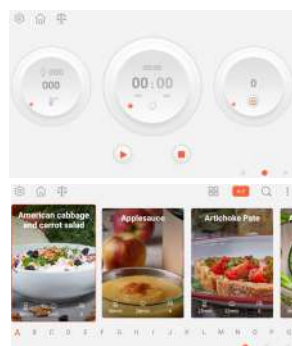

Posunutím nebo stisknutím levé tečky v červeném kruhu nebo otočením hl. ovladače v protisměru hodinových ručiček přejdete do nabídky receptů. Stisknutím se vrátíte zpět. Click the or click the middle dot in red circle to go back to the initial step for reset.

12



Klikněte na fotografii požadovaného receptu, stiskněte



pro podrobnosti receptu. Stisknutím začnete vařit a stisknutím přidáte do oblíbené kolekce.

13

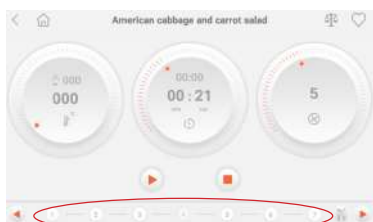

Recept má přednastavené parametry. Stiskněte pro start. Čísla v červeném kruhu jsou jednotlivé kroky, stisknutím zkontrolujete podrobnosti receptu.

14

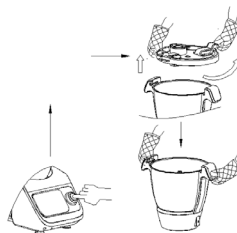

Po vaření se na displeji zobrazí konec. Stisknutím hl. ovladače zastavíte vaření. Pokud chcete během vaření pozastavit stiskněte hl. ovladač. Poté ho znovu stiskněte pro pokračování ve vaření. Pro ukončení vaření hl. ovladač stiskněte dlouze.

15

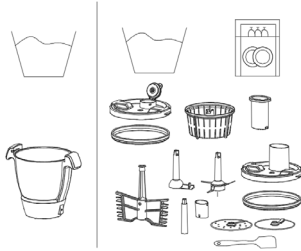

Příslušenství, které lze vložit do myčky.



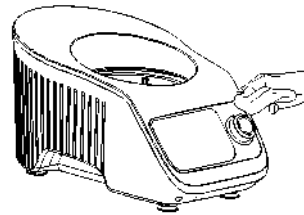





















16











Otřete základnu.

6. Control Panel Overview

Sériové číslo	Ikona	Popis funkce
12		(1) Nastavení teploty, času, rychlosti. Ovládání displeje, automatických programů a receptů. (2) Stiskněte, a přístroj se při vaření pozastaví. Pokud opět stisknete, vaření bude pokračovat. Nebo jím potvrďte svůj výběr. (3) Dlouhým stisknutím přestane přístroj vařit. (4) Po dokončení všech nastavení stiskněte hl. ovladač a přístroj začne vařit. (5) Pokud při nastavování hl. ovladač dlouze stisknete, všechna nastavení se automaticky zruší. (6) Po dokončení vaření stiskněte hl. ovladač, a přístroj se přepne do základního režimu.
27.1		Zpětný chod Rychlosti: 1-3
27.2		Rychlost: Stiskněte pro změnu směru. Rozsah rychlosti: 0-12
26		Nastavení časovače: 0-90 minute Doba vaření: 0-90 minute
25.1		Nastavení teploty Rozsah teploty: 37-120°C Po 37, 40°C, pouze v intervalech 5°
25.2		Ikona otevřít/zavřít
25.3		Teplota jídla/přísad, po 37, 40°C, pouze v intervalech 5°
28		: star, : pozastavení, : konec
30		Tlačítko Nastavení: pro nastavení nebo zkontrolování informací o robotu včetně: Wifi, verze systému, jazyk, atd.

31		Tlačítko Domů: Hlavní nabídka	
32		Tlačítko Váha	
33.1		Hnětení: Čas: 3 (Možnosti:2-4) minuty Teplota: 000(Možnosti:000-37) °C Rychlost: 2 (Možnosti:1-3)	
33.2		Štěrnutí: Čas: 20 (Možnosti:1-60) minut Průtok páry: Rychlý/Střední/Pomalý Odpočet času začíná od 95°C	
33.3		Pomalé vaření Čas: 60 (Možnosti:10-90) minut Teplota: 100 (Možnosti:60-100) °C Rychlost: 1 (Možnosti:1-3)	
33.4		Vaření Teplota: 100 (Možnosti: 60-100) °C	
33.5		Kuchyňský robot Čas: 30 (Možnosti:10-60) sekund Rychlost: 5 (Možnosti:5-7)	
33.6		Sekání Čas: 10s (Možnosti:10s-4min.) Rychlost: 6 (Možnosti:1-12)	
33.7		Turbo Čas: 60s Rychlost: 12 Klikněte  nebo stisknutím hlavního ovladače Turbo ukončíte.	
33.8		Váha Maximum: 5Kg Interval po 5g	
33.8.1		Vynulování váhy	
33.8.2		Ukončení váhy	
34		Seřazení	
35		A-Z	
36		Hledat	

37		Více Včetně kolekce oblíbených receptů a historie
44		Odejít
45	 	Oblíbené/Historie
46		Ingredience
47		Postup vaření
48		Tipy šéfkuchaře
49		Příslučenství
50		Kontrola detailů receptu

7. Nastavení času

7.1: Možnosti nastavení času: 0-90 minut

7.2: Klikněte na  , klikněte na minuty nebo vteřiny, posunutím nebo stisknutím hl. ovladače nastavíte čas.

8. Nastavení teploty

8.1: Možnosti nastavení teploty: 37-120°C, s 5°C intervaly

8.2: Stiskněte  posunutím tlačítkem na obrazovce nebo otočením hl. ovladače nastavíte teplotu

9. Nastavení teploty

9.1: Možnosti nastavení teploty: 0-12

9.2: Klikněte na  posunutím pictogramem na obrazovce nebo otočením hl. ovladačem nastavíte rychlost.

9.3  : stiskněte  posuňte na  , s nastavením rychlosti 1-3

9.4:  Rychlosti 1-3

 Rychlosti 1-4

 Rychlosti 1-12

10. Start, pozastavení a ukončení

10.1  Comenzar

10.2  Pozastavení

10.3  Ukončení

Během pohotovostního režimu, bliká bílé a červené světlo. Červené světlo pod hlavním ovladačem svítí, pokud je teplota nad 60°C a bílé světlo svítí, je-li teplota pod 60°C, v jakémkoliv pracovním stavu.

11. Doporučené použití

Method				
Funkce	Příslušenství	Rychlost	Čas	Maximální množství vařených ingrediencí najednou
Sekání masa	Nože na sekání	Rychlost 8-12	30s-60s	600g hovězího / vepřového bez kostí/ šlach
Drcení ledu	Nože na sekání	Rychlost 8-12	10-20s	600g kostek ledu
Mixér	Nože na sekání	Rychlost 12	1min	Maximální kapacita: 2300ml 920g mrkve, 1380g vody
Sekání (cibule, šalotka, celer, atd)	Nože na sekání	Rychlost 5	15s-30s	500g
Hnětení	Nože na sekání	Rychlost 1	2mins	500g mouky + 250g vody + 20g oleje
plátky, kousky (mrkev, okurka, brambory)	Nůž na sekání a krájení	Rychlost 5-6	30s	500g
SPolévka	Metlička	Rychlost 1	Zvolte funkci Polévka. Nebo si můžete nastavit vlastní čas, rychlost a teplotu.	Maximální kapacita 2000ml

12. Péče a čištění:

12.1. Před čištěním vždy vypněte a odpojte napájecí kabel.

12.2. Před čištěním sundejte víko a příslušenství z nádoby,

12.3. Otfete pohon přístroje navlhčeným hadříkem, poté otfete. Nikdy nepoužívejte abraziva a neponořujte základnu do vody.

12.4. Pokud je dno nádoby spálené, dejte do vody trochu kyseliny citronové nebo citronové šťávy, zahřejte ji na 5-7min. a poté vytřete hadříkem.

12.5. Nádoba/metlička/nože. Opláchněte tyto díly a poté důkladně osušte. Pokud jídlo uvnitř nádoby přilne nebo připálí, odstraňte co nejvíce špachtlí. Naplňte mísu teplou mýdlovou vodou a nechte ji odmočit.

Odstraňte všechny nečistoty pomocí čistícího kartáče. Jakékoli zbarvení nádoby neovlivní její výkon.

12.6. Jak vytáhnout varný košík

Vložte odměrku do otvoru varného košíku a otočením ji upevněte. Potom vyjměte.

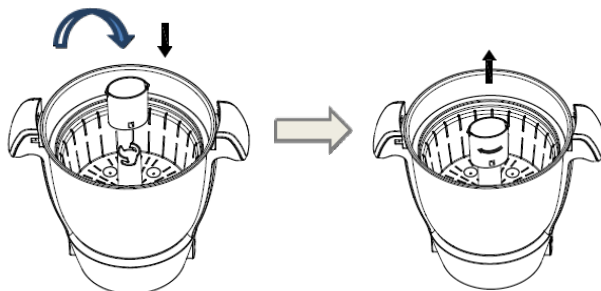

13. Čištění a údržba

Před čištěním odpojte napájecí kabel:	K čištění základny použijte suchou utěrku. Neumývejte ji vodou ani ji nevkládejte do myčky na nádobí.
<p>Víko, odměrka, nože, metlička, Varný košík, atd. Všechno příslušenství na obrázku může být vloženo do myčky na nádobí.</p> 	<p>Kovový kartáč, nylonový kartáč, čisticí prostředek pro domácnost, ředidlo, čisticí prostředky poškodí povrch struktury výrobku.</p> 
K čištění napájecího kabelu použijte suchý a měkký hadřík.	

14. Specifikace produktu

Model: CF-1905/1905FP

Jmenovité napětí: 220-240V, 50-60Hz

Topný výkon: 1000W

Michací síla: 600W

Kapacita nádoby: 2.0L/3.5L(Max)

Topný výkon + Michací síla: 1300W

15. Resetování regulace teploty



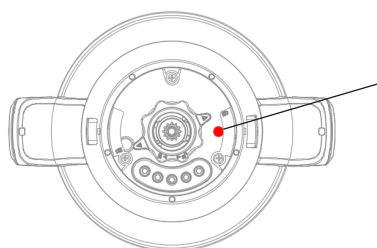



Při přehřátí, nádoba nefunguje. Stisknutím tlačítka teploty můžete resetovat regulaci teploty, po ochlazení nádoby, můžete nádobu použít.

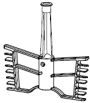

Tlačítko teploty
Stiskněte a klikněte.

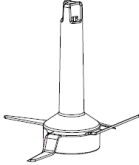
**SPODNÍ POHLED NA
DŽBÁN**

16. Přehled příslušenství

Klíčové části	Funkce	Rychlost	Čas	Teplota °C	
	Metla	Šlehání bílku	4	2 - 4 minuty	---
		Šlehačka	3	3-5 minut	---
	Míchací lopatka	Polévka	1-2	1-90 minut	100°C
		Ohřátí jiných ingrediencí	1-2	As per need	Podle potřeby
	Nože	Sekání masa	8-12	30-60s	---
		Drcení ledu	8-12	10-20s	--
		Mixér	8-12	1-2 minuty	---
		Sekání (cibule, šalotka, celer, atd.)	5-7	15-60s	---
		Fazole, sója, ořechy, arašídy, kávové zrnko, mandle	12	2-3 minuty	---
		hnětení	1	1-2 minuty	--
	Varný košík	Rýže atd.	---	20-30 minut	100-110°C
	Nůž na sekání a krájení	Plátky a kousky	5-6	30-60s	--
	Parný košík	Ryba...	---	10-60 minut	110-120°C

DECLARACIÓN DE CONFORMIDAD

Este dispositivo cumple con la Directiva de baja tensión 2014/35/CE, la Directiva de Compatibilidad Electromagnética 2014/30/UE, la Directiva 2015/863 UE sobre restricciones a la utilización de determinadas sustancias peligrosas en aparatos eléctricos y electrónicos y la Directiva 2009/125 CE en los requisitos de diseño ecológico aplicables a los productos relacionados con la energía.



DECLARAÇÃO DE CONFORMIDADE

Este dispositivo está em conformidade com a Directiva de Baixa Tensão 2014/35/CE, a Directiva de Compatibilidade Electromagnética 2014/30/UE, a Directiva 2015/863/UE relativa à restrição do uso de determinadas substâncias perigosas em equipamentos eléctricos e electrónicos e da Directiva 2009/125/CE sobre os requisitos de concepção ecológica aplicáveis aos produto relacionados com a energia.



DECLARATION OF CONFORMITY

This device complies with Low Voltage Directive 2014/35/EC, Electromagnetic Compatibility Directive 2014/30/EU, Directive 2015/863/EU on the restriction of the use of certain hazardous substances in electrical and electronic equipment and Directive 2009/125/EC on the eco-design requirements applicable to energy-related products.



DICHIARAZIONE DI CONFORMITÀ

Questo dispositivo è conforme alla Direttiva sulla Bassa Tensione 2014/35/EC, Direttiva sulla Compatibilità Elettromagnetica 2014/30/EU, Direttiva 2015/863/EU sulla restrizione dell'uso di determinate sostanze pericolose nelle Apparecchi elettrici ed elettronici e la Direttiva 2009/125/CE relativa ai requisiti di progettazione ecocompatibile applicabili ai prodotti connessi all'energia.



DÉCLARATION DE CONFORMITÉ

Cet appareil est conforme à la Directive Basse Tension 2014/35/CE, la directive Compatibilité électromagnétique 2014/30/UE, la directive 2015/863/UE relative à la limitation de l'utilisation de certaines substances dangereuses dans les équipements et la directive 2009/125/CE électriques et électroniques sur les exigences en matière d'éco conception applicables aux produits liés à l'énergie.



KONFORMITÄTSERKLÄRUNG

Dieses Gerät entspricht die 2014/35/EG Niederspannungs Richtlinie, die 2014/30/EU Elektromagnetische Verträglichkeit Richtlinie, die 2015/863/EU Richtlinie auf die Beschränkung der Verwendung bestimmter gefährlicher Stoffe in Elektro- und Elektronikgeräten und die 2009/125/CE Richtlinie auf die die Ökodesign-Anforderungen für energieverbrauchsrelevante Produkte.



PROHLÁŠENÍ O SHODĚ

Toto zařízení je v souladu se směrnicí o zařízeních nízkého napětí 2014/35 / EC, směrnicí o elektromagnetické kompatibilitě 2014/30 / EU, směrnicí 2015/863 / EU o omezení používání určitých nebezpečných látek v EU elektrických a elektronických zařízení a směrnicí 2009/125 / ES o požadavcích na ekodesign použitelné na energeticky významné výrobky.



Este símbolo significa que, si desea deshacerse del producto, una vez transcurrida la vida del mismo, debe depositarlo por los medios adecuados a manos de un gestor de residuos autorizado para la recogida selectiva de Residuos de Aparatos Eléctricos y Electrónicos (RAEE).



Importado por:

Sanysan Appliances S.L, NIF: B98753056,
C/ Barcas 2, 2
46002 Valencia, España
Producto fabricado en P.R.C - Diseñado por
SOGO basada en las normas de calidad
europeas
Servicio postventa: www.sogosat.com
sogosat@sogosat.com / 0034 902 222 161

Este símbolo significa que se desejar desfazer-se do produto depois de terminada a sua vida útil, deve entregá-lo através dos meios adequados ao cuidado de um gestor de resíduos autorizado para a recolha selectiva de Resíduos de Equipamentos Eléctricos e Electrónicos (RÉEE).



Importado por:

Sanysan Appliances S.L, NIF: B98753056,
C/ Barcas 2, 2
46002 Valencia, Espanha
Producto fabricado na P.R.C - projetado pelo
SOGO com base nas normas de qualidade
europeias.
Serviço pós-venda: www.sogosat.com /
sogosat@sogosat.com / 0034 902 222 161

This symbol means that in case you wish to dispose of the product once its working life has ended, take it to an authorised waste agent for the selective collection of waste electrical and electronic equipment (WEEE).



Imported by:

Sanysan Appliances S.L, NIF: B98753056,
C/ Barcas 2, 2
46002 Valencia, Spain
Product made in P.R.C. – Designed by
SOGO based on the European Quality
Standards
Customer Service: www.sogosat.com /
sogosat@sogosat.com / 0034 902 222 161

Questo simbolo indica che nel caso in qui si desidera smaltire il prodotto una volta la sua vita lavorativa è finite si dovrebbe prendere ad un agente autorizzato di rifiuti per la raccolta selettiva di apparecchi elettriche ed elettroniche (WEEE).



Importato da:

Sanysan Appliances S.L, NIF: B98753056,
C/ Barcas 2, 2
46002 Valencia, Espanha
Prodotto fatto a P.R.C - Disegnato da SOGO
in base alla Norme di Qualità Europea
Servizio al cliente: www.sogosat.com /
sogosat@sogosat.com / 0034 902 222 161

Ce symbole signifie que si vous souhaitez vous défaire du produit, une fois que celui-ci n'est plus utilisable, remettez-le, suivant la méthode appropriée, à un gestionnaire de déchets d'équipements électriques et électroniques (DEEE).



Importé par:

Sanyan Appliances S.L, NIF: B98753056,
C/ Barcas 2, 2
46002 Valencia, Espagne
Produit fabriqué en P.R.C - Conçu par
SOGO sur la base des normes de qualité
européennes.
Service après-vente: www.sogosat.com /
sogosat@sogosat.com / 0034 902 222 161

Dieses Symbol bedeutet, dass für den Fall, möchten Sie das Produkt entsorgen, sobald seine Lebensdauer beendet ist, sollen Sie sich an einen autorisierten Abfallmittel wenden, für die Abfällen von Elektro- und Elektronikgeräten selektive Sammlung (WEEE).



Importiert durch:

Sanyan Appliances S.L, NIF: B98753056,
C/ Barcas 2, 2
46002 Valencia, Spain
Produkt gemacht in P.R.C. -Entworfen von
Sogo auf der Grundlage der europäischen
Qualitätsstandards
Kundendienst: www.sogosat.com /
sogosat@sogosat.com / 0034 902 222 161

Tento symbol znamená, že pokud chcete po skončení životnosti výrobek zlikvidujte skončila, odneste do autorizovaného odpadu agent pro selektivní sběr odpadu elektrických a elektronických zařízení (WEEE).



Importováno:

Sanyan Appliances S.L, NIF: B98753056,
C / Barcas 2, 2
46002 Valencia, Španělsko
Produkt vyrobený v P.R.C. - Navrhl
SOGO vychází z evropské kvality
Standardy
Zákaznický servis: www.sogosat.com /
sogosat@sogosat.com / 0034 902 222 161





SOGO[®]

Human Technology

ref. SS-14565

