

NEW

PTS841 Series Microminiature SMT Side Actuated

Features/Benefits

- 3.6 x 3.5 mm footprint
- 1.25 mm thickness
- ESD pin option
- Peg option
- Commercial grade

Typical Applications

- IoT devices
- Wearables
- Portable devices
- Remote controls

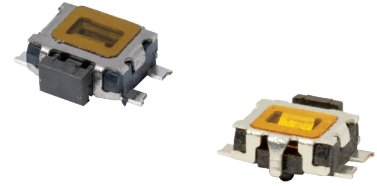

B

Tactile Switches

Specifications

FUNCTION: momentary action
 CONTACT ARRANGEMENT: 1 make contact = SPST N.O.
 TERMINALS: G for SMT
 TRAVEL: 0.2mm ± 0.1 mm
 LIFE: 100,000 cycles

Type	Operating Force (gf)	Pegs	ESD pin option
PTS841 GM SMTR LFS	180 ± 50	No	No
PTS841 GK SMTR LFS	250 ± 50	No	No
PTS841 GMP SMTR LFS	180 ± 50	Yes	No
PTS841 GKP SMTR LFS	250 ± 50	Yes	No
PTS841 ESD GM SMTR LFS	180 ± 50	No	Yes
PTS841 ESD GK SMTR LFS	250 ± 50	No	Yes
PTS841 ESD GMP SMTR LFS	180 ± 50	Yes	Yes
PTS841 ESD GKP SMTR LFS	250 ± 50	Yes	Yes

Electrical

MAXIMUM VOLTAGE: 12 VDC
 MAXIMUM CURRENT DC: 50 mA
 DIELECTRIC STRENGTH: 250 VA C (1mn)
 CONTACT RESISTANCE: ≤ 100 mΩ Initial
 INSULATION RESISTANCE: ≥ 100 MΩ
 BOUNCE TIME: ≤ 5 ms

Environmental

OPERATING TEMPERATURE: -40°C to 85°C

Process

SOLDERING: This component is suited to the following methods:
 Infrared Reflow Soldering in accordance with IEC61760-1

Packaging

In reels of 3,000 pieces
 Dimensions of reels according to EIA 481B
 External diameter 330 mm

NOTE: Specifications listed above are for switches with standard options.
 For information on specific and custom switches, consult Customer Service Center.

How To Order

Our easy build-a-switch concept allows you to mix and match options to create the switch you need. To order, select desired option from each category and place it in the appropriate box.

For any part number different from those listed above, please consult your local representative.

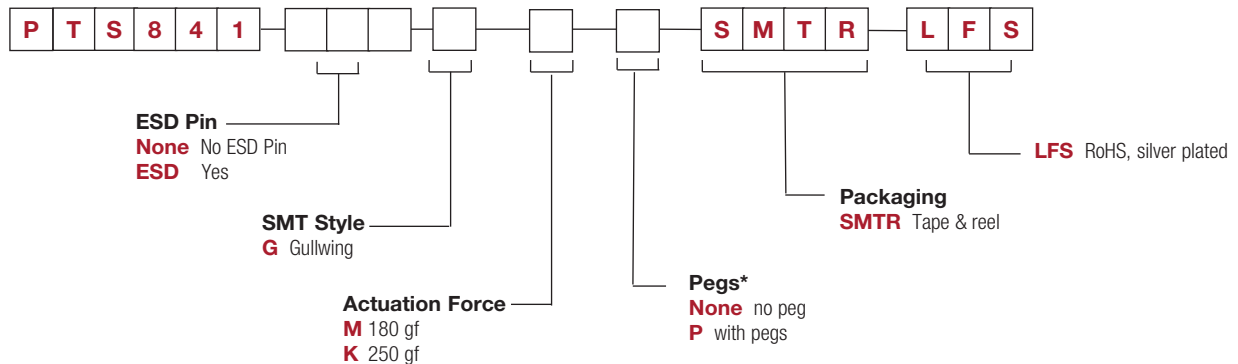

Design Recommendations

* When a precise alignment between application button and the switch is requested, version with pegs are the right choice to limit the possible floating of the switch during solderability.

PTS 841 Series Microminiature SMT Side Actuated

NEW

G SMT Leads with ESD and Peg options

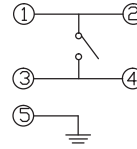
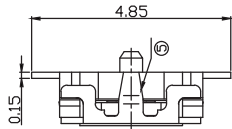

CIRCUIT DIAGRAM

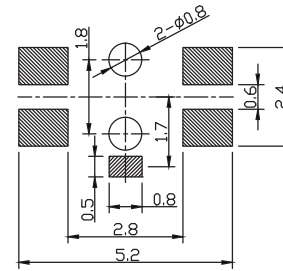
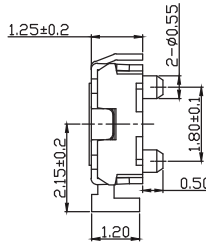
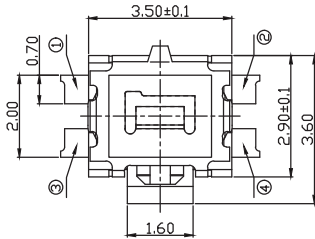

P.C.B LAND DIMENSION

Tactile Switches

B

TAPE & REEL

