

# S Series Slide Switches

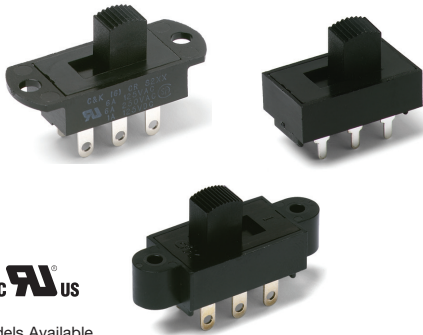

Models Available

## Features/Benefits

- 6 to 15 AMPS
- Enclosed housing
- PC and Snap-in panel mounting
- Reversing option
- RoHS compliant

## Typical Applications

- Portable tools
- Small appliances
- Floor care products

## Specifications

**CONTACT RATING:** Q contact material (S1XX, S2XX Models): 6 AMPS @ 125 V AC; 6 AMPS @ 250 V AC; 1 AMP @ 125 V DC . (S5XX, S6XX Models): 12 AMPS @ 125 V AC; 6 AMPS @ 250 V AC; 1 AMP @ 125 V DC . (S7XX, S8XX Models): 15 AMPS @ 125 V AC; 6 AMPS @ 250 V AC . See page I-32 for additional ratings.

**ELECTRICAL LIFE:** 10,000 make-and-break cycles at full load.

**CONTACT RESISTANCE:** Below 10 m Ω typ. initial @ 2-4 V DC, 100 mA, for both silver and gold plated contacts.

**INSULATION RESISTANCE:** 10<sup>9</sup> Ω min.

**DIELECTRIC STRENGTH:** 1,000 Vrms min. @ sea level.

**OPERATING TEMPERATURE:** -30°C to +65°C

**STORAGE TEMPERATURE:** -30°C to +85°C

## Materials

**HOUSING:** 6/6 nylon (UL94V-2), black.

**TOP PLATE:** 6/6 nylon (UL94V-2), black.

**ACTUATOR:** 6/6 nylon (UL94V-2), black (standard).

**CONTACTS:** Q contact material: Copper, silver plated. See page I-32 for additional contact materials.

**TERMINALS:** Q contact material: Copper, silver plated. See page I-32 for additional contact materials.

**CONTACT SPRING:** Music wire or stainless steel.

**TERMINAL SEAL:** Epoxy.

**NOTE:** Any models supplied with Q, B or G contact material are RoHS compliant.

**NOTE:** Specifications and materials listed above are for switches with standard options. For information on specific and custom switches, consult Customer Service Center.

## Build-A-Switch

To order, simply select desired option from each category and place in the appropriate box. Available options are shown and described on pages I-29 through I-32. For additional options not shown in catalog, consult Customer Service Center.

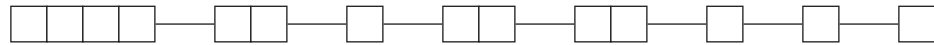

### Switch Function

- S101** SPST, 6 AMPS
- S202** (DPDT, 6 AMPS
- S802** DPDT, 15 AMPS
- S102** SPDT, 6AMPS
- S112** SPDT, mom., 6 AMPS
- S201** DPST, 6 AMPS
- S602** DPDT, 12 AMPS
- S701** SPST, 15 AMPS
- S702** SPDT, 15 AMPS

### Actuator

- 03** .335" high
- 04** .500" high
- 09** .250" high
- 12** Screwdriver slot (with marking)
- 13** Screwdriver slot (without marking)
- C2** Black cap
- C3** Red cap
- C5** Yellow cap

### Detent

- 1** With detent
- 2** Without detent

### Mounting Style

- SS** Panel with mounting ears
- MS** PC thru-hole
- S2** Snap-in panel with blacktop plate
- TS** Panel with mounting ears

### Terminations

- 03** Solder lug with hole
- 02** PC Thru-hole
- 04** PC Thru-hole
- 07** Quick connect
- 08** PC Thru-hole
- WC** Wire lead

### Housing Markings

- NONE** No markings
- D** ON-OFF
- L** ON
- M** ON-OFF
- N** Red rectangle on one end

### Contact Material

- Q** Silver
- B** Gold
- G** Gold over silver

### Seal

- NONE** No seal
- E** Epoxy seal



Dimensions are shown: Inch (mm)  
Specifications and dimensions subject to change

# S Series Slide Switches

## SWITCH FUNCTION



NO. POLES	MODEL NO.	AMP RATING	SWITCH FUNCTION	SCHEMATIC	AVAILABLE MOUNTING STYLES
SP	<b>S101</b>	6	SPST		SS
	<b>S102</b>	6	SPDT		MS,SS
	<b>S112</b>	6	SPDT-MOM.		MS,SS
	<b>S701</b>	15	SPST		S1,S2,S3,ST
	<b>S702</b>	15	SPDT		S1,S2,S3,ST

NO. POLES	MODEL NO.	AMP RATING	SWITCH FUNCTION	SCHEMATIC	AVAILABLE MOUNTING STYLES
DP	<b>S201</b>	6	DPST		MS,SS,TS
	<b>S202</b>	6	DPDT		MS,SS,TS
	<b>S602</b>	12	DPDT		MS,SS,TS
	<b>S802</b>	15	DPDT		S1,S2,S3,ST

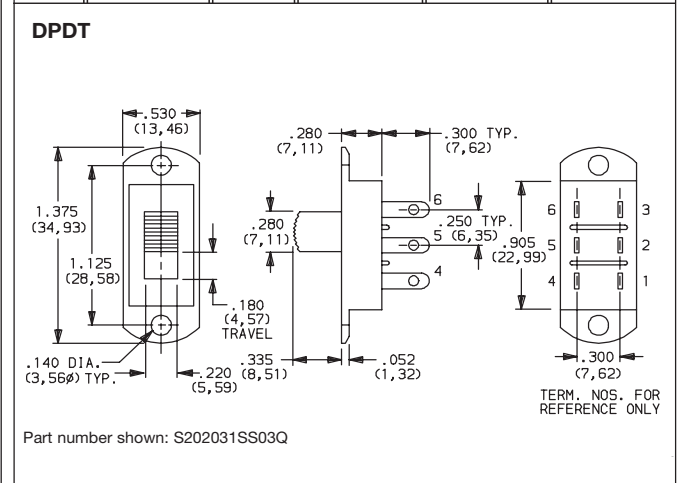
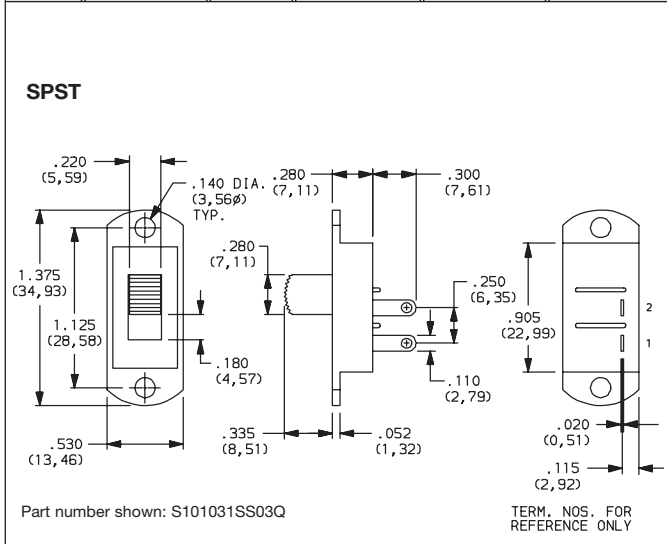

**NOTE:** and MOM. in table indicates momentary action.

All models with all options when ordered with 'G' or 'Q' contact material.

Contacts make on side actuator thrown.

## ACTUATOR



**03** .335" HIGH

**04** .500" HIGH

**09** .250" HIGH

**12** SCREWDRIVER SLOT (WITH MARKING)

**13** SCREWDRIVER SLOT (WITHOUT MARKING)

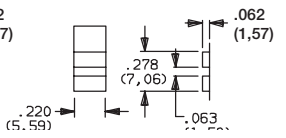
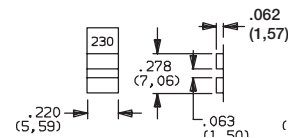
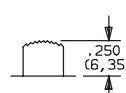
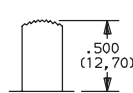
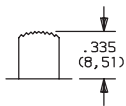

**NOTE:** Standard actuator color is black, other colors available, consult Customer Service Center. Alternate heights are available with '03, 04 and 09' actuators, consult Customer Service Center. Models with S2 mounting style, subtract .090 (2,29). Actuators '12' and '13' are available with DPST and DPDT models only.

White 115-230 markings (std.).

Without markings.

**C2; C3; C5** SNAP-ON CAP

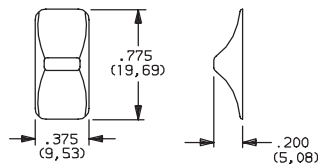

Available with S2 mounting style only.

OPTION CODE2	C1-CT CAP COLOR
<b>C2</b>	BLACK
<b>C3</b>	RED
<b>C5</b>	YELLOW

**NOTE:** Actuator finish: matte. If no color is specified, black will be supplied. Colored actuator caps may also be ordered separately and user installed, see page I-32.

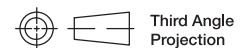

Dimensions are shown: Inches (mm)  
Specifications and dimensions subject to change

# S Series Slide Switches

## DETENT

- 1 WITH DETENT**  
Standard with all maintained models: S101, S102, S201, S202, S602, S701, S702, and S802.
- 2 WITHOUT DETENT**  
Standard with all momentary models: S112.

## MOUNTING STYLE

### SS PANEL WITH MOUNTING EARS

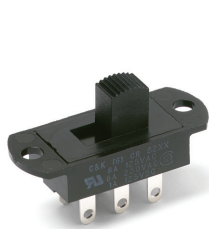

S202031SS03Q  
DPDT

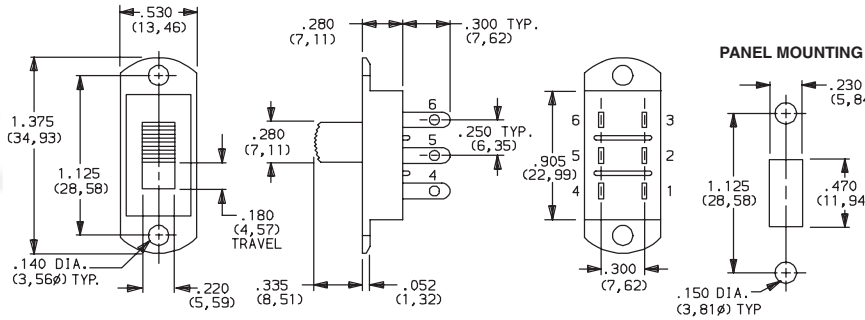

**AVAILABLE WITH:**  
Models: S101, S102, S112, S201, S202 and S602  
Terminations: All except 08  
Actuators: 03, 04, 09, 12\* and 13\*  
\*12 and 13 actuators not available with S1XX models.

### MS PC THRU-HOLE

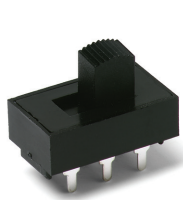

S202031MS02Q  
DPDT

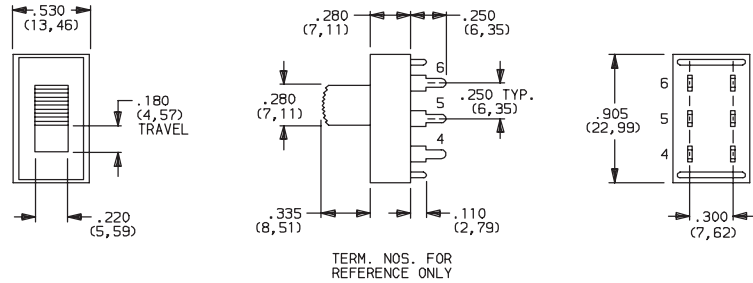

**AVAILABLE WITH:**  
Models: S101, S102, S112, S201, S202, S602  
Terminations: 02, 04 and 08  
Actuators: 03, 04, 09, 12\* and 13\*  
\*12 and 13 actuators available with S201, S202 and S602 models only.

**PC MOUNTING**  
For mounting information, see TERMINATIONS section, page I-31.

### S2 SNAP-IN PANEL



S802C21S207Q  
DPDT

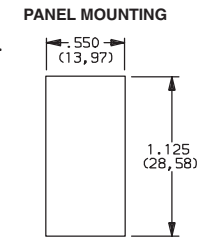
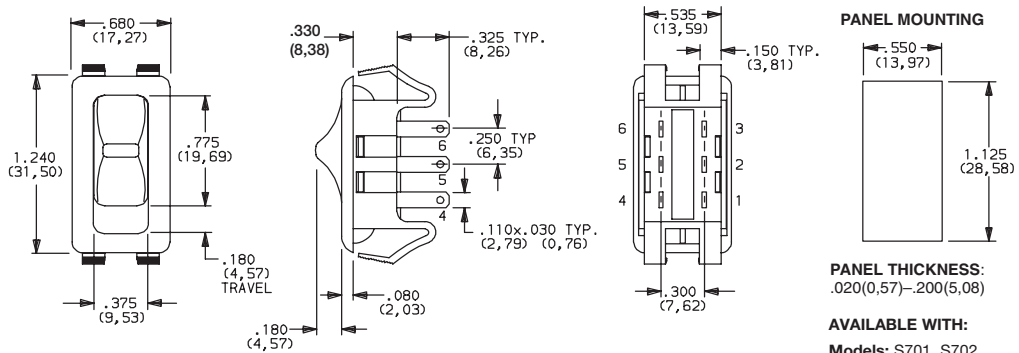

**PANEL THICKNESS:**  
.020(0,57)–.200(5,08)

**AVAILABLE WITH:**  
Models: S701, S702, and S802  
Terminations: 04, 07, 57 and WC  
Actuators: C2, C3, C5 and 03



Dimensions are shown: Inch (mm)  
Specifications and dimensions subject to change

# S Series Slide Switches

## MOUNTING STYLE

### TS PANEL WITH MOUNTING EARS

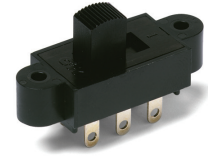
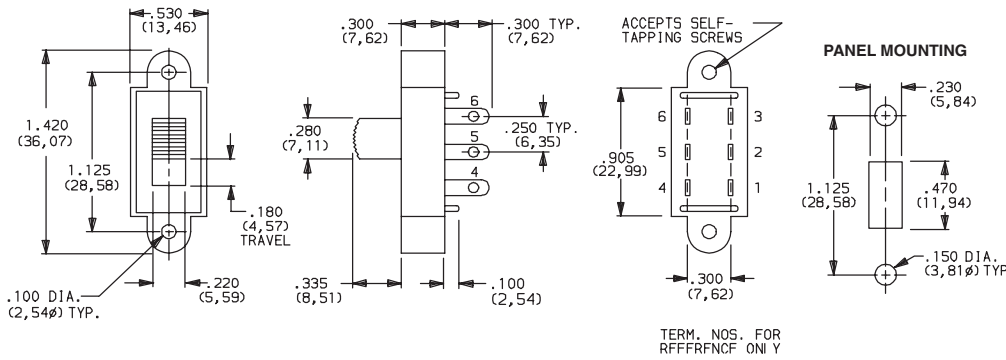

S202031TS03Q  
DPDT

AVAILABLE WITH:  
**Models:** S201, S202, and S602  
**Terminations:** All  
**Actuators:** 03, 04 and 12.

Slide

## TERMINATIONS

### 03 SOLDER LUG WITH HOLE

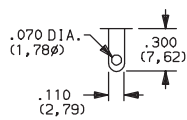

### 02 PC THRU-HOLE

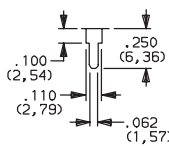

Recommended with 'MS' mounting style only.

### 04 PC THRU-HOLE

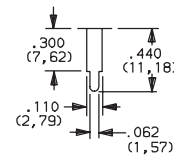

Recommended with double pole models only.

### 07 QUICK CONNECT

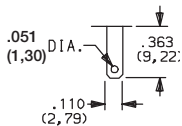

### 08 PC THRU-HOLE

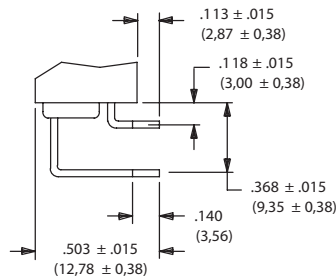

MS mounting style only.

### WC WIRE LEAD

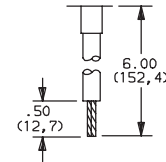

18 AWG wire for S1XX and S2XX models.  
 16 AWG wire for all other models. Black wire standard, other colors and lengths available, consult Customer Service Center.  
 UL style 1015.

### PC MOUNTING

02 & 04 terminations

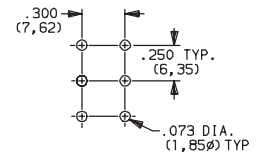

08 terminations with MS mounting style.

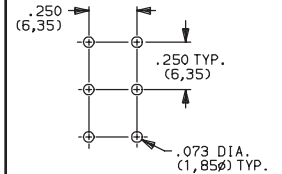

**NOTE:** All terminals on S1XX, S2XX and S6XX models are .020 (0,51) thick; all terminals on S7XX and S8XX models are .031 (0,79) thick.



Dimensions are shown: Inches (mm)  
 Specifications and dimensions subject to change

# S Series Slide Switches

## TOP PLATE MARKINGS

**NONE** NO MARKINGS

**D** ON-OFF

**L** ON

**M** ON-OFF

**N** RED RECTANGLE ON ONE END

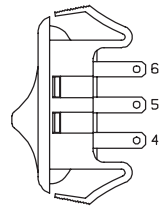
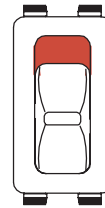
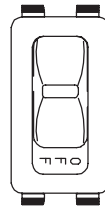
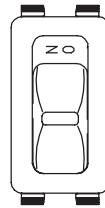
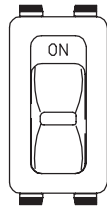
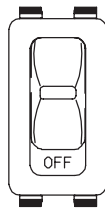
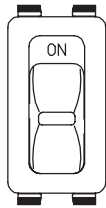
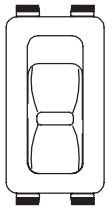

**NOTE:** Top plate markings are available with 'S2' mounting style only. The marking color on all top plates with marking options 'D, L and M' is white, standard. (except white top plates: marking color is black, standard). The marking color on all top plates with 'N' marking option is red, standard. Other marking colors are available, consult Customer Service Center.

**Note:** Orientation of actuator markings and terminals.

## CONTACT MATERIAL

OPTION CODE	CONTACT MATERIAL	RATINGS	
<b>Q</b>	SILVER <sup>2</sup>	POWER	S1XX, S2XX MODELS: 6 AMPS @ 125 V AC; 6 AMPS @ 250 V AC; 1 AMP @ 125 V DC  S6XX MODELS: 12 AMPS @ 125 V AC; 6 AMPS @ 250 V AC; 1 AMP @ 125 V DC  S7XX, S8XX MODELS: 15 AMPS @ 125 V AC; 6 AMPS @ 250 V AC
<b>B</b>	GOLD <sup>1</sup>	LOW LEVEL/DRY CIRCUIT	0.4 VA MAX. @20 V AC OR DC max.
<b>G</b>	GOLD OVER SILVER <sup>3</sup>	LOW LEVEL/DRY CIRCUIT OR POWER	S1XX, S2XX MODELS: 0.4 VA MAX. @ 20 V AC OR DC MAX. OR 6 AMPS @ 125 V AC; 6 AMPS @ 250 V AC; 1 AMP @ 125 V DC  S6XX MODELS: 0.4 VA MAX. @ 20 V AC OR DC MAX. OR 12 AMPS @ 125 V AC; 6 AMPS @ 250 V AC; 1 AMP @ 125 V DC  S7XX, S8XX MODELS: 0.4 VA MAX. @ 20 V AC OR DC MAX. OR 15 AMPS @ 125 V AC; 6 AMPS @ 250 V AC

\* Note: See Technical Data section of this catalog for RoHS compliant and compatible definitions and specifications.

<sup>1</sup> CONTACTS & TERMINALS: Copper, with gold plate over nickel plate.

<sup>2</sup> CONTACTS & TERMINALS: Copper, silver plated (standard with all termination options).

<sup>3</sup> CONTACTS & TERMINALS: Copper, with gold plate over nickel plate over silver plate.

**NOTE:** Any models supplied with Q, B or G contact material are RoHS compliant.

All models with all options when ordered with 'G' or 'Q' contact material.

NOTE: 'G' contact material is equivalent to both 'B' and 'Q' contact materials.

## SEAL

**NONE** NO SEAL

**E** EPOXY SEAL

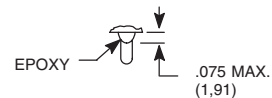

## AVAILABLE HARDWARE

Cap, C2; C3 actuators

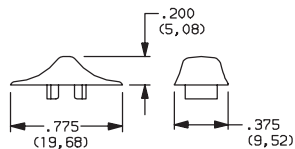

**PART NO.**  
**121160100** WHITE  
**121160200** BLACK  
**121160300** RED

Material: 6/6 Nylon  
 Finish: Matte

Cap, 03 actuator

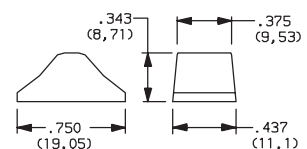

**PART NO.**  
**121000101** WHITE  
**121000102** BLACK  
**121000103** RED

Material: 6/6 Nylon  
 Finish: Gloss

**NOTE:** Other cap colors available, consult Customer Service Center.



Third Angle Projection  
 Dimensions are shown: Inch (mm)  
 Specifications and dimensions subject to change

