

SDS Series Side Actuated Detect Switches

Features/Benefits

- Low profile package sits just 2mm off PCB
- 2mm overtravel ideal for detector applications
- Low actuation force (75 grams max.)
- Pick & place compatible, available in tape & reel packaging
- RoHS compliant and compatible

Typical Applications

- Medical devices
- Consumer electronics
- PCB lock cam detect
- IoT devices
- ATCA and MicroTCA



Specifications

CONTACT RATING: 100 mA @ 12 VDC.
 MECHANICAL & ELECTRICAL LIFE: 50,000 cycles.
 CONTACT RESISTANCE: 100 m Ω max. initial.
 INSULATION RESISTANCE: 10 M Ω min. @ 100 VDC.
 OPERATING TEMPERATURE: -40°C to +85°C.
 SOLDERABILITY: IR compatible, no wash. 260°C max.
 PACKAGING: Bulk or tape & reel (3000 per reel).

Materials

BASE: Glass filled LCP (UL 94V-0).
 ACTUATOR: Glass Filled LCP (UL94V-0).
 COVER: Nickel silver w/silver plate.
 MOVABLE CONTACT: Phosphor bronze, see table for plating.
 TERMINALS: Phosphor bronze, see table for plating.

NOTE: Specifications and materials listed above are for switches with standard options. For information on specific and custom switches, consult Customer Service Center.

How To Order

Our easy build-a-switch concept allows you to mix and match options to create the switch you need. To order, select desired option from each category and place it in the appropriate box.

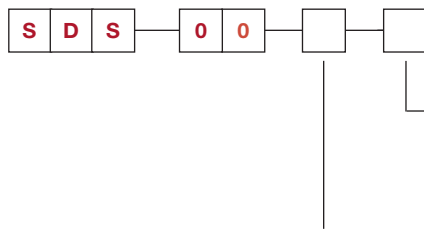

Packaging
NONE Bulk
R Tape & Reel

- 1** Normally open silver plating
- 2** Normally close silver plating
- 4** Normally open gold plating
- 5** Normally close gold plating



m

Detect



Third Angle Projection

Dimensions are shown: mm
 Specifications and dimensions subject to change

SDS Series Side Actuated Detect Switches

Complete part numbers for SDS Series Switches are shown below.

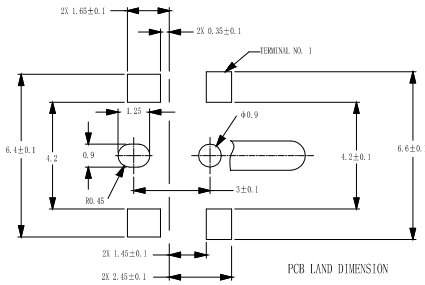
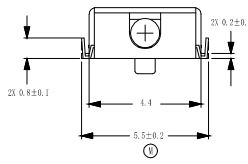
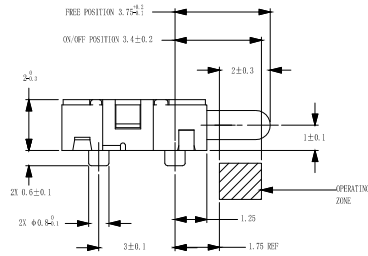
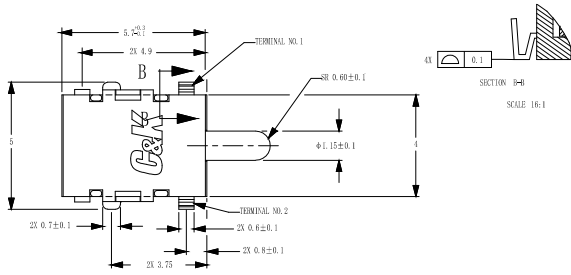

PART NUMBER	HOUSING COLOR	PACKAGING	SCHEMATIC	Contact Plating	Terminal Plating
SDS001	Black	Bulk		Silver Clad	Silver Plate
SDS001R		Tape & Reel			
SDS002	White	Bulk		Gold Flash	Gold Flash
SDS002R		Tape & Reel			
SDS004	Black	Bulk		Gold Flash	Gold Flash
SDS004R		Tape & Reel			
SDS005	White	Bulk		Gold Flash	Gold Flash
SDS005R		Tape & Reel			



SDS001
SPST

TAPE & REEL

TAPE & REEL PACKAGING NOTES:

- PACKAGE QUANTITY: 3,000 PCS/REEL.
- SPECIFICATION OF TAPING PACKAGE: THE REEL CARRIER TAPE WILL HAVE A LEAD OF 33 EMPTY COMPONENT POCKETS AND AN END OF 14 EMPTY COMPONENT POCKETS ON EVERY REEL. ALL EMPTY COMPONENT POCKETS WILL BE SEALED WITH COVER TAPE.
- AFTER THE LEAD, NO REEL CARRIER TAPE SHALL HAVE TWO CONSECUTIVE EMPTY COMPONENT POCKETS.

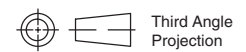
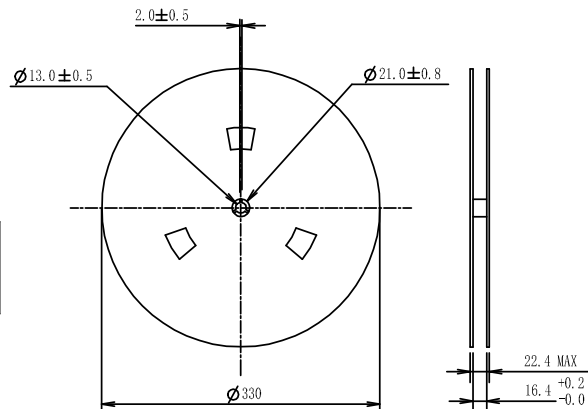
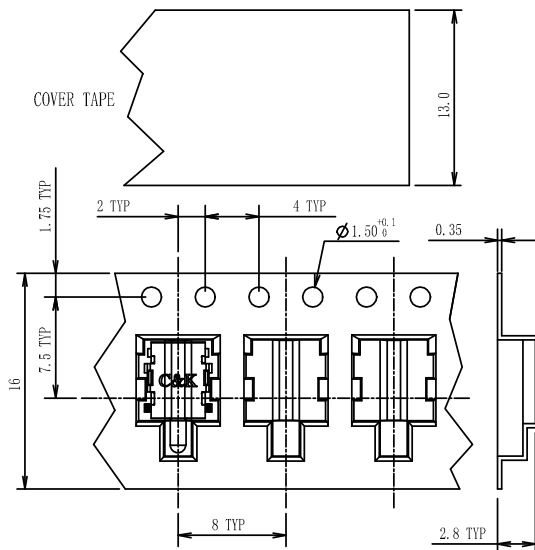

Third Angle Projection
Dimensions are shown: mm
Specifications and dimensions subject to change