

Monteringsanvisning | Montageanleitung | Mounting instruction | Installationsanvisningar | Instructions de montage | Montage-instructies | Item N°: 2015700001
Operating frequency range(s) : 2400 – 2483.5 MHz
Maximum RF output power: <10dBm

packing list

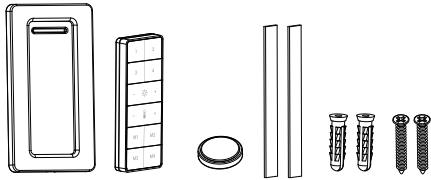

Tools list

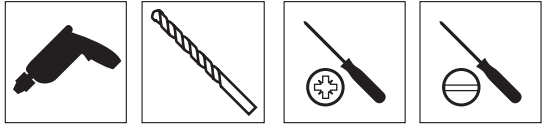

a

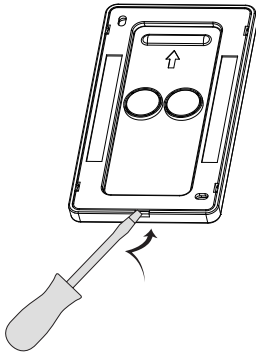

1

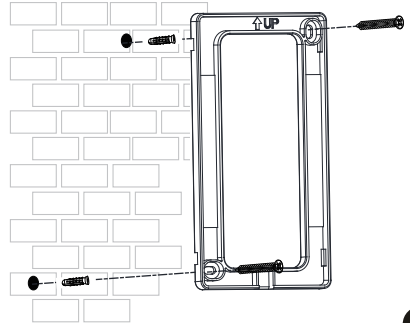

2

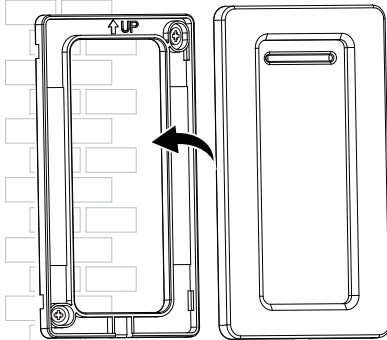

3

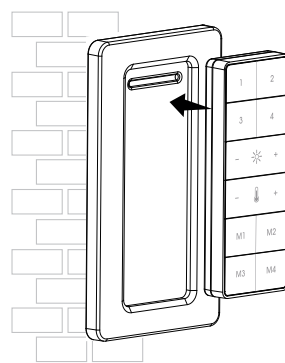

4

b

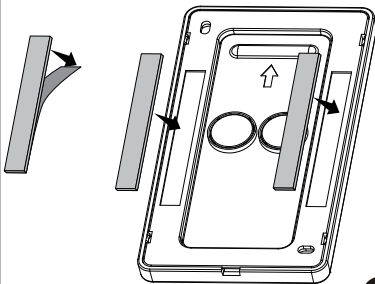

1

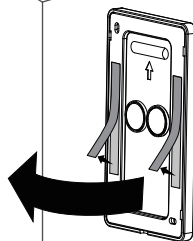

2

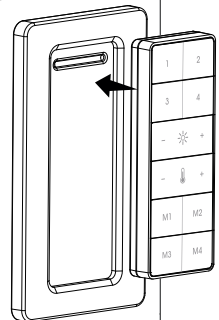

3

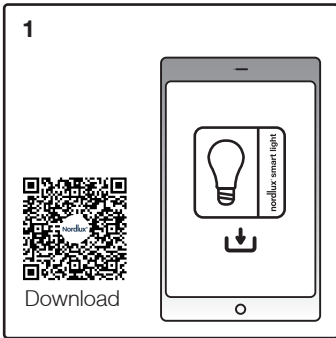

Download Nordlux Smart Light in Apple App Store or Google Play.

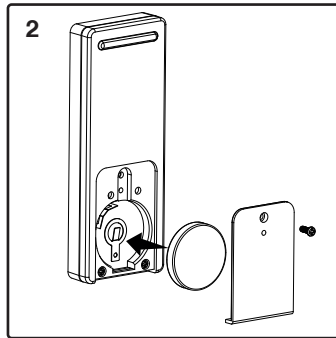

Mount the button battery.

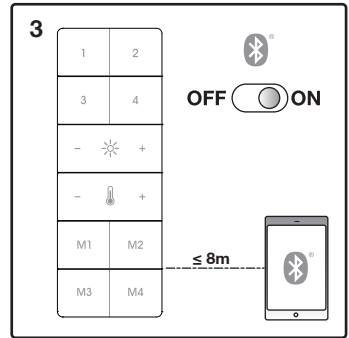

Turn on the Bluetooth of your phone. Stay within 8 meters from the remote control.

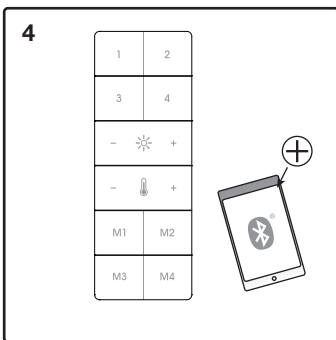

Open Nordlux Smart Light App and connect the remote control via "+" in App.

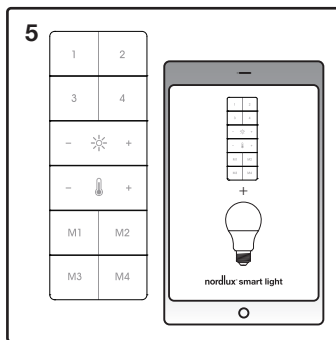

Select the Groups of bulbs and luminaires to be controlled by the remote control.

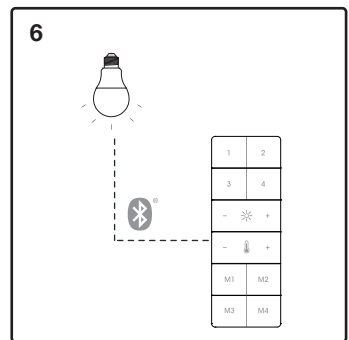

Control the lights via the remote control.



Waste electrical products should not be disposed of with household waste. Please recycle where facilities exist. Check with your Local Authority or local store for recycling advice.



Conformity with all relevant EC Directive requirements.



Do not ingest battery, Chemical Burn Hazard

This product contains a coin / button cell battery. If the coin / button cell battery is swallowed, it can cause severe internal burns in just 2 hours and can lead to death.

Keep new and used batteries away from children.

If the battery compartment does not close securely, stop using the product and keep it away from children.

If you think batteries might have been swallowed or placed inside any part of the body, seek immediate medical attention.

Replacement of a battery with an incorrect type that can defeat a safeguard;

Disposal of a battery into fire or a hot oven, or mechanically crushing or cutting of a battery, that can result in an explosion;

Leaving a battery in an extremely high temperature surrounding environment that can result in an explosion or the leakage of flammable liquid or gas;

And a battery subjected to extremely low air pressure that may result in an explosion or the leakage of flammable liquid or gas.

START SMART

nordlux®