

Smart Home



DE

Urheberrechtlich geschützt, 2018, Alfred Schellenberg GmbH. Alle Rechte vorbehalten. Jede vom Urheberrechtsgesetz nicht zugelassene Verwertung, insbesondere Vervielfältigung, Übersetzung, Verarbeitung bzw. Weitergabe von Inhalten in Datenbanken oder anderen elektronischen Medien und Systemen, ist verboten.

GB

Copyright protected, 2018 Alfred Schellenberg GmbH. All rights reserved. Any use, in particular reproduction, translation, processing or transmission of content into databases or other electronic media and systems beyond the authorization provided by the copyright legislation is strictly prohibited.

FR

Soumis au droit d'auteur, 2018, Alfred Schellenberg GmbH. Tous droits réservés. Interdiction de toute utilisation non autorisée par le droit d'auteur, et notamment de la reproduction, de la traduction, de la transformation ou de la transmission des contenus des bases de données ou des autres médias et systèmes électroniques.

PL

Chronione prawami autorskimi, 2018, Alfred Schellenberg GmbH. Zabronione jest wszelkie wykorzystanie niezgodne z Ustawą o prawie autorskim, w szczególności powielanie, tłumaczenie, przetwarzanie lub przekazywanie treści w bazach danych lub na/w innych nośnikach i systemach elektronicznych.

IT

Protetto da copyright, 2018, Alfred Schellenberg GmbH. Tutti i diritti riservati. È vietato qualsiasi tipo di utilizzo diverso da quello previsto dai diritti d'autore, in particolare la copia, la traduzione, l'elaborazione o la trasmissione dei contenuti in database o altri strumenti elettronici e sistemi.

INHALTSVERZEICHNIS

Sicherheit und Hinweise	4
Technische Daten	8
Produktabbildung/Tastenerklärung/Display	8
Kopplung mit Smart Home-System	10
Benötigte Werkzeuge	44
Lieferumfang	44
A Montage	45
B Rohrmotor: Adresse zuweisen	51
C Programmiermodus starten	53
D Kanalwahl	54
E Funk-Zeitschaltuhr PREMIUM koppeln	55
F Drehrichtung prüfen	57
G Drehrichtung ändern	58
H Endlage Auffahrt einstellen	59
I Endlage Abfahrt einstellen	61
J Programmiermodus beenden	63
K Zwischenlage setzen (optional)	64
L Zwischenlage löschen	66
M Zwischenlage anfahren	68
N Endlage anfahren	69
O Weitere Funk-Sender koppeln	70
P Gekoppelte Funk-Zeitschaltuhr PREMIUM löschen	74
Q Werkseinstellung (Rohrmotor)	78
R Einstellung Uhrzeit und Datum	83
S Manuell- und Automatikumschaltung	86
T Tages- und Wochenprogrammumschaltung	86
U Urlaubsfunktion / Zufallsfunktion	87
V Astrofunktion	87
W Tagesprogramm einstellen	88
X Wochenprogramm einstellen	91
Y Programmierung der Astrofunktion	94
Z Werkseinstellung (Funk-Zeitschaltuhr PREMIUM)	97

SICHERHEIT UND HINWEISE

Sehr geehrte Kundin, sehr geehrter Kunde,



bitte lesen Sie vor der Montage und Inbetriebnahme diese Anleitung vollständig durch. Beachten Sie alle Sicherheitshinweise, bevor Sie mit den Arbeiten beginnen.

Bewahren Sie die Anleitung auf und weisen Sie jeden Benutzer auf eventuelle Gefahren hin, die im Zusammenhang mit diesem Produkt stehen. Übergeben Sie die Anleitung bei einem Besitzerwechsel auch dem Nachbesitzer. Bei Schäden, die durch unsachgemäßen Gebrauch oder durch fehlerhafte Montage entstehen, erlischt jeder Gewährleistungsanspruch.

SICHERHEITSHINWEISE



Es besteht Verletzungsgefahr durch Stromschlag. Vor Arbeiten an elektrischen Anlagen müssen diese spannungsfrei geschaltet werden.

- Das Produkt nur in trockenen Räumen verwenden (IP 20).
- Elektroanschlüsse dürfen nur durch eine autorisierte Fachkraft ausgeführt werden.
- Die funkbetriebene Rollladen- /Markisenanlage muss während des Betriebs einsehbar sein, insbesondere wenn die Rollladen- /Markisenanlage durch mehr als einen Funk-Sender angesteuert wird.
- Halten Sie Personen aus dem Fahrbereich der Rollladen- /Markisenanlage fern. Es besteht Verletzungsgefahr.
- Das Produkt ist kein Spielzeug, halten Sie Kinder davon fern.
- Es besteht Verletzungs- und Erstickungsgefahr durch Kleinteile des Produktes und der Verpackung.
- Für den Betrieb einer Rollladen- /Markisenanlage über das Produkt müssen die landesspezifischen Bestimmungen beachtet werden.

- Batterien nur durch den gleichen Typ ersetzen, LR03/AAA (2x).
- Den Rohrmotor/Antrieb nicht über die Endlagen hinaus fahren. Beschädigungsgefahr!
- Bei Reparatur oder Fragen rund um den Austausch und die Montage eines unserer Produkte wenden Sie sich bitte an unseren Kunden- bzw. unseren Montageservice (0271 89056-444).

BESTIMMUNGSGEMÄSSE VERWENDUNG

- Das Produkt (Art. Nr. 20032/20037) ist ausschließlich für die dafür freigegebenen Funkprodukte der Firma Alfred Schellenberg GmbH ausgelegt.
- Die Rollladen- oder Markisenanlage und deren Teile müssen in einem einwandfreien Zustand sein. Mängel an der Anlage oder deren Teilen müssen vor dem Einbau des Produkts behoben werden.
- Eine andere oder darüber hinausgehende Verwendung gilt als nicht bestimmungsgemäß.
- Für Personenschäden, Sachschäden und Folgeschäden bei nicht bestimmungsgemäßer Verwendung haftet die Alfred Schellenberg GmbH nicht.
- Der Betrieb von Funkanlagen in der Nähe von Geräten mit magnetischer Strahlung oder metallischen Flächen beeinträchtigt die störungsfreie Funktion.
- Bauliche Gegebenheiten beeinträchtigen die Reichweite und Funktion der Funkanlage.
- Die Funkanlage darf nicht in Bereichen mit hohem Risiko der Störung Dritter (z.B. Krankenhäuser, Flughäfen oder ähnlichen Einrichtungen) betrieben werden.
- Es besteht kein Schutz vor Störungen durch andere ordnungsgemäß aufgebaute und betriebene Funkanlagen. Insbesondere durch ordnungsgemäße Anlagen, die im gleichen Frequenzbereich arbeiten.

- Das Produkt nur mit Verbrauchern betreiben, die bei einer Funktionsstörung der Sender oder Empfänger keine Gefahr für Personen oder Sachen darstellt.
- Für Personenschäden, Sachschäden und Folgeschäden bei nicht bestimmungsgemäßer Verwendung haftet die Alfred Schellenberg GmbH nicht. Nicht sachgemäße Verwendung:
 - Fehlerhafter Einbau des Produkts.
 - Eine Nichtbeachtung der Bedienungs- und Einbauanleitung.
 - Unsachgemäße Bedienung, Verwendung oder Beanspruchung.
 - Äußere Einwirkungen, die zur Beschädigung des Produktes führen (z.B. Stöße, Schläge).
 - Reparaturen und Veränderungen durch Dritte.
 - Verwendung von ungeeignetem Zubehör.
 - Schäden durch Überspannung, wie z.B. Blitzschlag.
 - Funktionsstörung durch Überlagerung der Funkfrequenz und andere Funkstörung.
- Das Produkt ist ausgelegt zur Funkbedienung von nachfolgend aufgelisteten Produkten der Alfred Schellenberg GmbH.



PRODUKT	ART.-NR.
Funk-Rohrmotor PREMIUM	20506, 20510, 20810, 20820, 20840, 20507, 20511, 20811, 20821, 20841
Funk-Rollladengurt-Antrieb ROLLODRIVE 65 PREMIUM	22767, 22728
Funk-Rollladengurt-Antrieb ROLLODRIVE 75 PREMIUM	22576, 22578
Funk-Schalter	20030, 20035
Funk-Empfangsmodul	20017, 20018
Funk-Steckdose	20033, 20034, 20038, 20039

PRODUKT	ART.-NR.
Funk-Lichtschalter	21002, 21004
Funk-Lichtmodul	21003, 21005
Funk-Markisenantrieb PREMIUM	20264, 20263
Funk-Markisenmotor PREMIUM	20281, 20282



Die Funktionalität ist abhängig vom jeweiligen Produkt. Eine genaue Beschreibung finden Sie in der Anleitung der Produkte.

EU-KONFORMITÄTSERKLÄRUNG

Die Funk-Zeitschaltuhr PREMIUM (Art. Nr.  20032,  20037) erfüllt die geltenden Anforderungen der europäischen und nationalen Richtlinien. Die Konformität wurde nachgewiesen. Der vollständige Text der EU-Konformitätserklärung ist unter der folgenden Internetadresse verfügbar:
<http://www.schellenberg.de> (Menüpunkt „Service“ im Download-Center)



Funkanlagenrichtlinie 2014/53/EU (RED)
RoHS-Richtlinie 2011/65/EU



Nicht im Hausmüll entsorgen! Das Produkt ist recyclingfähig und kann im Wertstoffhof oder an einer anderen Sammelstelle für elektrischen Hausmüll abgegeben werden.

Akkus/Batterien: Werfen Sie Akkus oder Batterien nicht in den Hausmüll, ins Feuer oder ins Wasser. Akkus und Batterien sollen gesammelt, recycelt oder auf umweltfreundliche Weise entsorgt werden.

TECHNISCHE DATEN

Sendefrequenz	868,4 MHz Schellenberg Radio System
Sendeleistung	max. 10dBm / 10 mW
Reichweite Freifeld	max. 100 Meter
Reichweite im Gebäude	max. 20 Meter
Spannungsversorgung	3,0 Volt DC
Batterietyp	2x 1,5 V Typ AAA
Schutzart	IP 20, nur für trockene Innenräume
Umgebungstemperatur	0° – 50° Celsius
Receiverkategorie	3



Achtung: Die Funkreichweite kann von baulichen Gegebenheiten beeinflusst werden. Platzieren Sie das Produkt bitte nicht in die Nähe von Störquellen wie große metallische Gegenstände, Elektrogeräte mit Metallgehäuse o.ä.

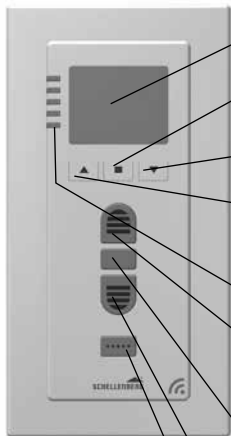

- ① **Display**
- ② **Menütaste Set**
Bestätigt
Menüeinstellungen
- ③ **Menütaste Minus**
Menüeinstellungen
- ④ **Menütaste Plus**
Menüeinstellungen

Zeitschaltuhr - Funktion

- ⑤ **LED Kanal 1-5**
- ⑥ **Taste Auffahrt**
Rollladen/Markise fährt nach oben/aus. Funk-Steckdose/ Funk-Lichtmodul/Funk-Lichtschalter schaltet an
- ⑦ **Taste Stopp**
Rollladen/Markise stoppt. Funk-Steckdose/Funk-Lichtmodul/Funk-Lichtschalter schaltet aus

Handsender - Funktion

- ⑧ **Taste Abfahrt**
Rollladen/Markise fährt nach unten/ein. Funk-Steckdose/ Funk-Lichtmodul/Funk-Lichtschalter schaltet aus
- ⑨ **Taste Kanalwahl**
Zum Anwählen eines bestimmten Kanals

Beschreibung LEDs

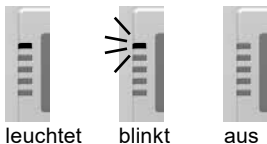

Beschreibung Display

⑩ **Channel** Zeigt den aktuellen Kanal an. Kanäle mit Kreis umrandet sind programmierte Kanäle.

⑪ **Wochentag** Zeigt den aktuellen Wochentag an.
1 = Mo, 2 = Di, 3 = Mi,
4 = Do, 5 = Fr, 6 = Sa,
7 = So

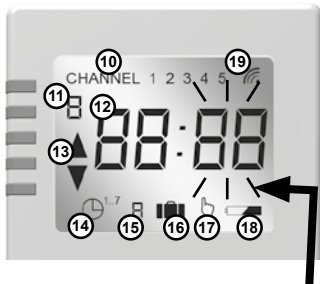

Anzeige blinkt

⑫ **Uhrzeit** Zeigt die eingestellte Uhrzeit an.

⑬ **Auf- und Abfahrt / An und Aus**
Rollladen-/ Markisenfahrtrichtung oder Status Funk-Steckdose, Funk-Lichtmodul, Funk-Lichtschalter wird angezeigt.

⑭ **Tages- und Wochenprogramm**

 = Tagesprogramm = Einstellung der Auf- und Abfahrzeit für alle Wochentage.

 = Wochenprogramm = Individuelle Einstellung der Auf- und Abfahrzeit für jeden Wochentag.

⑮ **Astrofunktion** Die Abendschließung erfolgt nach Sonnenuntergang im Jahresverlauf.

⑯ **Urlaubs- und Zufallsfunktion** Zuschaltbar zum Tages-Wochenprogramm. Verändert die programmierten Zeiten zufällig um bis zu +/- 15 Minuten.

⑰ **Manuelle Bedienung (Aussperrschutz)** Der Rollladen lässt sich manuell auf- und abfahren. Deaktiviert den Automatikbetrieb und schützt vor ungewolltem Aussperren.

⑱ **Batterie-Anzeige** Erscheint bei schwachem Batteriestand.

KOPPLUNG SMART HOME-SYSTEM

Koppeln Sie das Produkt mit dem Schellenberg Smart Home-System oder dem Smart Friends System und benutzen Sie alle Schellenberg Funk-Produkte bzw. „Ready für Smart Friends“-Produkte über eine App miteinander.

SCHELLENBERG SMART HOME SYSTEM



Art.Nr. 21000



www.schellenberg.de/SH1/

SMART FRIENDS SYSTEM



Art.Nr. 26000

ABUS
Paulmann
Schellenberg
Steinel



www.smart-friends.com

TABLE OF CONTENTS

Safety and notices	13
Technical data	16
Product image / button description / display	17
Pairing with smart home system	19
Required tools	44
Scope of delivery	44
A Installation	45
B Tubular motor: Address assignment	51
C Programming mode start	53
D Channel selection	54
E Wireless timer PREMIUM pairing	55
F Tubular motor rotation check	57
G Tubular motor direction change	58
H Setting the upper end position	59
I Setting the lower end position	61
J Concluding the programming mode	63
K Intermediate position setting (optional)	64
L Intermediate position deletion	66
M Intermediate position approach	68
N End position approach	69
O Pairing of further wireless timers PREMIUM	70
P Unpairing of a previously paired wireless timer PREMIUM	74
Q Factory default reset (tubular motor)	78
R Setting of the time and date	83
S Manual and automatic switching	86
T Day and week programme change	86
U Holiday function (random function)	87
V Astro function	87
W Daily program setting	88
X Weekly program setting	91
Y Programming of the astro function / summer - winter time ..	94
Z Factory default reset (wireless timer PREMIUM)	97

SAFETY AND NOTICES

GB

Dear customers,



Please completely read this instruction manual before the installation and commissioning. Observe all safety instructions before you begin to work. Keep the instruction manual stored at hand and advise each user about possible dangers that are related to this product. When ownership to this product changes, hand this instruction manual over to the new owner. In case of damages which are caused by misuse or improper installation any legal warranty claim will be void.

SAFETY INSTRUCTIONS



There is danger to life from electric shock!
Before working on electrical equipment, it must be completely de-energized.

- Take safety measures against the accidental subsequent on-switching of the power.
- This also applies for the maintenance and repair of electric roller shutter systems.
- Electrical connections may only be performed by authorized, qualified electricians.
- Improper installation can result in serious injuries or property damage.
- The provisions of the local electric utility company as well as all applicable standards and regulations for electrical installations must be complied with.

- The product may only be used in dry rooms (IP20).
- The product and the packaging are not toys. Keep children away from it, since there is a risk of injury or suffocation.
- Do not open the product, risk of injury.
- Keep people away from the movement range of the roller shutter system. The movement range of the roller shutter system must be completely visually accessible during the operation.
Risk of injury.

INTENDED USE



- The product (Item No. 20032/20037) is exclusively designed for the respectively approved wireless products of the Alfred Schellenberg GmbH.
- The roller shutter or awning system and its components must be in a perfect condition. Defects in the system or its parts must be repaired before installing the radio reception module.
- Any other or further utilization beyond the explicitly specified shall be regarded as not intended use.
- Alfred Schellenberg GmbH shall not be liable for any consequential damage, property damage and personal injury due to improper use.
- The operation of the hand-held wireless remote control in the vicinity of equipment that emits electromagnetic radiation or has metal surfaces can affect the correct operation.
- The structural conditions affect the range and function of the radio equipment.
- The radio equipment may not be operated in areas with high risk or if third parties are disturbed (for example, hospitals, airports and similar facilities).
- There is no protection from interference from other properly constructed or operated radio equipment. Particularly from properly operating systems that utilize the same frequency range.

- Please keep these instructions stored in a safe place, as they must be available to every user.
- The product is designed for the wireless control of wireless drives, Wireless reception modules and wireless reception switches from Alfred Schellenberg GmbH.

PRODUCT	ITEM NO.
Wireless tubular motor PREMIUM	20506, 20510, 20810, 20820, 20840, 20507, 20511, 20811, 20821, 20841
Wireless shutter belt drive ROLLODRIVE 65 PREMIUM	22767, 22728
Wireless shutter belt drive ROLLODRIVE 75 PREMIUM	22576, 22578
wireless reception switch	20030, 20035
radio reception module	20017, 20018
Wireless socket	20033, 20034, 20038, 20039
Wireless light switch	21002, 21004
Wireless Light Module	21003, 21005
Marki Drive PLUS	20268, 20269

The functionality is dependent on the respective product. A detailed description can be found in the manual of the products.

CE DECLARATION AND CONFORMITY

The Wireless timer PREMIUM (Art. Nr.  20032,  20037) meets the applicable requirements of European and national regulations. Conformity has been demonstrated. The full EU Declaration of Conformity document can be found at: <http://www.schellenberg.de> (under 'Download-Center', in the 'Service' tab).

 Radio Equipment Directive 2014/53/EU (RED)
RoHS Directive 2011/65/EU



Do not dispose of together with household waste.
The product is recyclable and can be deposited at a recycling center or a collection station for electrical household garbage.

TECHNICAL DATA

Transmission frequency	868,4 MHz Schellenberg
Signal strength	max. 10 dBm/10 mW
Range in the open field	up to 150 meters
Range within buildings	up to 20 meters
Power supply	2,4 – 3,0 Volt DC
Battery type	2x 1,5 V Typ AAA
Protection class	IP 20
Ambient temperature	0° – 50° Celsius
Receiver category	3



The structural conditions affect the range and function of the wireless timer.

PRODUCT IMAGE / BUTTON DESCRIPTION / DISPLAY

GB

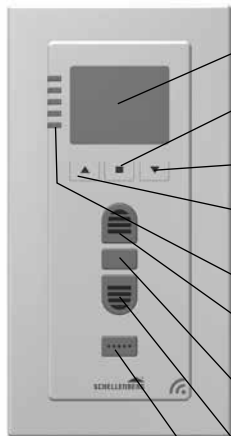

- ① **Display**
- ② **Menu button set**
confirms menu settings
- ③ **Menu button minus**
menu settings
- ④ **Menu button plus**
menu settings

- ⑤ **LED channel 1-5**
- ⑥ **Open button**
roller shutter moves up or stops
- ⑦ **stop button**
the roller shutter will stop
- ⑧ **Close button**
roller shutter moves up or stops
- ⑨ **channel selection button**
to select a specific channel

Time switch - function

Hand-held transmitter - function

Description LEDs

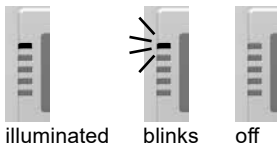

Description Display

⑩ **Channel** Displays the current channel. Channels with a circle are programmed channels.

⑪ **Weekday** Shows the current day of the week.
 1 = Mon, 2 = Tue, 3 = Wed,
 4 = Thu, 5 = Fri, 6 = Sat,
 7 = Sun

⑫ **Time** displays the set time.

⑬ **Automatic lowering and raising time**
 the roller shutter drive direction is displayed.

⑭ **Daily and weekly programme: daily program**

 = daily program = setting of the lowering and raising times for all days of the week.

 = Weekly program = individual adjustment of the lowering and raising time for each day of the week.

⑮ **Astro function** the evening closing takes place after sunset throughout the year.

⑯ **Vacation and random function** can be added to the daily or weekly program. Changes the programmed times randomly by up to +/- 15 minutes.

⑰ **Manual operation (lock-out protection)** Der Rollladen lässt sich manuell auf- und abfahren.
 the roller shutter can be manually lowered and raised. Disables the automatic operation and protects against an unintentional lock-out

⑱ **Battery display** is displayed if the battery level is low.

⑲ **Wireless simple** only appears for bi-directional wireless.

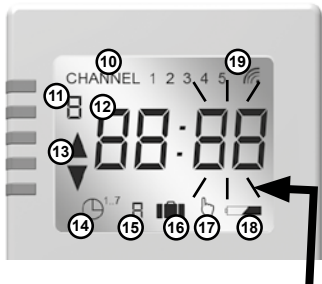

Display blinks

PAIRING WITH SMART HOME SYSTEM

GB

Pair the product with the Smart Friends System, and control all „Ready for Smart Friends“ products through the Smart Friends app.

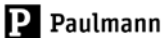

www.smart-friends.com

TABLE DES MATIÈRES

Sécurité et consignes	21
Caractéristiques techniques	24
Illustration du produit / explication des touches / affichage	25
Couplage Avec Le système smart home	27
Outils nécessaires	44
Étendue de livraison	44
A Montage	45
B Moteur tubulaire : Assigner une adresse	51
C Démarrer le mode de programmation	53
D Sélection du canal	54
E Couplage de la minuterie radioélectrique PREMIUM	55
F Contrôler le sens de rotation du moteur tubulaire	57
G Modifier le sens de rotation	58
H Régler le point d'extrémité supérieur	59
I Régler le point d'extrémité inférieur	61
J Quitter le mode de programmation	63
K Régler le point intermédiaire (en option)	64
L Effacer le point intermédiaire	66
M S'approcher du point intermédiaire	68
N S'approcher du point d'extrémité	69
O Couplage d'autres minuteries radioélectriques PREMIUM	70
P Déconnecter une minuterie radioélectrique PREMIUM couplée	74
Q Réinitialisation des réglages usine (moteur tubulaire)	78
R Réglage de l'heure et de la date	83
S Commutation entre le mode manuel et le mode automatique	86
T Commutation entre le programme journalier et le programme hebdomadaire	86
U Fonction vacances (fonction aléatoire)	87
V Astro fonction	87
W Réglage du programme journalier	88
X Réglage du programme hebdomadaire	91
Y Programmation de la fonction Astro	94
Z Réinitialisation des réglages usine (minuterie radioélectrique PREMIUM)	97

SÉCURITÉ ET CONSIGNES

Chers clients, chères clientes,



Veuillez lire cette notice complètement avant le montage et la mise en service. Respectez toutes les consignes de sécurité avant de commencer les travaux. Conservez cette notice et indiquez à chaque utilisateur les éventuels dangers en liaison avec ce produit. En cas de changement de propriétaire, transmettez cette notice également au nouveau propriétaire. Pour les dommages, résultant d'une utilisation non conforme ou d'un montage incorrect, la prétention de garantie serait alors annulée.

FR

CONSIGNES DE SÉCURITÉ



Danger de mort à cause d'une décharge électrique !
Avant de travailler sur les installations électriques, ces dernières doivent être mises hors tension.

- Prenez des mesures de sécurité pour empêcher une mise sous tension involontaire.
- Ceci s'applique également aux travaux de maintenance et de réparation sur les volets roulants électriques.
- Les raccordements électriques doivent toujours être réalisés par un technicien qualifié agréé et autorisé.
- Une installation incorrecte risque d'entraîner de graves blessures corporelles ou des dommages matériels.
- Il convient de respecter les réglementations de l'entreprise d'approvisionnement en électricité locale ainsi que toutes les normes et réglementations en vigueur relatives aux installations électriques.

- Utiliser le produit uniquement dans des locaux secs (classe de protection IP20).
- Le produit et l'emballage ne sont pas des jouets. Tenez les enfants éloignés, un risque de blessure ou d'asphyxie existe.
- Ne pas ouvrir le produit, risque de blessure.
- Maintenez à distance les personnes du champ d'action du volet roulant. Le champ d'action des volets roulants doit être visible pendant le fonctionnement. Un risque de blessure existe.

UTILISATION CONFORME

- Le produit (Réf. 20032/20037) est homologué exclusivement pour commander les produits radioélectriques de la société Alfred Schellenberg GmbH.
- Les volets roulants ou les stores roulants et leurs composants doivent être intacts. Tout défaut sur l'installation ou ses composants doit être éliminé avant de monter le module de radioreception.
- Toute autre utilisation ou utilisation dépassant ce cadre est considérée comme non conforme.
- L'entreprise Alfred Schellenberg GmbH ne garantit pas les dommages matériels, corporels et consécutifs résultant d'une utilisation non conforme.
- Le fonctionnement du radioémetteur portable à proximité d'appareils à rayonnement électromagnétique ou à proximité de surfaces métalliques peut être entravé par des perturbations.
- Les bâtiments autour du site d'utilisation influencent la portée et le fonctionnement de l'installation radioélectrique.
- L'installation radioélectrique ne doit pas être utilisée dans des zones où elle risque d'entraver de tierces personnes (dans des hôpitaux, aéroports ou autres établissements).
- D'autres installations radioélectriques édifiées et exploitées dans les normes n'y procurent aucune protection contre les

perturbations. Cela s'applique en particulier aux installations conformes travaillant dans la même bande de fréquences.



- Veuillez conserver cette notice, elle doit être à disposition de tous les utilisateurs.
- Le produit est conçu pour commander à distance les entraînements radio, les modules de réception radio et les interrupteurs-récepteurs radio de la société Alfred Schellenberg GmbH.



PRODUIT	ART.-NO.
Moteur tubulaire radio PREMIUM	20506, 20510, 20810, 20820, 20840, 20507, 20511, 20811, 20821, 20841
Motorisation radio de la sangle du volet roulant ROLLODRIVE 65 PREMIUM	22767, 22728
Motorisation radio de la sangle du volet roulant ROLLODRIVE 75 PREMIUM	22576, 22578
Interrupteur-récepteur radio-électrique	20030, 20035
module de radioréception	20017, 20018
Prise CPL	20033, 20034, 20038, 20039
Interrupteur radio	21002, 21004
Module d'éclairage radio	21003, 21005
Marki Drive PLUS	20268, 20269

La fonctionnalité dépend du produit en question. Vous trouverez une description détaillée dans les notices d'utilisation des produits.

DÉCLARATION DE CONFORMITÉ UE

La minuterie radioélectrique PREMIUM (Art. Nr.  20032,  20037) est conforme aux exigences applicables des directives nationales et européennes. La conformité a été prouvée. Le texte complet de la déclaration de conformité UE est disponible à l'adresse suivante : <http://www.schellenberg.de> (élément de menu « Service » dans la plateforme de téléchargement).



Radio Equipment Directive 2014/53/EU (RED)
RoHS Directive 2011/65/EU



Non smaltire insieme ai rifiuti domestici! Il prodotto è riciclabile e può essere consegnato presso un centro di raccolta specializzato per rifiuti elettrici.



CARACTÉRISTIQUES TECHNIQUES

Fréquence de transmission	868,4 MHz Schellenberg
Puissance d'émission	max. 10 dBm / 10 mW
Portée sur terrain	jusqu'à 150 mètres
Portée un bâtiment	jusqu'à 20 mètres
Alimentation en tension	2,4 – 3,0 Volt DC
Type de batterie	2x 1,5 V Typ AAA
Type de protection	IP 20
Température ambiante	0° – 50° Celsius
Catégorie de récepteur	3



Les bâtiments autour du site d'utilisation sont susceptibles d'influencer la portée et le fonctionnement de la minuterie radioélectrique.

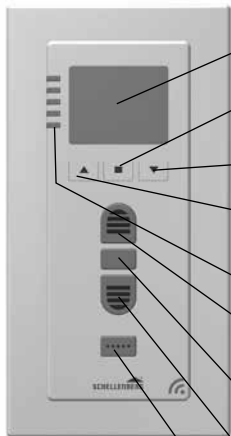

- ① **Affichage**
- ② **Touche de menu AJUSTAGE**
Confirme les réglages effectués dans les menus
- ③ **Touche de menu MOINS**
Menüeinstellungen
- ④ **Touche de menu PLUS**
Réglages dans les menus

Fonction Minuterie



- ⑤ **DEL canal 1-5**
- ⑥ **Touche Montée**
Le volet roulant s'ouvre ou s'arrête
- ⑦ **Toutche Arrêt**
Le volet roulant s'arrête
- ⑧ **Touche Descente**
Le volet roulant s'ouvre ou s'arrête
- ⑨ **Touche Sélection de canal**
Pour la sélection d'un canal déterminé

Fonction Émetteur portatif

Description des DEL



éclairée



clignote



arrêt

Description Affichage

⑩ **Canal** affiche le canal actuel. Les canaux encadrés sont des canaux programmés.

⑪ **Jour de la semaine affiche le jour actuel.**
 1 = lu, 2 = ma, 3 = me,
 4 = je, 5 = ve, 6 = sa,
 7 = di

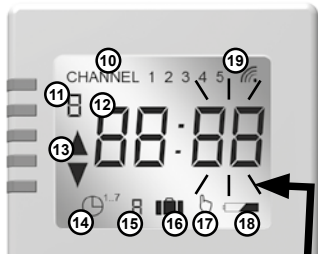



L'affichage clignote

⑫ **Heure:** affiche l'heure exacte ajustée.

⑬ **Temps d'ouverture et de fermeture automatique:**
 le sens de déplacement du volet roulant est affiché.

⑭ **Programme journalier et programme hebdomadaire:**

 = programme journalier = réglage de l'heure d'ouverture et de fermeture pour tous les jours de la semaine.

 = programme hebdomadaire = réglage individuel de l'heure d'ouverture et de fermeture pour chaque jour de la semaine.

⑮ **Fonction Astro** la fermeture au soir s'accorde aux différentes heures de coucher du soleil au cours de l'année.

⑯ **Fonction vacances et aléatoire** fonction complémentaire du programme journalier ou hebdomadaire. Modifie de manière aléatoire les heures programmées de +/- 15 minutes.

⑰ **Commande manuelle (protection contre la fermeture intempestive)** le volet roulant peut être manuellement monté et descendu. Désactive le mode automatique et protège la fermeture avant d'être rentrée.

⑱ **Indicateur de capacité de pile** s'affiche quand la pile est faible.

⑲ **Symbole radio** s'affiche uniquement en cas de radio-communication bidirectionnelle.

COUPLAGE AVEC LE SYSTÈME SMART HOME

Coupler le produit avec le système Smart Friends et gérer tous les produits « Ready for Smart Friends » à l'aide de l'application Smart Friends.

FR



www.smart-friends.com

SPIS TREŚCI

Bezpieczeństwo i wskazówki	29
Dane techniczne	32
Ilustracja produktu/Objaśnienie klawiszy / Wyświetlacz	33
Sprzężenie z systemem Smart Home	35
Wymagane narzędzia	44
Zakres dostawy	44
A Montaż	45
B Silnik rurowy: Przydzielanie adresu	51
C Start trybu programowania	53
D Wybór kanału	54
E Sprzężanie radiowego sterownika zegarowego PREMIUM	55
F Sprawdzanie kierunku obrotu silnika rurowego	57
G Zmiana kierunku obrotu	58
H Ustawianie górnego położenia krańcowego	59
I Ustawianie dolnego położenia krańcowego	61
J Zakończenie trybu programowania	63
K Ustawianie pozycji pośredniej (opcja)	64
L Kasowanie pozycji pośredniej	66
M Dosuw do pozycji pośredniej	68
N Dosuw do pozycji końcowej	69
O Sprzężanie dodatkowych radiowych sterowników zegarowych PREMIUM	70
P Wyrejestrowanie sprzężonych radiowych sterowników zegarowych PREMIUM	74
Q Reset fabryczny (silnik rurowy).....	78
R Ustawianie czasu i daty	83
S Przełączanie tryb ręczny/automatyczny	86
T Przełączanie program dobowy/tygodniowy	86
U Funkcja urlopowa (funkcja losowa)	87
V funkcji Astro	87
W Ustawianie programu dobowego	88
X Ustawianie programu tygodniowego	91
Y Programowanie funkcji Astro	94
Z Reset fabryczny (radiowy sterownik zegarowy PREMIUM)	97

BEZPIECZEŃSTWO I WSKAZÓWKI

Szanowna Klientko, Szanowny Kliencie



Przed montażem i uruchomieniem dokładnie przeczytaj niniejszą instrukcję. Przestrzegaj wszystkich zasad bezpieczeństwa przed przystąpieniem do pracy. Zachowaj tę instrukcję oraz informuj każdego użytkownika o ewentualnych zagrożeniach związanych z używaniem produktu. Przy każdej zmianie właściciela przekaż niniejszą instrukcję nowemu właścicielowi. Uszkodzenia spowodowane nieprawidłowym użytkowaniem lub wadliwym montażem powodują wygaśnięcie gwarancji.

PL

ZASADY BEZPIECZEŃSTWA



Niebezpieczeństwo śmierci wskutek porażenia elektrycznego! Przed przystąpieniem do prac na instalacji elektrycznej odłącz ją od napięcia.

- Zastosuj środki uniemożliwiające przypadkowe włączenie.
- Dotyczy to również konserwacji i napraw elektrycznych instalacji roletowych.
- Podłączenie do instalacji elektrycznej może być wykonane tylko przez uprawnionego elektryka.
- Nieprawidłowe wykonanie instalacji może doprowadzić do poważnych obrażeń i szkód materialnych.
- Przestrzegaj przepisów lokalnego zakładu energetycznego oraz wszystkich obowiązujących norm i przepisów dotyczących instalacji elektrycznych.

- Używaj produktu tylko w pomieszczeniach suchych (klasa ochrony IP20).
- Produkt i opakowanie nie mogą być używane do zabawy. Przechowuj je poza zasięgiem dzieci, niebezpieczeństwo obrażeń lub uduszenia.
- Nie otwieraj produktu, niebezpieczeństwo obrażeń.
- Dopilnuj, aby w strefie przesuwu rolety nie znajdowały się żadne osoby. Strefa przesuwu rolety musi być widoczna w trakcie używania urządzenia. Niebezpieczeństwo obrażeń.

UŻYCIE ZGODNE Z PRZEZNACZENIEM

- Produkt (Nr art. 20032/20037) jest przeznaczony wyłącznie do współpracy z atestowanymi produktami radiowymi firmy Alfred Schellenberg GmbH.
- Instalacja roletowa lub markizowa i jej części muszą znajdować się w nienagannym stanie technicznym. Wady instalacji lub jej części muszą być wyeliminowane przed zamontowaniem radiowego modułu odbiorczego.
- Inne lub wykraczające poza powyższe użytkowanie jest uważane za niezgodne z przeznaczeniem.
- Alfred Schellenberg GmbH nie odpowiada za szkody następcze, szkody materialne i osobowe, spowodowane użyciem niezgodnym z przeznaczeniem.
- Używanie ręcznego pilota radiowego w pobliżu urządzeń emitujących promieniowanie magnetyczne lub posiadających powierzchnie metalowe ma negatywny wpływ na jego prawidłowe działanie.
- Warunki budowlane mają negatywny wpływ na zasięg i działanie urządzenia radiowego.
- Urządzenia radiowego nie wolno używać w strefach wysokiego ryzyka lub zaburzeń osób trzecich (np. w szpitalach, na lotniskach i podobnych obiektach).



- Urządzenie nie ma żadnej ochrony przed zakłóceniami powodowanymi przez inne należycie zbudowane i użytkowane urządzenia radiowe. Zwłaszcza przez prawidłowo działające urządzenia, pracujące w tym samym zakresie częstotliwości.
- Zachowaj tę instrukcję, musi być dostępna dla każdego użytkownika.
- Produkt jest zaprojektowany do obsługi radiowej napędów radiowych, radiowych modułów odbiorczych i radiowych wyłączników odbiorczych firmy Alfred Schellenberg GmbH.

PRODUKT	NR. ART.
Radiowy silnik rurowy PREMIUM	20506, 20510, 20810,20820, 20840, 20507, 20511, 20811, 20821, 20841
Radiowy napęd taśmy rolety ROLLODRIVE 65 PREMIUM	22767, 22728
Radiowy napęd taśmy rolety ROLLODRIVE 75 PREMIUM	22576, 22578
Radiowy wyłącznik odbiorczy	20030, 20035
radiowego modułu	20017 ,20018
Gniazdko radiowe	20033, 20034, 20038, 20039
Radiowy wyłącznik światła	21002, 21004
Radiowy moduł oświetleniowy	21003, 21005
Marki Drive PLUS	20268, 20269

PL

Zestaw funkcji zależy od produktu. Dokładny opis można znaleźć w instrukcjach produktów.

DEKLARACJA ZGODNOŚCI UE

Radiowego sterownika zegarowego PREMIUM (Art. Nr.  20032,  20037) spełnia obowiązujące wymogi określone normami europejskimi i krajowymi. Zgodność została udokumentowana. Cały tekst deklaracji zgodności UE jest dostępny pod adresem: <http://www.schellenberg.de> (punkt menu „Service” w zakładce z materiałami do pobrania).



Radio Equipment Directive 2014/53/EU (RED)
RoHS Directive 2011/65/EU



Nie wyrzucać wraz z odpadami domowymi! Produkt nadaje się do recyklingu i można go oddać do zakładu recyklingowego lub do punktu zbiórki złomu elektrycznego.

DANE TECHNICZNE

Częstotliwość transmisji	868,4 MHz Schellenberg
Moc nadawcza	maks. 10 dBm / 10 mW
Zasięg na wolnej przestrzeni	do 150 metrów
Zasięg w budynku	do 20 metrów
Zasilanie napięciowe	2,4 – 3,0 Volt DC
Typ baterii	2x 1,5 V Typ AAA
Stopień ochrony	IP 20
temperatura otoczenia	0° – 50° Celsius
Kategoria odbiornika	3



Warunki budowlane mogą mieć negatywny wpływ na zasięg i działanie radiowego programatora zegarowego.

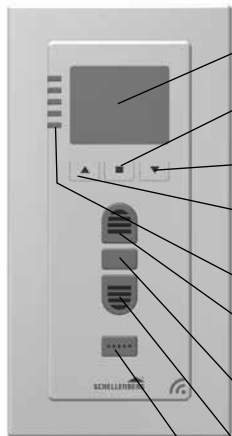

- ① **Wyświetlacz**
 - ② **Przycisk menu Set**
Potwierdza ustawienia menu
 - ③ **Przycisk menu Minus**
Ustawienia menu
 - ④ **Przycisk menu Plus**
Ustawienia menu
-
- ⑤ **LED kanału 1-5**
 - ⑥ **Przycisk podnoszenia**
Roleta podnosi się lub zatrzymuje
 - ⑦ **Przycisk stop**
Roleta zatrzyma się
 - ⑧ **Przycisk opuszczania**
Roleta podnosi się lub zatrzymuje
 - ⑨ **Przycisk wyboru kanału**
Do wywołania określonego kanału

Opis diod LED

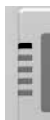

świeci



miga



wył.

Opis Wyświetlacz

⑩ **Kanał** wyświetla aktualny kanał. Kanały obwiedzione kółkiem to kanały zaprogramowane.

⑪ **Dzień tygodnia** wyświetla aktualny dzień tygodnia.
1 = Pon, 2 = Wt, 3 = Śr,
4 = Czw, 5 = Pią, 6 = Sob,
7 = Nie





Wskaźnik
miga

⑫ **Czas zegarowy** wyświetla ustawiony czas zegarowy.

⑬ **Automatyczny czas podnoszenia i opuszczania:** wyświetlany jest kierunek przesuwu rolety.

⑭ **Program dobowy i tygodniowy**

 = program dobowy = ustawienie czasu podniesienia i opuszczenia na wszystkie dni tygodnia.

 = Program tygodniowy = indywidualne ustawienie czasu podniesienia i opuszczenia na każdy dzień tygodnia.

⑮ **Funkcja Astro** wieczór kończy się przez cały rok po zachodzie słońca.

⑯ **Funkcja urlopowa i losowa** może być dołączona do programu dobowego i tygodniowego. Zmienia zaprogramowane czasy losowo w granicach +/- 15 minut.

⑰ **Obsługa ręczna (zabezpieczenie przed uwięzieniem):** roletę można podnosić i opuszczać ręcznie. Wyłącza tryb automatyczny i zabezpiecza przed przypadkowym uwięzieniem.

⑱ **Wskaźnik stanu baterii** ukazuje się, gdy bateria jest słaba.

⑲ **Symbol radia** ukazuje się tylko przy dwukierunkowej komunikacji radiowej.

SPRZĘŻENIE Z SYSTEMEM SMART HOME

Produkt można skojarzyć z systemem Smart Friends i sterować wszystkimi produktami „Ready for Smart Friends” razem przez aplikację Smart Friends.



PL

www.smart-friends.com

INDICE

Sicurezza ed avvertenze	37
Dati tecnici	40
Immagine prodotto / Descrizione tasti / Display	41
Accoppiamento sistema smart home	43
Utensili necessari	44
Fornitura	44
A Montaggio	45
B Motore tubolare: Assegnazione indirizzo	51
C Avvio modo di programmazione	53
D Selezione canale	54
E Accoppiamento del timer via radio PREMIUM	55
F Verifica del senso di rotazione del motore tubolare	57
G Modifica del senso di rotazione	58
H Regolazione del finecorsa superiore	59
I Regolazione del finecorsa inferiore	61
J Fine del modo di programmazione	63
K Impostazione della posizione intermedia (optional)	64
L Cancellazione della posizione intermedia	66
M Raggiungimento della posizione intermedia	68
N Raggiungimento del finecorsa	69
O Accoppiamento degli altri timer via radio PREMIUM	70
P Disconnessione del timer via radio PREMIUM accoppiato	74
Q Reset impostazioni (motore tubolare).....	78
R Impostazione data e ora	83
S Commutazione manuale e automatica	86
T Commutazione programma giornaliero e settimanale	86
U Funzione ferie (funzione random)	87
V funzione Astro	87
W Impostazione programma giornaliero	88
X Impostazione programma settimanale	91
Y Programmazione funzione Astro	94
Z Reset impostazioni (timer via radio PREMIUM).....	97

SICUREZZA ED AVVERTENZE

Gentile cliente,



prima di procedere al montaggio e all'utilizzo dell'apparecchio si prega di leggere attentamente le istruzioni. Rispettare tutte le avvertenze prima di procedere con i lavori. Conservare le istruzioni ed informare eventuali utenti sui rischi correlati all'uso del presente prodotto. In caso di cambio di proprietà, consegnare le presenti Istruzioni al nuovo proprietario. In caso di danni causati da un uso improprio o da un montaggio errato, si estingue qualsiasi diritto di garanzia.

IT

AVVERTENZE DI SICUREZZA



Rischio mortale a causa di scosse elettriche!
Prima di qualsiasi intervento su impianti elettrici, è necessario scollegare sempre la rete elettrica.

- Prendere le dovute precauzioni contro un'attivazione involontaria.
- Ciò vale anche per la riparazione e la manutenzione su avvolgibili elettriche.
- I collegamenti elettrici possono essere eseguiti solo da un elettricista autorizzato e specializzato.
- Una installazione eseguita in modo errato può provocare gravi danni a persone o cose.
- Devono essere rispettate le norme del fornitore locale di energia elettrica e le norme e regolamentazioni generali per le installazioni elettriche.

- Usare il prodotto solo in ambienti asciutti (Classe di protezione IP20).
- Il prodotto e l'imballaggio non sono un giocattolo. Tenere lontano dalla portata dei bambini. Sussiste il rischio di lesioni o di soffocamento.
- Non aprire il prodotto. Sussiste il rischio di lesioni.
- Tenere lontano le persone dall'area di spostamento dell'avvolgibile. L'area di spostamento dell'avvolgibile durante il funzionamento deve essere visibile. Sussiste il rischio di lesioni.

USO CONFORME

- Il prodotto (N. art. 20032/20037) è omologato esclusivamente per i prodotti funzionanti via radio benestariati della ditta Alfred Schellenberg GmbH.
- Gli impianti per avvolgibili ed i loro componenti devono trovarsi in uno stato perfetto. Eventuali difetti sull'impianto o sui suoi componenti devono essere risolti prima del montaggio del modulo di ricezione radio.
- Un impiego diverso o che non rientri in quello previsto del prodotto non è considerato conforme.
- La Alfred Schellenberg GmbH non si assume alcuna responsabilità per danni conseguenti, danni a persone e cose nel caso di un impiego diverso rispetto a quello previsto.
- L'utilizzo del trasmettitore radio manuale vicino ad apparecchi con radiazione magnetica o superfici metalliche pregiudica il corretto funzionamento.
- Le costruzioni presenti pregiudicano la portata ed il funzionamento dell'impianto radio.
- L'impianto radio non deve essere utilizzato in ambienti con un rischio elevato di interferenza verso terzi (ad es. ospedali, aeroporti o strutture simili).



- Non sussiste alcuna protezione da interferenze a causa di altri impianti radio realizzati ed usati a regola d'arte. In particolare ad opera di impianti a regola d'arte che operano sulla stessa frequenza.
- Si prega di conservare accuratamente le istruzioni e di metterle a disposizione degli altri utenti.
- Il prodotto è omologato per il controllo radio di unità radio, moduli di ricezione radio ed interruttori di ricezione via radio della ditta Alfred Schellenberg GmbH.

PRODOTTO	N. ART.
Motore tubolare radio PREMIUM	20506, 20510, 20810, 20820, 20840, 20507, 20511, 20811, 20821, 20841
Trasmissione radio cinghia per avvolgibili ROLLODRIVE 65 PREMIUM	22767, 22728
Trasmissione radio cinghia per avvolgibili ROLLODRIVE 75 PREMIUM	22576, 22578
Interruttore di ricezione via radio	20030, 20035
Modulo di ricezione radio.	20017 ,20018
Presa radiocomandata	20033, 20034, 20038, 20039
Interruttore radio luci	21002, 21004
Modulo luci via radio	21003, 21005
Marki Drive PLUS	20268, 20269

IT

La funzione dipende dal relativo prodotto. Per una descrizione più dettagliata rimandiamo alle istruzioni sui prodotti.

DICHIARAZIONE DI CONFORMITÀ UE

Del timer via radio PREMIUM (Art. Nr.  20032,  20037) soddisfa i requisiti in vigore delle direttive europee e nazionali. La conformità è stata comprovata. Il testo completo della dichiarazione di conformità UE è disponibile al seguente indirizzo: <http://www.schellenberg.de> (voce menu "Service" nel Centro download).



Radio Equipment Directive 2014/53/EU (RED)
RoHS Directive 2011/65/EU



Non smaltire insieme ai rifiuti domestici! Il prodotto è riciclabile e può essere consegnato presso un centro di raccolta specializzato per rifiuti elettrici.



DATI TECNICI

Frequenza di trasmissione	868,4 MHz Schellenberg
Potenza di emissione	max 10 dBm / 10 mW
Portata all'aperto	fino a 150 metri
Portata nell'edificio	fino a 20 metri
Alimentazione della tensione	2,4 – 3,0 Volt DC
Tipo batterie	2x 1,5 V Typ AAA
Tipo di protezione	IP 20
Temperatura ambiente	0° – 50° Celsius
Categoria ricevitore	3



Le costruzioni presenti possono pregiudicare la portata e il funzionamento del timer via radio.

IMMAGINE PRODOTTO / DESCRIZIONE TASTI / DISPLAY

Funzionamento timer

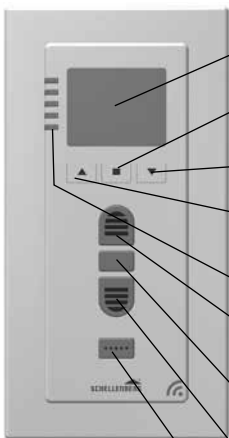

- ① **Display**
- ② **Tasto menu Imposta**
Conferma le opzioni del menu
- ③ **Tasto menu Meno**
Opzioni del menu
- ④ **Tasto menu Più**
Opzioni del menu

- ⑤ **Canale LED 1-5**
- ⑥ **Tasto Salita**
L'avvolgibile sale o si arresta
- ⑦ **Tasto Stop**
L'avvolgibile si arresta
- ⑧ **Tasto Discesa**
L'avvolgibile sale o si arresta
- ⑨ **Tasto Selezione canale**
Per selezionare un determinato canale

Funzionamento telecomando

Descrizione dei LED

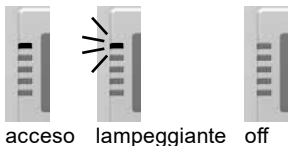

acceso lampeggiante off



IT

Descrizione Display

- ⑩ **Canale** mostra il canale attuale.. I canali racchiusi entro un circoletto sono i canali programmati.
- ⑪ **Giorno della settimana** mostra l'attuale giorno della settimana.
1 = Lu, 2 = Mai, 3 = Me,
4 = Gi, 5 = Ve, 6 = Sa, 7 = Do



L'indicazione lampeggia

- ⑫ **Ora** mostra l'ora impostata.
- ⑬ **Tempo automatico di salita e discesa** viene mostrata la direzione di spostamento dell'avvolgibile.
- ⑭ **Programma giornaliero e settimanale**
 = programma giornaliero = impostazione del tempo di salita e discesa per tutti i giorni della settimana.
 = Programma settimanale = impostazione individuale del tempo di salita e discesa per ogni giorno della settimana.
- ⑮ **Funzione Astro** la chiusura serale avviene dopo il tramonto nel corso dell'anno.
- ⑯ **Funzione ferie e random** inseribile nel programma giornaliero o settimanale. cambia i tempi programmati in modo casuale di max. +/- 15 minuti.
- ⑰ **Comando manuale (sicurezza per non chiudersi fuori)** l'avvolgibile si può alzare e abbassare manualmente. Disattiva la modalità automatica e impedisce di chiudersi involontariamente fuori.
- ⑱ **Indicazione batteria** si attiva se la carica della batteria è insufficiente.
- ⑲ **Simbolo radio** si attiva solo in caso di segnale radio bidirezionale.

ACCOPPIAMENTO SISTEMA SMART HOME

Collegare il prodotto con il sistema Smart Friends e controllate tra loro tutti i prodotti „Ready for Smart Friends“ tramite l'applicazione Smart Friends.



IT



www.smart-friends.com

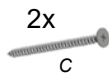
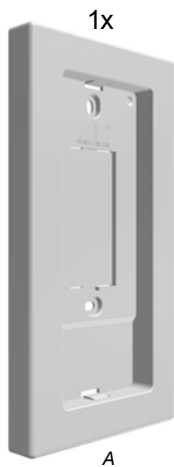

A

1.

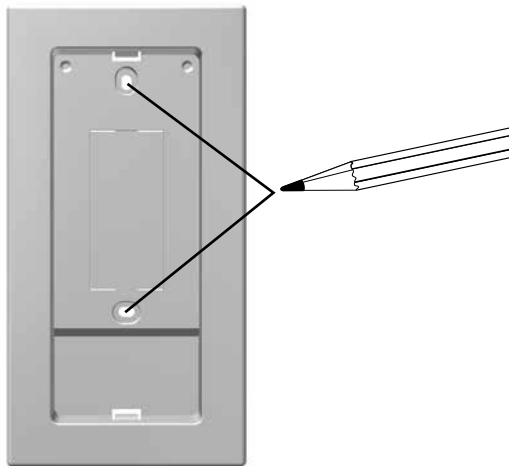

A

2.

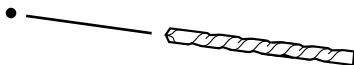
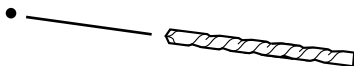

3.

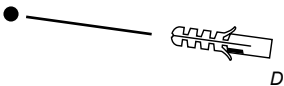
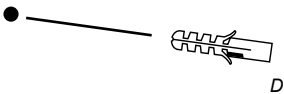

4.



5.

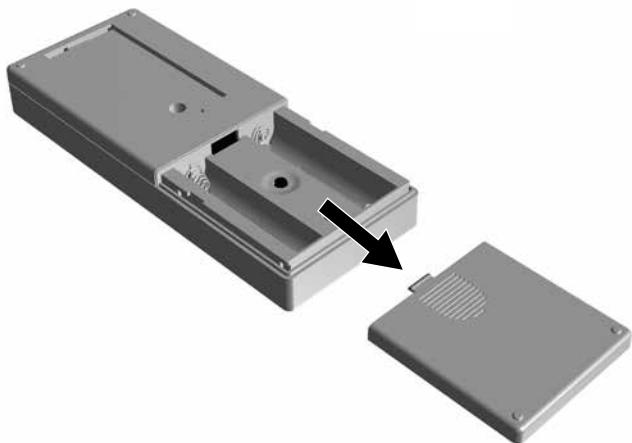

6.

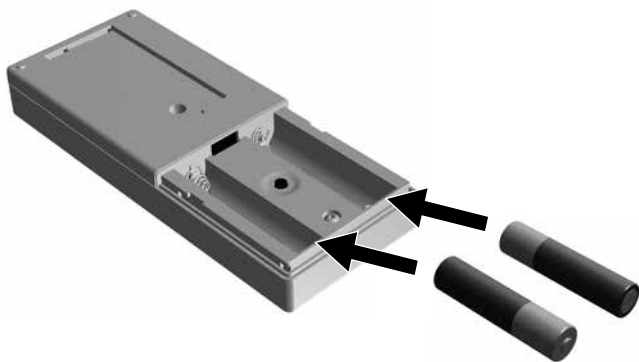

7.

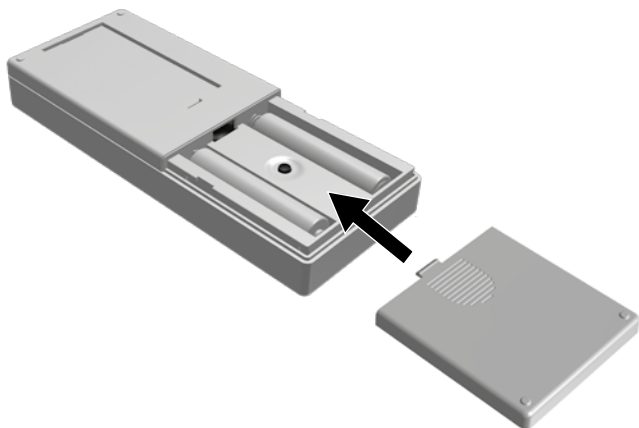

8.

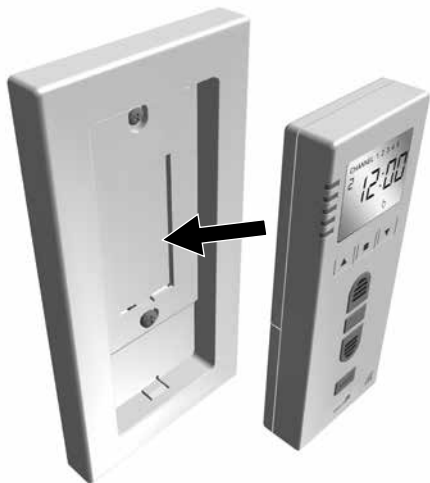

B

9.

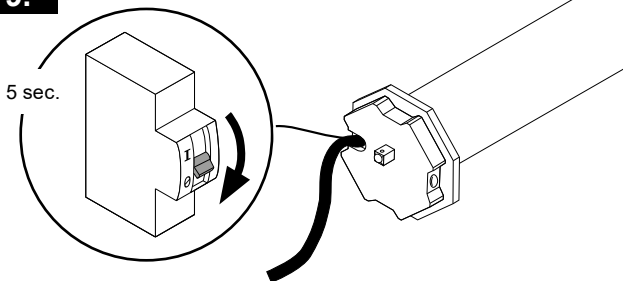

10.

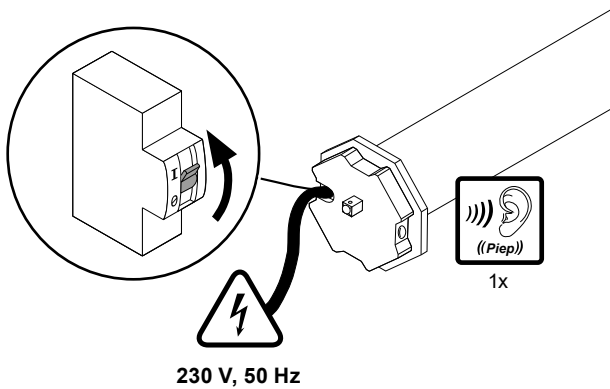

11.

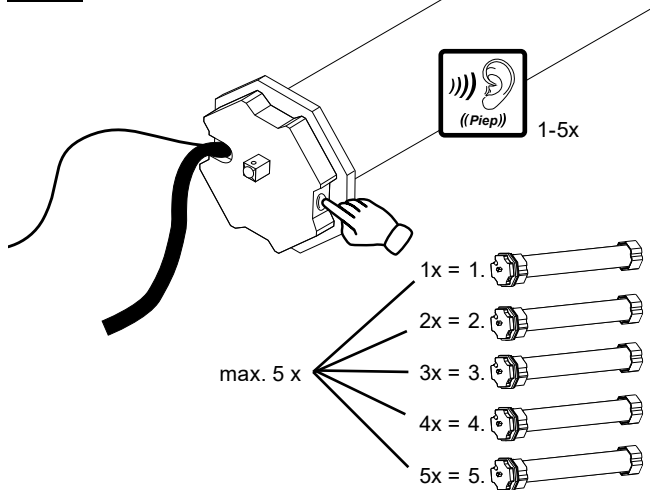

C

12.

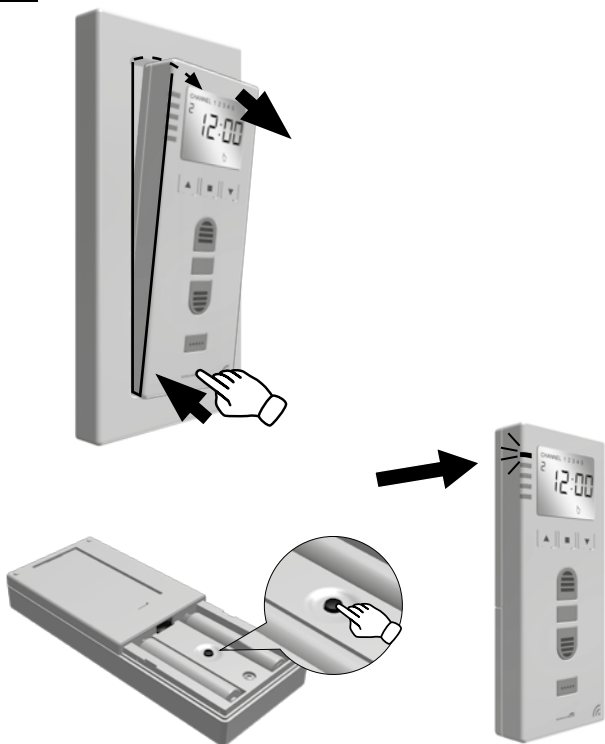

D

13.



E

14.

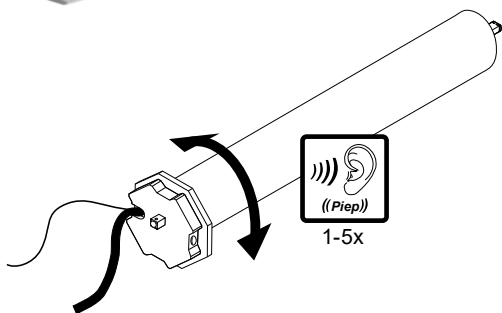
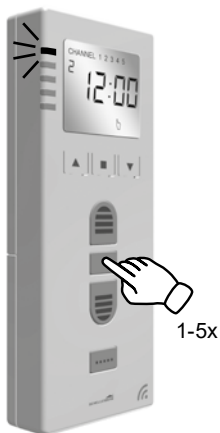

15.



max 4 sec.



16.

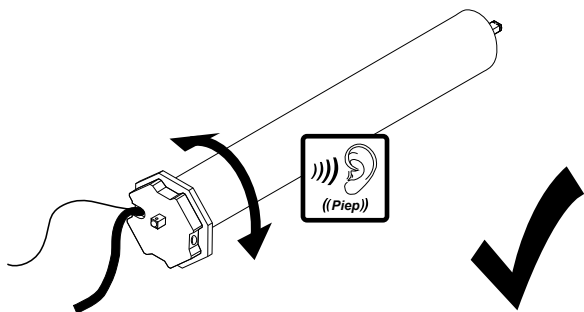

F

17.

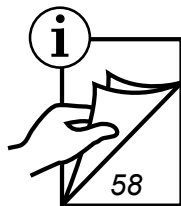
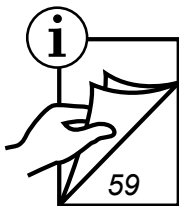
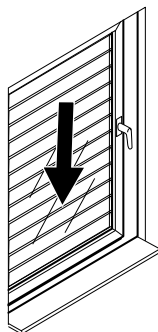
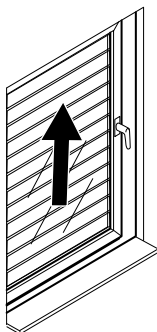

G

18.

19.

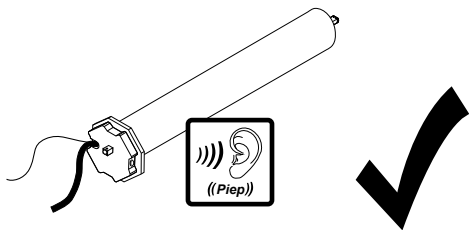
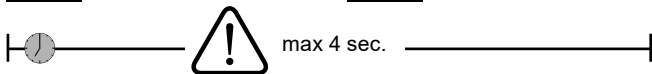

H

20.



21.



90 %

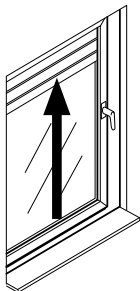

100 %

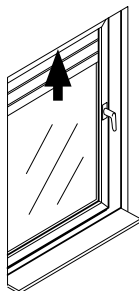

22.



23.



1

2

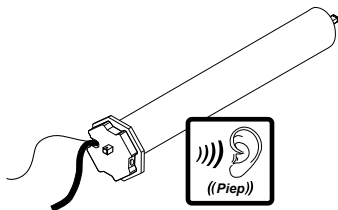
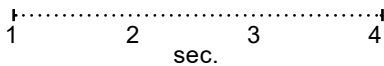

24.

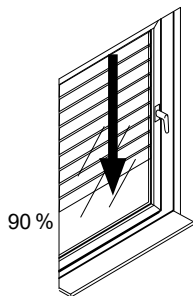

25.

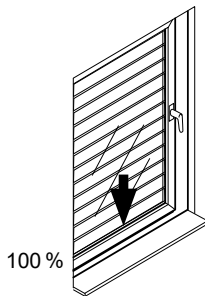
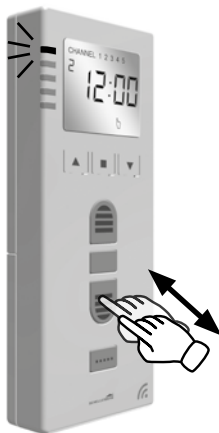

26.



1

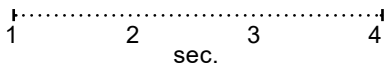

27.



2

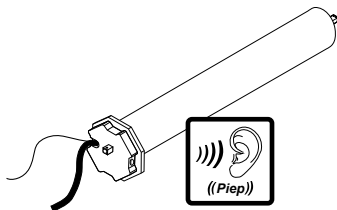

J

28.

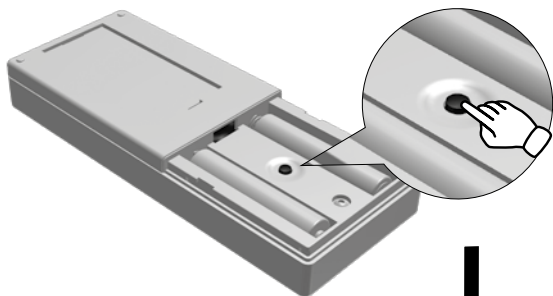

K

29.



z.B. 60 %

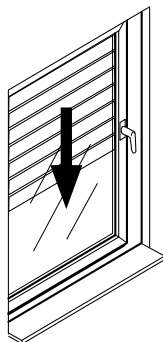

30.



1

1 2 3 4
sec.

31.



2

32.

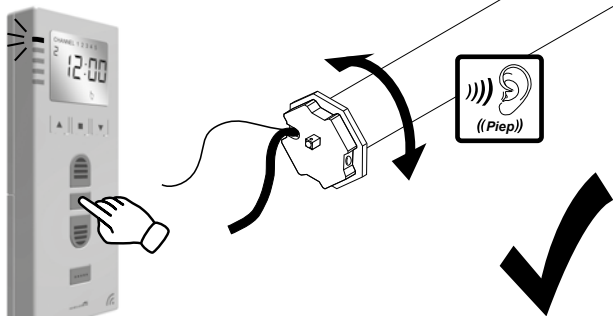

L

33.

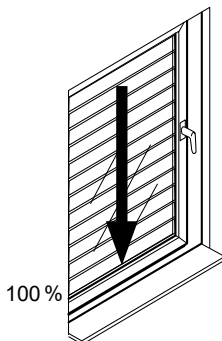
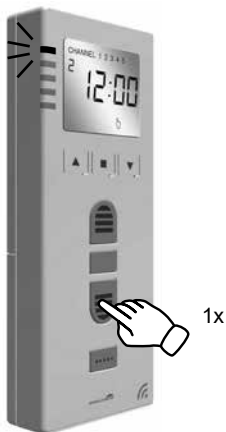

34.



35.



1

2

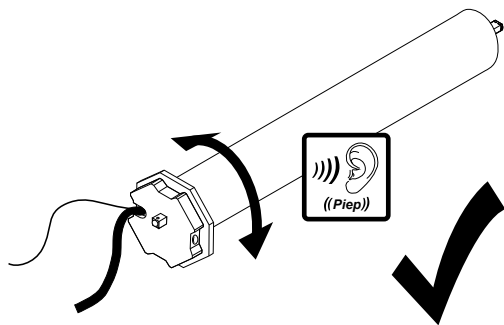
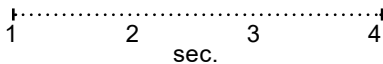

M

36.

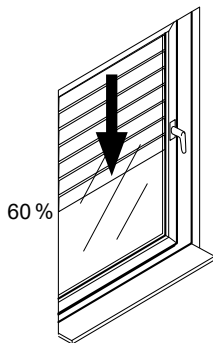
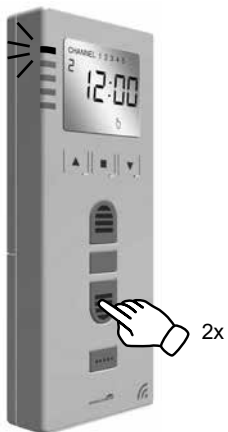

N

37.

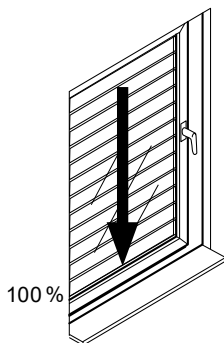
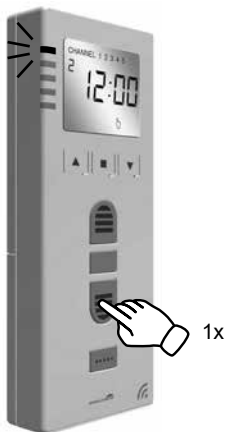

O

38.



1 + 2 ... 5

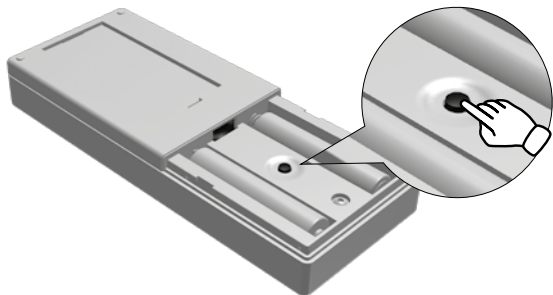



1-5x



1-5x

1**+****2**

...

5

40.

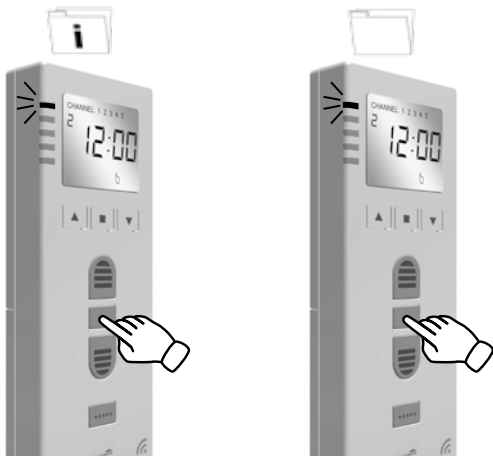

1

2

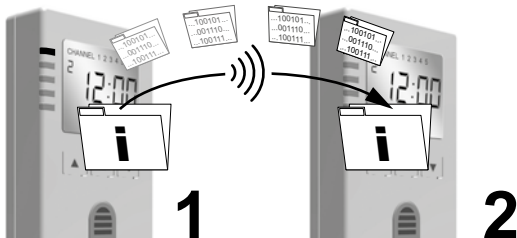
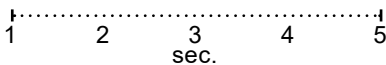

1

2

41.



1 + 2 ... 5

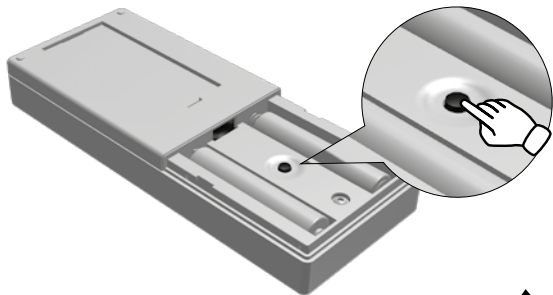

P

42.

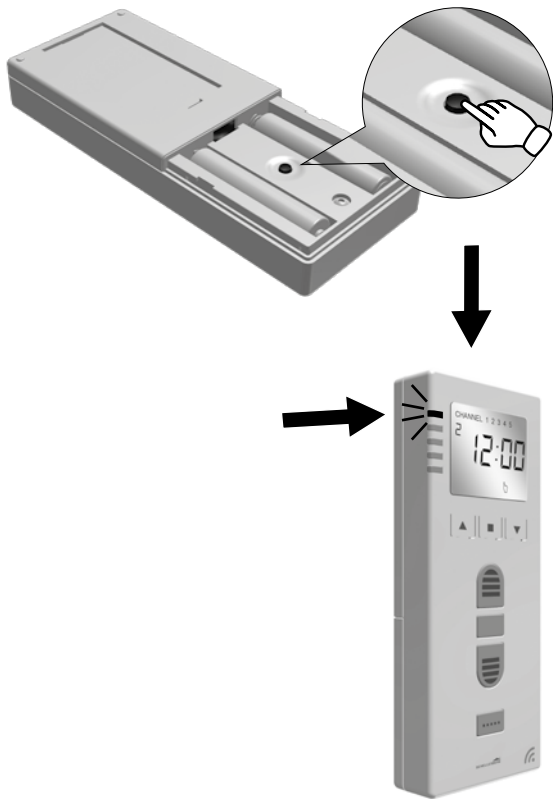

43.

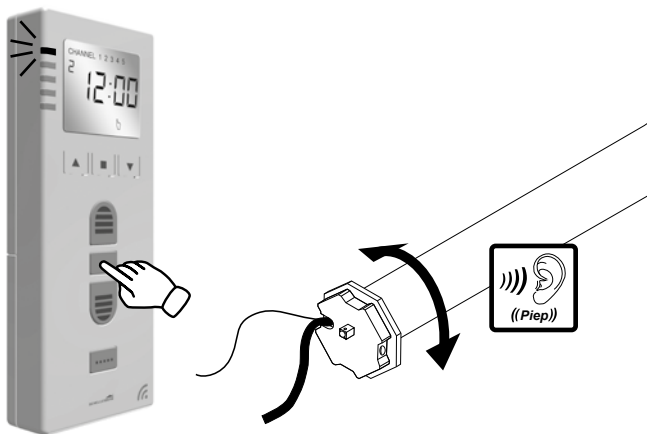

44.



45.



46.



47.



48.



49.

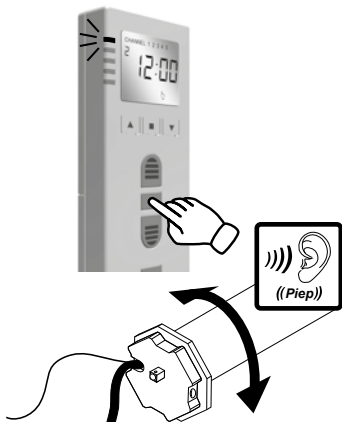

50.

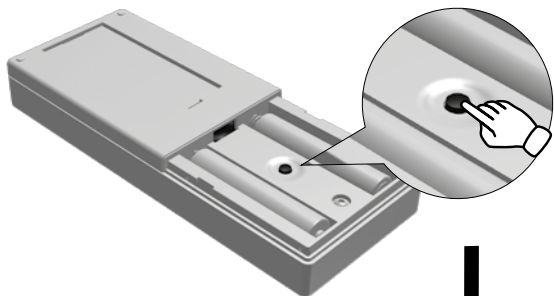

Q

51.

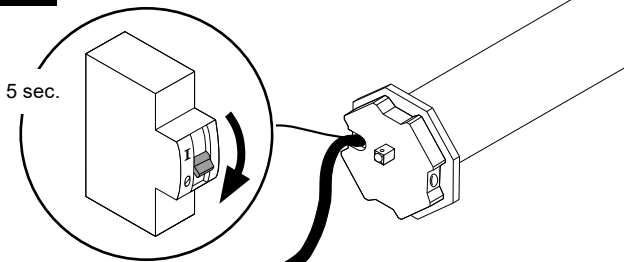

52.

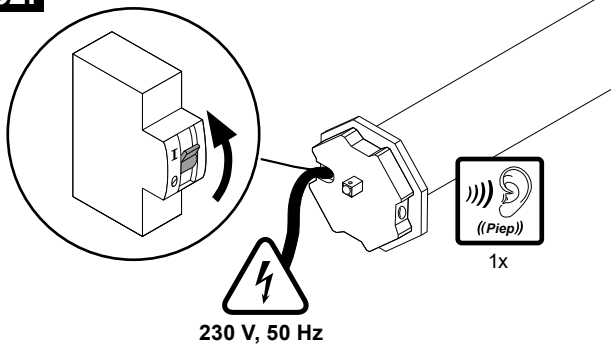

12.

...

50.



53.

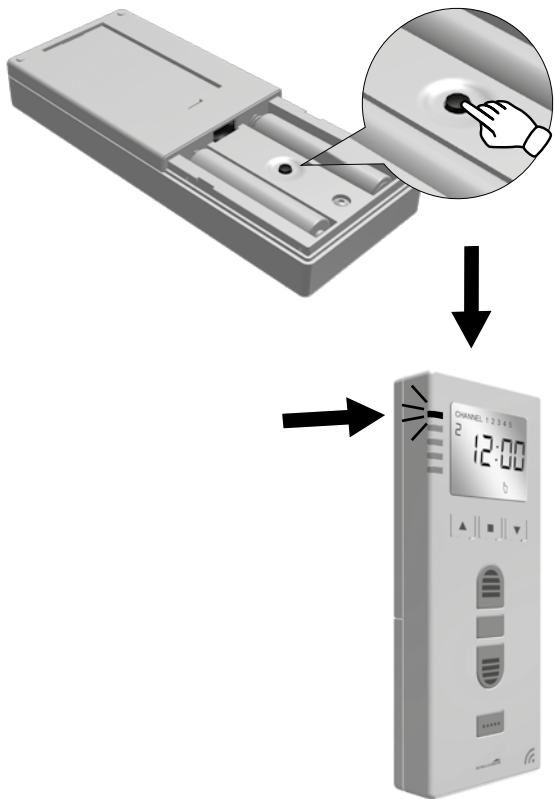

54.



55.



56.



57.



58.



59.

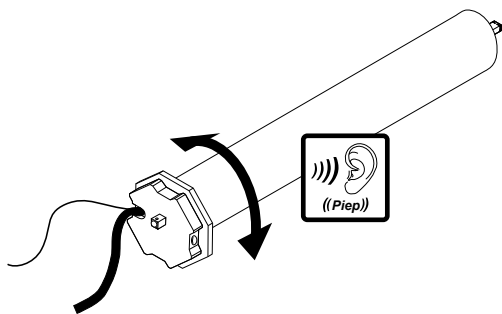

60.

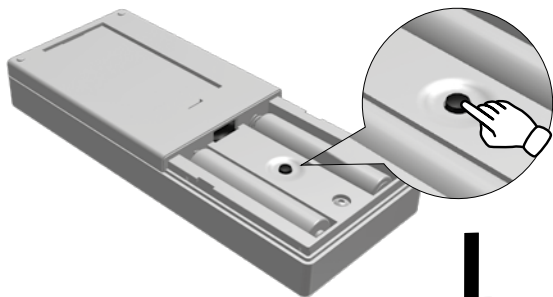

R

61.



62.



63.

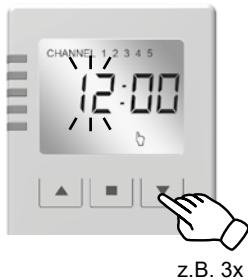

64.



65.



66.



67.

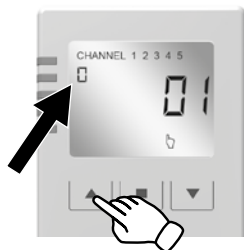

Einstellung Datum: **Tag**

68.



69.

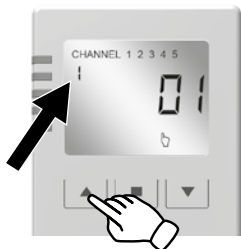

Einstellung Datum: **Monat**

70.



71.

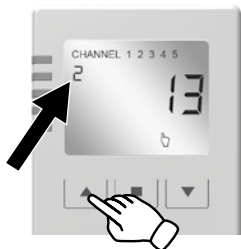

Einstellung Datum: **Jahr**

72.



S

73.



74.



T

75.

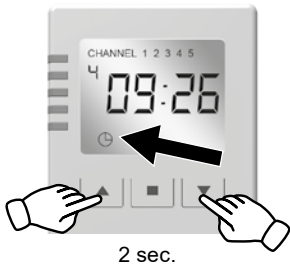

76.



U

77.



78.



V

79.



80.



W

81.



82.



83.



84.



85.



86.



87.



88.



89.



90.



X

91.



T



92.



93.

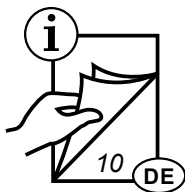

94.

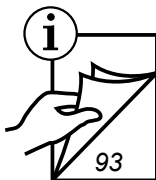
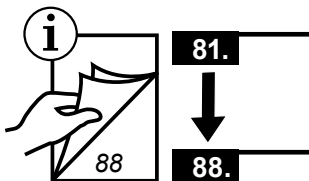



2

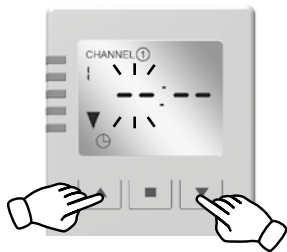
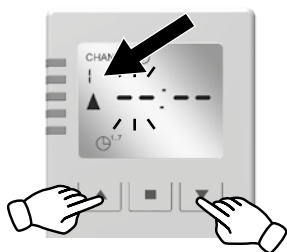

Y

93.

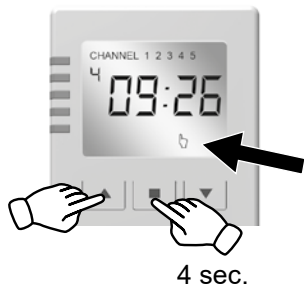

94.

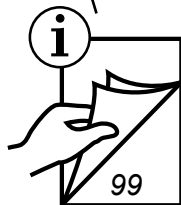
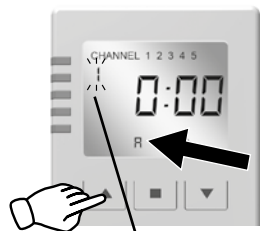

97.



98.



99.



100.



Max.: -1:59 h / +1:59 h

101.



102.



103.



104.



Z

105.



106.



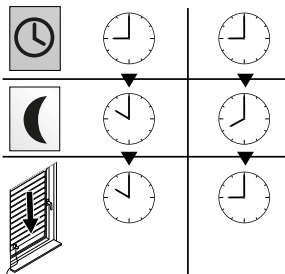

A	B
35°	1
40°	2
45°	3
50°	4
55°	5
60°	6
65°	7



B	C
1	ES
2	PT, ES, IT, AL, KO, GR, TR
3	FR, CH, IT, SI, HR, BA, HU, RS, RO, ME, KO, BG, TR
4	GB, FR, BE, NL, DE, CH, AT, CZ, PL, SK, HU, UA, MD, RO, RU
5	GB, NL, DE, DK, NO, SE, PL, LT, LV, WR, UA, RU
6	GB, NO, SE, FI, LV, EE, RU
7	IS, NO, SE, FI, RU

- DE** Bei Garantie, Ersatzteilbedarf oder Fragen rund um die sachgemäße Montage Ihres Produktes wenden Sie sich bitte an unseren Kunden-Service.
service.int@schellenberg.de
- GB** For warranty claims, spare parts requests or questions regarding the proper installation of your product, please contact our Consumer Service Department.
service.int@schellenberg.de
- FR** Pour ce qui est des revendications de garantie, si vous avez besoin de pièces de rechange ou si vous avez des questions relatives au montage de votre produit, veuillez contacter notre service après-vente.
service.int@schellenberg.de
- PL** W razie roszczeń gwarancyjnych, zapotrzebowania na części zamienne lub pytań dotyczących prawidłowego montażu produktu należy zwrócić się do naszego serwisu.
service.int@schellenberg.de
- IT** Per la garanzia, pezzi di ricambio o informazioni sulle operazioni di montaggio corrette del prodotto, si prega di contattare il servizio di assistenza clienti.
service.int@schellenberg.de



Alfred Schellenberg GmbH

An den Weiden 31
57078 Siegen
www.schellenberg.de