

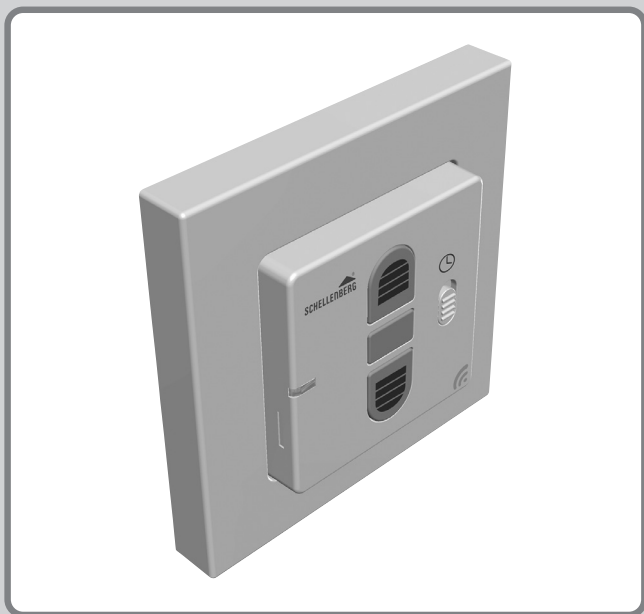

SCHELLENBERG

Smart Home



DE GB FR PL IT

deutsch	4	DE
english	11	GB
français	18	FR
polski	25	PL
italiano	32	IT

INHALTSVERZEICHNIS

Sicherheit und Hinweise	5
Technische Daten	8
Legende Symbole	9
Kopplung Smart Home System	10
Benötigte Werkzeuge	39
Lieferumfang	39
A Montage	40
B Batterie einlegen	42
C Rohrmotor: Adresse zuweisen	45
D Programmiermodus starten	47
E Funk-Zeitschaltuhr mit Rohrmotor koppeln	48
F Drehrichtung prüfen	50
G Drehrichtung ändern	51
H Endlage oben einstellen	52
I Endlage unten einstellen	54
J Programmiermodus beenden	56
K Endlage anfahren	57
L Weitere Funk-Sender koppeln	58
M Zeitautomatik aktivieren	61
N Zeitautomatik: Auf- und Abfahrzeit programmieren	63
O Zeitautomatik: Auf- und Abfahrzeit löschen	65
P Zeitautomatik deaktivieren (Aussperrschutz)	66
Q Gekoppelte Funk-Zeitschaltuhr löschen	67
R Werksreset	71
S Zwischenlage setzen (optional)	76
T Zwischenlage löschen	77
U Zwischenlage anfahren	79

Sehr geehrte Kundin, sehr geehrter Kunde,



bitte lesen Sie vor der Montage und Inbetriebnahme diese Anleitung vollständig durch. Beachten Sie alle Sicherheitshinweise, bevor Sie mit den Arbeiten beginnen. Bewahren Sie die Anleitung auf und weisen Sie jeden Benutzer auf eventuelle Gefahren hin, die im Zusammenhang mit diesem Produkt stehen. Übergeben Sie die Anleitung bei einem Besitzerwechsel auch dem Nachbesitzer. Bei Schäden, die durch unsachgemäßen Gebrauch oder durch fehlerhafte Montage entstehen, erlischt die Garantie und jeder Gewährleistungsanspruch.

SICHERHEITSHINWEISE



Es besteht Verletzungsgefahr durch Stromschlag. Vor Arbeiten an elektrischen Anlagen müssen diese spannungsfrei geschaltet werden.

- Das Produkt nur in trockenen Räumen verwenden.
- Die funkbetriebene Rollladenanlage muss während des Betriebs einsehbar sein, insbesondere wenn die Rollladenanlage durch mehr als einen Funk-Sender angesteuert wird.
- Halten Sie Personen aus dem Fahrbereich der Rollladenanlage fern. Es besteht Verletzungsgefahr.
- Das Produkt ist kein Spielzeug, halten Sie Kinder davon fern.
- Es besteht Verletzungs- und Erstickungsgefahr durch Kleinteile des Produktes und der Verpackung.



- Für den Betrieb einer Rollladenanlage über das Produkt müssen die landesspezifischen Bestimmungen beachtet werden.
- Batterien nur durch den gleichen Typ ersetzen, Flachbatterie CR 2450.
- Den Rohrmotor nicht über die Endlagen hinaus fahren. Beschädigungsgefahr!

BESTIMMUNGSGEMÄSSE VERWENDUNG

- Das Produkt (Art. Nr. 20031/20036) nur mit Geräten verbinden, die vom Hersteller dafür zugelassen sind.
- Eine andere oder darüber hinausgehende Verwendung des Produktes gilt als nicht bestimmungsgemäß.
- Das Produkt darf nicht in Bereichen mit hohem Risiko der Störung Dritter (z.B. Krankenhäuser, Flughäfen oder ähnlichen Einrichtungen) betrieben werden.
- Es besteht kein Schutz vor Störungen durch andere ordnungsgemäß aufgebaute und betriebene Funkanlagen, insbesondere durch solche, die im gleichen Frequenzbereich arbeiten.
- Die über das Produkt betriebenen Rollladenanlagen müssen in einem einwandfreien Zustand sein.
- Für Folgeschäden, Sachschäden und Personenschäden bei nicht bestimmungsgemäßer Verwendung haftet die Alfred Schellenberg GmbH nicht.
- Der Betrieb des Produktes in der Nähe von Geräten mit magnetischer Strahlung oder metallischen Flächen beeinträchtigt die störungsfreie Funktion.
- Die Reichweite des Produktes ist durch europäische Verordnungen und Richtlinien des Gesetzgebers begrenzt.
- Die Reichweite des Produktes beträgt ca. 150 Meter auf freiem Feld und ca. 20 Meter im Gebäude.

EU-KONFORMITÄTSERKLÄRUNG

DE

Die Funk-Zeitschaltuhr (Art. Nr.  20031,  20036) erfüllt die geltenden Anforderungen der europäischen und nationalen Richtlinien. Die Konformität wurde nachgewiesen. Der vollständige Text der EU-Konformitätserklärung ist unter der folgenden Internetadresse verfügbar: <http://www.schellenberg.de> (Menüpunkt „Service“ im Download-Center)



Funkanlagenrichtlinie 2014/53/EU (RED)
RoHS-Richtlinie 2011/65/EU



Nicht im Hausmüll entsorgen! Das Produkt ist recyclingfähig und kann im Wertstoffhof oder an einer anderen Sammelstelle für elektrischen Hausmüll abgegeben werden.

Akkus/Batterien: Werfen Sie Akkus oder Batterien nicht in den Hausmüll, ins Feuer oder ins Wasser. Akkus und Batterien sollen gesammelt, recycelt oder auf umweltfreundliche Weise entsorgt werden.

TECHNISCHE DATEN

Sendefrequenz	868,4 MHz Schellenberg
Reichweite Freifeld	bis zu 150 Meter
Reichweite im Gebäude	bis zu 20 Meter
Spannungsversorgung	3 Volt DC
Batterietyp	CR 2450
Schutzart	IP 20
Umgebungstemperatur	0° – 50° Celsius



Die baulichen Gegebenheiten können die Reichweite und Funktion des Produktes beeinträchtigen.

LEGENDE SYMBOLE

DE

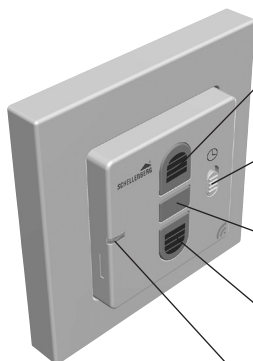

Taste Auffahrt

Rollladen/Markise fährt nach oben/aus.

Schiebeschalter Zeitautomatik

Rollladen fährt zu programmierten Zeiten oder wird manuell betrieben.

Taste Stopp

Stoppt die Auf-/Abfahrt des Rohrmotors.

Taste Abfahrt

Rollladen/Markise fährt nach unten/ein.

LED-Anzeige

Blinkt während der Programmierung.

Batteriefach

Für Batterietyp CR2450.

Taste Programmierung

Ein- und Ausschalten des Programmiermodus

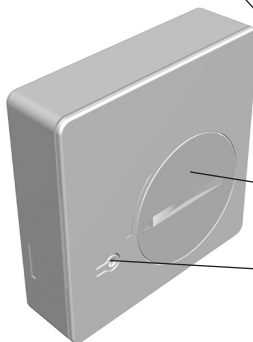

LED
aus



LED
leuchtet



LED
blinkt

KOPPLUNG SMART HOME SYSTEM

Koppeln Sie das Produkt mit dem Schellenberg Smart Home System oder dem Smart Friends System und benutzen Sie alle Schellenberg Funk-Produkte bzw. „Ready für Smart Friends“-Produkte über eine App miteinander.

SCHELLENBERG SMART HOME SYSTEM



Art.Nr. 21000



www.schellenberg.de/SH1/

SMART FRIENDS SYSTEM



Art.Nr. 26000

ABUS
Paulmann
Schellenberg
Steinel



www.smart-friends.com

TABLE OF CONTENTS

GB

Safety and notices	12
Technical data	15
Legend symbols	16
Pairing with Smart Home System	17
Required tools	39
Scope of delivery	39
A Installation	40
B Insert the battery	42
C Tubular motor: Address assignment	45
D Programming mode start	47
E Pair the wireless timer with the tubular motor	48
F Tubular motor rotation check	50
G Tubular motor direction change	51
H Setting the upper end position	52
I Setting the lower end position	54
J Concluding the programming mode	56
K End position approach	57
L Pairing of further wireless transmitters	58
M Automatic timer activation	61
N Automatic timer: programming of the opening and closing times ...	63
O Automatic timer: deletion of the opening and closing times	65
P Automatic timer deactivation (lock-out protection)	66
Q Deletion of a paired wireless timer	67
R Factory default reset	71
S Intermediate position setting (optional)	76
T Intermediate position deletion	77
U Intermediate position approach	79

Copyright protected, 2021 Alfred Schellenberg GmbH. All rights reserved. Any use, in particular reproduction, translation, processing or transmission of content into data-bases or other electronic media and systems beyond the authorization provided by the copyright legislation is strictly prohibited.

SAFETY AND NOTICES

Dear customers,



Please completely read this instruction manual before the installation and commissioning. Observe all safety instructions before you begin to work. Keep the instruction manual stored at hand and advise each user about possible dangers that are related to this product. When ownership to this product changes, hand this instruction manual over to the new owner. In case of damage which is caused by misuse or improper installation the warranty and any warranty claim will be void.

SAFETY INSTRUCTIONS



There is danger to life from electric shock!
Before working on electrical equipment, it must be completely de-energized.

- The product may only be used in dry rooms (IP20).
- The radio-controlled shutter system must be accessible during operation, especially when the roller shutter system is controlled by more than one hand-held wireless remote controller.
- Keep people away from the movement range of the roller shutter system. There is a risk of injury.
- The product and the packaging are not toys. Keep children away from it, since there is a risk of injury or suffocation.
- When using a wireless timer the country-specific regulations must be observed.



- Only replace the batteries with the same type, coin battery CR 2450.
- Do not move the tubular motor beyond the end positions.
Risk of damage!





INTENDED USE

- Only connect the product (Item No. 20031/20036) with devices that are approved by the manufacturer for the respective use.
- Any other or further utilization beyond the explicitly specified shall be regarded as not intended use.
- The product may not be operated in areas with high risk of interference from third party (e.g. hospitals, airport or similar facilities).
- There is no protection from interference from other properly constructed or operated radio equipment. Particularly from properly operating systems that utilize the same frequency range.
- The roller shutter systems which are operated with the product must be in a flawless condition.
- Alfred Schellenberg GmbH shall not be liable for any consequential damage, property damage and personal injury due to improper use.
- Le fonctionnement du radioémetteur portatif à proximité d'appareils à rayonnement électromagnétique ou à proximité de surfaces métalliques peut être entravé par des perturbations.
- The range of the product is limited by European regulations and legislative directives.
- The range of the product is approx. 150 meters in the open field, and 20 meters within buildings.

EU DECLARATION OF CONFORMITY

The Wireless timer (item no.  20031,  20036) meets the applicable requirements of European and national regulations. Conformity has been demonstrated. The full EU Declaration of Conformity document can be found at: <http://www.schellenberg.de> (under 'Download-Center', in the 'Service' tab).

 Radio Equipment Directive 2014/53/EU (RED)
RoHS Directive 2011/65/EU

 Do not dispose of together with household waste. The product is recyclable and can be deposited at a recycling center or a collection station for electrical household garbage.

Battery packs/batteries: Never throw battery packs or batteries into the household waste, fire or water. Batteries and battery packs should be collected, recycled or disposed of in an environmentally friendly manner.

TECHNICAL DATA

Transmission frequency	868,4 MHz Schellenberg
Range in the open field	up to 150 meters
Range within buildings	up to 20 meters
Power supply	3 Volt DC
Battery type	CR 2450
Protection class	IP 20
Ambient temperature	0° – 50° Celsius

GB



The structural conditions affect the range and function of the wireless timer.

LEGEND SYMBOLS

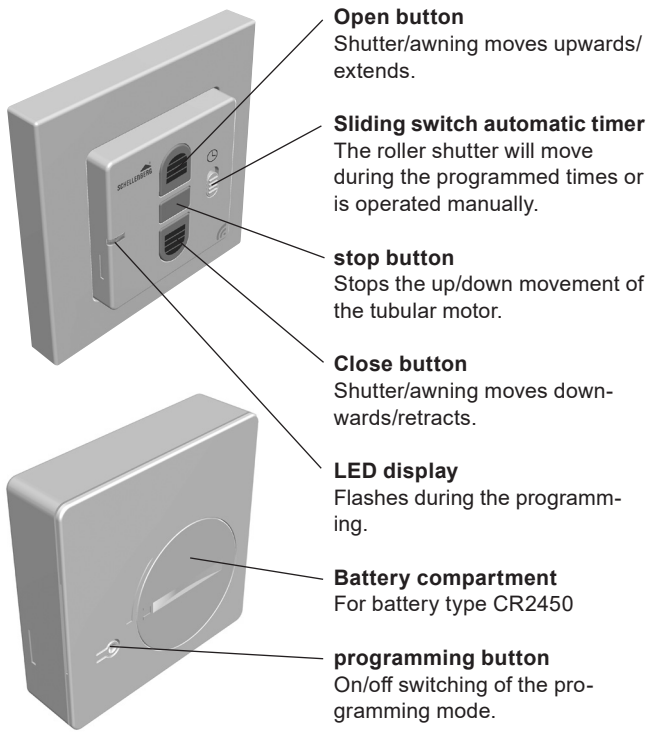

LED off



LED illuminated

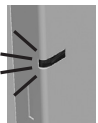

LED blinks

PAIRING WITH SMART HOME SYSTEM

GB

Pair the product with the Smart Friends System, and control all „Ready for Smart Friends“ products through the Friends app.



www.smart-friends.com

TABLE DES MATIÈRES

Sécurité et consignes	19
Caractéristiques techniques	22
Légende des symboles	23
Couplage Avec Le système smart home	24
Outils nécessaires	39
Étendue de livraison	39
A Montage	40
B Insérer la pile	42
C Moteur tubulaire : Assigner une adresse	45
D Démarrer le mode de programmation	47
E Coupler la minuterie radioélectrique au moteur tubulaire	48
F Contrôler le sens de rotation du moteur tubulaire	50
G Modifier le sens de rotation	51
H Régler le point d'extrémité supérieur	52
I Régler le point d'extrémité inférieur	54
J Quitter le mode de programmation	56
K S'approcher du point d'extrémité	57
L Coupler d'autres radioémetteurs	58
M Activer l'automatisme horaire	61
N Automatisme horaire: programmation des temps d'ouverture et de fermeture	63
O Automatisme horaire: suppression des temps d'ouverture et de fermeture	65
P Désactiver l'automatisme horaire (protection contre la fermeture avant d'être rentrée)	66
Q Supprimer la minuterie radioélectrique couplée	67
R Réinitialisation des réglages usine	71
S Régler le point intermédiaire (en option)	76
T Effacer le point intermédiaire	77
U S'approcher du point intermédiaire	79

Soumis au droit d'auteur, 2021, Alfred Schellenberg GmbH. Tous droits réservés.
Interdiction de toute utilisation non autorisée par le droit d'auteur, et notamment de la
reproduction, de la traduction, de la transformation ou de la transmission des contenus
des bases de données ou des autres médias et systèmes électroniques.

SÉCURITÉ ET CONSIGNES

Chers clients, chères clientes,



Veillez lire cette notice complètement avant le montage et la mise en service. Respectez toutes les consignes de sécurité avant de commencer les travaux. Conservez cette notice et indiquez à chaque utilisateur les éventuels dangers en liaison avec ce produit. En cas de changement de propriétaire, transmettez cette notice également au nouveau propriétaire. Pour les dommages, résultant d'une utilisation non conforme ou d'un montage incorrect, tout droit à la garantie s'éteint.

FR

CONSIGNES DE SÉCURITÉ



Danger de mort à cause d'une décharge électrique !
Avant de travailler sur les installations électriques, ces dernières doivent être mises hors tension.



- Utiliser le produit uniquement dans des locaux secs.
- Le système de volet roulant radiocommandé doit pouvoir être surveillé lors de son fonctionnement, surtout lorsque le système de volet roulant est asservi par plus d'un radioémetteur.
- Maintenez à distance les personnes du champ d'action du volet roulant. Un risque de blessure existe.
- Le produit et l'emballage ne sont pas des jouets. Tenez les enfants éloignés, un risque de blessure ou d'asphyxie existe.
- Pour l'exploitation d'une minuterie radioélectrique, il faut respecter les dispositions spécifiques au pays d'utilisation.

- Remplacez les piles exclusivement par des piles de même type, pile plate CR 2450.
- Ne pas faire passer le moteur tubulaire au-delà des positions d'extrémité. Risque d'endommagement !

UTILISATION CONFORME

- Ne raccorder le produit (Réf. 20031/20036) qu'à des appareils homologués par le fabricant.
- Toute autre utilisation ou utilisation dépassant ce cadre est considérée comme non conforme.
- Le produit ne doit pas être utilisé dans des zones où il risque de perturber de tierces personnes (dans des hôpitaux, aéroports ou autres établissements).
- D'autres installations radioélectriques édifiées et exploitées dans les normes n'y procurent aucune protection contre les perturbations. Cela s'applique en particulier aux installations conformes travaillant dans la même bande de fréquences.
- Les volets roulants commandés par le biais du produit doivent être dans un état parfait.
- L'entreprise Alfred Schellenberg GmbH ne garantit pas les dommages matériels, corporels et consécutifs résultant d'une utilisation non conforme.
- Le fonctionnement du radioémetteur portatif à proximité d'appareils à rayonnement électromagnétique ou à proximité de surfaces métalliques peut être entravé par des perturbations.
- La portée du produit est limitée du fait des directives européennes et par la législation.
- La portée du produit s'élève à environ 150 mètres sur terrain libre et à environ 20 mètres dans un bâtiment

DÉCLARATION DE CONFORMITÉ UE

La minuterie radioélectrique (réf.  20031,  20036) est conforme aux exigences applicables des directives nationales et européennes. La conformité a été prouvée. Le texte complet de la déclaration de conformité UE est disponible à l'adresse suivante : <http://www.schellenberg.de> (élément de menu « Service » dans la plateforme de téléchargement).

FR



Radio Equipment Directive 2014/53/EU (RED)
RoHS Directive 2011/65/EU



Non smaltire insieme ai rifiuti domestici! Il prodotto è riciclabile e può essere consegnato presso un centro di raccolta specializzato per rifiuti elettrici.

Piles/Batteries : Ne pas jeter les piles ou batteries avec les déchets ménagers, dans le feu ou dans l'eau. Les piles et batteries doivent être collectées, recyclées ou mises au rebut de manière non polluante.

**CARACTÉRISTIQUES
TECHNIQUES**

Fréquence de transmission	868,4 MHz Schellenberg
Portée sur terrain	jusqu'à 150 mètres
Portée un bâtiment	jusqu'à 20 mètres
Alimentation en tension	3 Volt DC
Type de batterie	CR 2450
Type de protection	IP 20
Température ambiante	0° – 50° Celsius



Les bâtiments autour du site d'utilisation sont susceptibles d'influencer la portée et le fonctionnement de la minuterie radioélectrique.

LÉGENDE DES SYMBOLES

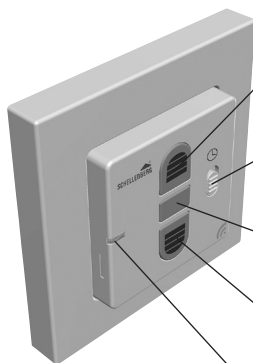

Touche Montée

Le volet roulant / le store se déplace vers le haut / sort.

Commutateur à glissière de l'automatisme horaire

Le volet roulant se déplace aux moments programmés ou doit être actionné manuellement

Touche Arrêt

Stoppe le déplacement vers le haut / vers le bas du moteur tubulaire.

Touche Descente

Le volet roulant / le store se déplace vers le bas / rentre.

Affichage à DEL

Clignote lors de la programmation.

Compartiment de batterie

Pour le type de pile CR2450.

Touche Programmation

Connexion et déconnexion du mode de programmation.

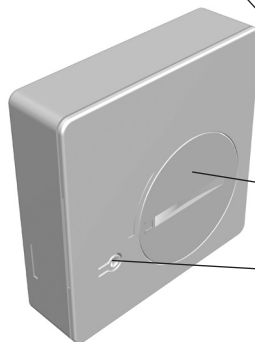

DEL
éteinte



La DEL
est éclairée

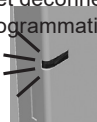

La DEL
clignote

FR

COUPLAGE AVEC LE SYSTÈME SMART HOME

Coupler le produit avec le système Smart Friends et gérer tous les produits « Ready for Smart Friends » à l'aide de l'application Friends.



www.smart-friends.com

SPIS TREŚCI

Bezpieczeństwo i wskazówki	26
Dane techniczne	29
Legenda symboli	30
Sprzężenie z systemem Smart Home	31
Wymagane narzędzia	39
Zakres dostawy	39
A Montaż	40
B Zakładanie baterii	42
C Silnik rurowy: Przydzielanie adresu	45
D Start trybu programowania	47
E Sprzężanie radiowego programatora zegarowego z silnikiem rurowym ..	48
F Sprawdzanie kierunku obrotu silnika rurowego	50
G Zmiana kierunku obrotu	51
H Ustawianie górnego położenia krańcowego	52
I Ustawianie dolnego położenia krańcowego	54
J Zakończenie trybu programowania	56
K Dosuw do pozycji końcowej	57
L Sprzężenie dodatkowych nadajników radiowych	58
M Uaktywnianie automatycznego sterowania czasowego	61
N Automatyczne sterowanie czasowe: programowanie czasu podnoszenia i opuszczania	63
O Automatyczne sterowanie czasowe: kasowanie czasu podnoszenia i opuszczania	65
P Wyłączanie automatycznego sterowania czasowego (zabezpieczenie przed uwięzieniem)	66
Q Kasowanie sprzężonych radiowych programatorów zegarowych	67
R Reset fabryczny	71
S Ustawianie pozycji pośredniej (opcja)	76
T Kasowanie pozycji pośredniej	77
U Dosuw do pozycji pośredniej	79

PL

Chronione prawami autorskimi, 2021, Alfred Schellenberg GmbH. Zabronione jest wszelkie wykorzystanie niezgodne z Ustawą o prawie autorskim, w szczególności powielanie, tłumaczenie, przetwarzanie lub przekazywanie treści w bazach danych lub na/w innych nośnikach i systemach elektronicznych.

BEZPIECZEŃSTWO I WSKAZÓWKI

Szanowna Klientko, Szanowny Kliencie



Przed montażem i uruchomieniem dokładnie przeczytaj niniejszą instrukcję. Przestrzegaj wszystkich zasad bezpieczeństwa przed przystąpieniem do pracy. Zachowaj tę instrukcję oraz informuj każdego użytkownika o ewentualnych zagrożeniach związanych z używaniem produktu. Przy każdej zmianie właściciela przekaż niniejszą instrukcję nowemu właścicielowi. W przypadku szkód spowodowanych przez użytkowanie w nienależyty sposób lub nieprawidłowy montaż wygasa gwarancja i wszelkie roszczenia gwarancyjne.

ZASADY BEZPIECZEŃSTWA



Niebezpieczeństwo śmierci wskutek porażenia elektrycznego! Przed przystąpieniem do prac na instalacji elektrycznej odłącz ją od napięcia.

- Używaj produktu tylko w pomieszczeniach suchych
- Instalacja roletowa sterowana radiowo musi być widoczna podczas pracy, zwłaszcza jeżeli jest wysterylizowana przez więcej niż jeden ręczny pilot radiowy.
- Ludzie nie mogą przebywać w strefie przesuwu rolety. Niebezpieczeństwo obrażeń.
- Produkt i opakowanie nie mogą być używane do zabawy. Przechowuj je poza zasięgiem dzieci, niebezpieczeństwo obrażeń lub uduszenia.

- Przy eksploatacji radiowego programatora zegarowego muszą być przestrzegane odnośne przepisy krajowe.
- W razie wymiany stosuj tylko baterie tego samego typu, bateria płaska CR 2450.
- Nie dopuszczaj do przesuwu silnika rurowego poza położenia krańcowe. Grozi to uszkodzeniem!

UŻYCIE ZGODNE Z PRZEZNACZENIEM

PL

- Produkt (Nr Art. 20031/20036) można łączyć tylko z urządzeniami, które są do tego dopuszczone przez producenta.
- Inne lub wykraczające poza powyższe użytkowanie jest uważane za niezgodne z przeznaczeniem.
- Produktu nie wolno używać w strefach wysokiego ryzyka lub zaburzeń osób trzecich (np. w szpitalach, na lotniskach i podobnych obiektach).
- Urządzenie nie ma żadnej ochrony przed zakłóceniami spowodowanymi przez inne należycie zbudowane i użytkowane urządzenia radiowe. Zwłaszcza przez prawidłowo działające urządzenia, pracujące w tym samym zakresie częstotliwości.
- Instalacje roletowe sterowane przez produkt muszą znajdować się w nienagannym stanie.
- Alfred Schellenberg GmbH nie odpowiada za szkody następcze, szkody materialne i osobowe, spowodowane użyciem niezgodnym z przeznaczeniem.
- Używanie ręcznego pilota radiowego w pobliżu urządzeń emitujących promieniowanie magnetyczne lub posiadających powierzchnie metalowe ma negatywny wpływ na jego prawidłowe działanie.
- Zasięg ręcznego produktu jest ograniczony przez rozporządzenia europejskie i dyrektywy Ustawodawcy.
- Zasięg produktu wynosi ok. 150 metrów na wolnej przestrzeni i ok. 20 metrów w budynku.

DEKLARACJA ZGODNOŚCI UE

Radiowego sterownika zegarowego (nr art. (DE) 20031, (DE) 20036) spełnia obowiązujące wymogi określone normami europejskimi i krajowymi. Zgodność została udokumentowana. Cały tekst deklaracji zgodności UE jest dostępny pod adresem: <http://www.schellenberg.de> (punkt menu „Service” w zakładce z materiałami do pobrania).



Radio Equipment Directive 2014/53/EU (RED)
RoHS Directive 2011/65/EU



Nie wyrzucać wraz z odpadami domowymi! Produkt nadaje się do recyklingu i można go oddać do zakładu recyklingowego lub do punktu zbiórki złomu elektrycznego.

Akumulatory/baterie: Nie wyrzucaj akumulatorów ani baterii do domowego śmietnika, do ognia ani wody. Akumulatory i baterie należy zbierać, oddawać do recyklingu lub utylizować w sposób przyjazny dla środowiska.

DANE TECHNICZNE

Częstotliwość transmisji	868,4 MHz Schellenberg
Zasięg na wolnej przestrzeni	do 150 metrów
Zasięg w budynku	do 20 metrów
Zasilanie napięciowe	3 Volt DC
Typ baterii	CR 2450
Stopień ochrony	IP 20
Temperatura otoczenia	0° – 50° Celsius

PL



Warunki budowlane mogą mieć negatywny wpływ na zasięg i działanie radiowego programatora zegarowego.

LEGENDA SYMBOLI

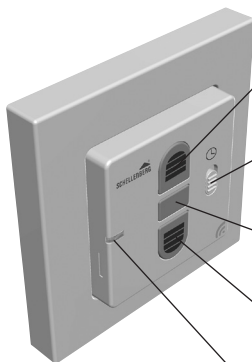

Przycisk podnoszenia

Roleta/markiza przesuwa się do góry/wysuwa się.

Przełącznik suwakowy sterowania czasowego

Roleta przesuwa się w zaprogramowanych porach lub jest obsługiwana ręcznie.

Przycisk stop

Zatrzymuje jazdę do góry i na dół silnika rurowego.

Przycisk opuszczania

Roleta/markiza przesuwa się do dołu/wsuwa się.

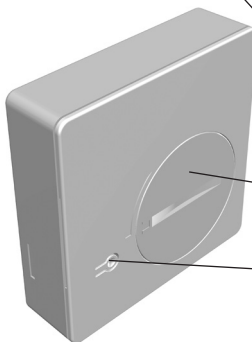

Wskaźnik LED

Miga w trakcie programowania.

Schowek na baterie

Do baterii typu CR2450.

Przycisk programowania

Włączanie i wyłączanie trybu programowania.



LED
wył.



LED
świeci



LED
miga

SPRZĘŻENIE Z SYSTEMEM SMART HOME

Produkt można skojarzyć z systemem Smart Friends i sterować wszystkimi produktami „Ready for Smart Friends” razem przez aplikację Friends.



PL



www.smart-friends.com

INDICE

Sicurezza ed avvertenze	33
Dati tecnici	36
Legenda dei simboli	37
Accoppiamento sistema smart home	38
Utensili necessari	39
Fornitura	39
A Montaggio	40
B Inserire la batteria	42
C Motore tubolare: Assegnazione indirizzo	45
D Avvio modo di programmazione	47
E Collegamento del timer via radio con il motore tubolare	48
F Verifica del senso di rotazione del motore tubolare	50
G Modifica del senso di rotazione	51
H Regolazione del finecorsa superiore	52
I Regolazione del finecorsa inferiore	54
J Fine del modo di programmazione	56
K Raggiungimento del finecorsa	57
L Accoppiamento degli altri trasmettitori via radio	58
M Attivazione dell'automatismo a tempo	61
N Automatismo a tempo: programmazione del tempo di salita e discesa	63
O Automatismo a tempo: cancellazione del tempo di salita e discesa	65
P Disattivazione dell'automatismo a tempo (sicurezza per non chiudersi fuori)	66
Q Cancellazione del timer via radio accoppiato	67
R Reset impostazioni	71
S Impostazione della posizione intermedia (optional)	76
T Cancellazione della posizione intermedia	77
U Raggiungimento della posizione intermedia	79

Protetto da copyright, 2021, Alfred Schellenberg GmbH. Tutti i diritti riservati. È vietato qualsiasi tipo di utilizzo diverso da quello previsto dai diritti d'autore, in particolare la copia, la traduzione, l'elaborazione o la trasmissione dei contenuti in database o altri strumenti elettronici e sistemi.

SICUREZZA ED AVVERTENZE

Gentile cliente,



prima di procedere al montaggio e all'utilizzo dell'apparecchio si prega di leggere attentamente le istruzioni. Rispettare tutte le avvertenze prima di procedere con i lavori. Conservare le istruzioni ed informare eventuali utenti sui rischi correlati all'uso del presente prodotto. In caso di cambio di proprietà, consegnare le presenti Istruzioni al nuovo proprietario. In caso di danni causati da un uso improprio o da un montaggio errato, si estingue la garanzia e qualsiasi diritto di garanzia.

IT

AVVERTENZE DI SICUREZZA



Rischio mortale a causa di scosse elettriche!
Prima di qualsiasi intervento su impianti elettrici, è necessario scollegare sempre la rete elettrica.

- Usare il prodotto solo in ambienti asciutti.
- L'avvolgibile a controllo radio durante il funzionamento deve essere visibile, in particolare quando l'avvolgibile è controllato da più trasmettitori radio.
- Tenere lontano le persone dall'area di spostamento dell'avvolgibile. Esiste il pericolo di lesioni.
- Il prodotto e l'imballaggio non sono un giocattolo. Tenere lontano dalla portata dei bambini. Sussiste il rischio di lesioni o di soffocamento.
- Per il funzionamento del timer via radio è necessario rispettare tutte le norme nazionali.

- Sostituire le batterie con batterie dello stesso tipo, batteria piatta CR 2450.
- Non far oltrepassare il motore tubolare oltre i fincorsa. Rischio danneggiamento!

USO CONFORME

- Collegare il prodotto (N. Art. 20031/20036) solo con apparecchi autorizzati dal produttore.
- Un impiego diverso o che non rientri in quello previsto del prodotto non è considerato conforme.
- Il prodotto non deve essere utilizzato in ambienti con un rischio elevato di interferenza verso terzi (ad es. ospedali, aeroporti o strutture simili).
- Non sussiste alcuna protezione da interferenze a causa di altri impianti radio realizzati ed usati a regola d'arte. In particolare ad opera di impianti a regola d'arte che operano sulla stessa frequenza.
- Gli avvolgibili controllati dal prodotto devono trovarsi in uno stato perfetto.
- La Alfred Schellenberg GmbH non si assume alcuna responsabilità per danni conseguenti, danni a persone e cose nel caso di un impiego diverso rispetto a quello previsto.
- L'utilizzo del trasmettitore radio manuale vicino ad apparecchi con radiazione magnetica o superfici metalliche pregiudica il corretto funzionamento.
- La portata del prodotto è limitata dalle regolamentazioni e direttive europee del legislatore.
- La portata del prodotto è di ca. 150 metri all'aperto e di ca. 20 metri in immobili.

DICHIARAZIONE DI CONFORMITÀ UE

Del timer via radio (cod. art.  20031,  20036) soddisfa i requisiti in vigore delle direttive europee e nazionali.

La conformità è stata comprovata. Il testo completo della dichiarazione di conformità UE è disponibile al seguente indirizzo: <http://www.schellenberg.de> (voce menu "Service" nel Centro download).



Radio Equipment Directive 2014/53/EU (RED)
RoHS Directive 2011/65/EU



Non smaltire insieme ai rifiuti domestici! Il prodotto è riciclabile e può essere consegnato presso un centro di raccolta specializzato per rifiuti elettrici.

IT

Batteria ric./batterie: Non gettare le batterie ricaricabili o normali fra i rifiuti domestici, nel fuoco o in acqua. Le batterie ricaricabili e normali si devono raccogliere, riciclare o smaltire nel rispetto dell'ambiente.

DATI TECNICI

Frequenza di trasmissione	868,4 MHz Schellenberg
Portata all'aperto	fino a 150 metri
Portata nell'edificio	fino a 20 metri
Alimentazione della tensione	3 Volt DC
Tipo batterie	CR 2450
Tipo di protezione	IP 20
Temperatura ambiente	0° – 50° Celsius



Le costruzioni presenti possono pregiudicare la portata e il funzionamento del timer via radio.

LEGENDA DEI SIMBOLI

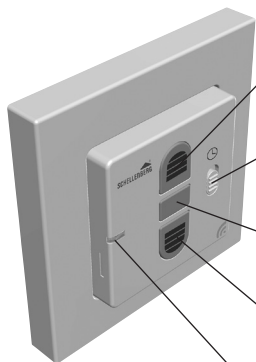

Tasto Salita

L'avvolgibile / marquise si sposta verso l'alto / esterno.

Selettore scorrevole automatismo a tempo

L'avvolgibile si attiva a orari programmati oppure viene azionato manualmente.

Tasto Stop

Arresta lo spostamento in salita / discesa del motore tubolare.

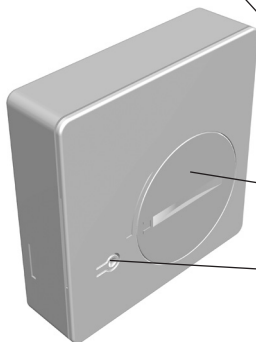

Tasto Discesa

L'avvolgibile / marquise si sposta verso il basso / interno.

Indicatore LED

Lampeggia durante la programmazione.

Scomparto batterie

Per il tipo di batteria CR2450.

Tasto Programmazione

Attivazione e disattivazione del modo di programmazione.



LED
spento



LED
acceso



LED
lampeggiante

IT

ACCOPIAMENTO SISTEMA SMART HOME

Collegare il prodotto con il sistema Smart Friends e controllate tra loro tutti i prodotti „Ready for Smart Friends“ tramite l'applicazione Friends.



www.smart-friends.com



1x

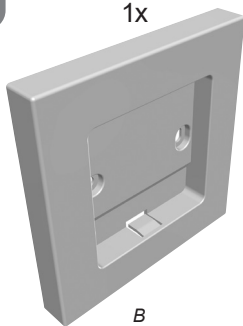

B

1x



A

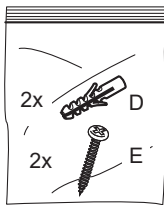

2x



D

2x



E

1x



C

A

1.

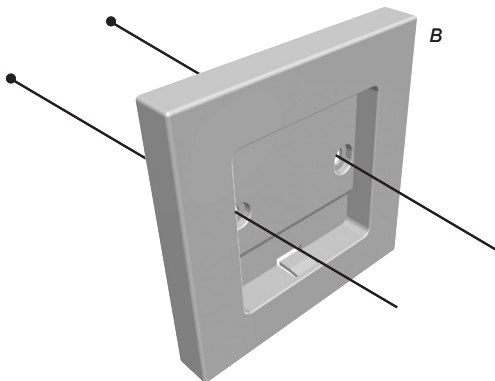

2.

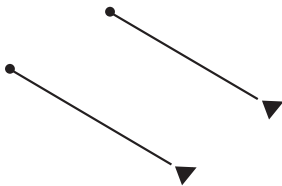

3.

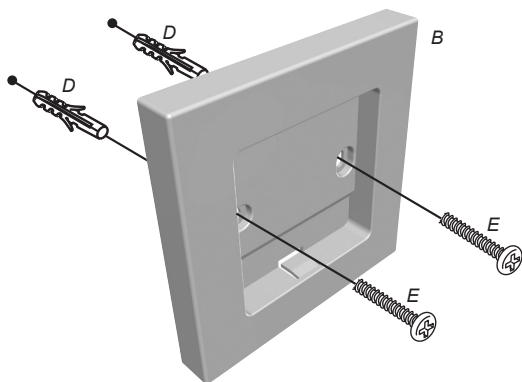

4.

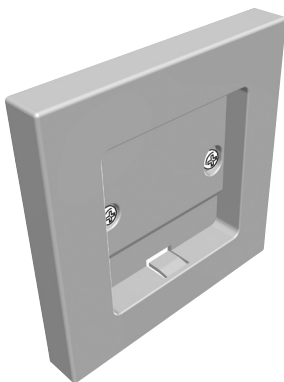

B

5.



6.

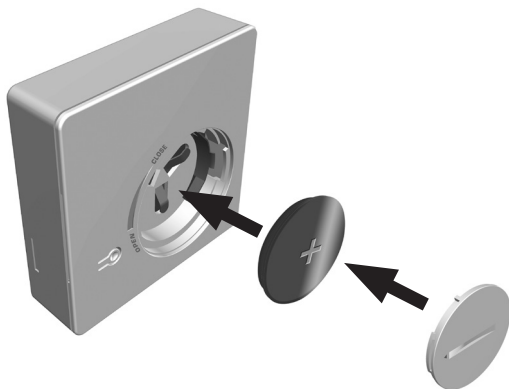

7.



8.

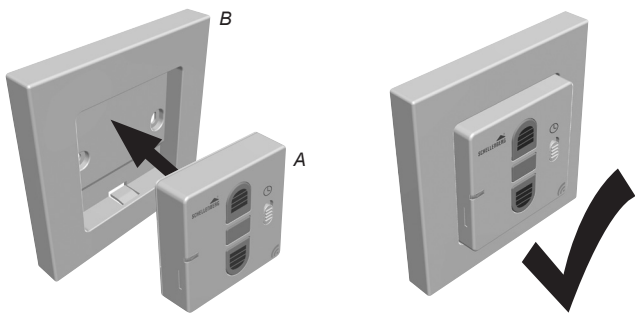

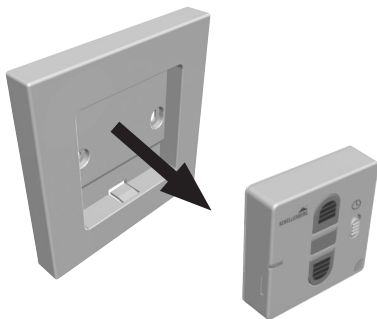
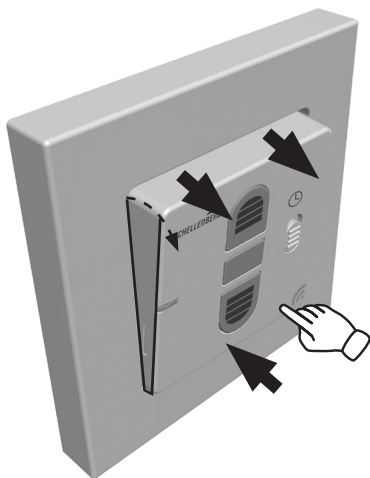

C

9.

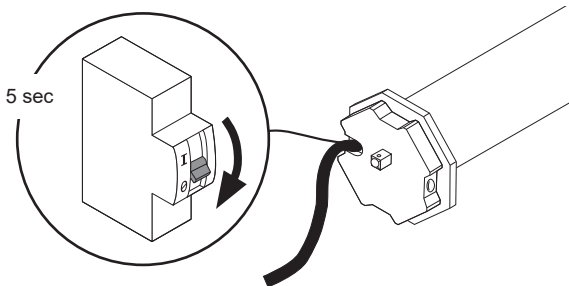

10.

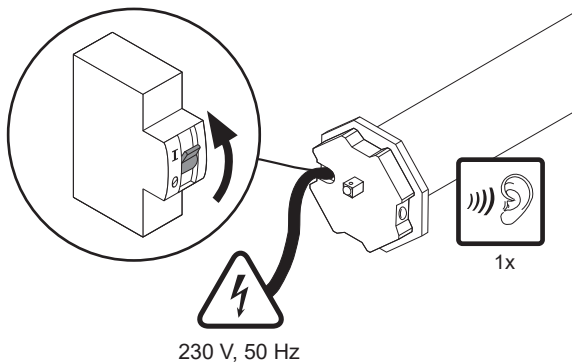

11.

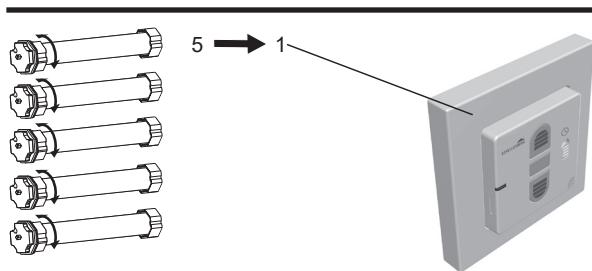
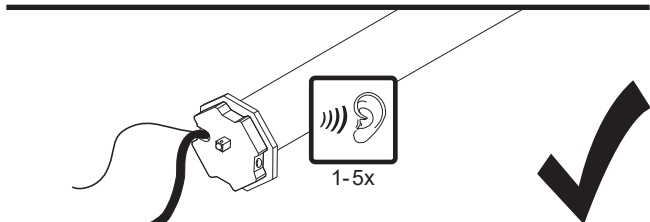
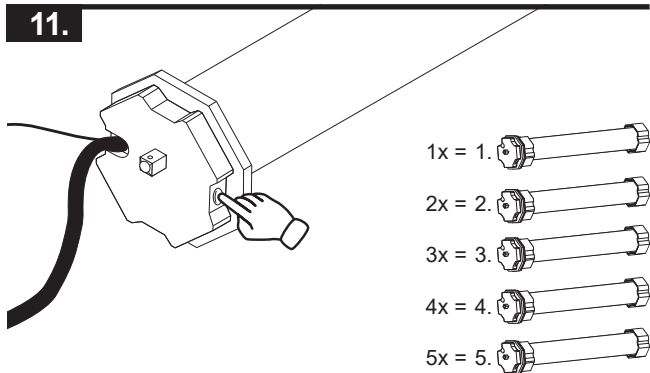

D



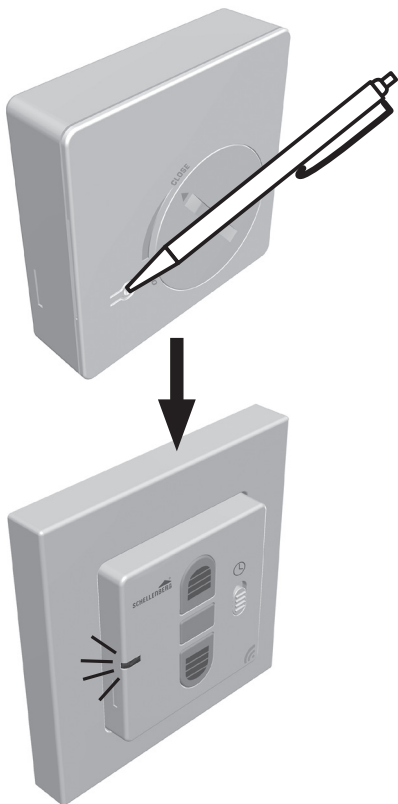

12.

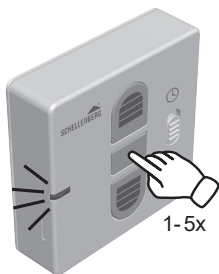

E

13.



- 1x = 1. 
- 2x = 2. 
- 3x = 3. 
- 4x = 4. 
- 5x = 5. 

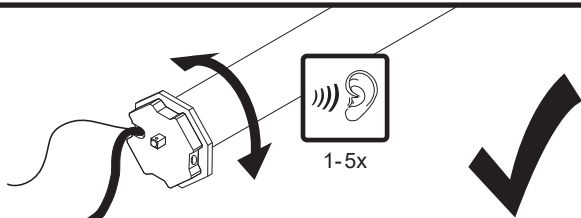

14.



15.

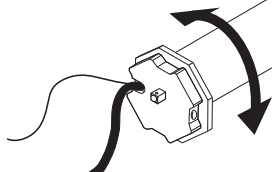
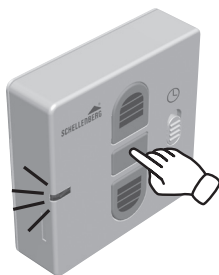

F

16.

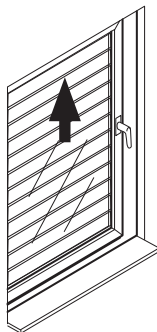
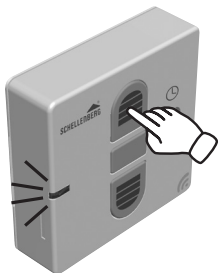

G

17.

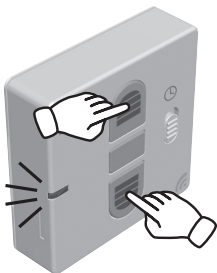

18.

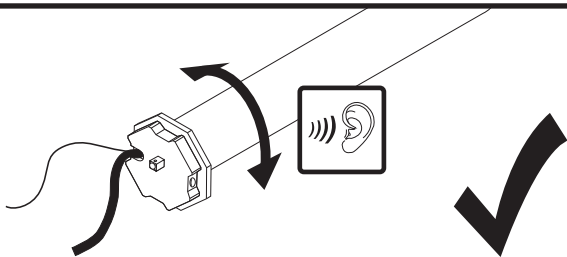
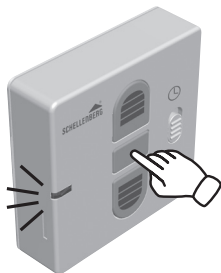

H

19.

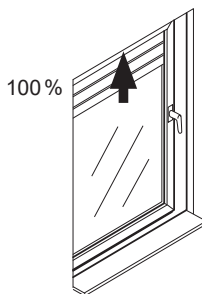
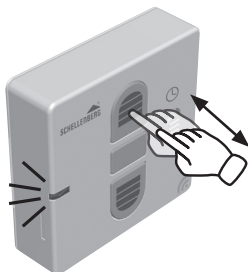
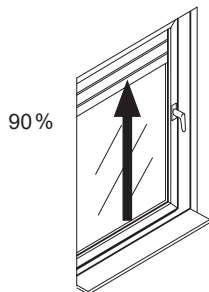
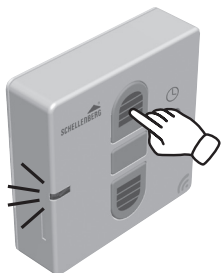

20.



21.

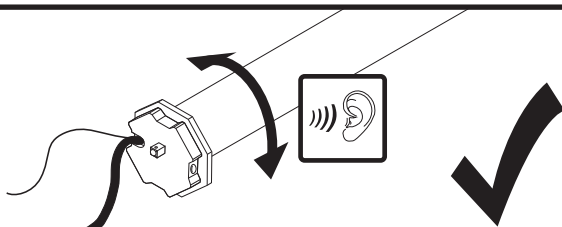
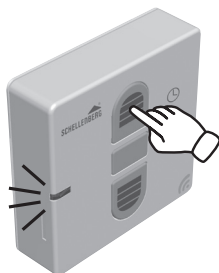

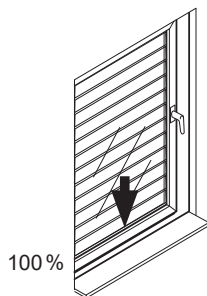
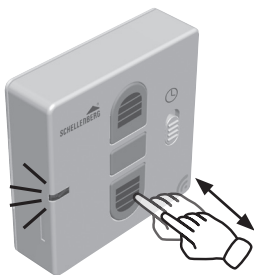
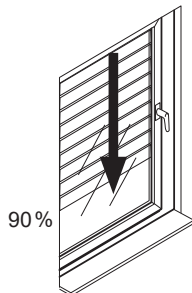

23.

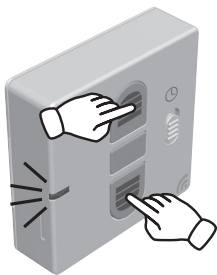

24.

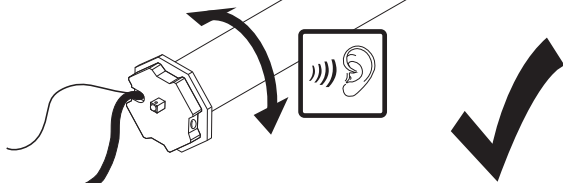

J

25.

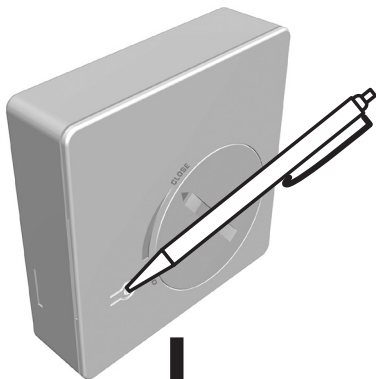

K

26.

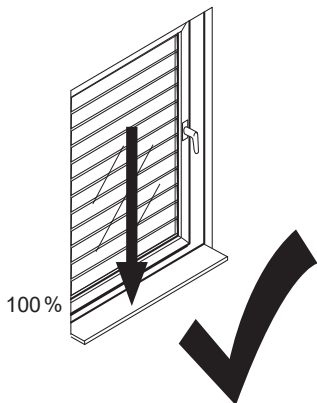
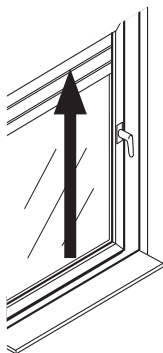
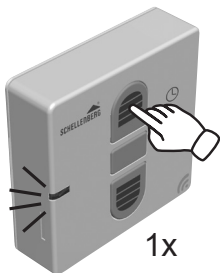

L

27.

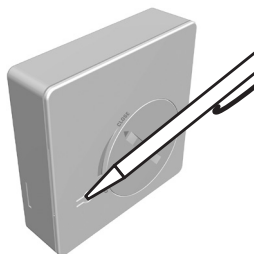

1

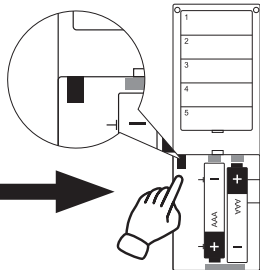

2



max.



28.

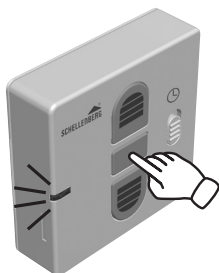

1

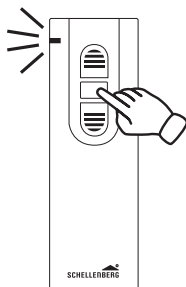

2

1 2 3 4 5
sec

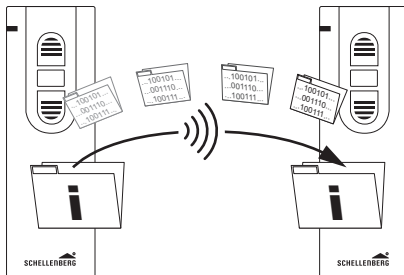

1

2

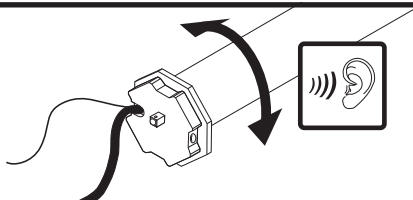

29.



1

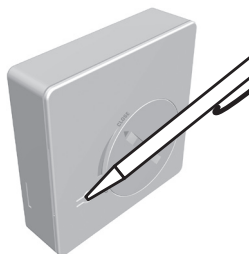

2

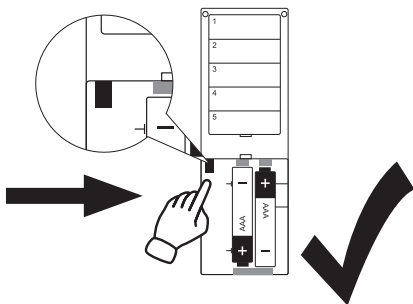

M

30.

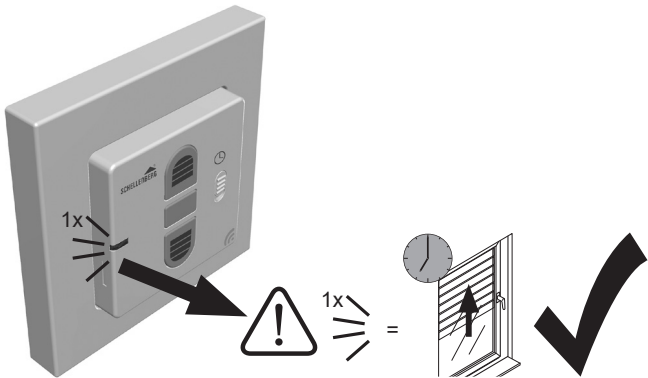
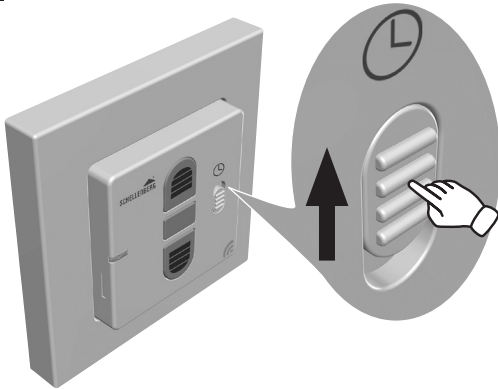

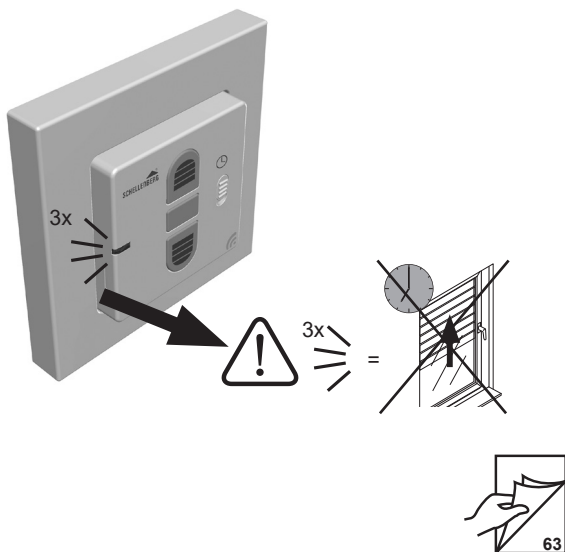

N

31.

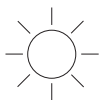
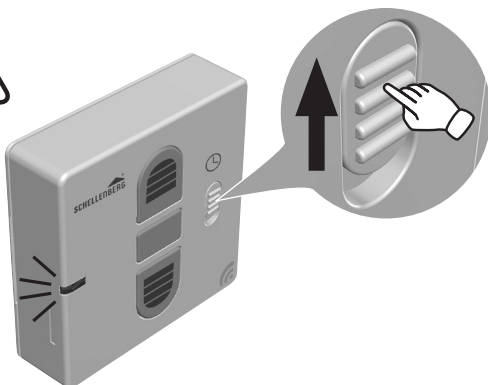

z.B.

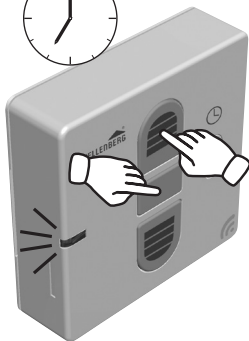

1x/24 h

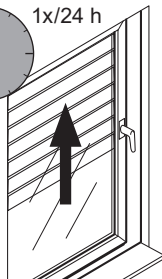

32.



z.B.

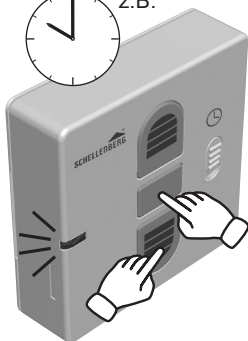

1x/24 h

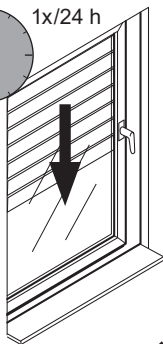

O

33.

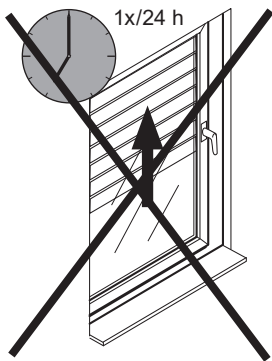
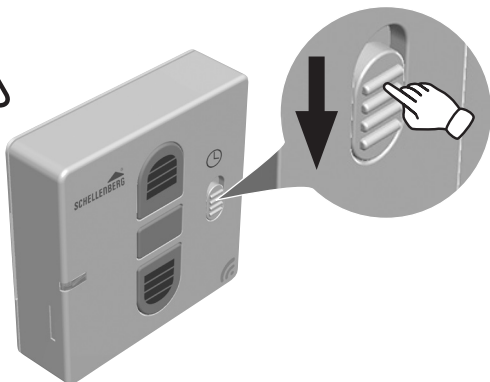

34.

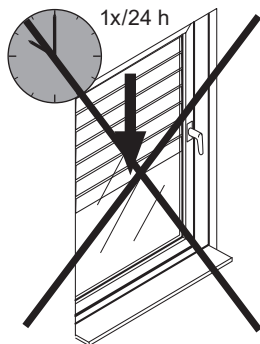
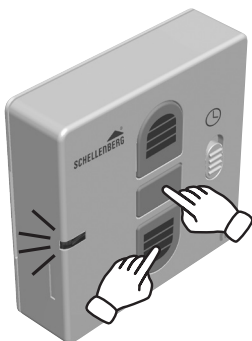

P

35.

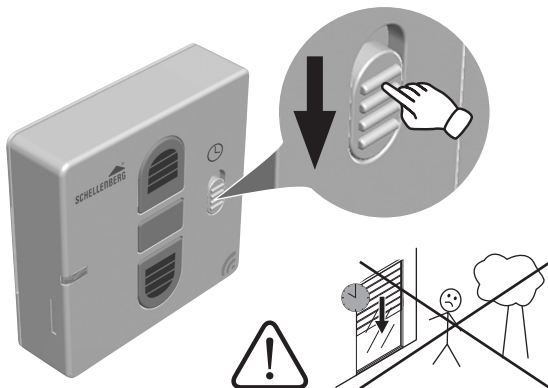

Q

36.

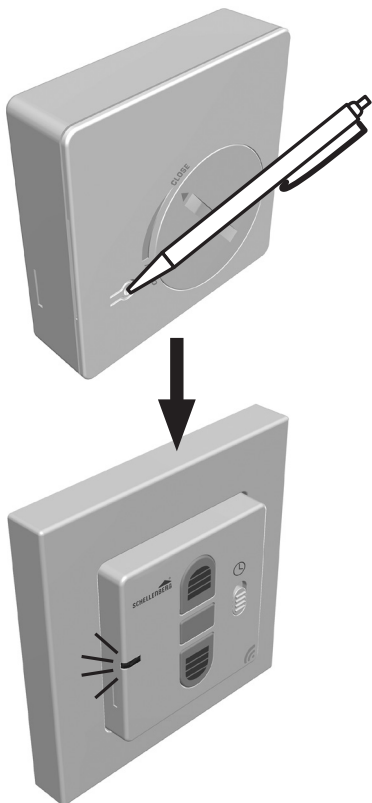

37.

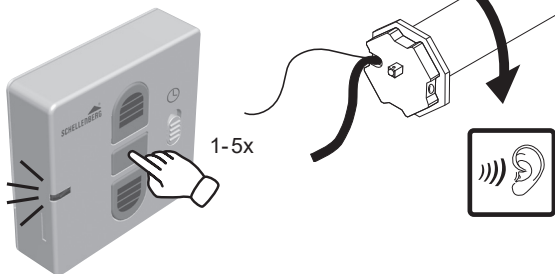

38.

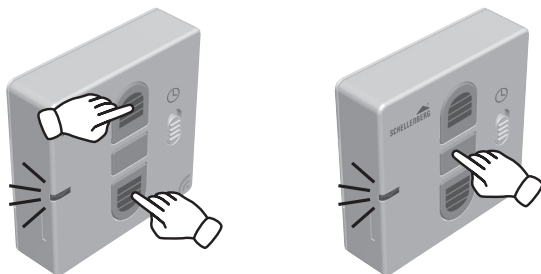

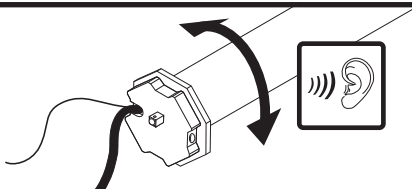
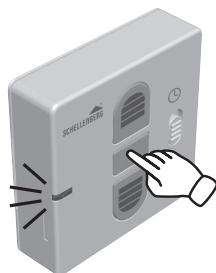
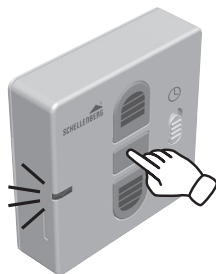
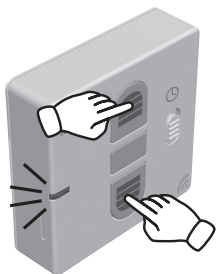

39.

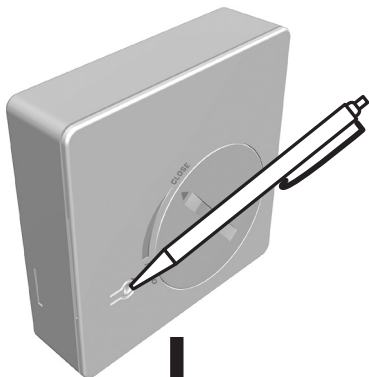

R

40.

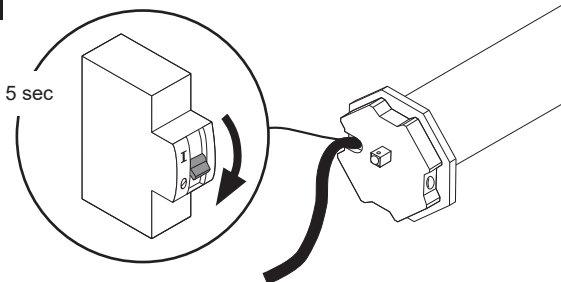

41.

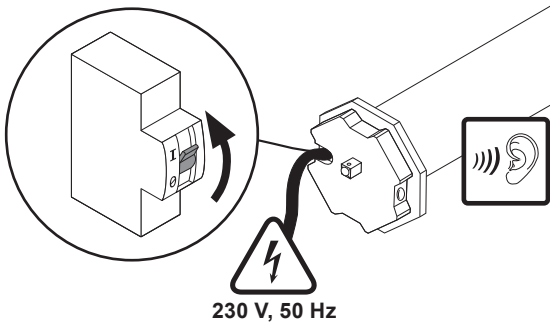

1-11.



12-30.





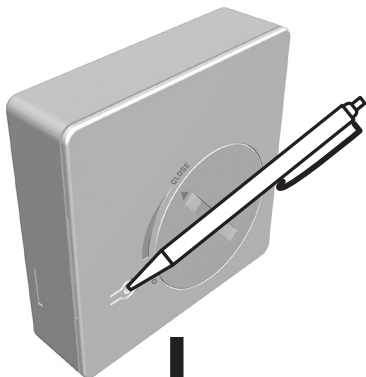

42.

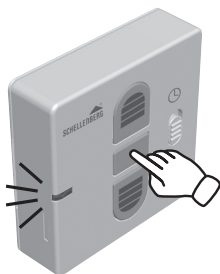

43.



- 1x = 1. 
- 2x = 2. 
- 3x = 3. 
- 4x = 4. 
- 5x = 5. 

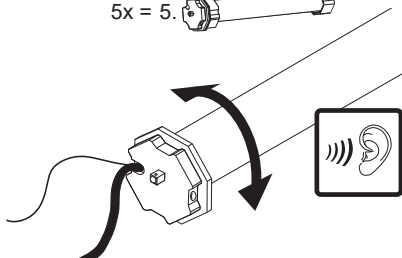

44.

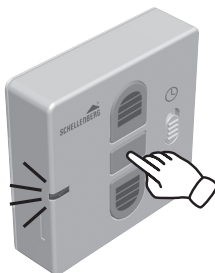

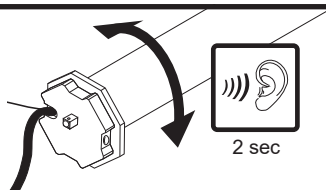
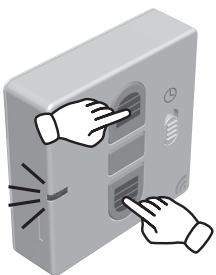
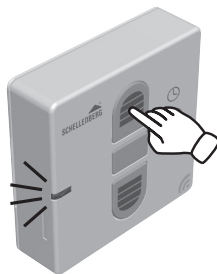
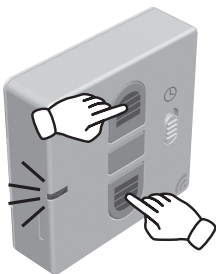

45.

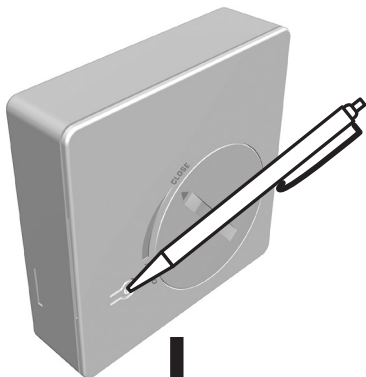

S

46.

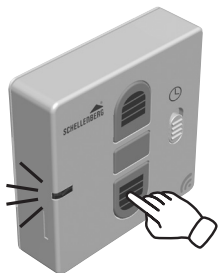

z.B. 60%

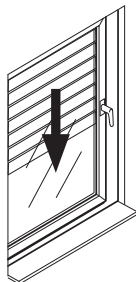

47.

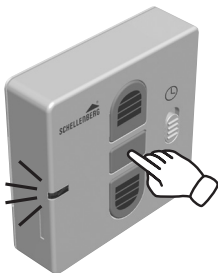

48.

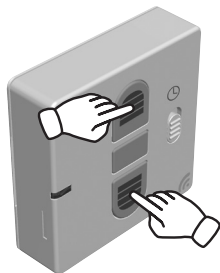

49.

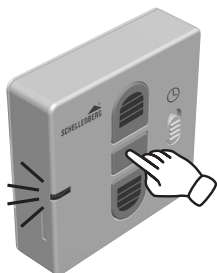

50.

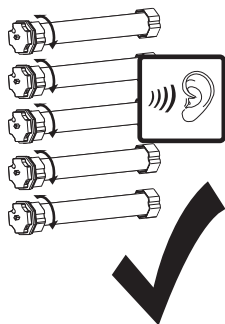

T

51.

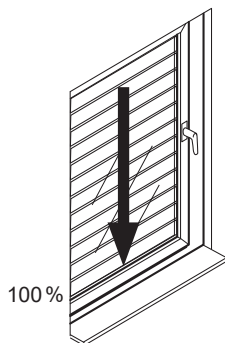

52.

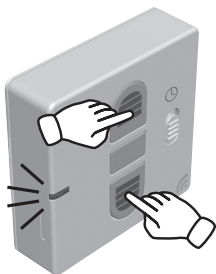

53.

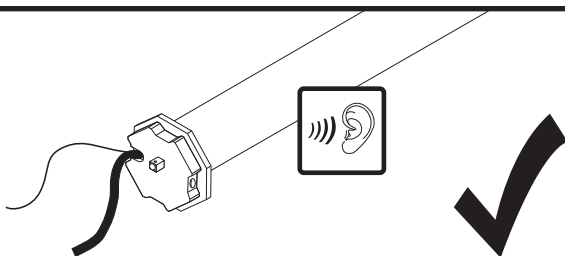
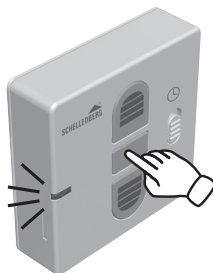

U

54.

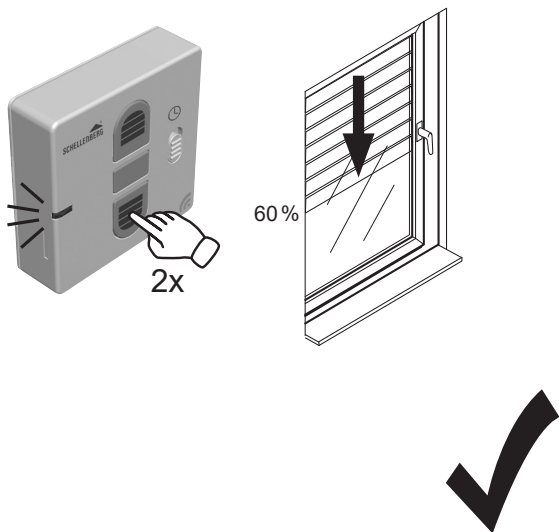



- DE** Bei Garantie, Ersatzteilbedarf oder Fragen rund um die sachgemäße Montage Ihres Produktes, wenden Sie sich bitte an unseren Kunden-Service.
service@schellenberg.de
- GB** For warranty claims, spare parts requests or questions regarding the proper installation of your product, please contact our Consumer Service Department.
service.int@schellenberg.de
- FR** Pour ce qui est des revendications de garantie, si vous avez besoin de pièces de rechange ou si vous avez des questions relatives au montage de votre produit, veuillez contacter notre service après-vente.
service.int@schellenberg.de
- PL** W razie roszczeń gwarancyjnych, zapotrzebowania na części zamienne lub pytań dotyczących prawidłowego montażu produktu należy zwrócić się do naszego serwisu.
service.int@schellenberg.de
- IT** Per la garanzia, pezzi di ricambio o informazioni sulle operazioni di montaggio corrette del prodotto, si prega di contattare il servizio di assistenza clienti.
service.int@schellenberg.de



Alfred Schellenberg GmbH

An den Weiden 31
57078 Siegen
www.schellenberg.de