

"Schutzzeichen nach DIN ISO 8859 beachten" "Please pay attention to copyright note DIN ISO 8859"

A-A (1 : 2)

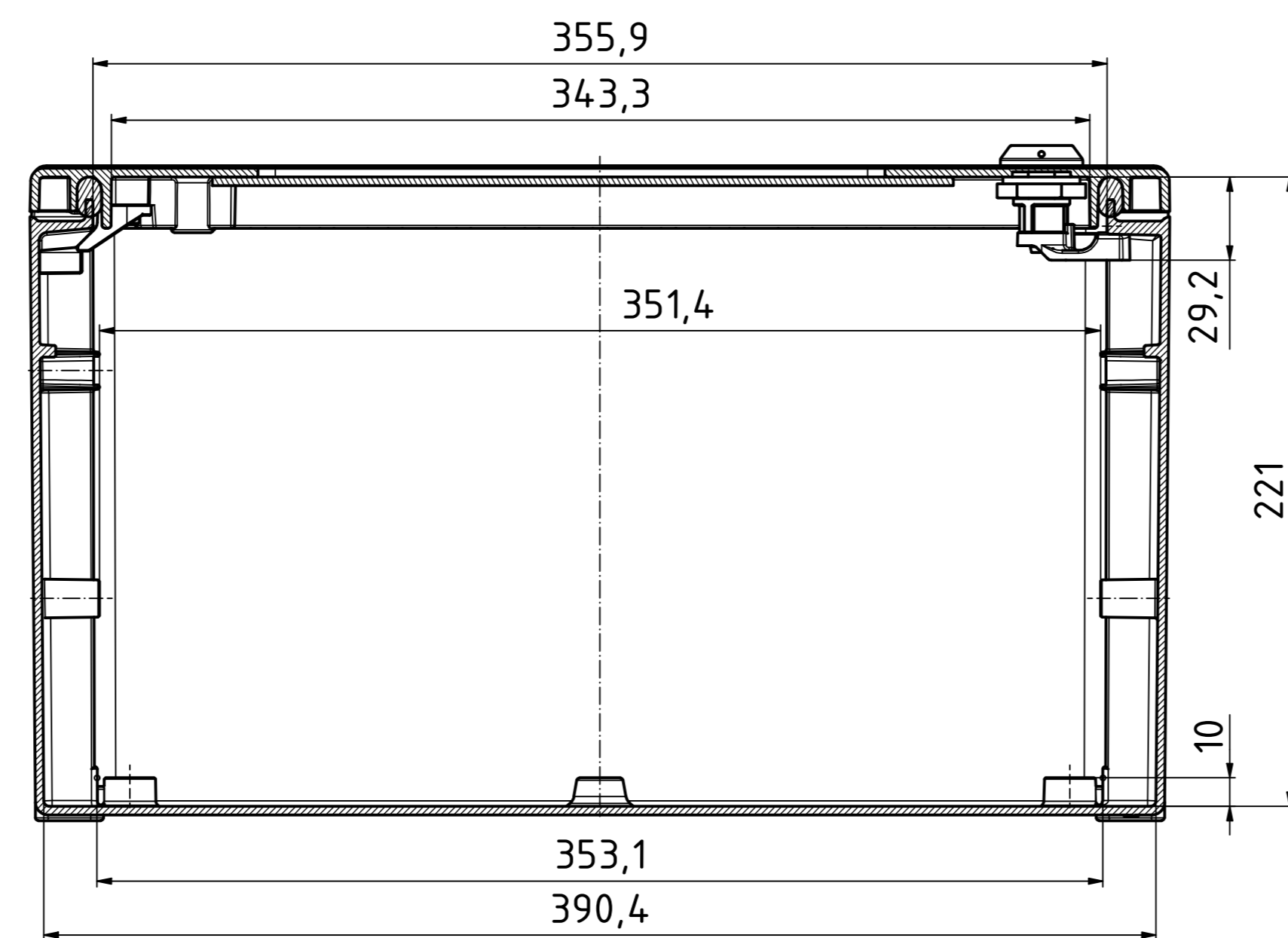

B-B (1 : 2)

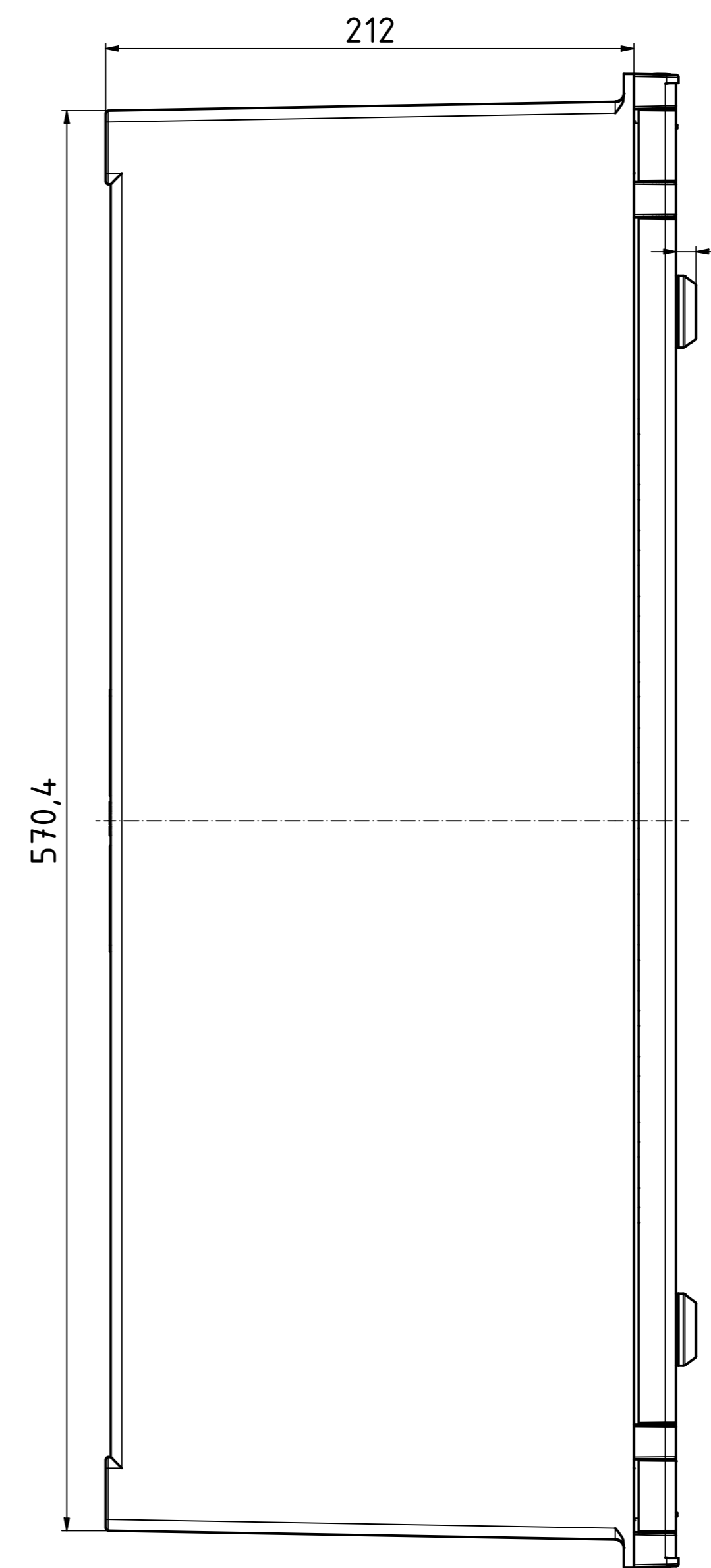
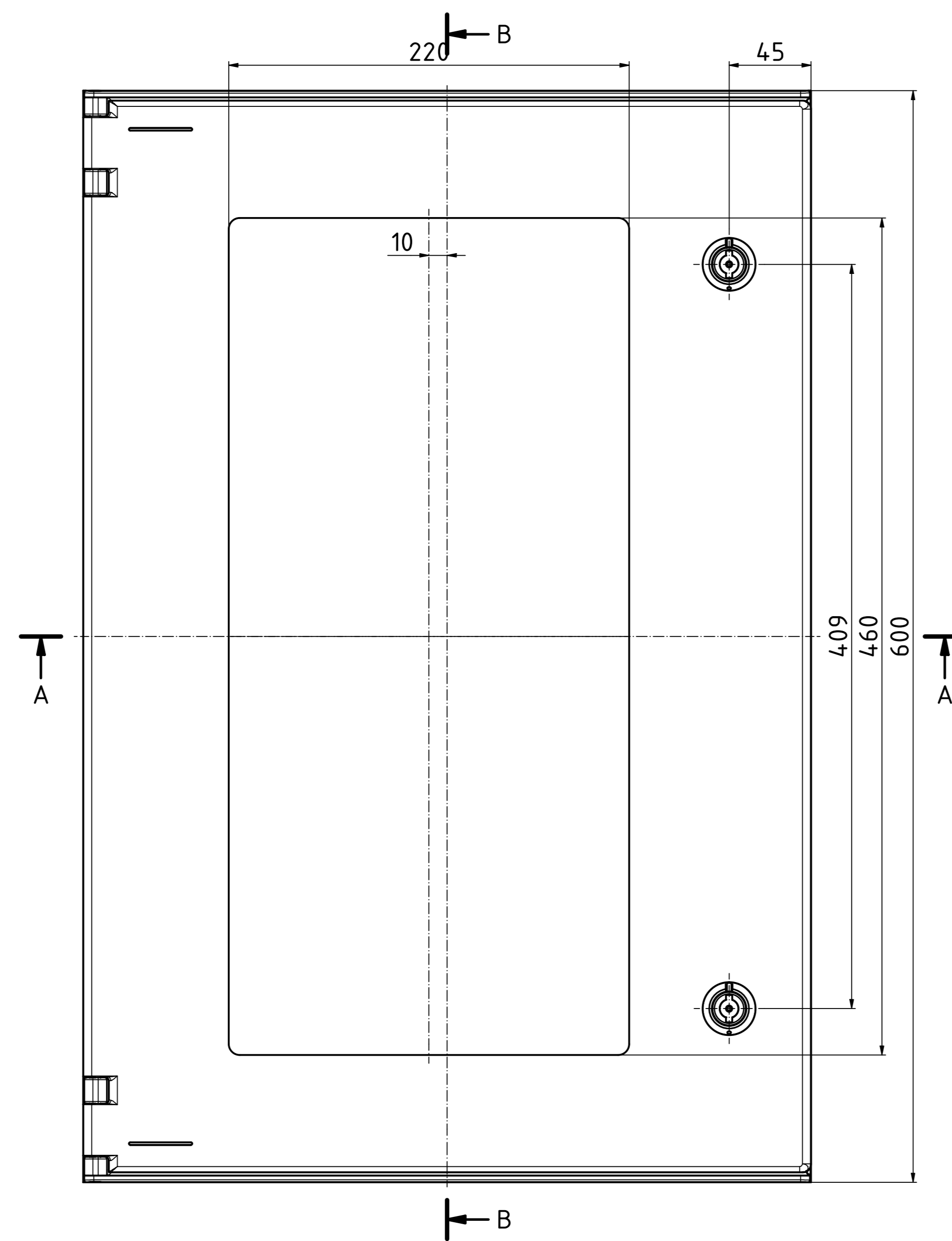
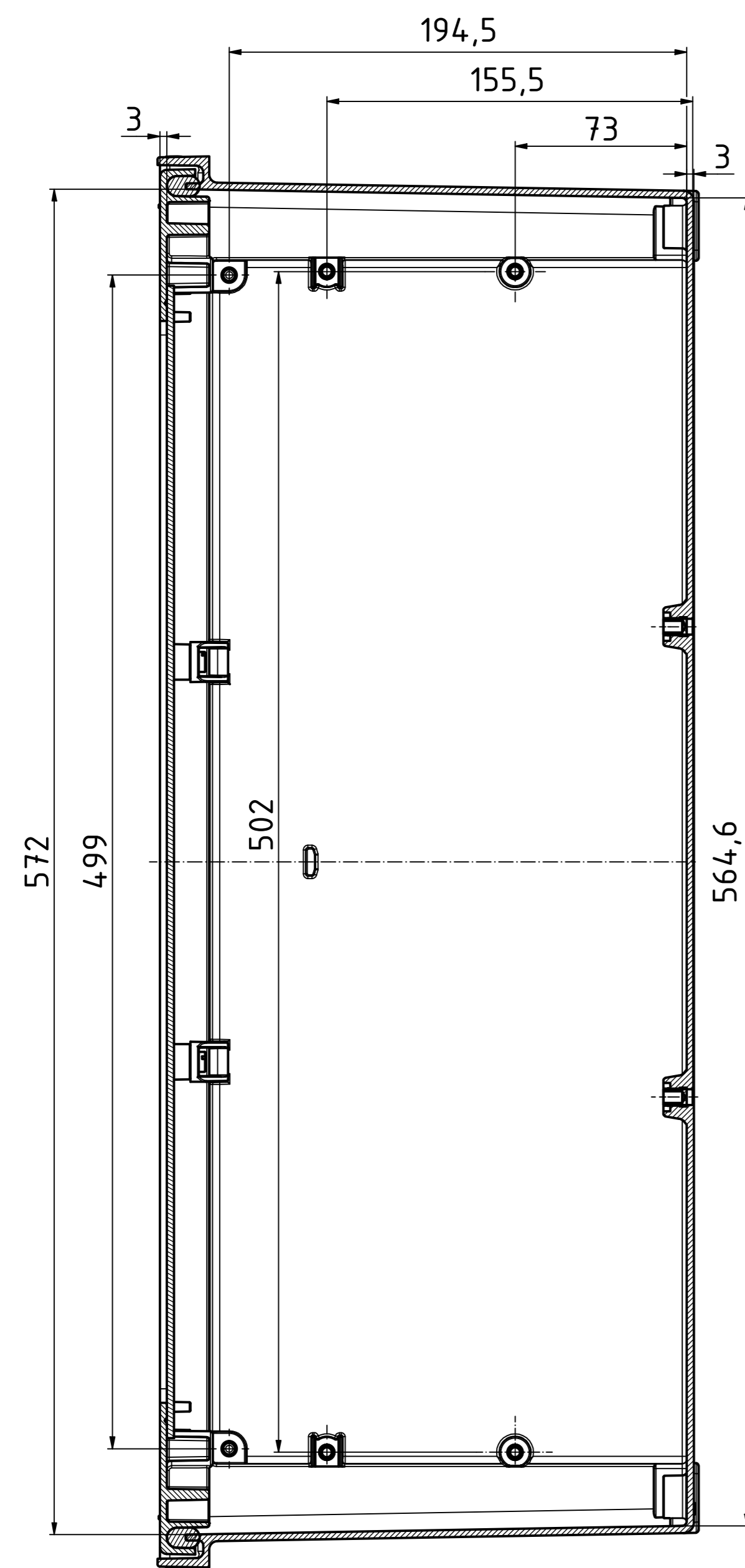

Unterseite/base (1 : 2)

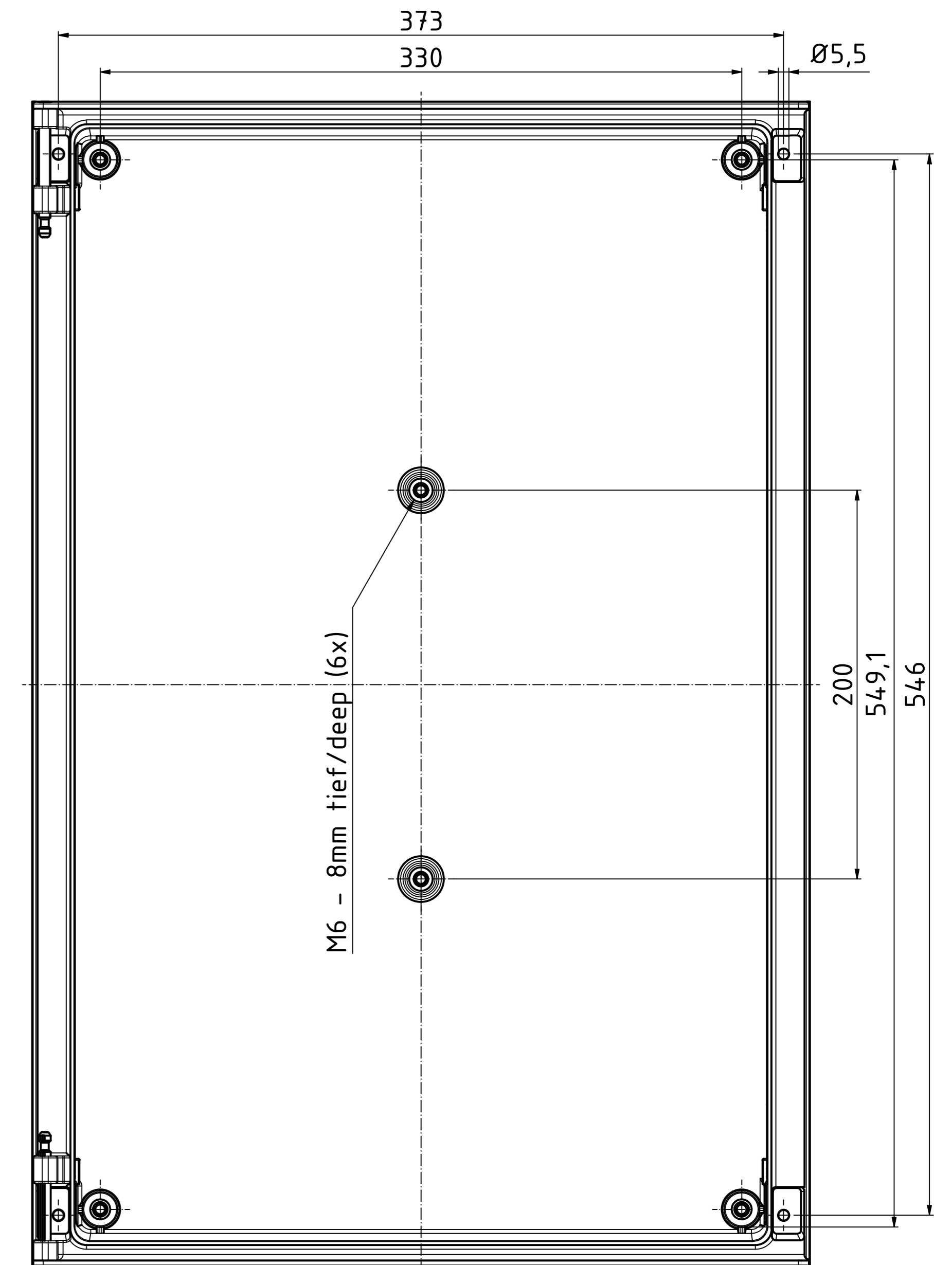

ISO (1 : 5)

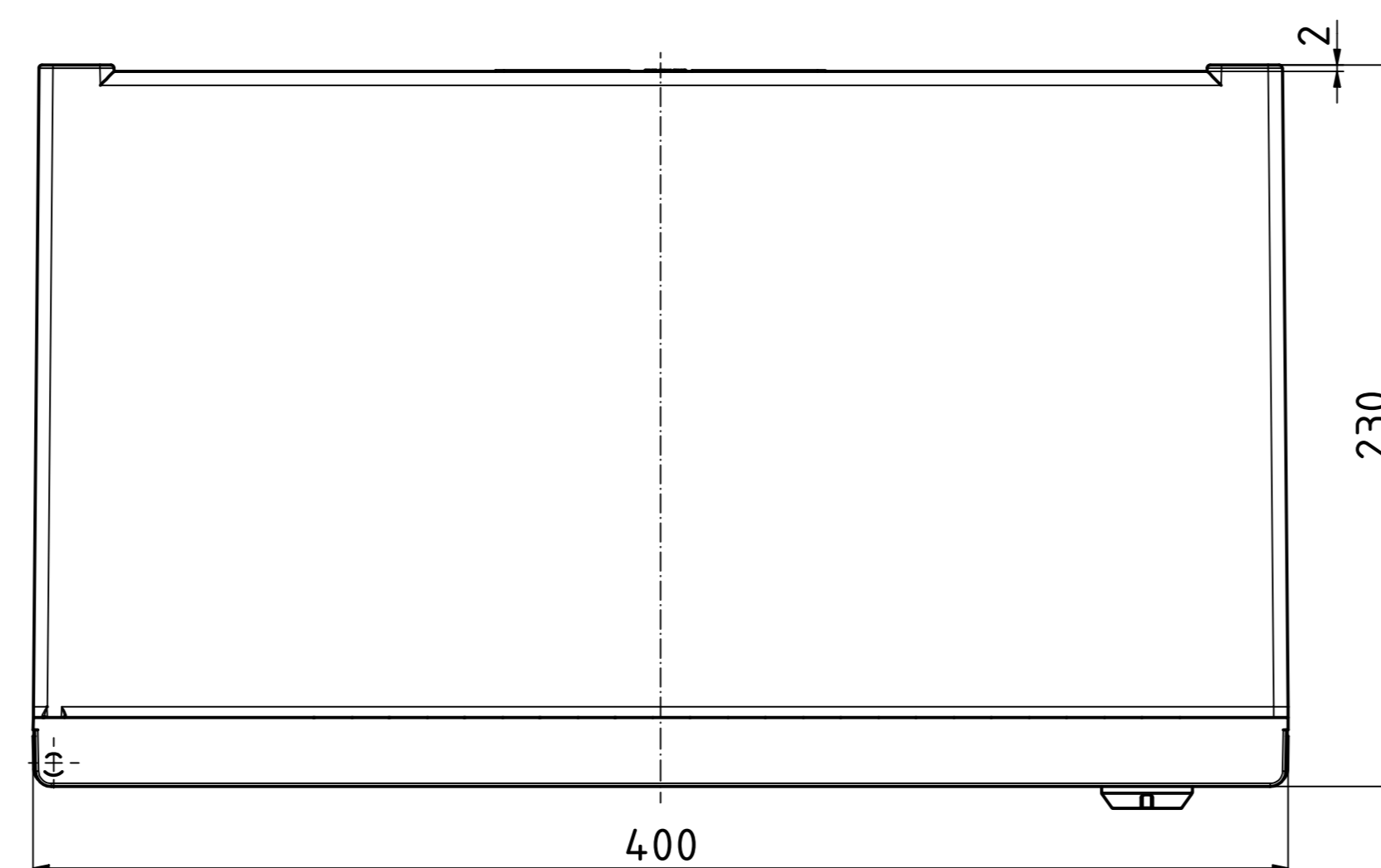
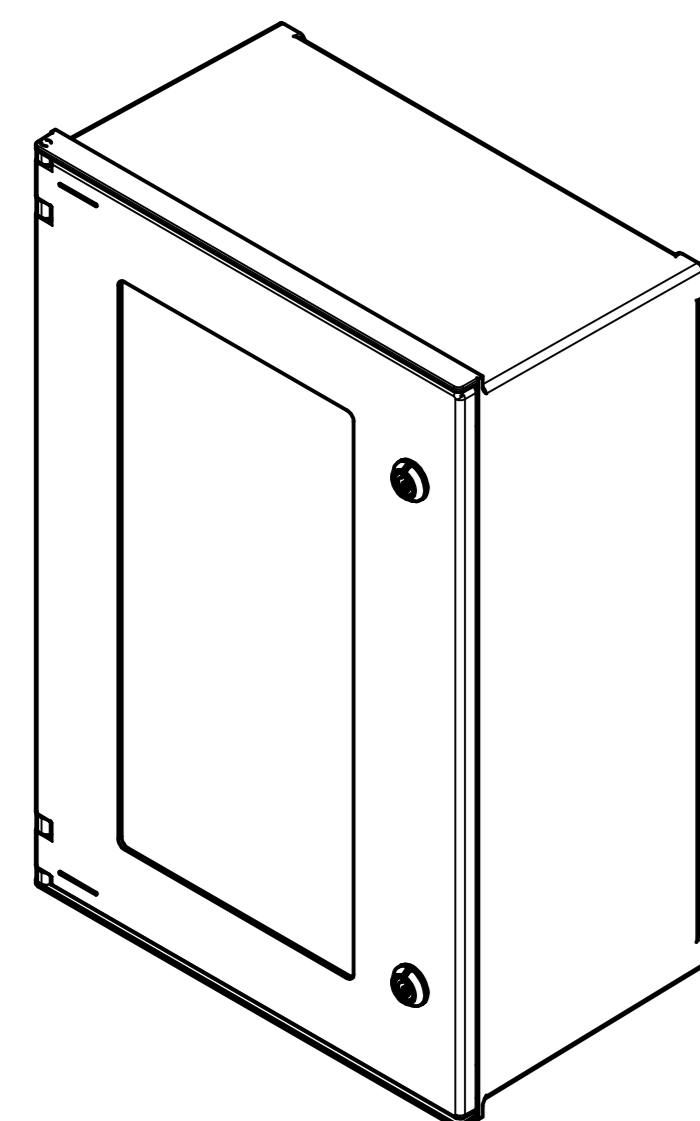

**Toleranzen für die Gehäusebauteile
nach DIN 16901-140**
*Tolerances for the enclosure components
according to DIN 16901-140*

Achtung,
Maßstab beachten (1:2)

Maßstab/ Scale: 1:2 (1:5)
Zeichnungs-Nr. / Drawing-No.: OK 5460.014.01

Artikel / Article:
Polysafe
PS 642-T
Katalogz./Catalogue draw.

A Nr. / Art. No.:
Datum / Date:
DISK: 24042911dw
Datum / Date: 26.04.2019 AH



A Phoenix Mecano Company