

FIELDLED EVO 790_96 Aufbau, 790 mm, 24V DC

Artikel-Nr.: 153210-01
EAN: 4260556625492

Bestell-Nr.:	153210-01
Modell:	FIELDLED EVO 96 Aufbau
Bauform:	LED Aufbauleuchte für Maschinen
Leuchtmittel:	SMD LED
Lampenleistung:	~58 W
Lampenlichtstrom:	9000 lm
Lampenlichtausbeute:	155 lm/W
Lichtverteilung:	direkt
Lichtfarbe:	Tageslichtweiß (5200 - 5700K)
Anschlusswert Leuchte:	24V DC ± 10%
Anschluss Leuchte:	M12 Sensorstecker A-kodiert, stirnseitig
Schutzart:	IP67/IP69K
Schutzklasse:	III
Entblendung:	Mikroprismen
Abstrahlwinkel:	100°
Betriebstemperatur:	-30... +60 °C
Farbwiedergabe (Ra):	> 85
Lampenlebensdauer:	> 60.000 h
Material Gehäuse:	Aluminium
Material Abdeckung:	ESG (Sicherheitsglas), splitterfrei
Höhe [B] x Breite [C]:	30 x 96 mm
Länge [A]:	790 mm
Gewicht:	~2600 g
Bruttogewicht:	~3500 g
Risikogruppe:	freie Gruppe
Befestigungszubehör:	optional; 2 Schraubkanäle für M5 rückseitig
Dimmbar:	optional über Zubehör
Kennzeichnung:	CE, ETL Listed
Gefertigt in:	Deutschland

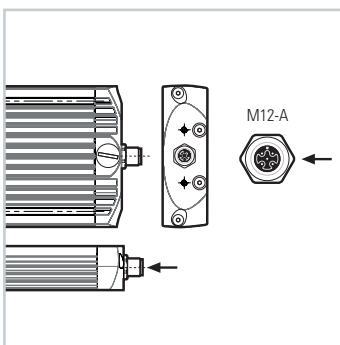
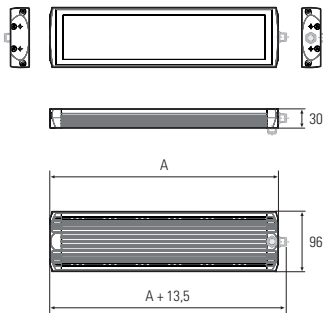
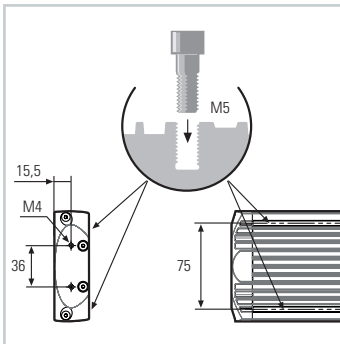

Lampenlebensdauer in Betriebsstunden (L80/B10)

FIELDLED EVO 790_96 Aufbau, 790 mm, 24V DC

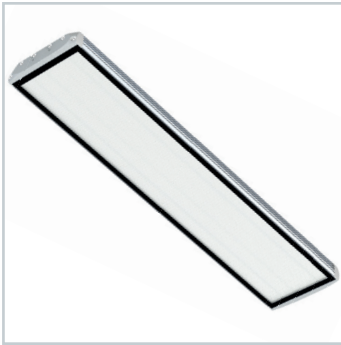

Item number: 153210-01
EAN: 4260556625492

Order number:	153210-01
Model:	FIELDLED EVO 96 Aufbau
Type:	LED surface-mounted luminaire for machines
Illuminant:	SMD LED
Power consumption:	~58 W
Lamp luminous flux:	9000 lm
Lamp luminous efficiency:	155 lm/W
Light distribution:	direct
Light colour:	daylight white (5200 - 5700K)
Connected load:	24V DC \pm 10%
Connection:	M12 sensor connector, A-type encoded, front-end
Degree of protection:	IP67/IP69K
Class of protection:	III
Glare-free	microprism
Beam angle (optics):	100°
Operating temperature:	-30... +60 °C
Colour rendering (Ra):	> 85
Lamps lifetime:	> 60,000 h
Housing material:	aluminium
Cover material:	ESG (toughened safety glass), shatterproof
Height [B] x Width [C]:	30 x 96 mm
Length [A]:	790 mm
Weight (net):	~2600 g
Gross weight:	~3500 g
Risk group (DIN EN 62471):	free group
Mounting accessories:	optional; two continuous screw channels for metric screws with thread M5 on the reverse
Dimmable:	via optional accessory
Marking:	CE, ETL Listed
Made in:	Germany

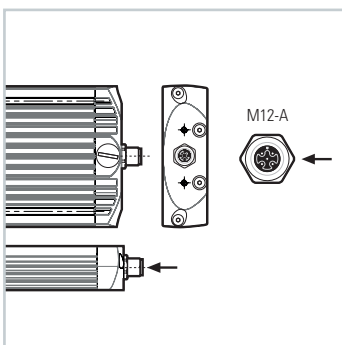
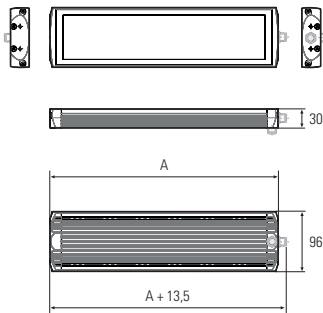
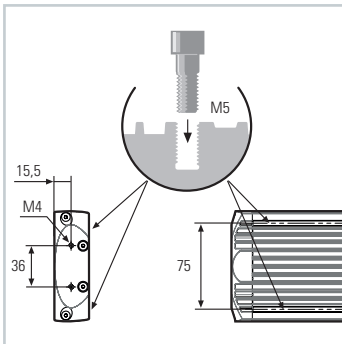

Lamps lifetime in operation hours (L80/B10)