

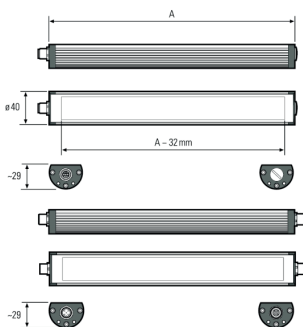

## TUBELED\_40 Element DC, 540 mm, 24V DC, kaskadierbar

<b>Artikel-Nr.:</b>	119310-12
<b>EAN:</b>	4260556624358

<b>Bestell-Nr.:</b>	119310-12
<b>Modell:</b>	TUBELED_40 Element
<b>Bauform:</b>	LED Aufbauleuchte
<b>Leuchtmittel:</b>	SMD LED
<b>Lampenleistung:</b>	~13 W
<b>Lampenlichtstrom:</b>	1890 lm
<b>Lampenlichtausbeute:</b>	145 lm/W
<b>Lichtverteilung:</b>	direkt
<b>Lichtfarbe:</b>	Tageslichtweiß (5200 - 5700K)
<b>Anschlusswert Leuchte:</b>	24V DC $\pm$ 10%
<b>Anschluss Leuchte:</b>	M12 A-kodiert
<b>Schutzart:</b>	IP54
<b>Schutzklasse:</b>	III
<b>Entblendung:</b>	Diffusor, PMMA
<b>Abstrahlwinkel:</b>	100°
<b>Betriebstemperatur:</b>	-30... +70 °C
<b>Farbwiedergabe (Ra):</b>	> 85
<b>Lampenlebensdauer:</b>	> 60.000 h
<b>Material Gehäuse:</b>	Aluminium, Endkappen Kunststoff
<b>Material Abdeckung:</b>	PMMA, gefrostet
<b>Höhe [B] x Breite [C]:</b>	29 mm x 40 mm
<b>Länge [A]:</b>	540 mm
<b>Gewicht:</b>	690 g
<b>Bruttogewicht:</b>	900 g
<b>Risikogruppe:</b>	freie Gruppe
<b>Kennzeichnung:</b>	CE
<b>Befestigungszubehör:</b>	optional
<b>Dimmbar:</b>	optional über Zubehör
<b>Gefertigt in:</b>	Deutschland
<b>Besonderheit:</b>	kaskadierbar, hochtemperaturbeständig



Elektrische Durchgangsverdrahtung (kaskadierbar) bis max. 8 A DC bei ta max. +30 °C (7 A DC bei ta max. +40 °C)  
Lampenlebensdauer in Betriebstunden (L80/B10)



## TUBELED\_40 Element DC, 540 mm, 24V DC, cascadable

**Item number:** 119310-12  
**EAN:** 4260556624358

<b>Order number:</b>	119310-12
<b>Model:</b>	TUBELED_40 Element
<b>Type:</b>	LED surface-mounted luminaire
<b>Illuminant:</b>	SMD LED
<b>Power consumption:</b>	~13 W
<b>Lamp luminous flux:</b>	1890 lm
<b>Lamp luminous efficiency:</b>	145 lm/W
<b>Light distribution:</b>	direct
<b>Light colour:</b>	daylight white (5200 - 5700K)
<b>Connected load:</b>	24V DC $\pm$ 10%
<b>Connection (connector):</b>	M12 A-type encoded
<b>Degree of protection:</b>	IP54
<b>Class of protection:</b>	III
<b>Glare-free</b>	diffuser sheet for scattered light, PMMA
<b>Beam angle (optics):</b>	100°
<b>Operating temperature:</b>	-30... +70 °C
<b>Colour rendering (Ra):</b>	> 85
<b>Lamps lifetime:</b>	> 60,000 h
<b>Housing material:</b>	aluminium, endcaps made of plastics
<b>Cover material:</b>	PMMA, frosted
<b>Height [B] x Width [C]:</b>	29 mm x 40 mm
<b>Length [A]:</b>	540 mm
<b>Weight (net):</b>	690 g
<b>Gross weight:</b>	900 g
<b>Risk group (DIN EN 62471):</b>	free group
<b>Marking:</b>	CE
<b>Mounting accessories:</b>	optional
<b>Dimmable:</b>	via optional accessory
<b>Made in:</b>	Germany
<b>Feature:</b>	cascadable, resistant to high temperatures

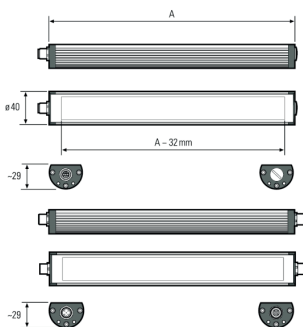

Several luminaires can be interlinked electrically. Electrical through-wiring (cascadable) up to max. 8 A DC at ta max. +30 °C (7 A DC at ta max. +40 °C)  
Lamps lifetime in operation hours (L80/B10)