

AQUAPIX®

WDV5630

WATERPROOF DV CAMCORDER

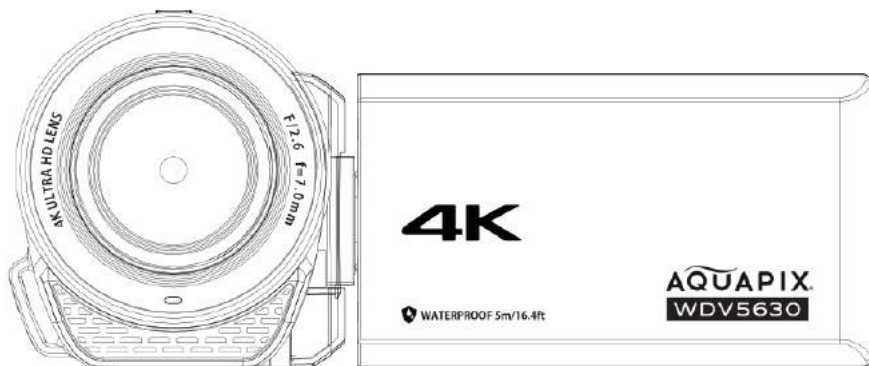

USER MANUAL

FR : Un manuel dans votre langue est disponible sur Internet:

IT: Il manuale nella sua lingua può essere trovato su Internet:

ES: Puede encontrar un manual en su idioma en Internet:

PT: Um manual em seu idioma pode ser encontrado na Internet:

PL: Instrukcję w swoim języku możesz znaleźć na stronie:

SV: En handbok på ditt språk finns på Internet:

NL: Een handleiding in uw taal vindt u op internet:

bit.ly/3JtIJul



Table of contents

General instructions	4
Explanation of symbols	4
Product introduction	5
Declaration and prove safety	5
Intended use	5
Restrictions.....	6
Safety instructions.....	7
Operating environment.....	8
Storage environment.....	10
Camera description	11
First use	13
Step 1: Insert the battery	13
Step 2: Charge the battery	14
Step 3: Insert a microSD card	15
Step 4: Turn on the camera	15
Step 5: Format the microSD card	15
Camera settings.....	16
Video mode	17
Video screen icons.....	18
Video settings.....	19
Photo mode.....	20
Photo screen icons	21
Photo settings	22

Playback mode	24
Playing files.....	24
Photo slideshow	24
Deleting files.....	25
Protecting files	26
Playback screen icons.....	27
Recording times.....	29
Connecting to PC	30
Connecting to TV	32
Technical specifications	33
Troubleshooting	35
Box contents.....	36
Disposal	37
Declaration of conformity	39

Disclaimer

Easypix makes no representations or warranties with respect to this manual and, to the extent permitted by law, expressly limits its liability for breach of any warranty that may arise from replacement of this manual by another. Furthermore, Easypix reserves the right to revise this publication at any time without obligation to notify any person of the revision.

Easypix is not responsible or liable for the misuse of the information contained herein. If you have suggestions for improvement or changes or if you have found errors in this publication, please let us know.

All relevant state, regional and local safety regulations must be observed when installing and using this product. For safety reasons and to ensure compliance with the documented system data, only the manufacturer may carry out repairs on components.

Failure to observe this information may result in personal injury or equipment damage.

Copyright © Easypix GmbH

All rights reserved. No part of this publication may be reproduced, distributed or transmitted in any form or by any means, including photocopying, recording or other electronic or mechanical means, without the prior written permission of the publisher. For permission requests, please contact the publisher in writing.

Easypix GmbH, Em Parkveedel 11, 50733 Cologne, Germany
support@easypix.com - www.easypix.com

General instructions

Please read this manual and its safety instructions before using this product. Follow all instructions. This will prevent hazards that could result in property damage and/or serious injury.

The product may only be used by persons who have fully read and understood the contents of this user manual. Make sure that each person using the product has read and follows these warnings and instructions.

Keep all safety information and instructions for future reference and pass them on to subsequent users of the product.

The manufacturer is not liable for damage to property or personal injury resulting from incorrect handling or failure to observe the safety instructions.

Explanation of symbols



WARNING

Warning indicates a hazard with a medium level of risk which, if not avoided, could result in serious injury.

NOTE!

"Note" indicates information that is considered important but is not hazard-related.

Product introduction

Aquapix WDV5630 is a waterproof digital camcorder. Dustproof and waterproof at depths of up to 5 metres it records video up to 4K resolution and captures images up to 56MP. A removable battery, memory card support up to 128GB, 18x digital zoom and a rotating 3.0" IPS screen ensure the best user experience.

Declaration and prove safety

The product has been verified in accordance with the essential requirements and other relevant provisions of Directives 2014/30/EU, 2011/65/EU & (EU) 2015/863 and in accordance with the Radio Equipment Regulations 2017 (SI 2017 No. 1206).

Its safety complies with the requirements of the relevant national regulations.

Intended use

This product can be used anywhere high quality video or still photography is required and is optimised for underwater use up to 5m.

Restrictions



WARNING

The product is not suitable for children under 3 years of age. Contains small parts. Risk of suffocation.

When connected to a TV ensure any connected cables do not present a trip hazard.



WARNING

- Before using the product in water, ensure the battery compartment cover is securely closed and locked.
- After use in salt or chlorinated water, clean the housing under tap water and allow it to dry.
- Do not use the camcorder while submerged deeper than 5 meters or for more than 1 hour.
- The waterproof integrity cannot be guaranteed if the camcorder is subject to impact such as a drop or fall.

Safety instructions



WARNING

This product is only suitable for the purpose described.

The manufacturer is not liable for damage caused by improper use.



WARNING

Please read these operating instructions carefully before use.

- Always protect your camera from falls, bumps and shocks.
- Keep a sufficient distance from objects that generate strong magnetic fields or radio waves to prevent them from damaging the product or affecting the sound and picture quality.
- In the unlikely event of overheating, smoke or unpleasant odours coming from the unit, disconnect it immediately from the charging cable and remove the battery to avoid fire.
- Please do not disassemble the product as doing so will void the warranty.

The product does not contain any user serviceable parts.

- Please dispose of the waste and residues at the end of the product's life in accordance with local laws and regulations.

Operating environment

- Please peel off the transparent protective film from the lens and screen before first use.
- It is normal for the case to become warm during use.
- To avoid condensation inside the housing or behind the lens, the product should not be exposed to large differences in temperature and humidity.
- Do not expose your camera to temperatures exceeding 40°.
- Protect the product from falls, bumps and knocks.
- Carrying or holding this product by the LCD screen increases the risk of dropping the unit and / or malfunction.
- While the monitor screen has more than 99.99% effective pixels, 0.01% of the pixels may be bright spots (red, blue, green) or dark spots. This is NOT a malfunction. The spots will not be reproduced in the recorded videos or captured images.

The waterproof camcorder body

Aquapix WDV5630 is waterproof and dustproof in accordance with the following standards:

Waterproof: Equivalent to IEC Standard publication 529 IPX8 and IPX6 (1 hour at depths up to 5 m)

Dustproof: Equivalent to IEC Standard publication 529 IP6X.

Fogging of the lens

Camcorders featuring waterproof specifications are airtight. When the temperature rises during use, condensation can occur inside the lens due to the internal humidity.

To minimise this effect please consider the following measures:

- Avoid frequent exposure to direct sunlight.
- Long hours of handheld use may cause the unit temperature to rise. Consider using a tripod where possible.
- Charge the unit in a low humidity environment.

When fogging occurs inside the lens, close the monitor, open the battery compartment and remove the battery. Leave the camera for a short period of time until the fogging reduces.

Precautions for waterproof use

Malfunction due to customer error or misuse is not covered by warranty. Before use in water close the battery cover firmly until it is securely locked and watertight.

Ensure sure that there is no damage to the seals and lock and that no foreign materials cause an obstruction to prevent the compartment being securely locked as required.

Do not use the camcorder in sea water and fresh water at a depth deeper than 5 meters or for more than 1 hour at a time.

The waterproof functionality cannot be guaranteed if the camcorder is subject to impact such as a fall or drop.

Do not use the camcorder in strong water flow such as in rapids or under waterfalls or any scenario where strong water pressure may compromise the waterproof performance.

Storage environment

Store the product in a cool place (at room temperature) in a dry and dust-free environment and never expose it to high temperatures or prolonged exposure to direct sunlight.

Camera description

【Front side view】

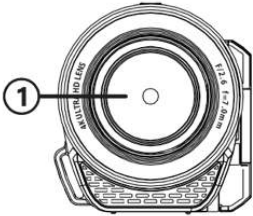

【Back side view】

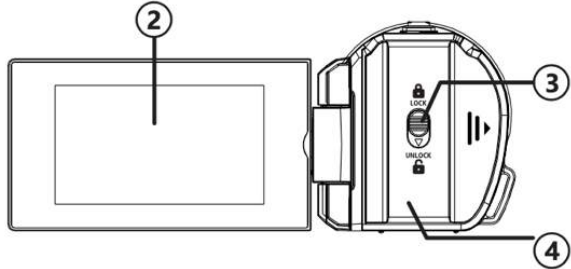

【Top side view】

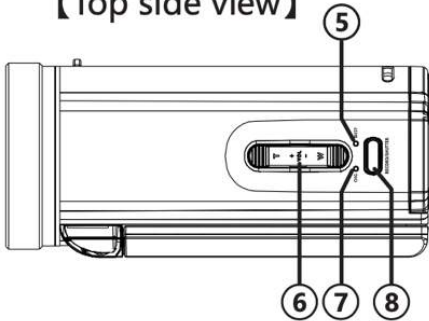

【Bottom side view】

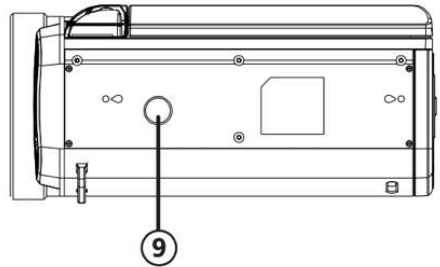

1. Lens
2. LCD display
3. Battery compartment lock
4. Battery compartment door
5. Power/Activity LED
6. Zoom/Volume button
7. Charging LED
8. Record/Shutter button
9. Tripod mount

- 10. Microphone
- 11. Speaker
- 12. Power on/off
- 13. Mode/OK button
- 14. Menu button
- 15. Down button
- 16. Up button
- 17. Hand strap

【Left side view】

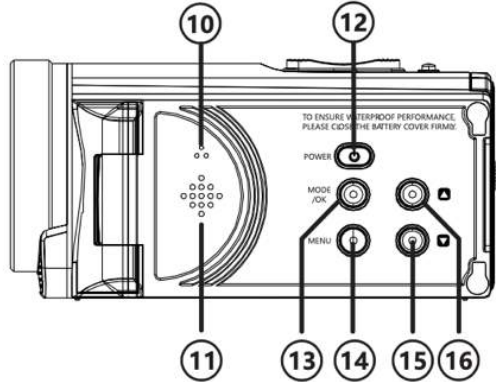

【Right side view】

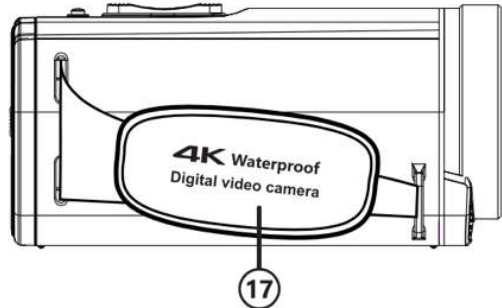

First use

NOTE!

To ensure optimum performance from your camera, please follow the steps below when using the camera for the first time.

Step 1: Insert the battery

Before using the product for the first time, make sure the battery is fully charged.

- To open the battery compartment, slide the lock downward and hold it in the unlock position.
- Push the compartment cover to the right to release and open.
- Insert the battery and close the battery compartment cover being careful to ensure that the door seals are correctly in place.
- Slide the cover until it clicks back into place.
NOTE: The cover is not securely sealed if the security lock is in the UNLOCK position.

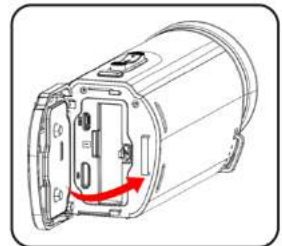
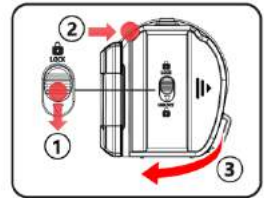

Step 2: Charge the battery

To achieve the fastest charge, ensure the camcorder is switched off during charging.

- It is possible to charge the camcorder during recording or playback however the charging time will be longer than if the camera was switched off.
- The device should only be charged via the USB port of a computer or USB power supply with a maximum output of 1050mAh.
- Open the battery compartment cover.
- Connect the USB cable supplied to the USB port
- Connect the other end of the USB cable into your computer or AC adaptor to start the charging cycle.
- The 'CHG' charging LED [7] will illuminate while the device is charging.
Charging is complete when the 'CHG' LED switches off.

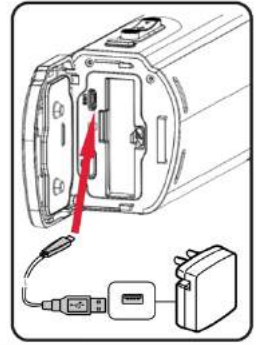

Step 3: Insert a microSD card

The camcorder supports the use of a Micro SD memory card up to a maximum capacity of 128GB.

Ensure the SD card used has a read/write speed of Class 10 or faster.

Step 4: Turn on the camera

Press and hold the Power button [12] for up to 3 seconds to turn on the camera.

To turn off the camera, press and hold the Power button again for up to 3 seconds.

Step 5: Format the microSD card

To ensure the optimum performance of the memory card, it should be formatted in the camcorder before using it for the first time.

NOTICE

The formatting process deletes any data or files currently on the card. Please ensure important files are backed up before formatting the card for use with the camcorder.

Enter the 'Format' settings in the user menu to complete the formatting process.

- Press 2x the Menu button [14] and navigate to the 'Format' menu option.
- Press the OK button [13] to confirm the 'Format' process.
- When formatting is complete, press the Menu button [14] to exit the settings menu.

Camera settings

Press the **Menu** button [14] twice to enter the camera settings menu.

Press the **Up** [16] and **Down** [15] buttons to navigate the menu.

Press the **Mode/OK** button [13] to confirm selections.

Date & Time	Use the Menu/OK and Up Down buttons to set the time and date
Date & Time stamp	Activate/Deactivate time and date stamp on photos and videos
Auto power off	Set time at which camera automatically powers off
Screen save	Set time at which LCD display screen saver activates
Beep sound	Activates/deactivates beep sound on button press

Language	Choose your preferred menu and display language
Power Frequency	Set the frequency according to your local power supply
Format	Format the SD card
Default settings	Reset the camera to factory settings
Version	Displays the currently installed firmware version

Video mode

Before recording confirm that a memory card is inserted and recognised by the camcorder.

If the camera is not already in 'Video' mode, press the Mode/OK button [13] until the video icon is displayed in the top right corner of the LCD display.

Pressing the Mode button will change the operating modes in the following sequence:

Video Recording > Photo > Playback

Press the Record/Shutter button [8] to start recording. The Red 'recording' icon and recording time will appear in the LCD display.

Video screen icons

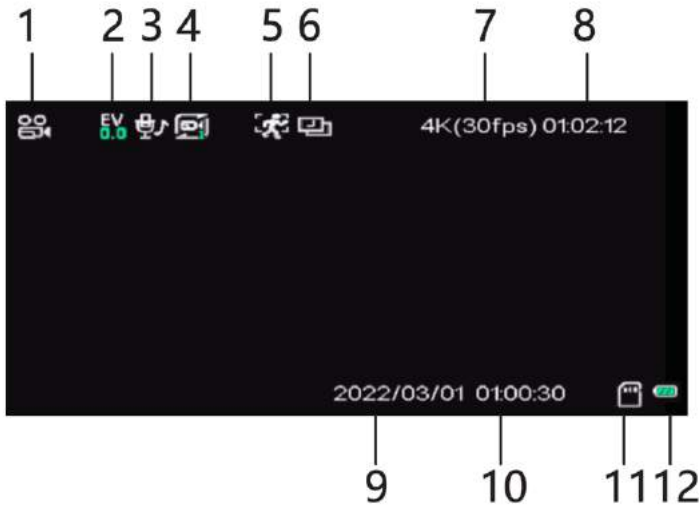

- | | | |
|-----------------|---------------------------|-------------------|
| 1. Video mode | 5. Motion detection | 9. Date |
| 2. EV | 6. Time lapse | 10. Time |
| 3. Audio status | 7. Resolution | 11. Memory card |
| 4. Loop record | 8. Elapsed Recording Time | 12. Battery level |

NOTE!

- Never remove the card while the Activity LED[5] is illuminated as this could result in lost or corrupt data.
- With the 'Auto Power Off' function activated, the camera will turn off automatically if left idle for 3 minutes. This setting can be changed in the camera settings menu.

- A recording that exceeds 4GB in size is automatically divided and recorded as multiple files.

Video settings

While in Video mode, press the **Menu** button [14] once to enter the Video settings menu.

Press the **Up** [16] and **Down** [15] buttons to navigate the menu.

Press the **Mode/OK** button [13] to confirm selections.

Movie size	Selects the video recording resolution and frame rate
Loop recording	When a 'Loop Recording' option is turned ON the camera will record a video for the duration of time chosen. And when the time has elapsed the camera will start recording a new file for the same period of time. As soon as the card is full, the oldest video will automatically be overwritten.
Colour filter	Selects video recording effect
White balance	Adjusts the colour temperature according to recording conditions

Exposure	Exposure setting adjusts the shutter speed and determines how long the shutter on the camera lens stays open each time the shutter button is pressed to take a photo.
Motion detection	When set to ON the camera starts recording automatically after sensing motion within view of the lens
Record audio	Activate / Mute recording of audio on videos
Time-lapse	Time Lapse Video allows a video recording taken over a long duration to be compressed into a video with just a few minutes playing time, thus creating a time lapsed effect.

Photo mode

Press the **Mode/OK** button [13] to select Photo mode.

Use the LCD display to frame your shot.

Use the Zoom button [6] to zoom in or out if required.

T – Zoom in to capture a larger subject

W – Zoom out to capture a wider image

Press the Shutter button [8] to capture your photo.

Photo screen icons

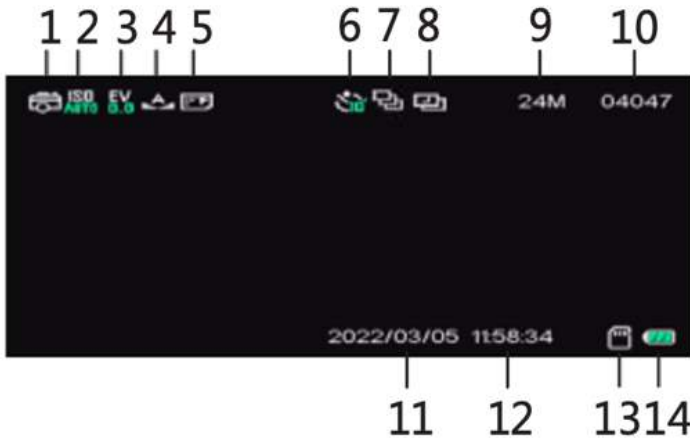

1. Photo mode

2. ISO

3. EV

4. White balance

5. Quality

6. Self timer

7. Burst

8. Time-lapse

9. Resolution

10. Shots
remaining

11. Date

12. Time

13. Memory card

14. Battery

Photo settings

While in Photo mode, press the **Menu** button [14] once to enter the Photo settings menu.

Press the **Up** [16] and **Down** [15] buttons to navigate the menu.

Press the **Mode/OK** button [13] to confirm selections.

Photo Size	Selects the photo resolution
Time-lapse capture	With the Time Lapse Photo function activated the camera automatically takes a series of timed photos in repetition until the shutter button is pressed to stop the sequence. The time taken between each photo can be set in the menu option.
Self-timer	With the Photo-Timer turned ON the camera automatically takes a single photo after a set time delay.
Color filter	Selects Photo effect
Photo burst	The Photo Burst function allows you to take multiple photos in rapid succession with just a single press of the shutter button. The number of photos taken can be selected in settings.
Quality	Select preferred photo quality
Sharpness	Select preferred Sharpness settings

White balance	Adjusts the color temperature according to recording conditions
ISO	ISO settings will brighten or darken a photo. As you increase your ISO number, your photos will grow progressively brighter.
Exposure	Exposure setting adjusts the shutter speed and determines how long the shutter on the camera lens stays open each time the shutter button is pressed to take a photo.
Metering	<p>Metering evaluates the light of a scene to determine the correct shutter speed, aperture, or ISO</p> <p>Average Metering - uses light information from the entire scene and creates an average for the final exposure setting, giving no weighting to any particular portion of the metered area.</p> <p>Center-weighted Metering - evaluates the light in the middle of the frame and its surroundings and ignores the corners</p> <p>Spot Metering - evaluates the light around your focus point and ignores everything else</p>

Playback mode

Using the LCD display, you can playback your videos, view your photos and delete any unwanted files.

Playing files

- Press the Mode/OK button [13] to enter Playback mode.
- Use the Up button[16] and Down[15] buttons to browse your files.
- Press the Record/Shutter button [8] to start video playback or view a photo.
- Use the Zoom button [6] to adjust the volume during playback.
- During video playback use the Down button [15] to fast forward playback (2X / 4X / 8X).
- Use the Up button [16] to rewind playback (-2X / -4X / -8X).

Photo slideshow

While in playback mode you can use the 'Slideshow' option to present your photos in a slide show mode with a user set time duration for the display of each photo.

- While in Playback mode, select any photo.
- Press the menu button [14] to open the photo

options menu.

- Use the Down button [15] to highlight 'Slide Show'.
- Press the Mode/OK button [13] to open the slide display time options.
- Use the Up [16] and Down [15] buttons to highlight the time required and press the Mode/OK button [13] to confirm.

The camera will then start the slideshow automatically. If the slide show does not start automatically press the Mode/OK button[13].

- Press the Mode/OK button [13] to pause/restart the slideshow.
- Press the Record/Shutter button [8] to stop the slide show.

Deleting files

- Select the file to be deleted.
- Press the Menu button [14] to open the sub-menu.
- Select [Delete] > [Delete this file] > [Yes/No]

Protecting files

To prevent accidental deletion of your favourite recordings or photos use the 'Protect' settings option in Playback mode.

- Enter Playback Mode and choose the video or photo file you wish to protect.
- Press the Menu button [14] and press the Down button [15] to highlight the 'Protect' option.
- Press the Mode/OK button [13] to enter the protect sub-menu.
- Choose whether you wish to lock / unlock the currently selected single file or all files at once.
- Press the Mode/OK button [13] to confirm your selection.
- Press the Menu button [14] twice to return to the Playback screen.
- All currently protected files will be confirmed with the display of the key icon  on the LCD display.

Playback screen icons

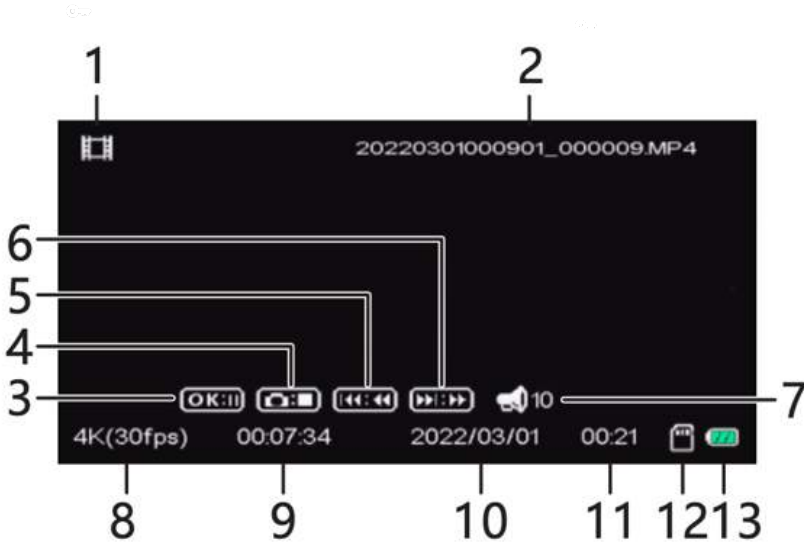

- | | |
|--------------------|-------------------------|
| 1. Video file | 8. Video resolution |
| 2. Video file name | 9. Current time display |
| 3. Pause | 10. Date of recording |
| 4. Stop | 11. Time of recording |
| 5. Fast rewind | 12. Memory card |
| 6. Fast forward | 13. Battery level |
| 7. Video volume | |

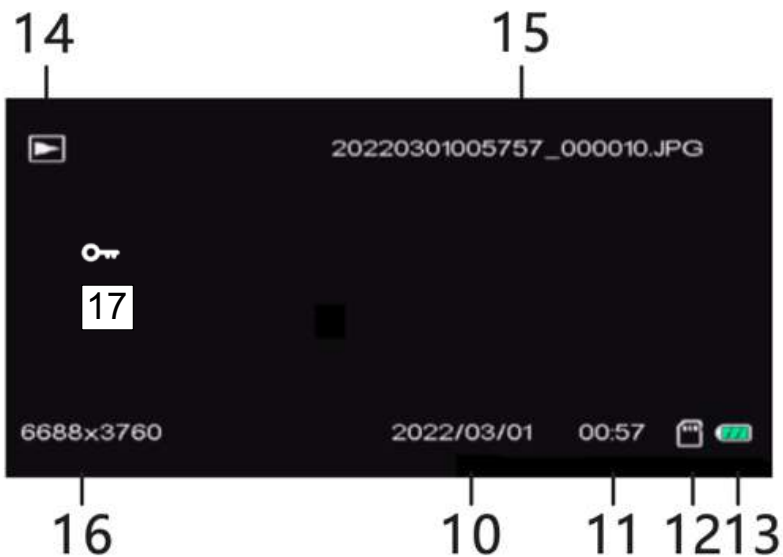

10. Date of recording

11. Time of recording

12. Memory card

13. Battery level

14. Photo file

15. Photo file name

16. Photo resolution

17. Protected File

Recording times

The table below outlines approximate maximum recording times when using various video resolution settings.

Recording times may vary depending on shooting conditions and memory card size.

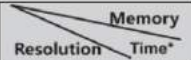
 Memory Resolution Time*	16G	32G	64G	128G
4K30fps	1h.01min	2h.03min	4h.07min	8h.25min
2.7K30fps	2h.25min	4h.30min	9h.10min	18h.30min
1080P60fps	1h.58min	4h.03min	8h.15min	16h.40min
1080P30fps	3h.09min	6h.28min	13h.16min	26h.41min

NOTE!

When a video recording file size reaches 4GB of data, while recording the camcorder automatically divides the recording and starts a new file. Recording is not interrupted. However the final recording will be comprised of 2 or more files depending on the length of time of the recording and the total amount of data saved.

This is a fundamental limit of all FAT file systems due to the maximum allowed file size on a FAT system.

Connecting to PC

By connecting your camcorder to a computer you can transfer files or use the camcorder as a webcam.

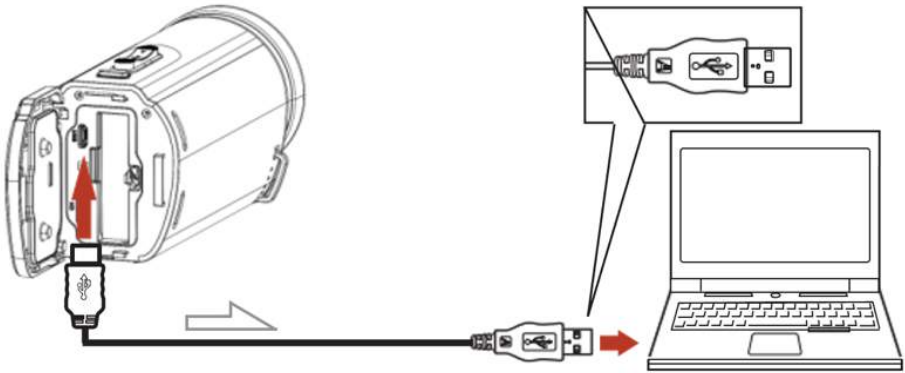

- Connect the camera to the USB port your computer using the USB cable supplied.
- Open the LCD display.
- The camcorder will automatically power on and display options for **Mass Storage** (File Transfer) or **PC Camera** (Windows® only).
- Press the Up button [16] and Down button [15] to make your selection and press the Mode/OK button [13] to confirm.

File transfer

- To transfer file from the camcorder to your computer select 'Mass Storage'.
- The camera will mount as an external device on your computer where you can copy the files required.

Webcam (Windows® only)

- To use the camcorder as a webcam select 'PC Camera'.
- If your computer does not display an image from the camcorder you may need to use the camera settings on your computer to select 'USB Camera' as the camera device being used.

NOTE!

To avoid connection to the computers built-in camera please disable the computers camera.

To prevent data loss or corruption, always eject or unmount the camera from your computer properly before disconnecting the USB cable.

Connecting to TV

NOTE!

Depending on the recording format and HDMI output settings, file playback may be limited.

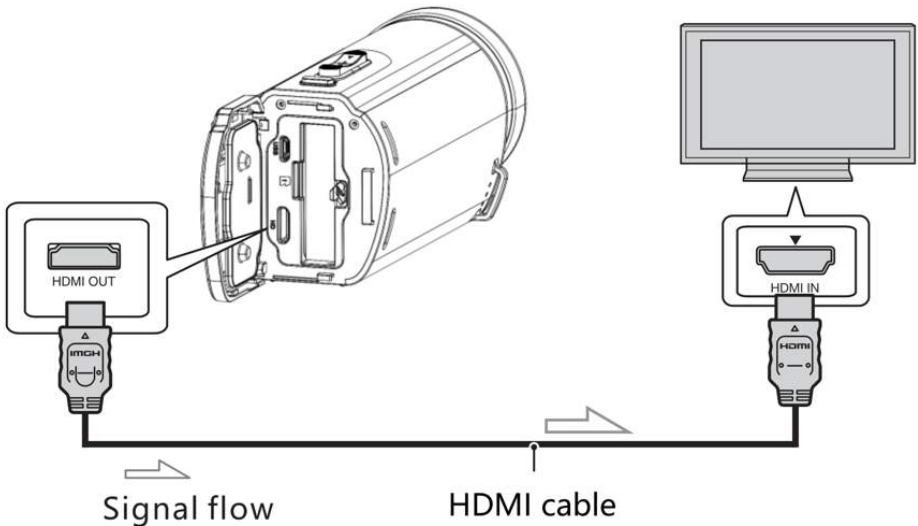

- Using the HDMI cable, connect the HDMI Output on the camcorder to the HDMI Input on the TV.
- Select the relevant HDMI Input on the TV.
- Enter Playback mode on the camera and start playback of the selected file.

Technical specifications

Video resolution	4K (30fps) 2.7K (30fps) 1080p (60/30fps) 720p (60/30fps)
Photo resolution	56M*/48M*/30M*/24M*/20M*/16M*/ 12M/8MP/5MP
Display	3.0"/7.6 cm
Sensor	13MP CMOS Sensor
ISO	Auto, 100, 200, 400, 800, 1600
Lens	Fixed, F/2.6, f=7.0 mm
Focus range	1 m ~ infinity
Waterproof	Waterproof up to 5m
Microphone/ Speaker	Built-in mic and speaker
Memory card	Supports Micro SD/SDHC up to 128GB, Class 10 or higher (not included)
Zoom	18x digital zoom
Screen saver	Off/5/10 min.
Auto power off	Off/1/2/3/5/10 min.
Motion detection	Off/On

Time-lapse video	Off/100mS/200mS/500mS/1sec/5sec/ 10sec/30sec/1min/5min
Time-lapse photo	Off/On
Colour filter	Colour, Black & White, Sepia
Photo burst	Off/3 Photos per shot
Loop recording	Off/1/3/5/10 min.
Self-timer	Off/2/5/10 sec.
White balance	Auto, Daylight, Cloudy, Tungsten Light, Fluorescent
Exposure	-3.0EV ~ +3.0EV
Metering	Average, Center-weighted, Spot
Photo quality	Fine, Normal, Economy
Photo sharpness	Soft, Normal, Strong
Record audio	Off/On
Frequency	50Hz, 60Hz
File formats	MP4, JPG
Interface	HDMI, Micro USB
Battery	P16 Li-Polymer, 3.400mAh, 3.8V, 12.92Wh
Product dimensions	135(L) x 65(W) x 67(H) mm
Product weight	Approx 400g (including battery)

*by interpolation

Troubleshooting

Problem	Possible cause	Solution
Camera will not power on	Battery not installed. Battery not charged.	Install battery as instructed. Charge battery.
Camera shuts off	Battery charge depleted. Auto-power off function enabled.	Charge battery. Adjust auto-power off settings.
Files not saved	Power interruption while saving.	Charge battery when CHG LED [7] turns red.
Problem focusing	Subject out of focus range.	Reduce distance to subject.
Memory card malfunction	Protected memory card. Document Format Error. Memory Card Damage.	Disable SD card protection. Format SD card in camera. Replace memory card.

Box contents

- Waterproof camcorder
- Battery
- Storage bag
- USB cable
- HDMI cable
- Manual (English, German)

Operating instructions in other languages are available for download at **<https://bit.ly/3JtIJul>** or

www.easypix.info/download-manuals/download/aquapix-wdv5630/

Disposal



Disposal of packaging:

Dispose of the packaging according to its type.

Add cardboard and paperboard to the waste paper, foils and plastic wrapping to the recyclable waste collection.



**LE TRI
+ FACILE**

BOITE



Séparez les éléments avant de trier

IMBALLAGGIO ESTERNO PAP 20 Cartone carta	IMBALLAGGIO DELLA BATTERIA PAP 22 Cartone carta
RACCOLTA DIFFERENZIATA	Verifica le disposizioni del tuo Comune. Svuotare l'imballaggio. Conferisci in raccolta il contenitore vuoto.



Waste electrical and electronic equipment and/or batteries disposed of by users in private households in the European Union:

This symbol on the product or on its packaging indicates that it cannot be disposed of with household waste. You must dispose of your old appliance and/or battery by handing it over to the applicable collection

system for the recycling of electrical and electronic equipment and/or batteries. For more information on recycling this device and/or battery, contact your local council, the shop where you purchased the device or your household waste disposal service. Recycling materials helps to conserve natural resources and ensures that it is recycled in a way that protects human health and the environment.



WARNING

Warning regarding batteries:

- Do not disassemble or hit the battery. Be careful not to short-circuit the battery. Do not expose the battery to high temperatures. Do not continue using the battery if it leaks or expands.
- Keep the battery away from children.
- Batteries can explode if exposed to an open fire.
Never throw batteries into fire.
- Dispose of used batteries according to local regulations.
- Before disposing of the device, remove the battery and dispose of it separately.

Declaration of conformity



EU Declaration of conformity

We hereby declare that the product is in conformity with the essential requirements and other relevant provisions of Directives 2014/30/EU and 2011/65/EU & (EU) 2015/863.

The full text of the EU Declaration of Conformity can be found in German and English at:

www.easypix.info/download/pdf/doc-wdv5630.pdf



UKCA Declaration of conformity

We hereby declare that the product complies with the Radio Equipment Regulations 2017 (SI 2017 No.1206).

The full text of the UK Declaration of Conformity can be found in English at:

www.easypix.info/download/pdf/doc-wdv5630.pdf

EASYPIX | LIFESTYLE
ELECTRONICS