

**38335 POLYPLATE**



**H0 Kubushaus Julia im Bau - Polyplate Bausatz**

**H0 Cube house Julia under construction - Polyplate kit**

|                           |                                   |
|---------------------------|-----------------------------------|
| <b>(DE)</b>               | <b>(EN)</b>                       |
| 1. Inhalt .....1          | 1. Contents .....1                |
| 2. Fenstermontage.....4   | 2. Mounting of the windows .....4 |
| 3. Aufbauvarianten .....5 | 3. Mounting variations.....5      |
| 4. Montage.....6          | 4. Mounting.....6                 |

Bitte legen Sie die Einzelteile nach Baugruppen zusammen und beginnen Sie dann entsprechend der Zeichnungen mit dem Zusammenbau.

Arrange the individual parts by assembly groups, and then begin assembling in accordance with the drawings.

Dieser Bausatz besteht aus nachhaltigem Polyplate Verbundwerkstoff.

This kit consists of sustainable Polyplate composite material.

Für den Zusammenbau dieses hochwertigen Polyplate-Bausatzes empfehlen wir unseren kibri Polyplate Kleber, Art. 39997.

For the assembly of this high-quality Polyplate glue, item 39997.

Änderungen vorbehalten. Keine Haftung für Druckfehler und Irrtümer. Die aktuelle Version der Anleitung finden Sie auf der Homepage unter der Artikelnummer.

Subject to change without prior notice. No liability for mistakes and printing errors. You will find the latest version of the manual on the website using the item number.

**1. Inhalt / Contents**

| Baugruppe<br>Assembly group                 | Teile-Nr.<br>Part No. | Stück<br>Pieces |
|---|-----------------------|-----------------|
| A   | 1                     | 1               |
|   | 2                     | 1               |
|   | 3                     | 1               |
|   | 4                     | 1               |
|   | 5                     | 1               |
|   | 6                     | 1               |
|   | 7                     | 1               |
|   | 8                     | 1               |
|   | 9                     | 1               |
|   | 10 + 11               | 1               |
|   | 12                    | 1               |
|   | 12B                   | 1               |
|   | 12C                   | 1               |
|   | 13                    | 1               |
|   | 14                    | 1               |
|   | 15                    | 1               |
|   | 10G                   | 1               |
|   | 20G                   | 1               |
|   | 40G                   | 1               |
| B   | 1+3                   | 1               |
|   | 2+4                   | 1               |
|   | 5+6                   | 1               |
|   | 7+8                   | 1               |
|   | 9                     | 1               |
|   | 10                    | 1               |
|   | 1+3OG                 | 1               |
|   | 2+4OG                 | 1               |
| C   | 1+3                   | 1               |
|   | 2+4                   | 1               |
|   | 5                     | 1               |
| FR  | 1                     | 1               |
|   | 2                     | 1               |
|   | 3                     | 1               |
| FV  | 1                     | 1               |
|   | 2                     | 1               |
|   | 3                     | 1               |
| <b>Montagehilfe</b><br>Assembly aid         |                       | 1               |
| <b>Tormontagestift</b><br>Door assembly pin |                       | 2               |

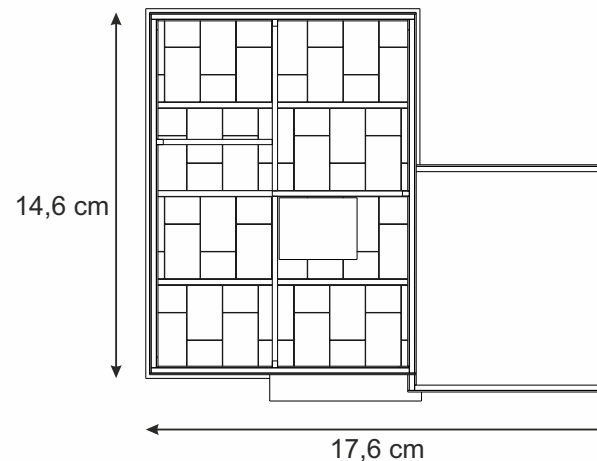

# Baugruppe A / Assembly group A

A1 OG

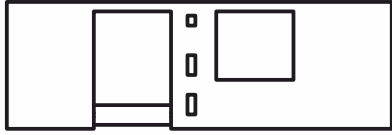

A2 OG

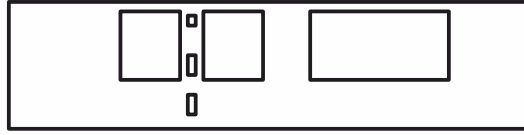

A3

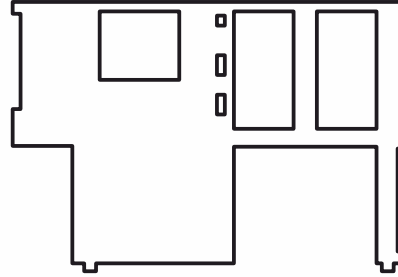

A4 OG

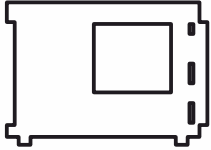
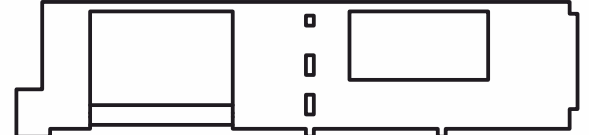

A1

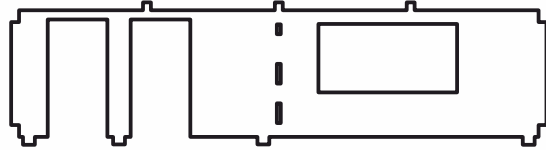

A2

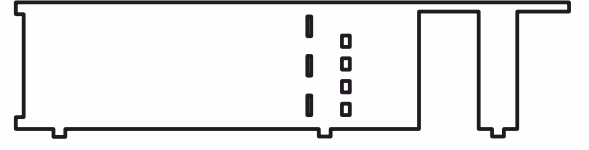

A4

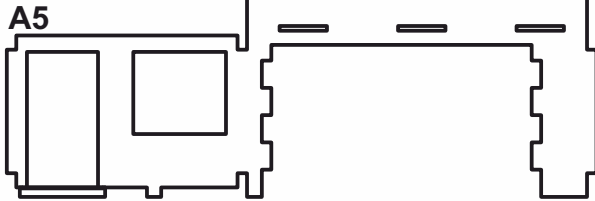

A5



A6

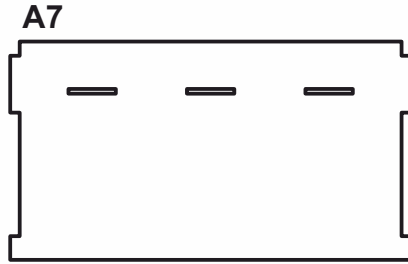

A7

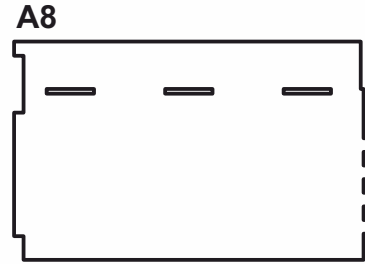

A8

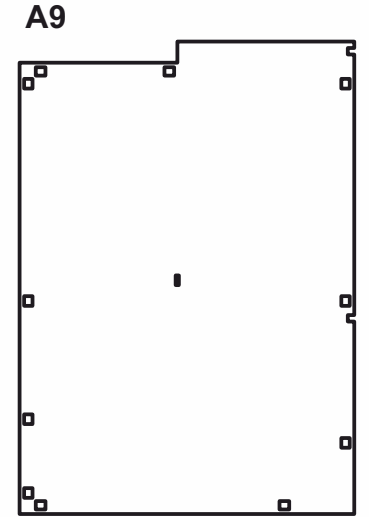

A9

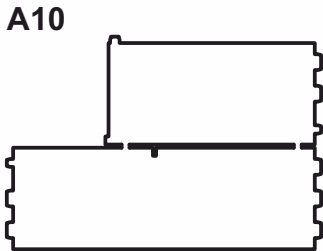

A10

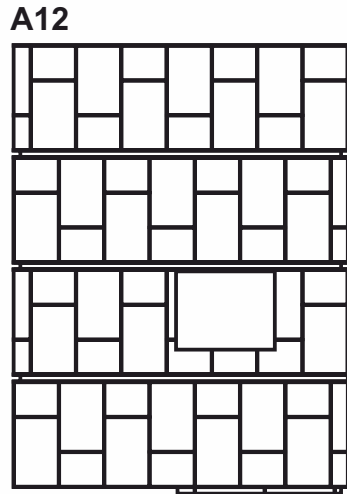

A12



A12 B

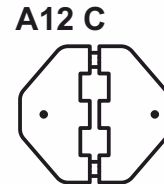

A12 C



A11

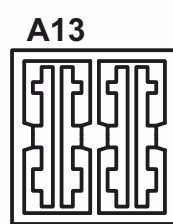

A13

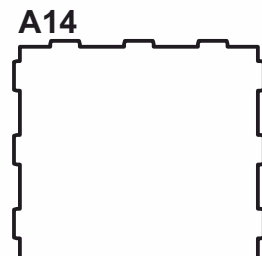

A14

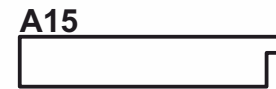

A15

# Baugruppe B / Assembly group B

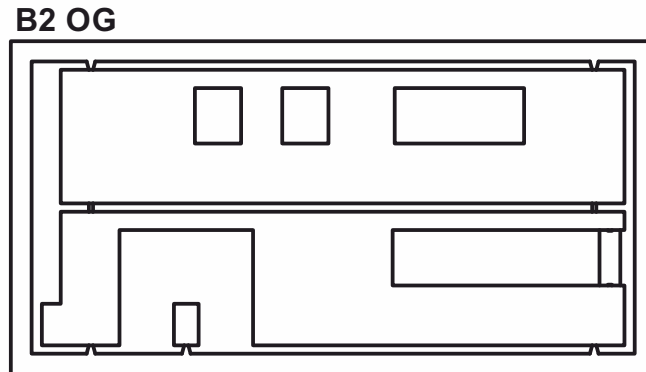
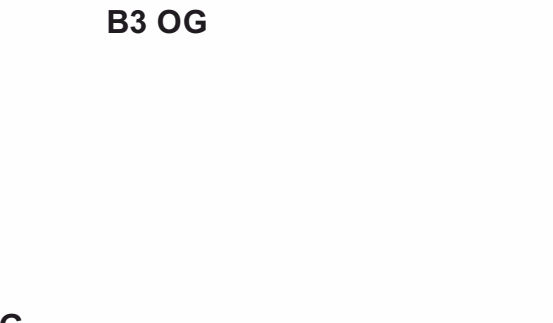
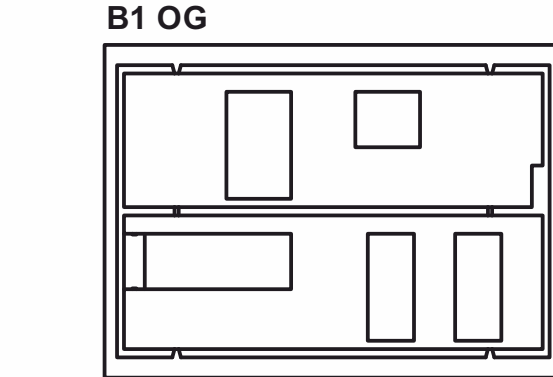
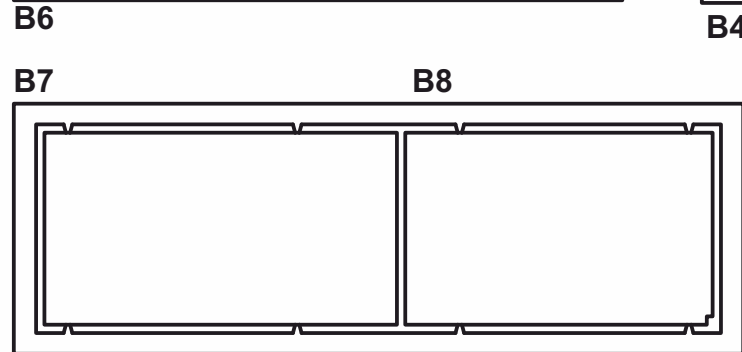
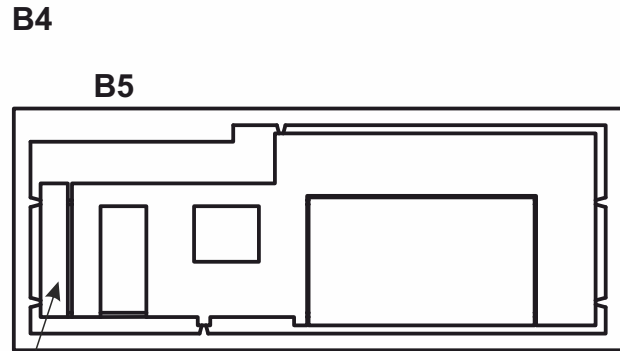
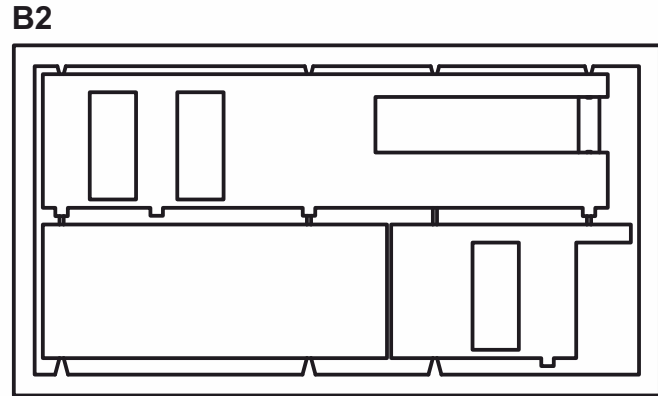
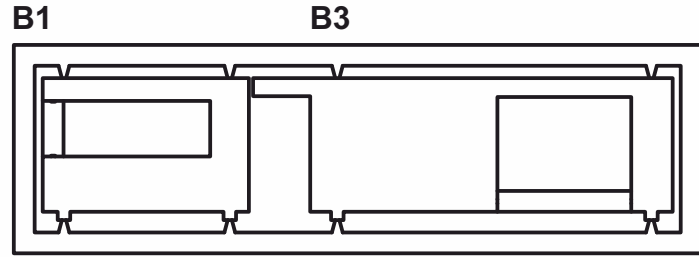

# Baugruppe C / Assembly group C

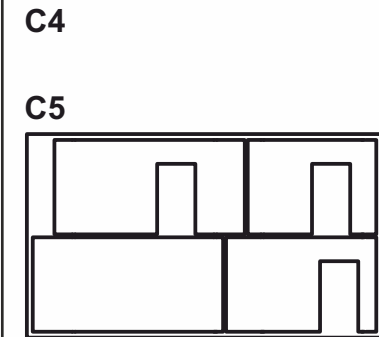
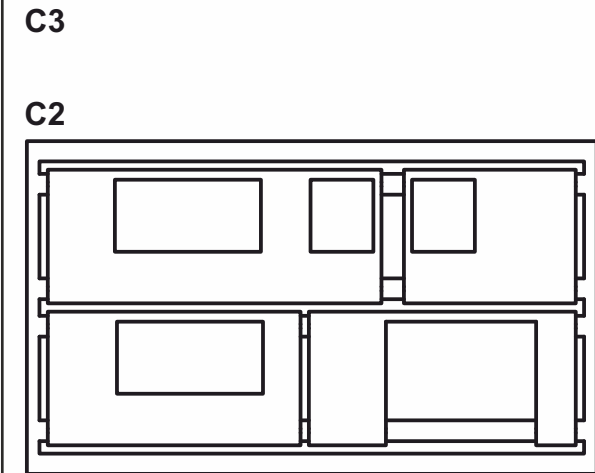
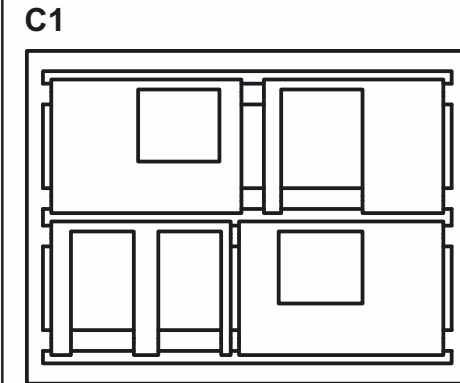

## Fenster und Türen / Windows and doors

FR 1

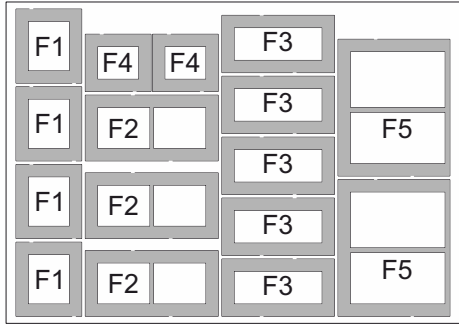

FR 3

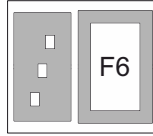

FR 2

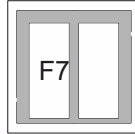

## Plexiglas Fensterscheibe / Plexiglass window

FV 1

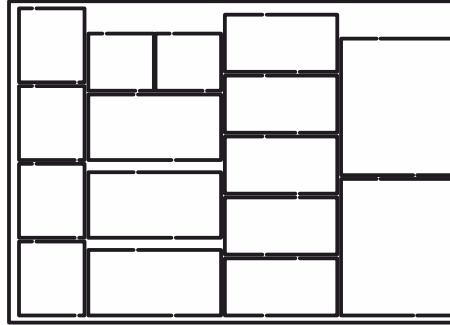

FV 3

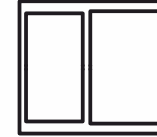

FV 2

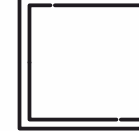

Montagehilfe  
Assembly aid

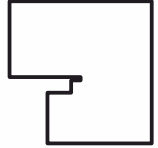

Tormontagestift  
Door assembly pin

2x

## 2. Fenstermontage / Mounting of the windows

Schutzfolie abziehen.  
Remove protection foil.

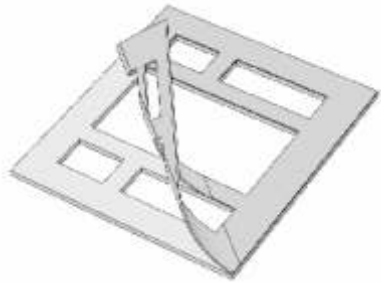

Mit der Klebeseite auf  
das Glas aufdrücken.  
Press adhesive side  
onto the glass.

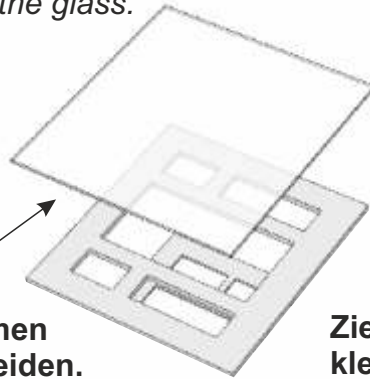

Am Rahmen  
ausschneiden.  
Cut alongside the frame.

Ziehen Sie nun die Schutzfolie ab und  
kleben die Fensterscheibe auf.  
Schneiden Sie diese bündig zu.  
Now remove the protection foil and stick on  
the window glass. Cut alongside the frame.

Knicken Sie das Eckfenster  
F7 vorsichtig in der Mitte.  
Eine Tischkante oder ein  
Lineal ist dabei hilfreich.  
Cautiously bend the corner window  
F7 in the middle. A ruler or a table's  
edge can be helpful for this.

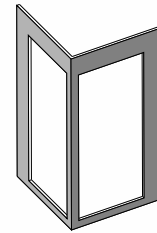

Die fertigen Fenster werden von innen montiert.  
The finished windows are mounted from inside.

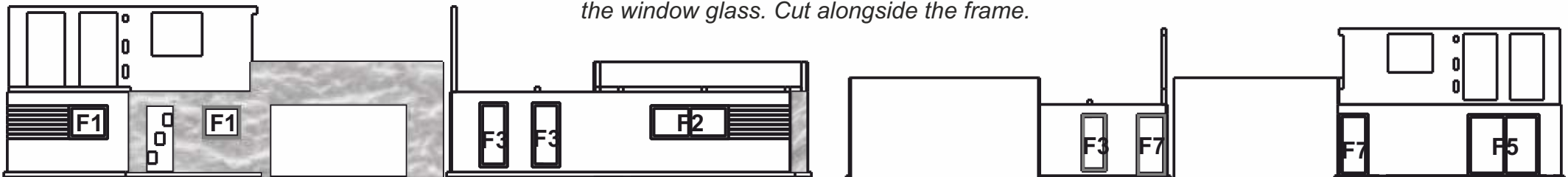
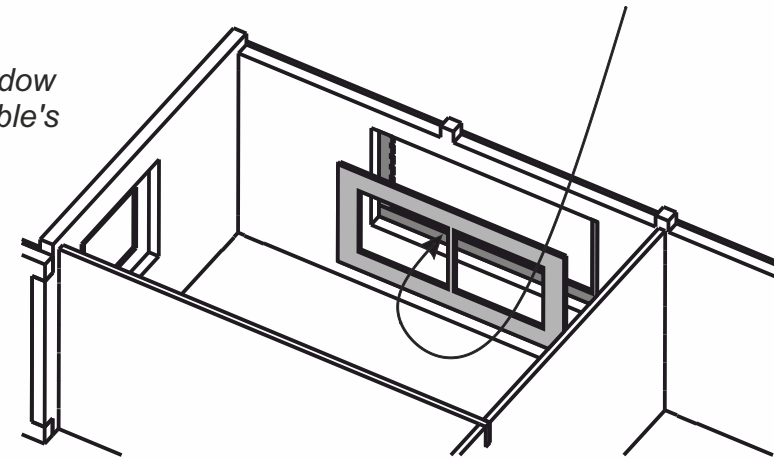

### 3. Aufbauvarianten / *Mounting variations*

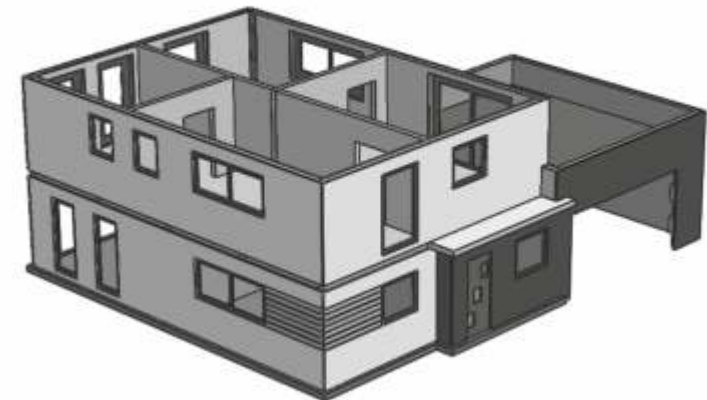
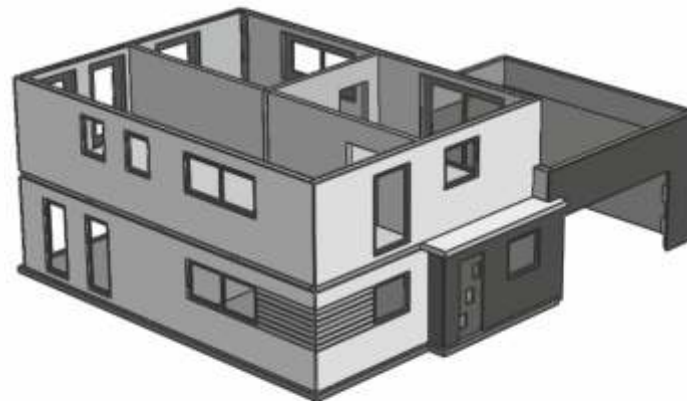
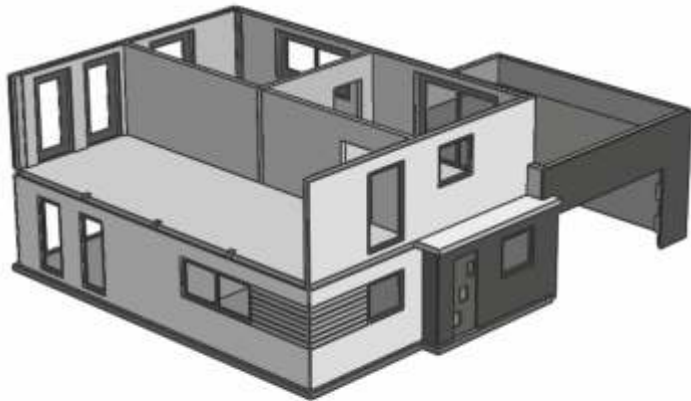
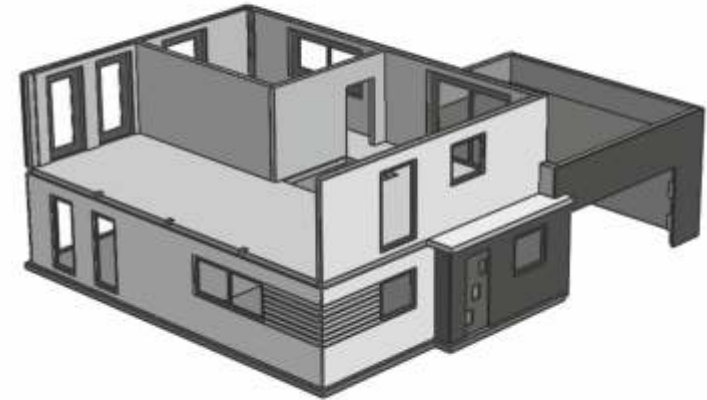
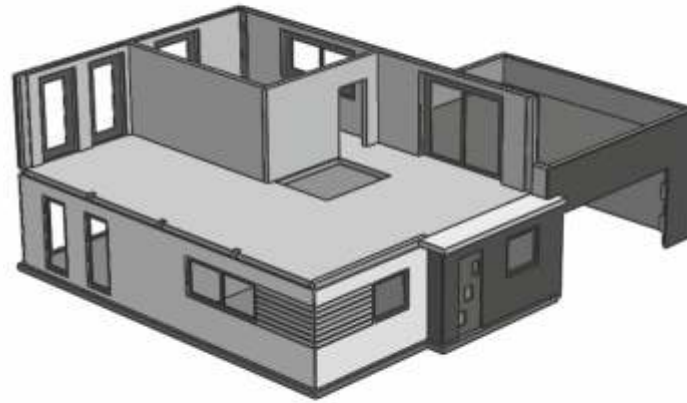
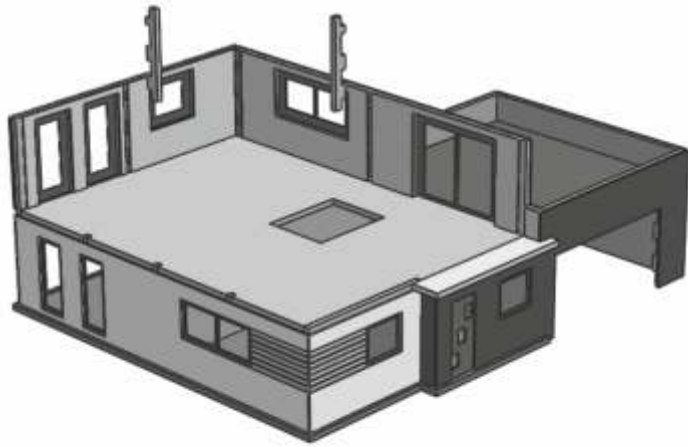

## 4. Montage / Mounting

①

**Die Bodenzapfen dienen nur zur Orientierung und sollten vor der Montage entfernt werden!**  
*The floor pegs are only for orientation and should be removed prior to mounting.*

**Montieren Sie zuerst A1 und A3, danach A2.**  
*Mount A1 and A3 prior to A2!*

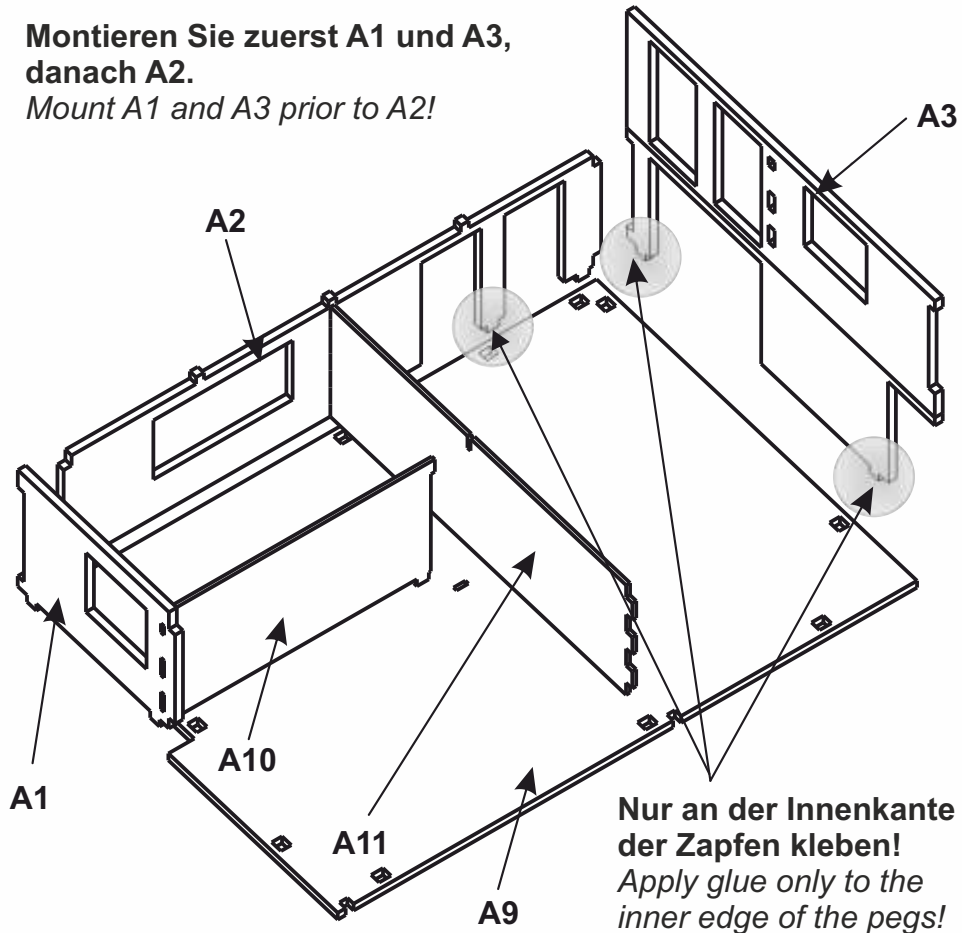

②

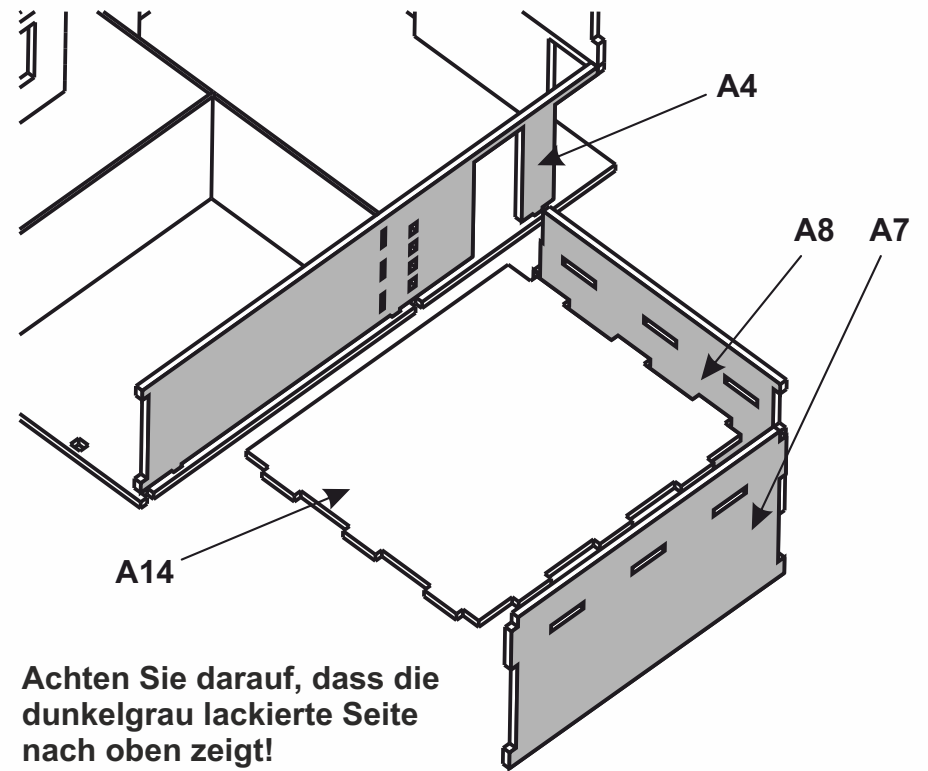

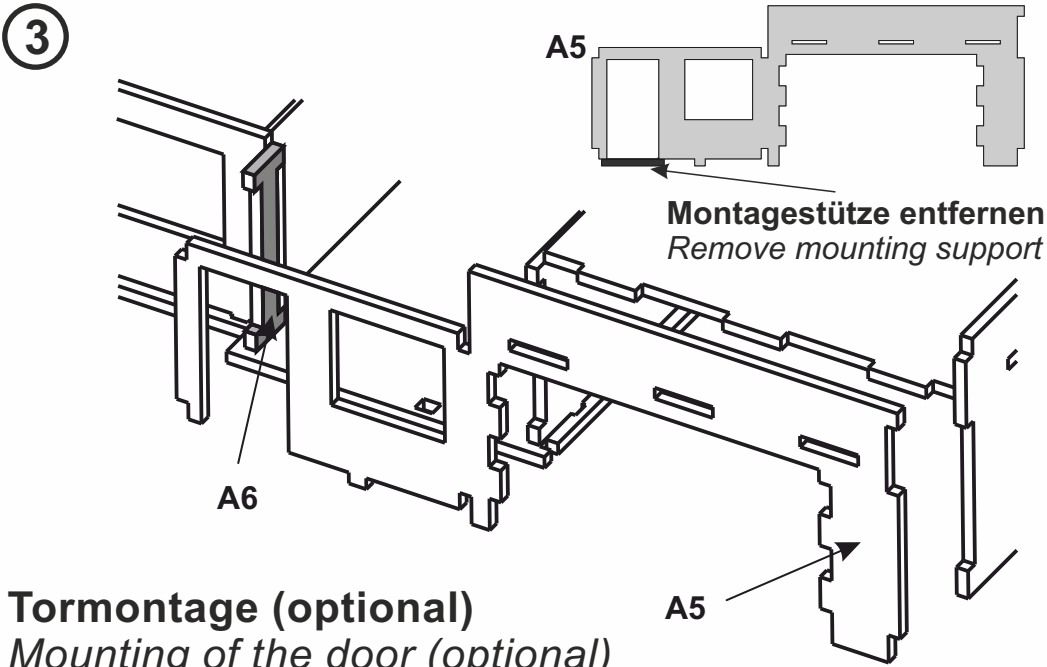

### Tormontage (optional) *Mounting of the door (optional)*

Führen Sie vor der Tormontage den Bauschritt 4 aus. Sonst lässt sich das Bauteil B4 nur noch sehr schwer festkleben!  
*Prior to mounting the door, carry out assembly step 4. Otherwise, it will be very difficult to glue on part B4!*

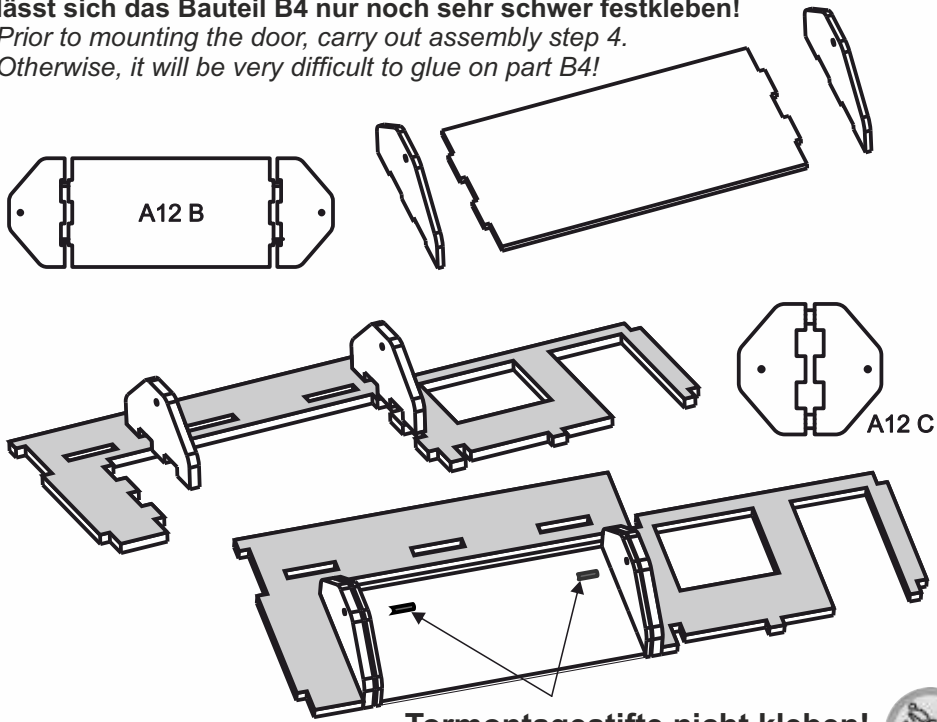

**Tormontagestifte nicht kleben!**  
*Do not glue door assembly pins!*

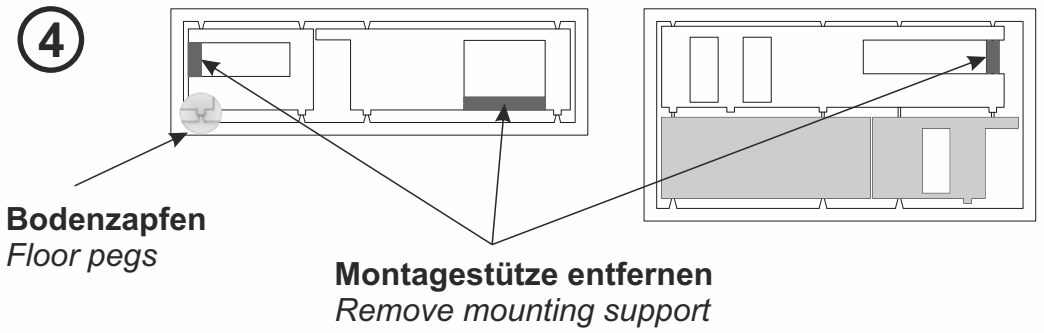

**Montagestützen nicht mit Klebstoff bestreichen. Nach der Verklebung der Fassade sind die Montagestützen zu entfernen.**  
*Do not coat the mounting supports with adhesive. After gluing the facade, remove the mounting supports.*

**Die Bodenzapfen dienen nur zur Orientierung und sollten vor der Montage entfernt werden!**  
*The floor pegs are only for orientation and should be removed prior to mounting.*

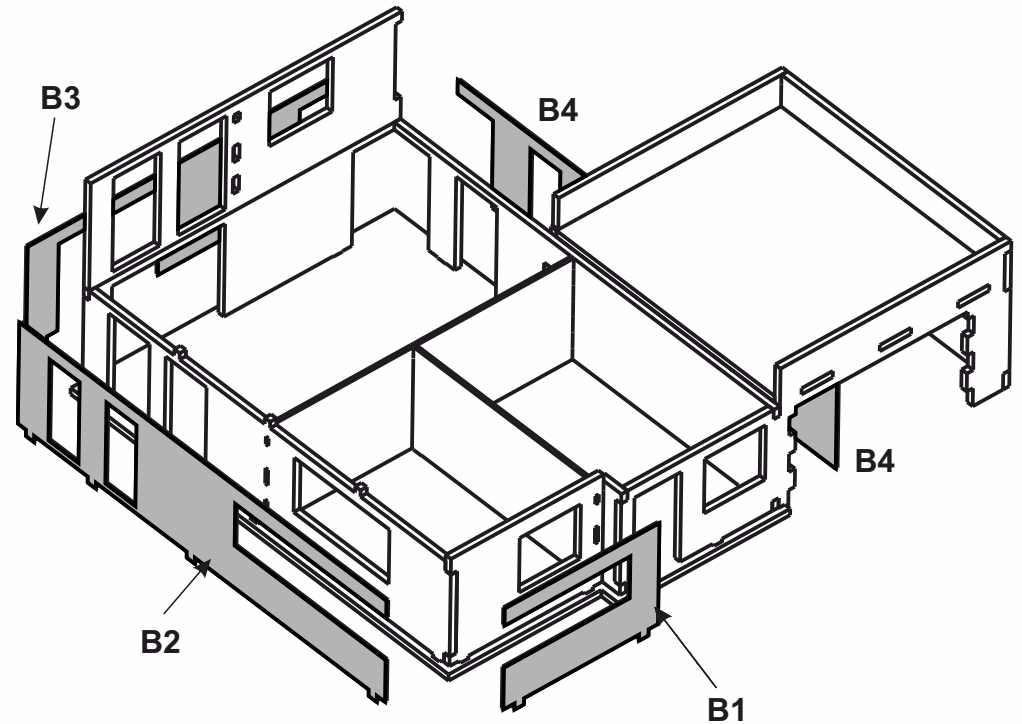

**Beginnen Sie die Montage mit Teil B1.**  
*Start mounting with part B1.*

5

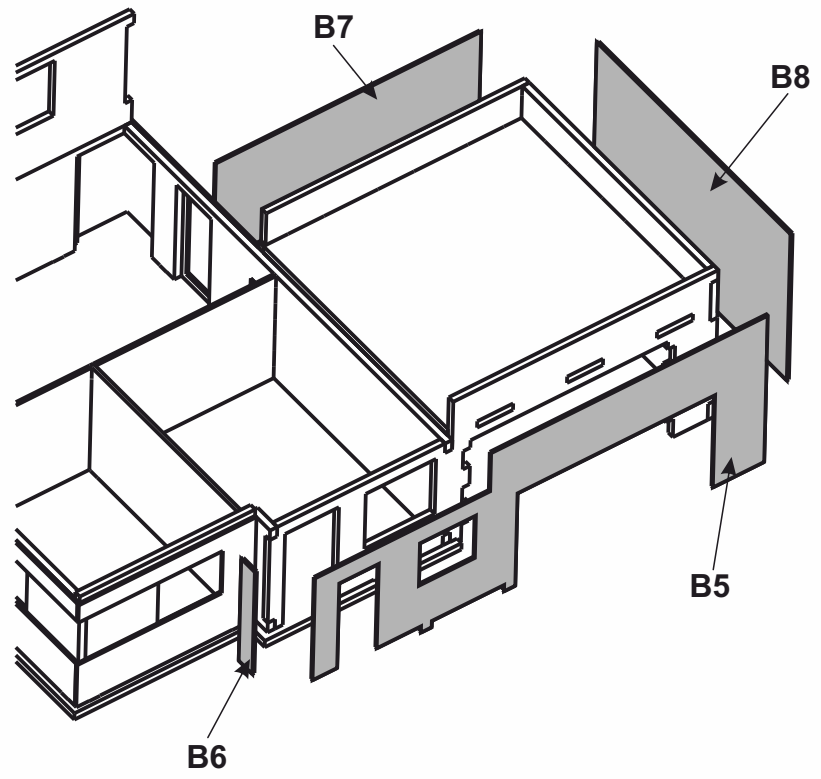

Bei der Montage mit Tor, kann das Fassadenteil B5 zusammenhängend aufgebracht werden. Die Aufhängungen werden nach der Verklebung gelöst.  
 When installing with a door, the façade part B5 can be glued on in one piece. The suspensions are detached after bonding.

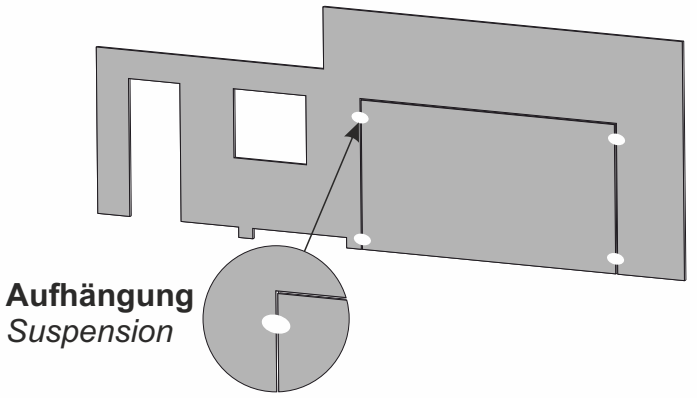

Aufhängung  
Suspension

6

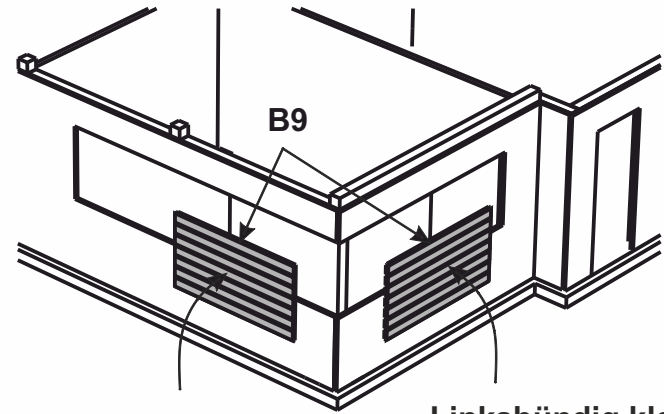

Rechtsbündig kleben!  
Glue right-justified.

Linksbündig kleben!  
Glue left-justified.

7

Montage Wand 1 OG / Mounting wall 1 first floor

A1 OG

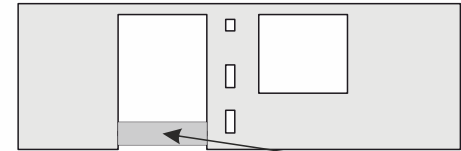

C1

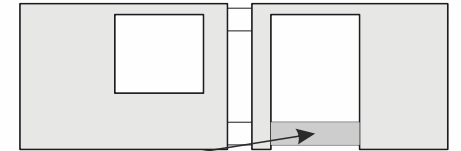

Montagestütze entfernen  
Remove mounting support

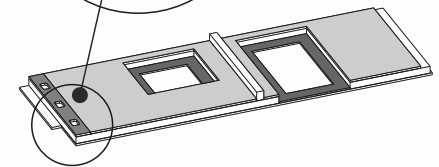
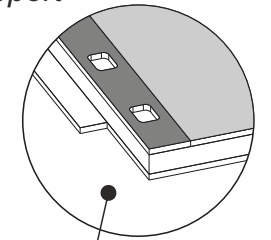
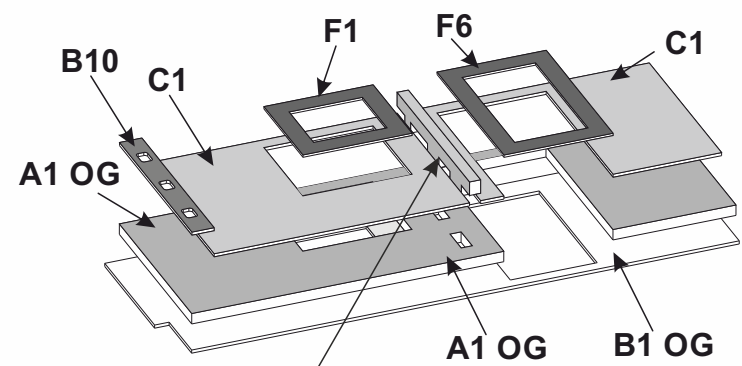

A13

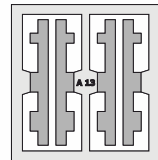

Bauteil A13 nicht kleben! Es wird als steckbare Anlagekante verwendet.  
Do not glue assembly part A13! It is used as insertable contact edge.



## ⑧ Montage Wand 2 OG / Mounting wall 2 first floor

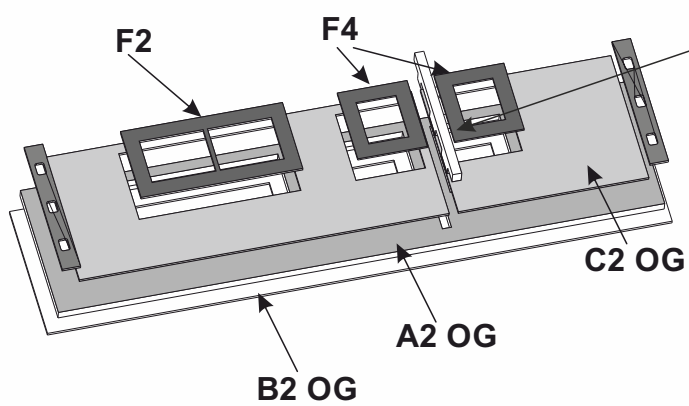

**Bauteil A13 nicht kleben! Es wird als steckbare Anlagekante verwendet.**  
*Do not glue assembly part A13! It is used as insertable contact edge.*

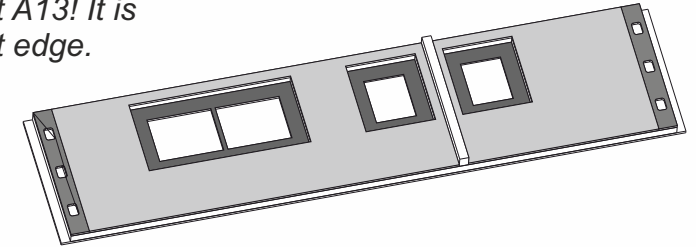

## ⑨ Montage Wand 4 OG / Mounting wall 4 first floor

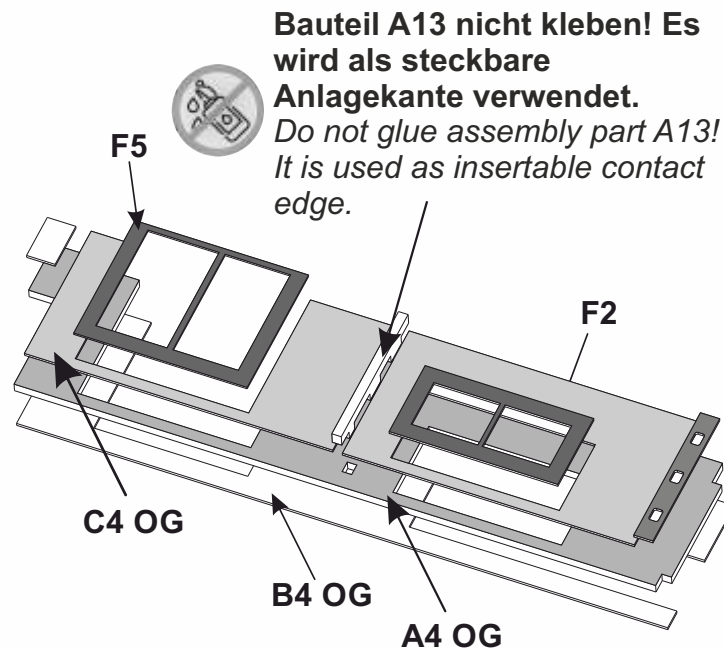

**Bauteil A13 nicht kleben! Es wird als steckbare Anlagekante verwendet.**  
*Do not glue assembly part A13! It is used as insertable contact edge.*

**B2 OG & B4 OG**

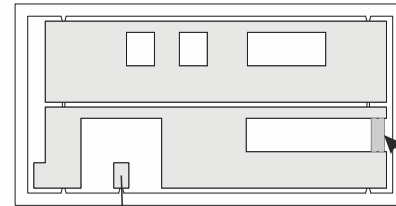

**C4**

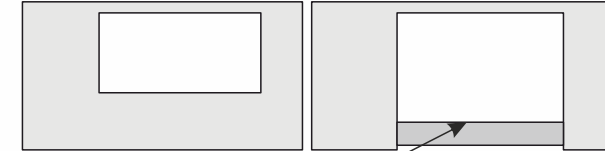

**A4 OG**

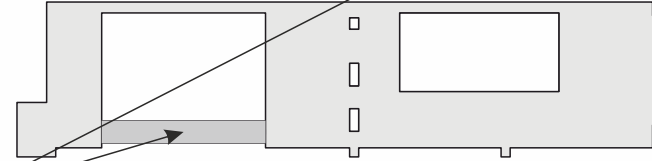

**Montagestütze entfernen**  
*Remove mounting support*

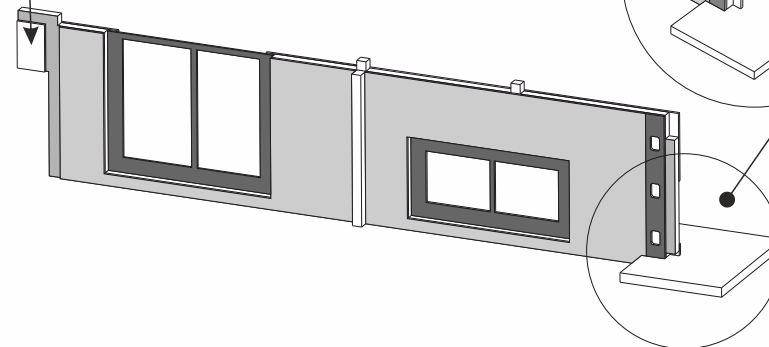

**Die Montagehilfe kann bei der Positionierung der Wände zur Hilfe genommen werden.**  
*The mounting aid can be used for positioning the walls.*

10

Wand 3  
Wall 3

A12

Wand 4  
Wall 4

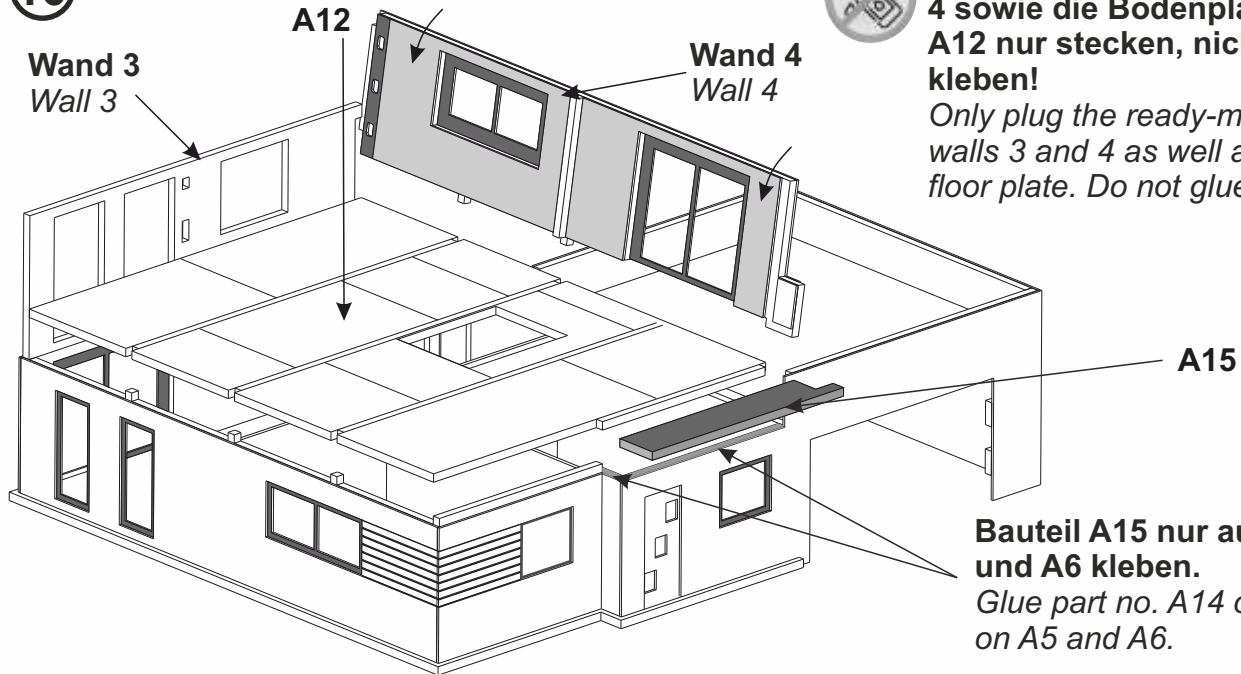

Die fertigen Wände 3 und 4 sowie die Bodenplatte A12 nur stecken, nicht kleben!  
 Only plug the ready-made walls 3 and 4 as well as the floor plate. Do not glue!

A15

Bauteil A15 nur auf A5 und A6 kleben.  
 Glue part no. A14 only on A5 and A6.

12



Bauteil A13 nicht kleben! Es wird als steckbare Anlegekante verwendet.  
 Do not glue assembly part A13! It is used as insertable contact edge.

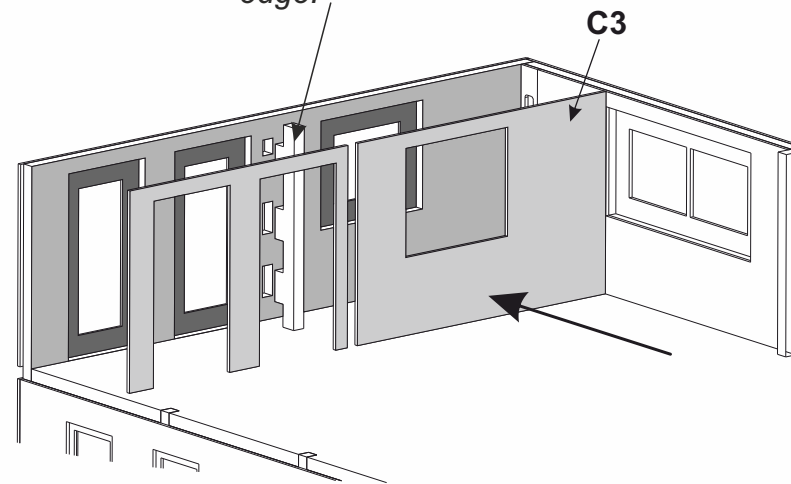

C3

11 Montage Wand 3 OG / Mounting wall 3 first floor

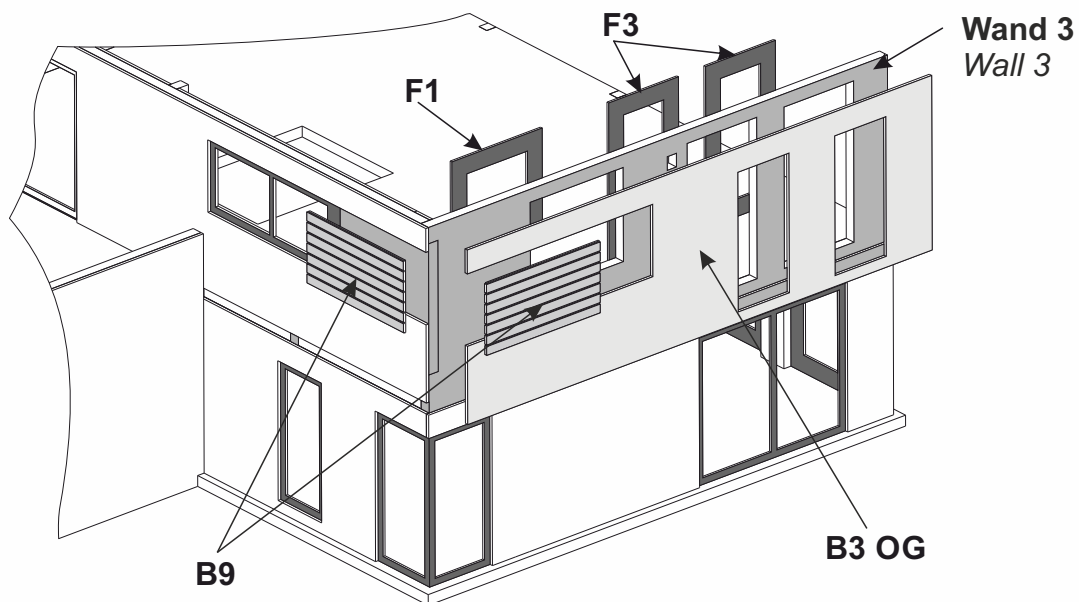

Wand 3  
Wall 3

F3

F1

B9

B3 OG

B3 OG

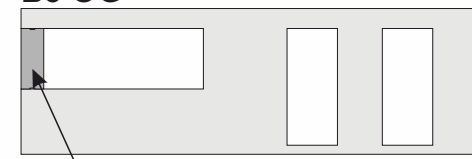

Montagestütze entfernen  
 Remove mounting support