

47556

POLYPLATE

N Werkstatt mit Ziegel-/Fachwerkfassade

N Workshop with brick/timber-framed facade

(DE)

Bitte legen Sie die Einzelteile nach Baugruppen zusammen und beginnen Sie dann entsprechend der Zeichnungen mit dem Zusammenbau.

1. Inhalt	1
2. Fenstermontage	3
3. Montage	4

(EN)

Arrange the individual parts by assembly groups, and then begin assembling in accordance with the drawings.

1. Contents	1
2. Mounting of the windows	3
3. Mounting	4

1. Inhalt / Contents

Baugruppe Assembly group	Teile-Nr. Part No.	Stück Pieces
A	1	1
	2	2
	3	1
	4	1
	5	1
B	1	2
	2	1
	3	1
	4	1
	5	1
	6	2
C	1	1
	2	1
	3	1
	4	1
	5	2
	6	1
	7a	1
	7b	1
D	1	1
	2	1
	3	1

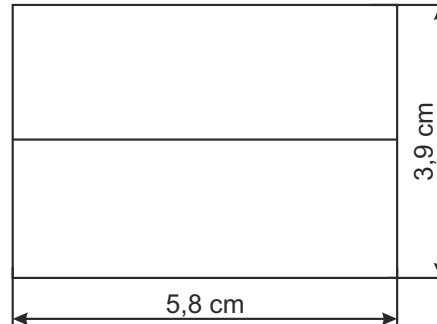

Plexiglas Fensterscheibe
Plexiglass window

(DE)

Dieser Bausatz besteht aus nachhaltigem Polyplate Verbundwerkstoff.

Für den Zusammenbau dieses hochwertigen Polyplate-Bausatzes empfehlen wir unseren kibri Polyplate Kleber, Art. 39997.

(EN)

This kit consists of sustainable Polyplate composite material.

For the assembly of this high-quality Polyplate kit, we recommend our kibri Polyplate glue, item 39997.

Baugruppe A / Assembly group A

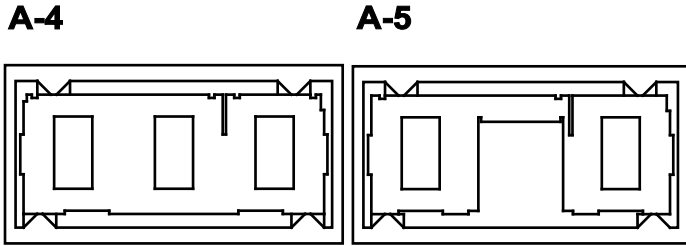
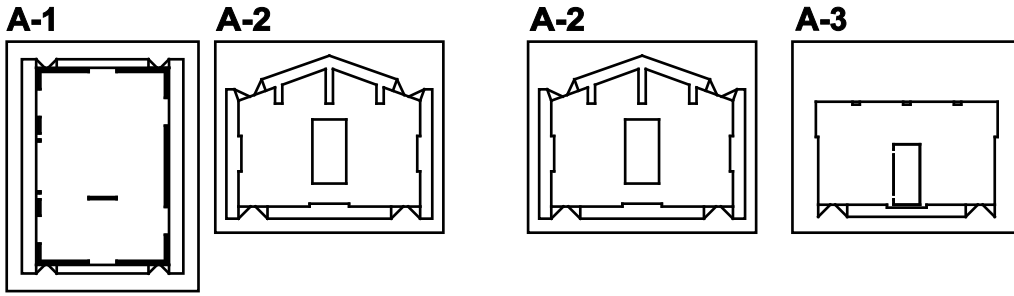

Baugruppe B / Assembly group B

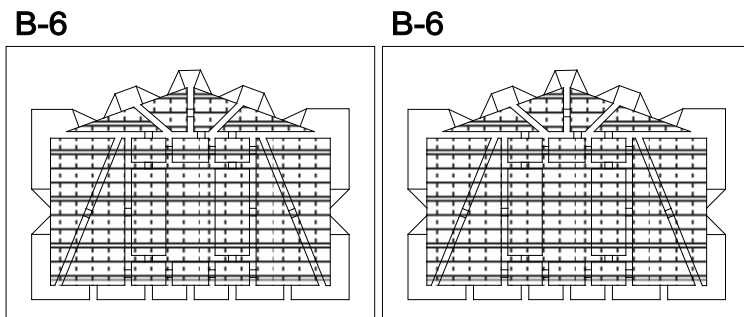
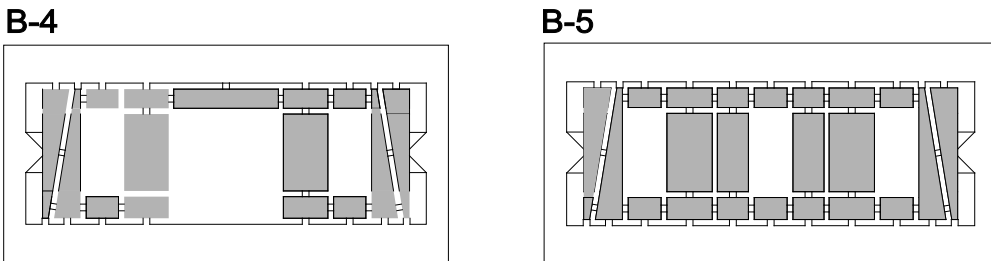
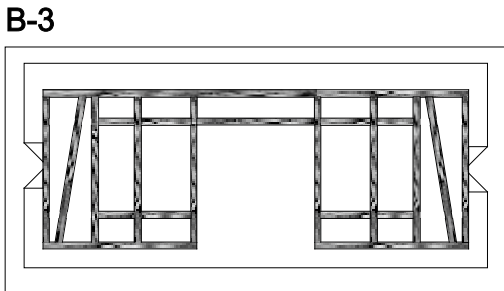
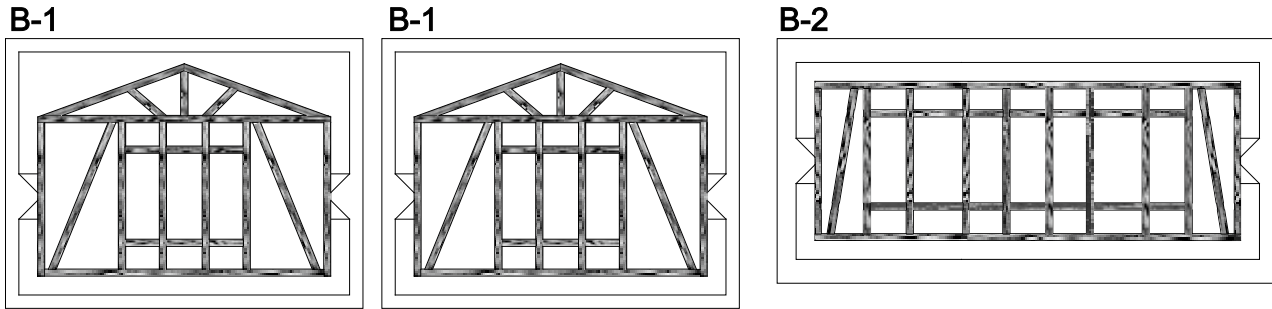

Baugruppe C / Assembly group C

C-1

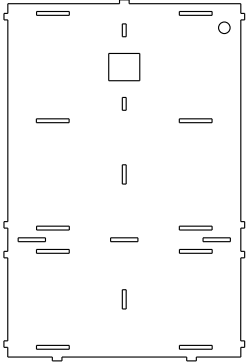

C-2

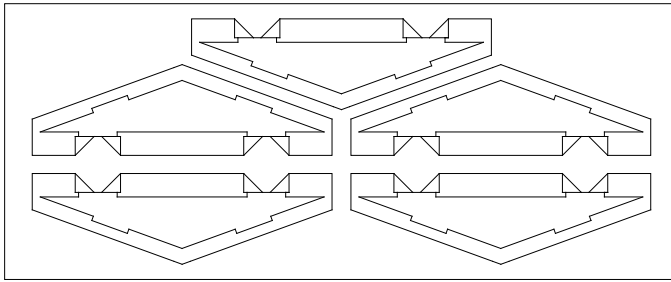

C-3

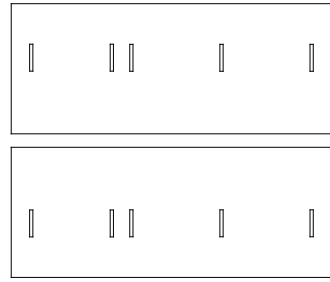

C-4

C-5

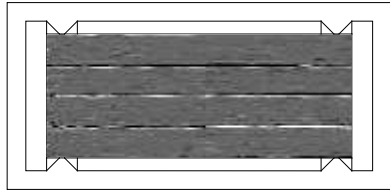

C-6

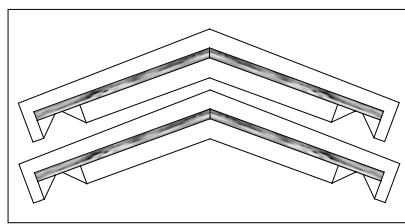

C-5

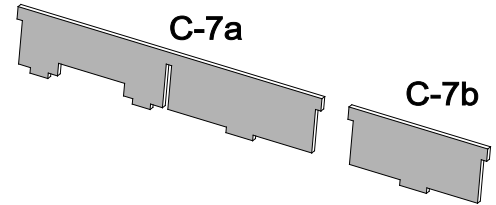
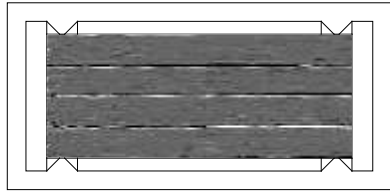

Baugruppe D / Assembly group D

D-1

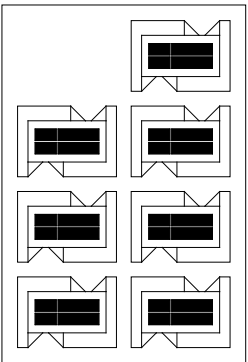

D-2

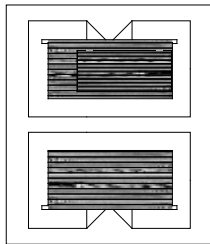

D-3

2. Fenstermontage / Mounting of the windows

Schutzfolie abziehen.
Remove protection foil.

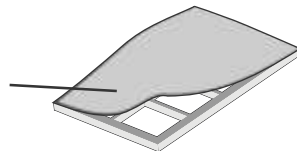

Mit der Klebeseite auf das Glas aufdrücken.
Press adhesive side onto the glass.

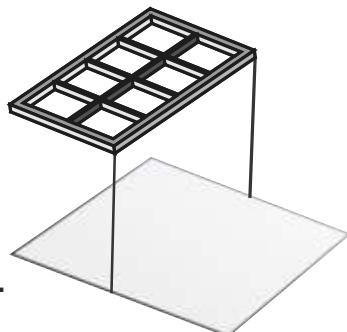

Am Rahmen ausschneiden.
Cut alongside the frame.

3. Montage / Mounting

①

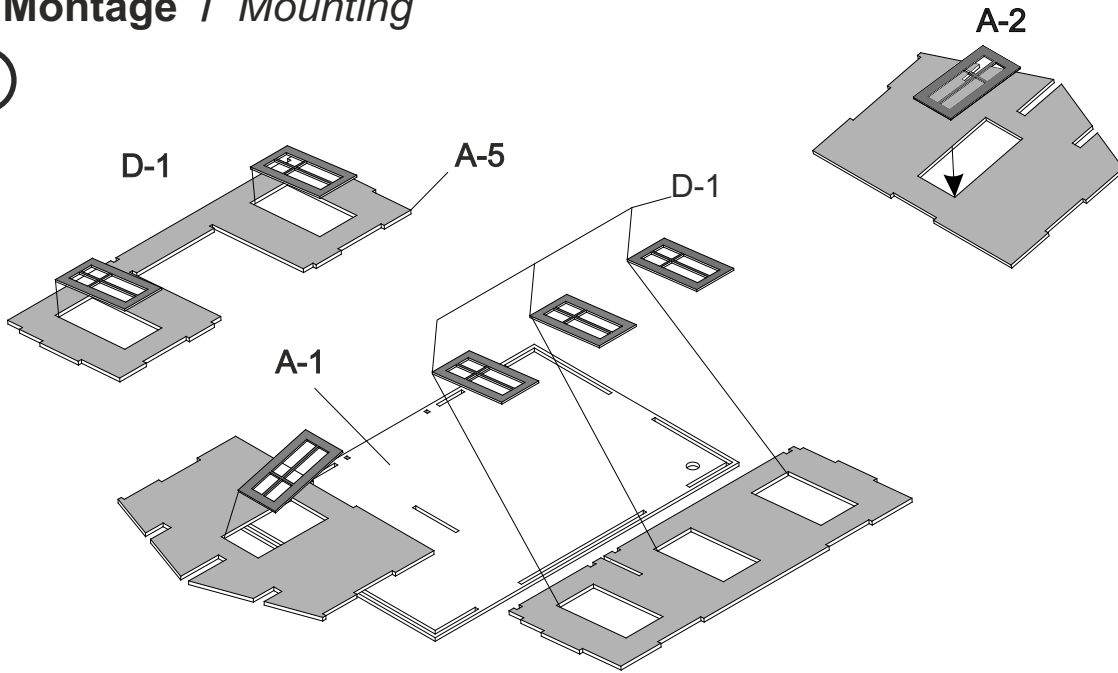

1. Wandteile plan auflegen.

2. Fertige Fenster innen einsetzen und am Rand mit etwas Klebstoff fixieren.

1. Lay the wall sections flat.

2. Insert finished windows from the inside and fasten at the edges with a little glue.

②

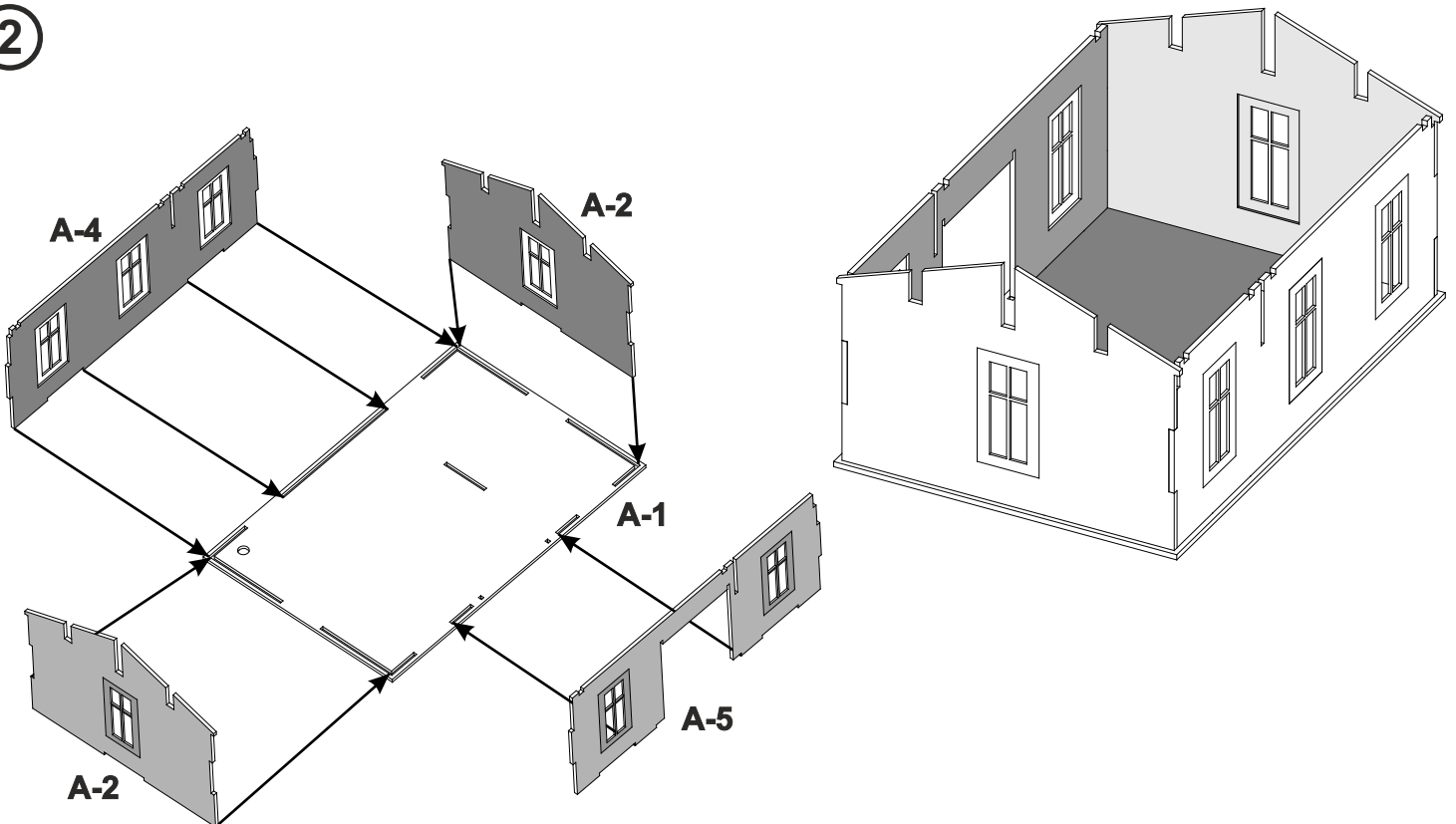

3

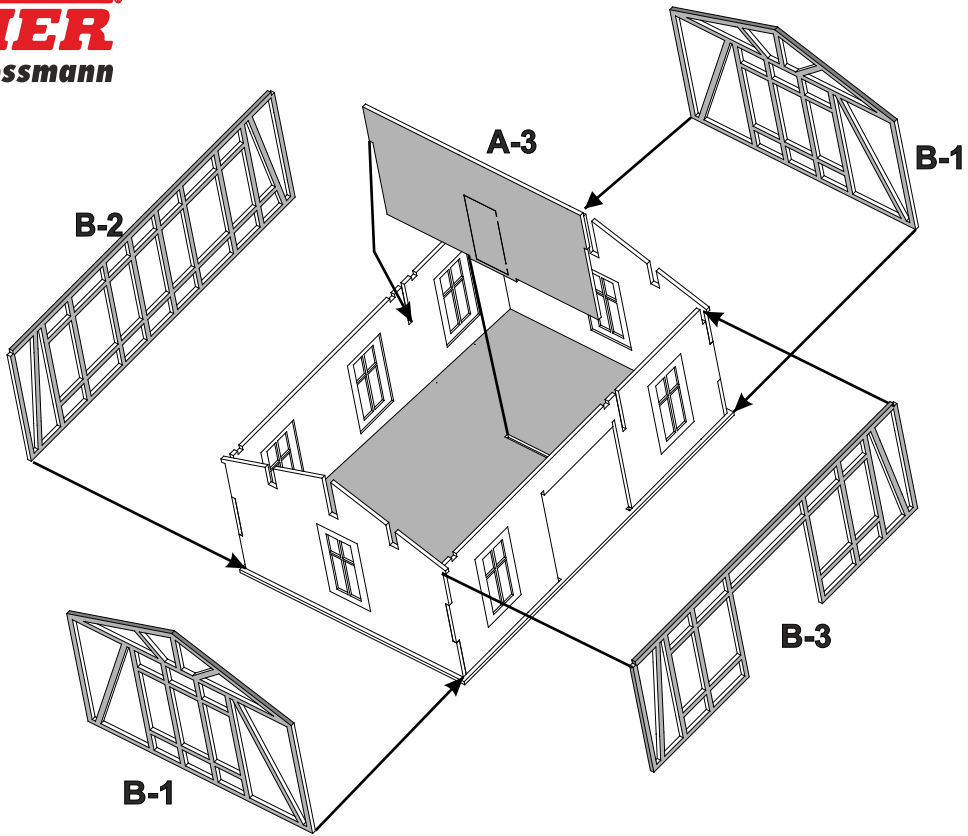

Fachwerk an den Zapfen am Giebel einsetzen, dabei zuerst das Teil B-3 montieren.

Insert framework at the gable's pins, starting with part B-3.

4

B-3

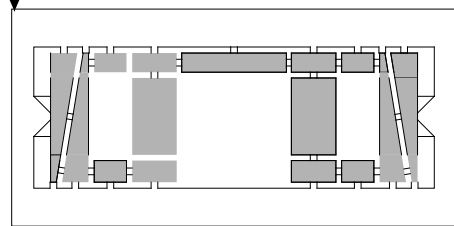
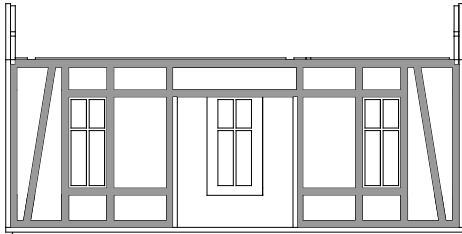

B-4 für B-3

B-2

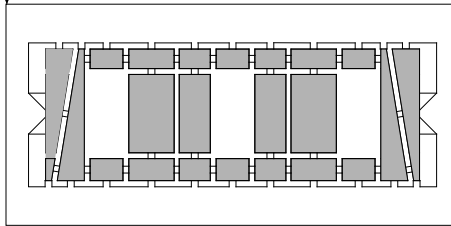
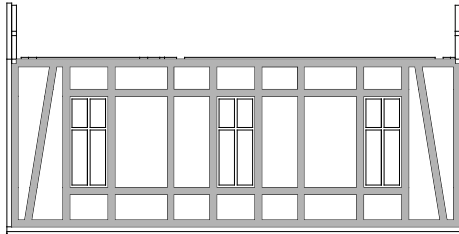

B-5 für B-2

B-1

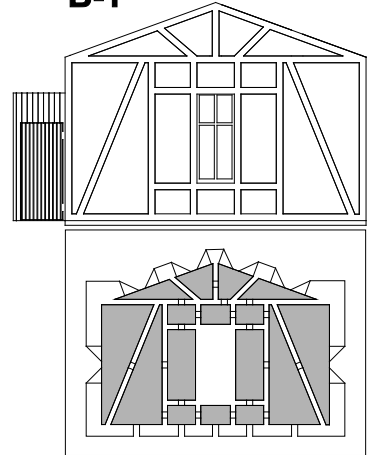

B-6 für B-1

B-1

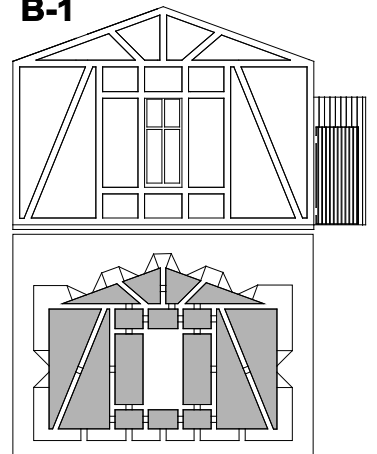

B-6 für B-1

1. Die Ziegelintarsien nach Muster einsetzen.
2. Nach Lösen aus der Bauteileplatte leichte Grate abschleifen.
3. Beim Einsetzen beachten: Die Intarsien sind spaltfrei geschnitten.

1. *Insert brick inlays acc. to pattern.*
2. *After removing from the component panel, grind off slight burrs.*
3. *Attention during insertion: The inlays are cut without gaps.*

5

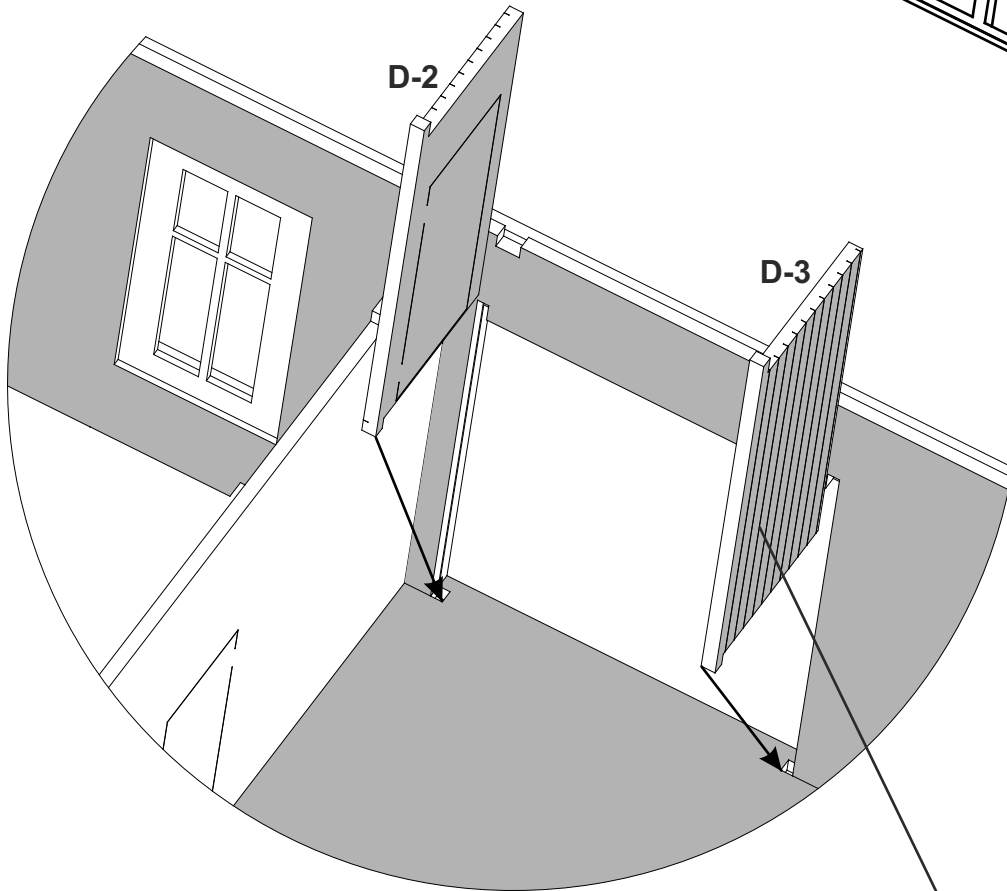
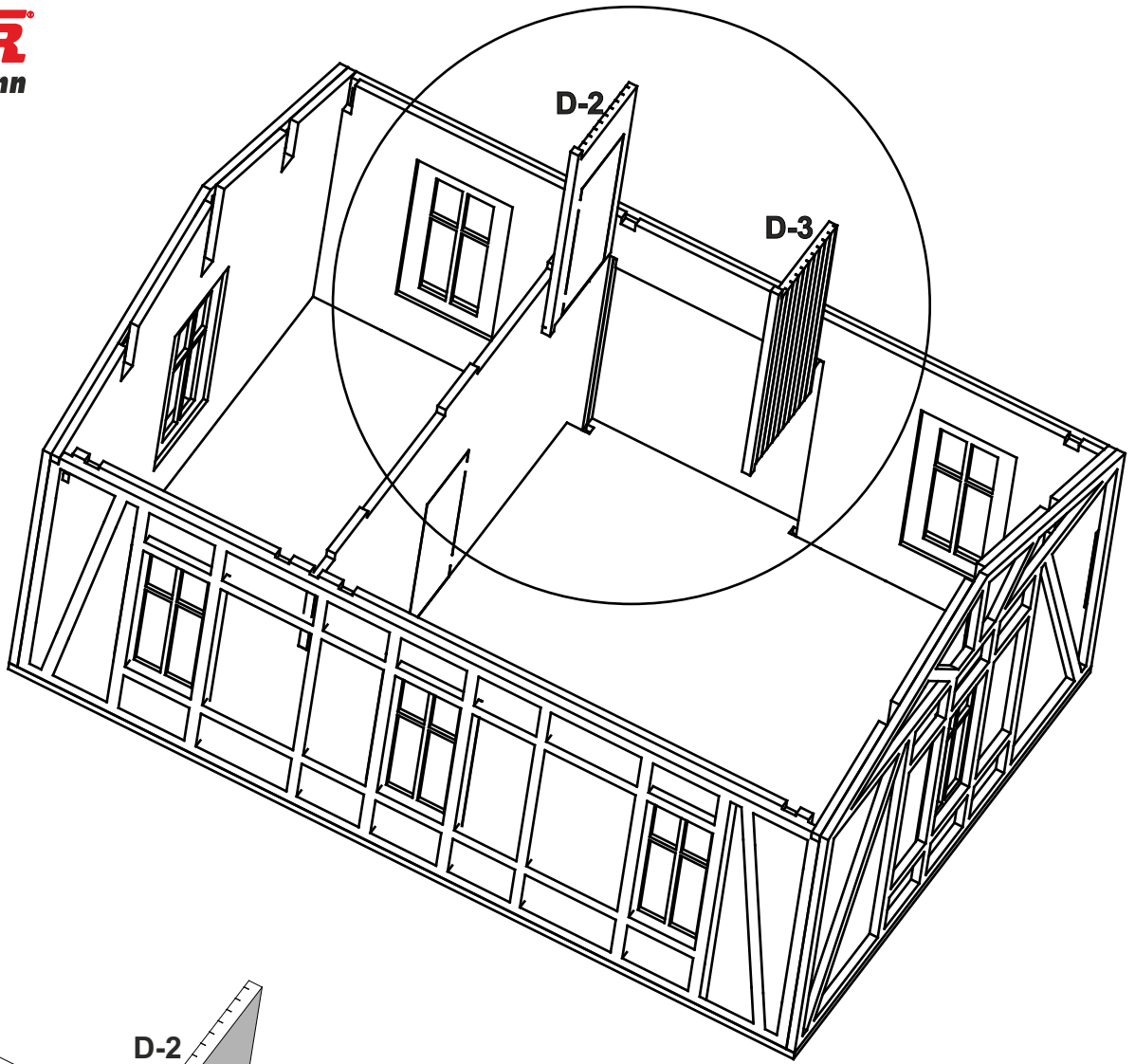

Torflügel offen oder geschlossen darstellbar.

Door leaf can be displayed open or closed.

6

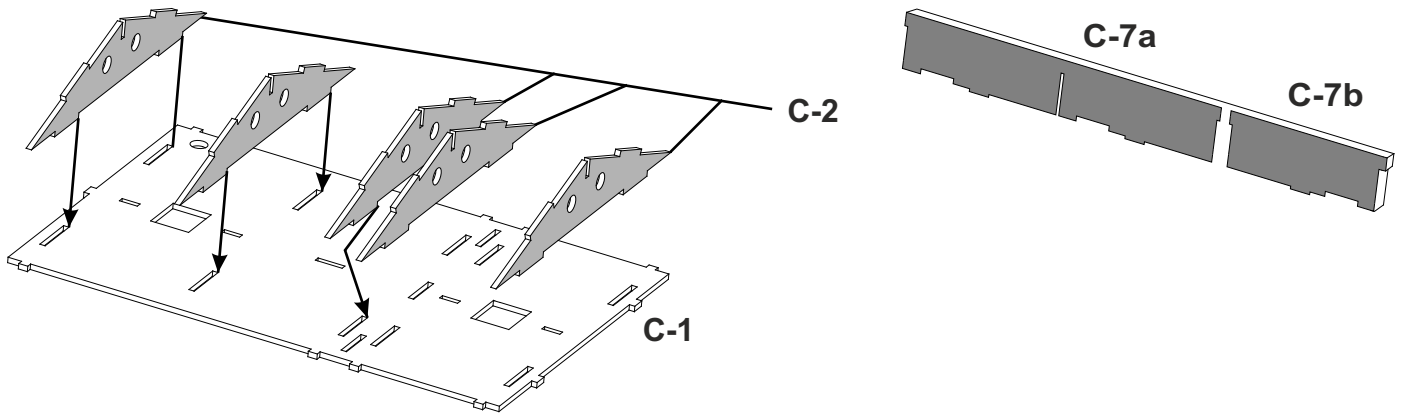

Montieren Sie die Bauteile C-2 auf das Bauteil C-1.
Bei gewünschter Beleuchtung, setzen Sie diese ein,
bevor die Bauteile C-7a und C-7b montiert werden.

Mount the components C-2 onto the
component C-1.
If lighting is desired, insert it, before
mounting components C-7a and C-7b.

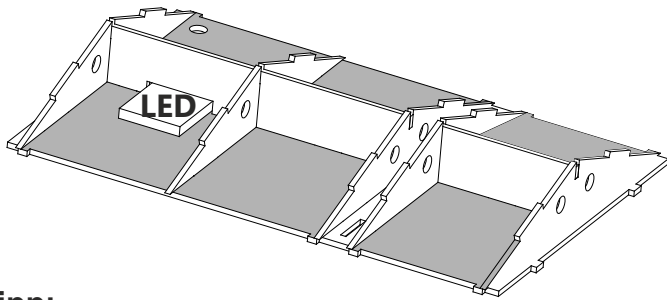

Tipp:
Zur Beleuchtung, verwenden Sie
viessmann LEDs für Etageninnenbeleuchtung,
z. B. Art. 6046 (warmweiß), Art. 6047 (gelb),
Art. 6048 (weiß).

Tip:
To illuminate, please use **viessmann**
LEDs for floor interior lighting, e. g.
item 6046 (warm-white), item 6047 (yellow),
item 6048 (white).

7

Kabeldurchlass
Cable outlet

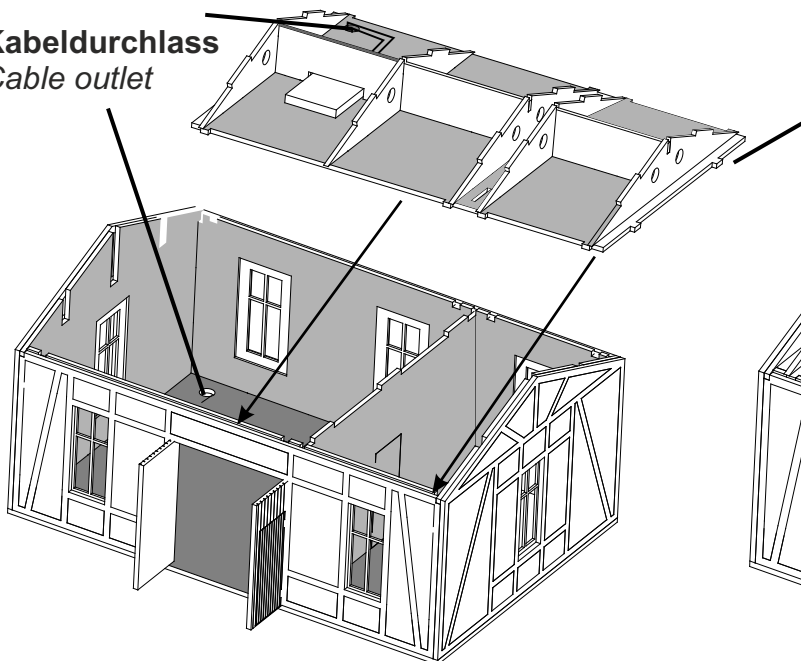

Dachkonstruktion einsetzen, wahlweise
einkleben oder abnehmbar lassen!

Insert roof construction, optionally
fasten with glue or leave detachable!

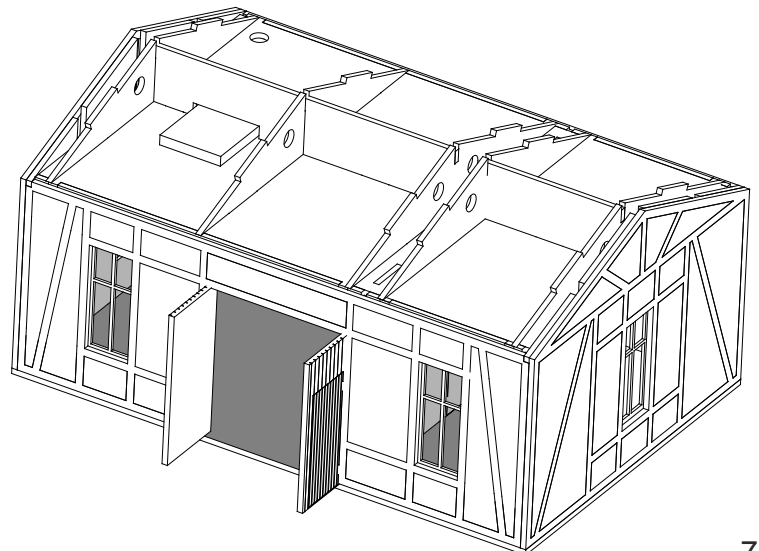

8

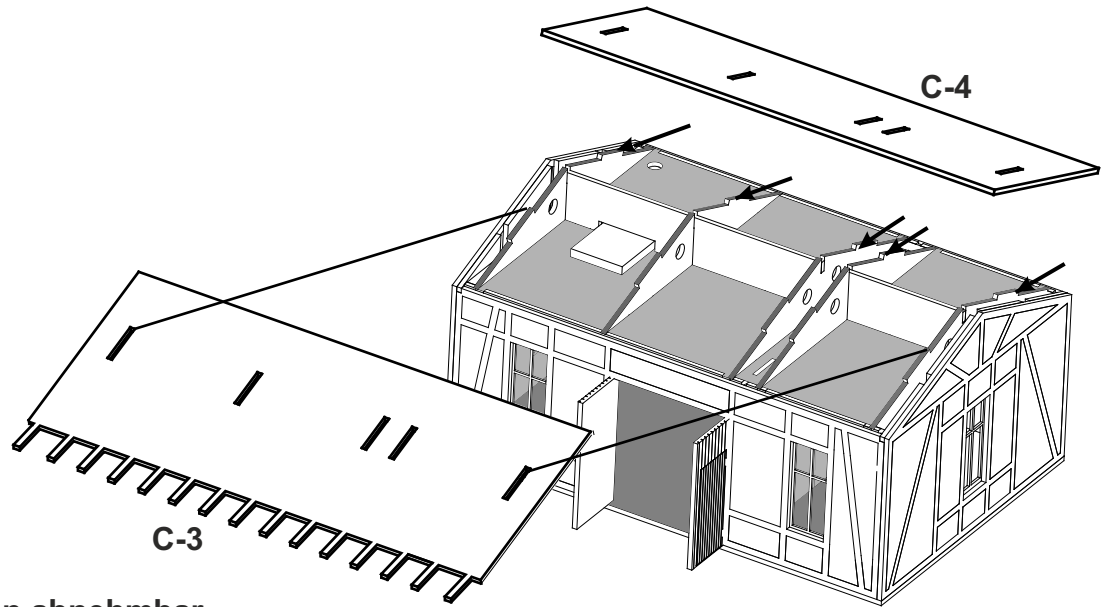

Um die Dachkonstruktion abnehmbar zu lassen, C-3 und C-4 nur auf den markierten Kanten kleben!
In order to leave the roof construction detachable, apply glue to the marked edges of C-3 and C-4 only!

9

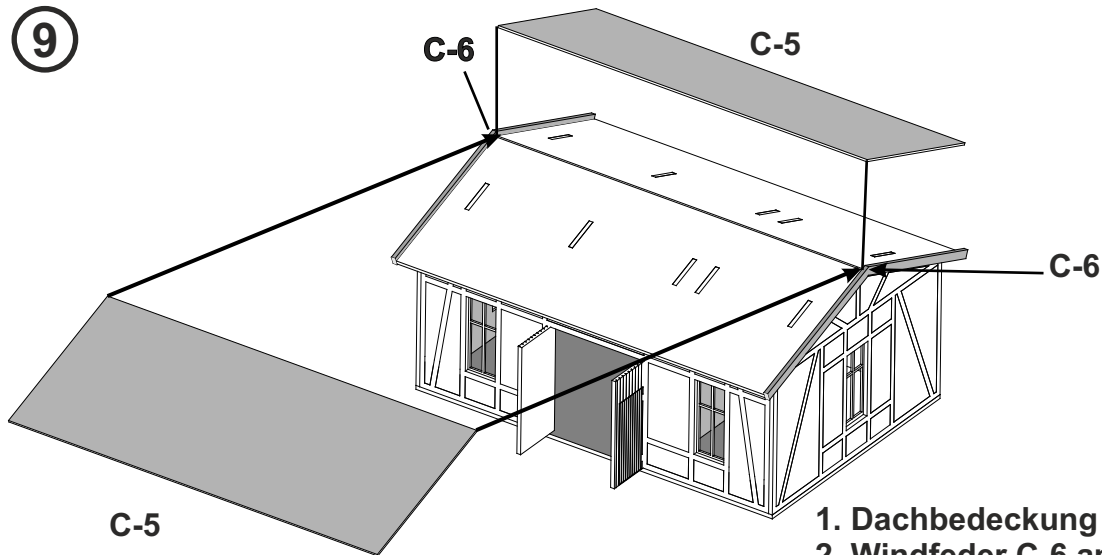

- 1. Dachbedeckung C-5 flächig aufkleben.**
 - 2. Windfeder C-6 am Dachüberstand ankleben.**
- 1. Glue roofing C-5 flat on.
2. Then glue wind spring C-6 to the roof overhang.*

