

HOUSING	OPERATING DISTANCE	MOUNTING	✓ Long sensing range	✓ Exceptional price-performance ratio
M30	20 mm	Quasi-embeddable	✓ Outstanding accuracy and temperature stability	✓ Current or voltage output
			✓ Resolution in μm range	✓ IP67

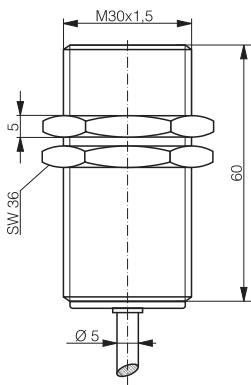

DW-AD-509-M30-390

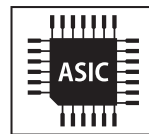
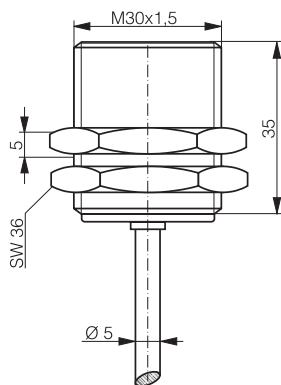

DW-AD-509-M30-320

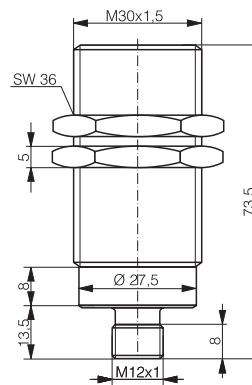

DW-AS-509-M30-390

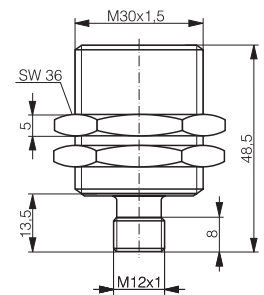

DW-AS-509-M30-320

DETECTION DATA		INTERFACE	
Sensing distance (S_d)	20 mm	IO-Link	✗
Repeat accuracy (IEC 60947-5-2)	± 0.02 mm	MTTF (@40°C)	546 y
Static resolution* (@0.67· S_d)	≤ 0.41 μm		
Dynamic resolution* (@0.67· S_d)	≤ 1.55 μm		
Temperature drift of S_d	$\leq 5\%$ (0... +70°C) $\leq 10\%$ (-25... 0°C)		
Standard target	60 x 60 x 1 mm ³ , FE360		

*Static resolution is measured when the target is moving at 20 Hz. Dynamic resolution when the target is moving at 1 kHz.

ELECTRICAL DATA		MECHANICAL DATA	
Supply voltage range (U_B)	15...30 VDC	Mounting	Quasi-embeddable
Residual ripple	$\leq 20\%$ U_B	Housing material	Chrome-plated brass
Power consumption (no-load)	≤ 12 mA	Sensing face material	PBTP
Max. load at voltage output	≤ 15 mA	Max tightening torque	70 Nm
Max. load at current output	0.4k Ω ($U_B=15\text{V}$) / 1k Ω ($U_B=30\text{V}$)	Ambient operating temperature	-25...+70°C
Bandwidth	200 Hz	Enclosure rating	IP67
Time delay before availability	20 ms	Weight (cable / connector)	see page 2
Recovery time	50 ms	Shock and vibration	IEC 60947-5-2 / 7.4
Short-circuit protection	✓		
Voltage reversal protection	✓		
Cable length max.	≤ 300 m		

Note: all data measured according to IEC 60947-5-2 standard with $U_B=20 \dots 30\text{VDC}$, $T_A=23^\circ\text{C} \pm 5^\circ\text{C}$.

CORRECTION FACTORS

Steel FE 360	1	Copper	0.28	Aluminum	0.32	Brass	0.4	Stainless S. V2A 1 / 2 mm	0.7
--------------	---	--------	------	----------	------	-------	-----	---------------------------	-----

Note: the operating distance of the sensor must be multiplied by the correction factor of the material. For example, the operating distance on Aluminum is $S_{n,Al} = S_n \times CF_{Al}$. In case of embeddable mounting, the distance is multiplied by the additional correction factor of the support, thus $S_{n,Al} = S_n \times CF_{Al} \times CF_{emb,Al}$.

INSTALLATION CONDITIONS

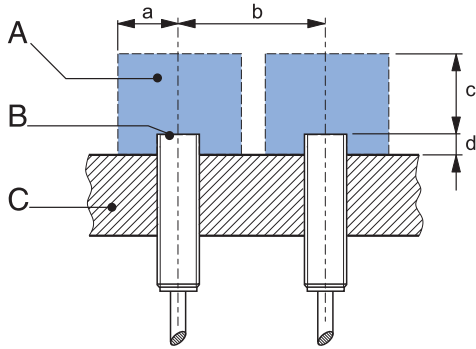

- A : metal free zone a : 35 mm
 B : sensing face b : 80 mm
 C : support c : 60 mm
 d : steel 4 mm

Note: additional installation information can be found in the glossary of the Contrinex General Catalog.

RESPONSE DIAGRAM

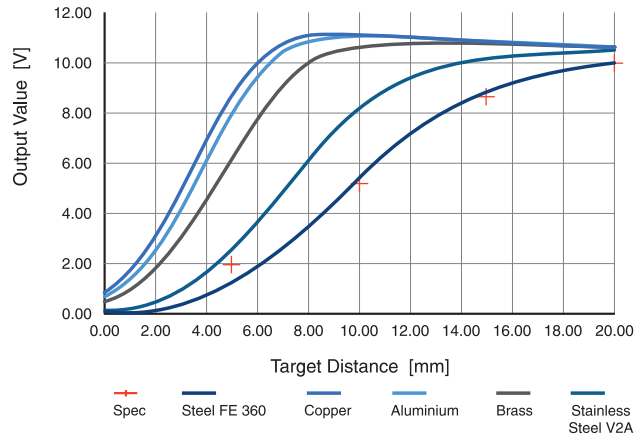

Output voltage	s = 0 mm	0 V / -0.0 +0.4 V	Output current	s = 0 mm	4 mA ± 0.8 mA
	s = $S_d/2$ mm	+5.2 V ± 0.4 V		s = $S_d/2$ mm	12.3 mA ± 0.8 mA
	s = S_d mm	+10.0 V ± 0.4 V		s = S_d mm	20 mA ± 0.8 mA
	s > S_d mm	+10 ... 12 V ± 0.4 V		s > S_d mm	+20 ... 23 mA ± 0.8 mA

WIRING DIAGRAM

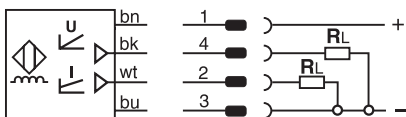

PIN ASSIGNMENT

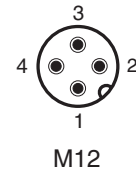

AVAILABLE TYPES

Part number	Part reference	Connection	Output on pin 2 / wh	Output on pin 4 / bk	Weight
330-020-417	DW-AD-509-M30-320	PUR, 2 m, 4 wire	4...20 mA	0...10 V	190 g
330-020-418	DW-AD-509-M30-390	PUR, 2 m, 4 wire	4...20 mA	0...10 V	215 g
330-020-446	DW-AS-509-M30-320	M12 4-pin	4...20 mA	0...10 V	135 g
330-020-447	DW-AS-509-M30-390	M12 4-pin	4...20 mA	0...10 V	155 g

Note: part reference may include additional suffix to indicate a revision version or special version. Further information is available on request.

Operators of the products we supply are responsible for compliance with measures for the protection of persons. The use of our equipment in applications where the safety of persons might be at risk is only authorized if the operator observes and implements separate, appropriate and necessary measures for the protection of persons and machines. Terms of delivery and rights to change design reserved.