

HOUSING	OPERATING DISTANCE	MOUNTING	✓ One-piece housing in stainless steel V2A	✓ Extremely robust
M18	10 mm	Embeddable	✓ Long operating distance	✓ Water resistant
			✓ Factor 1 on Fe and Al	✓ IP68/IP69K
				✓ IO-Link v1.1

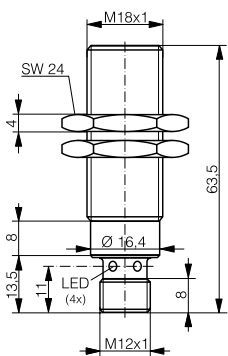

DW-AS-70x-M18-002

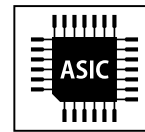
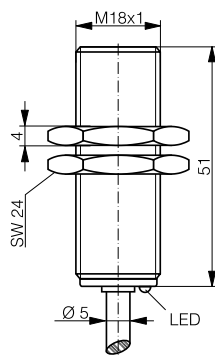

DW-AD-70x-M18

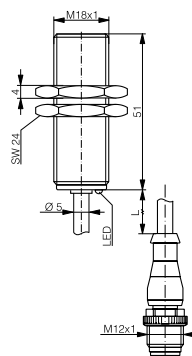

DW-AV-70x-M18-276

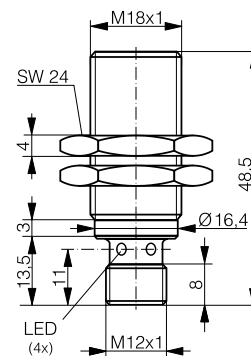

DW-AS-70x-M18-120

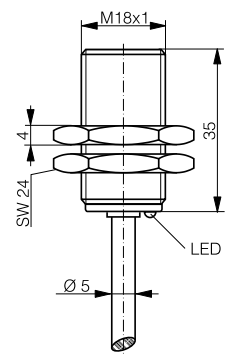

DW-AS-70x-M18-120

DETECTION DATA		INTERFACE	
Rated operating distance ( $S_n$ )	10 mm	Indicator LED, yellow	Sensing state ( $0 \leq s \leq 0.8 S_r$ )
Assured operating distance ( $S_a$ )	$\leq (0.81 \times S_n)$ mm	Indicator LED, yellow, blinking	Sensing state ( $0.8 S_r < s \leq S_r$ )
Repeat accuracy	$\leq 0.3$ mm	IO-Link	✓
Hysteresis	$3\% S_r < \text{Hyst} \leq 15\% S_r$	MTTF (@40°C)	1028 y
Temperature drift	$\leq 10\% S_r$		
Standard target	30 x 30 x 1 mm <sup>3</sup> , FE360		

Note:  $0.9S_n \leq S_a \leq 1.1S_n$ .

ELECTRICAL DATA		MECHANICAL DATA	
Supply voltage range ( $U_B$ )	10...30 VDC	Mounting	Embeddable
Residual ripple	$\leq 20\% U_B$	Housing material	V2A / 1.4305 / AISI 303
Output current	$\leq 200$ mA	Sensing face material	V2A / 1.4305 / AISI 303
Output voltage drop	$\leq 2.0$ VDC	Max tightening torque	50 Nm
Power consumption (no-load)	$\leq 10$ mA	Ambient operating temperature	-25...+85°C <sup>1</sup>
Residual current	$\leq 0.1$ mA	Enclosure rating	IP68 / IP69K
Switching frequency	$\leq 200$ Hz	Weight (cable/connector)	see page 2
Short-circuit protection	✓	Shock and vibration	IEC 60947-5-2 / 7.4
Voltage reversal protection	✓		
Cable length max.	$\leq 300$ m		

<sup>1</sup>Maximum temperature according to UL: 70°C.

Note: all data measured according to IEC 60947-5-2 standard with  $U_B=20 \dots 30$ VDC,  $T_A=23^\circ\text{C} \pm 5^\circ\text{C}$ .

## CORRECTION FACTORS FOR TARGET OF

Steel FE 360	1	Copper	0.8	Aluminum	1	Brass	1.2	Stainless Steel V2A 1/2 mm	0.5 / 0.9
--------------	---	--------	-----	----------	---	-------	-----	----------------------------	-----------

## CORRECTION FACTORS FOR EMBEDDABLE MOUNTING IN SUPPORT OF

Steel FE 360	0.75	Aluminum	0.9	Brass	0.75	Stainless Steel V2A	0.8
--------------	------	----------	-----	-------	------	---------------------	-----

Note: the operating distance of the sensor must be multiplied by the correction factor of the material. For example, the operating distance on Aluminum is  $S_{n,Al} = S_n \times CF_{Al}$ . In case of embeddable mounting, the distance is multiplied by the additional correction factor of the support, thus  $S_{n,Al} = S_n \times CF_{Al} \times CF_{emb,Al}$ .

## INSTALLATION CONDITIONS

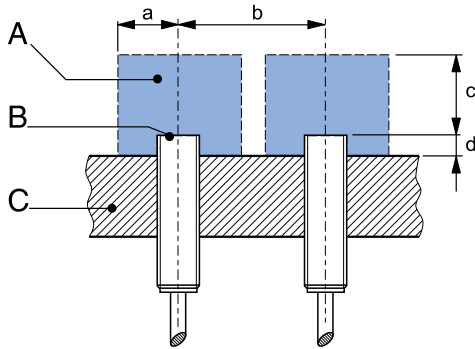

A : metal free zone      a : 25 mm      d : steel 0 mm  
 B : sensing face      b : 50 mm  
 C : support      c : 30 mm

Note: additional installation information can be found in the glossary of the Contrinex General Catalog.

## IO-LINK FUNCTIONALITIES

IO-Link version	1.1
SIO mode	Supported
Process data	7-bit input
Baudrate	COM2 (38.4 kBaud)
Minimum cycle time	10.4 ms
ISDU	Not supported



IODD files may be downloaded from

[www.contrinex.com/product-range/inductive-sensors/](http://www.contrinex.com/product-range/inductive-sensors/).

Select the product name to display the product page with corresponding downloads.

Alternatively, just click/scan the QR code on the left.

## WIRING DIAGRAM

## PIN ASSIGNMENT

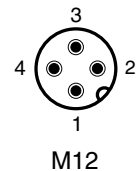
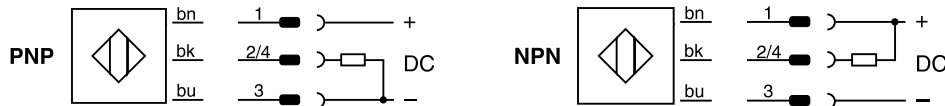

## AVAILABLE TYPES

Part number	Part reference	Polarity	Connection	Output on pin 2	Output on pin 4 / bk	Weight
320-420-221	DW-AD-701-M18	NPN	PUR, 2 m, 3 wire	-	Normally open (NO)	115 g
320-420-222	DW-AD-702-M18	NPN	PUR, 2 m, 3 wire	Normally close (NC)	-	115 g
330-320-014	DW-AD-703-M18	PNP	PUR, 2 m, 3 wire	-	Normally open (NO) / IO-Link	115 g
320-420-224	DW-AD-704-M18	PNP	PUR, 2 m, 3 wire	Normally close (NC)	-	115 g
320-420-538	DW-AD-701-M18-120	NPN	PUR, 2 m, 3 wire	-	Normally open (NO)	106 g
320-420-539	DW-AD-702-M18-120	NPN	PUR, 2 m, 3 wire	Normally close (NC)	-	106 g
330-320-079	DW-AD-703-M18-120	PNP	PUR, 2 m, 3 wire	-	Normally open (NO) / IO-Link	106 g
320-420-541	DW-AD-704-M18-120	PNP	PUR, 2 m, 3 wire	Normally close (NC)	-	106 g
320-420-226	DW-AS-701-M18-002	NPN	M12 4-pin	-	Normally open (NO)	53 g
320-420-227	DW-AS-702-M18-002	NPN	M12 4-pin	Normally close (NC)	-	53 g
330-320-015	DW-AS-703-M18-002	PNP	M12 4-pin	-	Normally open (NO) / IO-Link	53 g
320-420-229	DW-AS-704-M18-002	PNP	M12 4-pin	Normally close (NC)	-	53 g
320-420-542	DW-AS-701-M18-120	NPN	M12 4-pin	-	Normally open (NO)	47 g
320-420-543	DW-AS-702-M18-120	NPN	M12 4-pin	Normally close (NC)	-	47 g
330-320-080	DW-AS-703-M18-120	PNP	M12 4-pin	-	Normally open (NO) / IO-Link	46 g
320-420-545	DW-AS-704-M18-120	PNP	M12 4-pin	Normally close (NC)	-	47 g
320-420-052	DW-AV-701-M18-276	NPN	PUR, 0.2 m + M12 4-pin	-	Normally open (NO)	60 g
330-320-077	DW-AV-703-M18-276	PNP	PUR, 0.2 m + M12 4-pin	-	Normally open (NO) / IO-Link	67 g

Operators of the products we supply are responsible for compliance with measures for the protection of persons. The use of our equipment in applications where the safety of persons might be at risk is only authorized if the operator observes and implements separate, appropriate and necessary measures for the protection of persons and machines. Terms of delivery and rights to change design reserved.