

HOUSING	OPERATING DISTANCE	MOUNTING	✓ Resistant up to 500 bar	✓ Peaks ≤ 1000 bar
M12	1.5 mm	Embeddable	✓ Exceptionally long life	✓ Ceramic sensing face
			✓ Long operating distance	✓ Gas tight, IP68
			✓ Large temperature range	✓ IO-Link v1.1

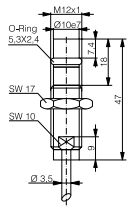

DW-AD-50x-P12-625

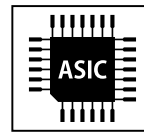
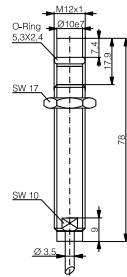

DW-AD-50x-P12-627

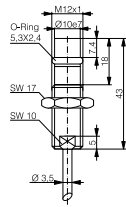

DW-AD-50x-P12-639

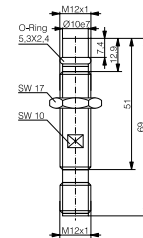

DW-AS-50x-P12

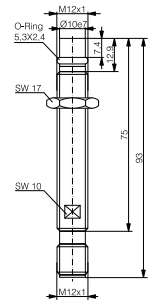

DW-AS-50x-P12-621

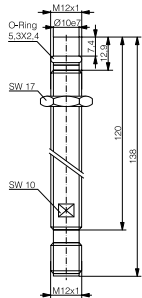

DW-AS-50x-P12-622

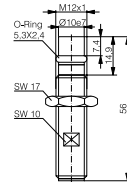

DW-AS-50x-P12-624

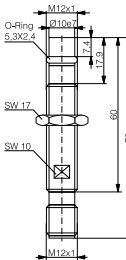

DW-AS-50x-P12-627

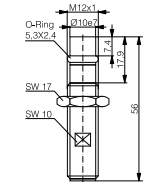

DW-AS-50x-P12-630

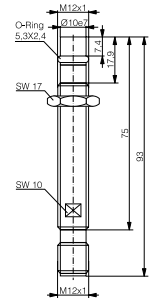

DW-AS-50x-P12-635

DETECTION DATA		INTERFACE	
Rated operating distance (S _n)	1.5 mm	Indicator LED, yellow	✗
Assured operating distance (S _a)	≤ (0.81 x S _n) mm (-25 ... +70 °C)	Indicator LED, yellow, blinking	✗
Repeat accuracy	≤ 0.1 mm	IO-Link	✓
Hysteresis	3% S _n ≤ Hyst ≤ 15% S _n	MTTF (@40°C)	949 y
Temperature drift	≤ 10 % (-25 ... +70°C) ≤ 15 % (+70 ... +100°C)		
Standard target	10 x 10 x 1 mm ³ , FE360		

Note: 0.9S_n ≤ S_a ≤ 1.1S_n.

ELECTRICAL DATA		MECHANICAL DATA	
Supply voltage range (U_B)	10...30 VDC	Operating pressure	≤ 500 bar
Residual ripple	≤ 20% U_B	Peak pressure	≤ 1000 bar
Output current	≤ 200 mA	Vacuum down to	10 ⁻⁸ Torr
Output voltage drop	≤ 2.0 VDC	Mounting	Embeddable
Power consumption (no-load)	≤ 10 mA	Housing material	Stainless-steel DIN 1.4305 / AISI 303
Residual current	≤ 0.1 mA	Sensing face material	ZrO ₂
Switching frequency	≤ 600 Hz	Max tightening torque	40 Nm
Short-circuit protection	✓	Ambient operating temperature	-25...+100°C ¹
Voltage reversal protection	✓	Enclosure rating	IP 68
Cable length max.	≤ 300 m	Weight (cable / connector)	see page 3
		Shock and vibration	IEC 60947-5-2 / 7.4

¹Maximum temperature according to UL: 70°C.

Note: all data measured according to IEC 60947-5-2 standard with $U_B = 20 \dots 30VDC$, $T_A = 23°C \pm 5°C$.

CORRECTION FACTORS									
Steel FE 360	1	Copper	0.12	Aluminum	0.2	Brass	0.34	Stainless S. V2A 1 / 2 mm	0.75

Note: the operating distance of the sensor must be multiplied by the correction factor of the material. For example, the operating distance on Aluminum is $S_{n,Al} = S_n \times CF_{Al}$. In case of embeddable mounting, the distance is multiplied by the additional correction factor of the support, thus $S_{n,Al} = S_n \times CF_{Al} \times CF_{emb,Al}$.

INSTALLATION CONDITIONS

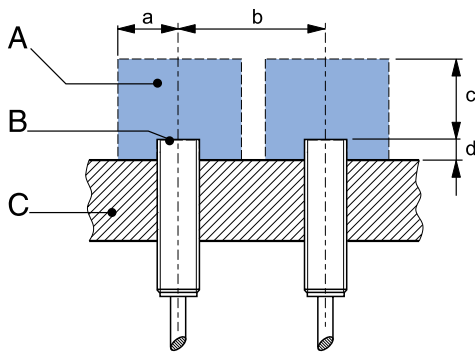

A : metal free zone a : 6 mm d : steel 0 mm
 B : sensing face b : 12 mm
 C : support c : 4.5 mm

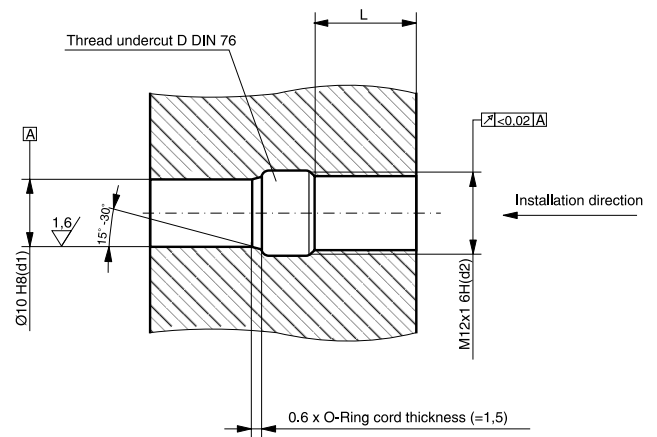

Note: additional installation information can be found in the glossary of the Contrinex General Catalog.

L : recommended installation depth: $L \geq 0.8 \times d2$

IO-LINK FUNCTIONALITIES

IO-Link version	1.1
SIO mode	Supported
Process data	7-bit input
Baudrate	COM2 (38.4 kBaud)
Minimum cycle time	10.4 ms
ISDU	Not supported



IO-Link files may be downloaded from

www.contrinex.com/product-range/inductive-sensors/.

Select the product name to display the product page with corresponding downloads.

Alternatively, just click/scan the QR code on the left.

WIRING DIAGRAM PIN ASSIGNMENT

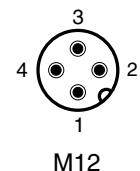
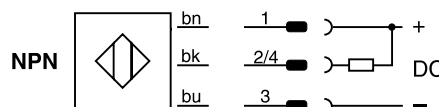
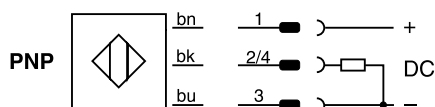

AVAILABLE TYPES

Part number	Part reference	Polarity	Connection	Output on pin 2	Output on pin 4 / bk	Weight
330-020-174	DW-AD-503-P12-625	PNP	PUR, 2 m, 3 wire	-	Normally open (NO) / IO-Link	51 g
330-020-175	DW-AD-503-P12-627	PNP	PUR, 2 m, 3 wire	-	Normally open (NO) / IO-Link	65 g
330-020-176	DW-AD-503-P12-639	PNP	PUR, 2 m, 3 wire	-	Normally open (NO) / IO-Link	50 g
330-020-177	DW-AD-504-P12-625	PNP	PUR, 2 m, 3 wire	-	Normally close (NC)	51 g
330-020-178	DW-AD-504-P12-627	PNP	PUR, 2 m, 3 wire	-	Normally close (NC)	65 g
330-020-179	DW-AD-504-P12-639	PNP	PUR, 2 m, 3 wire	-	Normally close (NC)	50 g
330-020-180	DW-AD-501-P12-625	NPN	PUR, 2 m, 3 wire	-	Normally open (NO)	51 g
330-020-181	DW-AD-501-P12-627	NPN	PUR, 2 m, 3 wire	-	Normally open (NO)	65 g
330-020-182	DW-AD-501-P12-639	NPN	PUR, 2 m, 3 wire	-	Normally open (NO)	50 g
330-020-183	DW-AD-502-P12-625	NPN	PUR, 2 m, 3 wire	-	Normally close (NC)	51 g
330-020-184	DW-AD-502-P12-627	NPN	PUR, 2 m, 3 wire	-	Normally close (NC)	65 g
330-020-185	DW-AD-502-P12-639	NPN	PUR, 2 m, 3 wire	-	Normally close (NC)	50 g
330-020-194	DW-AS-503-P12	PNP	M12 4-pin	-	Normally open (NO) / IO-Link	31 g
330-020-195	DW-AS-503-P12-621	PNP	M12 4-pin	-	Normally open (NO) / IO-Link	42 g
330-020-196	DW-AS-503-P12-622	PNP	M12 4-pin	-	Normally open (NO) / IO-Link	50 g
330-020-197	DW-AS-503-P12-624	PNP	M12 4-pin	-	Normally open (NO) / IO-Link	27 g
330-020-198	DW-AS-503-P12-627	PNP	M12 4-pin	-	Normally open (NO) / IO-Link	35 g
330-020-199	DW-AS-503-P12-630	PNP	M12 4-pin	-	Normally open (NO) / IO-Link	27 g
330-020-200	DW-AS-503-P12-635	PNP	M12 4-pin	-	Normally open (NO) / IO-Link	42 g
330-020-201	DW-AS-504-P12	PNP	M12 4-pin	Normally close (NC)	-	31 g
330-020-202	DW-AS-504-P12-621	PNP	M12 4-pin	Normally close (NC)	-	42 g
330-020-203	DW-AS-504-P12-622	PNP	M12 4-pin	Normally close (NC)	-	50 g
330-020-204	DW-AS-504-P12-624	PNP	M12 4-pin	Normally close (NC)	-	27 g
330-020-205	DW-AS-504-P12-627	PNP	M12 4-pin	Normally close (NC)	-	35 g
330-020-206	DW-AS-504-P12-630	PNP	M12 4-pin	Normally close (NC)	-	27 g
330-020-207	DW-AS-504-P12-635	PNP	M12 4-pin	Normally close (NC)	-	42 g
330-020-229	DW-AS-501-P12	NPN	M12 4-pin	-	Normally open (NO)	31 g
330-020-230	DW-AS-501-P12-621	NPN	M12 4-pin	-	Normally open (NO)	42 g
330-020-231	DW-AS-501-P12-622	NPN	M12 4-pin	-	Normally open (NO)	50 g
330-020-232	DW-AS-501-P12-624	NPN	M12 4-pin	-	Normally open (NO)	27 g
330-020-233	DW-AS-501-P12-627	NPN	M12 4-pin	-	Normally open (NO)	35 g
330-020-234	DW-AS-501-P12-630	NPN	M12 4-pin	-	Normally open (NO)	27 g
330-020-235	DW-AS-501-P12-635	NPN	M12 4-pin	-	Normally open (NO)	42 g
330-020-236	DW-AS-502-P12	NPN	M12 4-pin	Normally close (NC)	-	31 g
330-020-237	DW-AS-502-P12-621	NPN	M12 4-pin	Normally close (NC)	-	42 g
330-020-238	DW-AS-502-P12-622	NPN	M12 4-pin	Normally close (NC)	-	50 g
330-020-239	DW-AS-502-P12-624	NPN	M12 4-pin	Normally close (NC)	-	27 g
330-020-240	DW-AS-502-P12-627	NPN	M12 4-pin	Normally close (NC)	-	35 g
330-020-241	DW-AS-502-P12-630	NPN	M12 4-pin	Normally close (NC)	-	27 g
330-020-242	DW-AS-502-P12-635	NPN	M12 4-pin	Normally close (NC)	-	42 g

Note: part reference may include additional suffix to indicate a revision version or special version. Further information is available on request.

Operators of the products we supply are responsible for compliance with measures for the protection of persons. The use of our equipment in applications where the safety of persons might be at risk is only authorized if the operator observes and implements separate, appropriate and necessary measures for the protection of persons and machines. Terms of delivery and rights to change design reserved.