

ON/OFF

DESCRIPTION OF BUTTONS

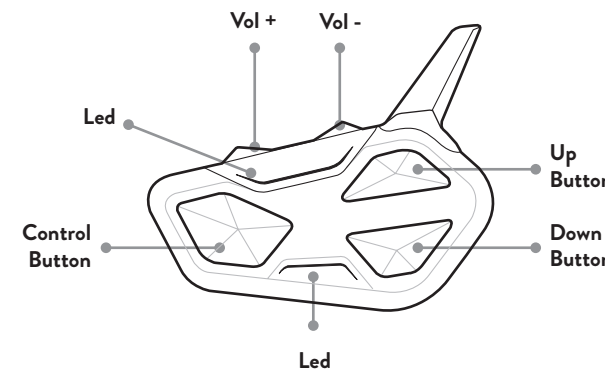

SWITCH ON

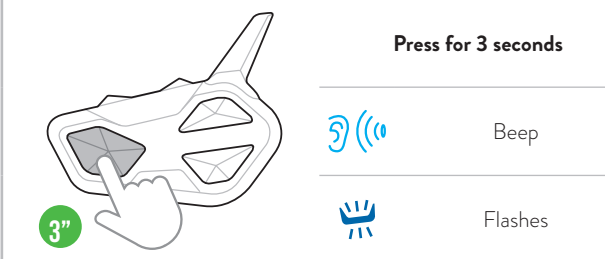

SWITCH OFF

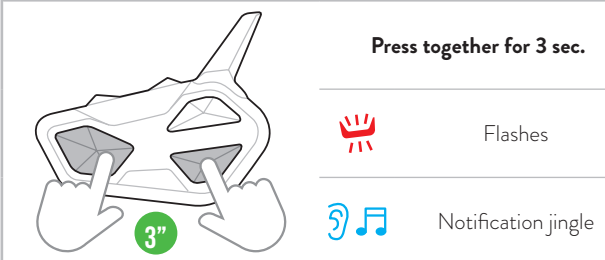

PAIRINGS

DESCRIPTION OF BUTTONS

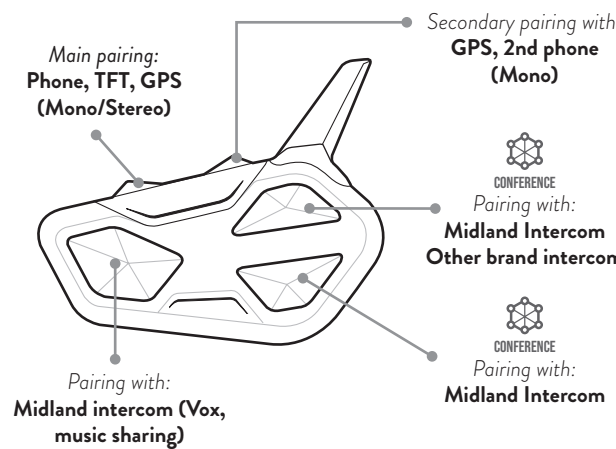

ATTENTION: To carry out any pairings you need to access Settings. If the Control button is pressed for fewer than 7 seconds, the device will switch itself on instead of accessing Settings. If this occurs, repeat the process.

ACCESS SETTINGS

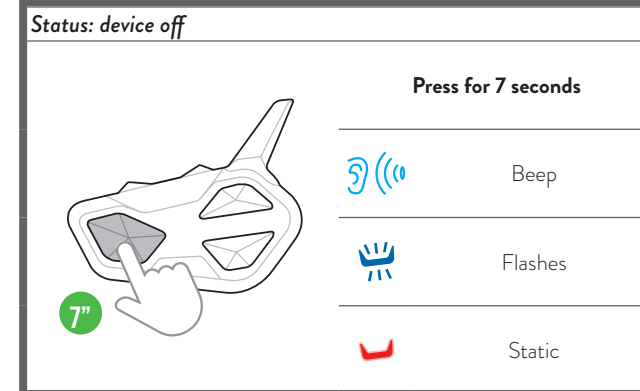

PHONE, GPS, TFT PAIRING

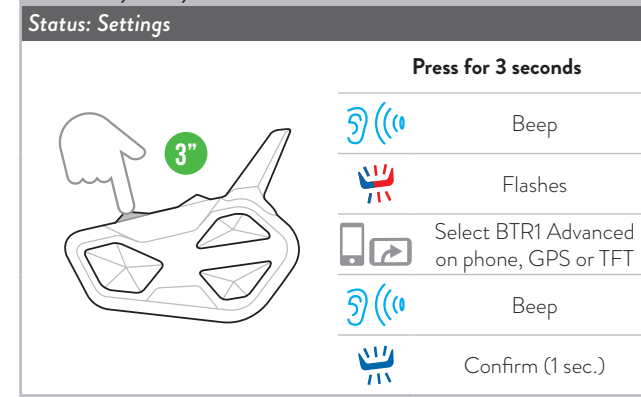

Note: to pair a 2nd device in mono audio, repeat this procedure using Vol -.

MIDLAND INTERCOM PAIRING

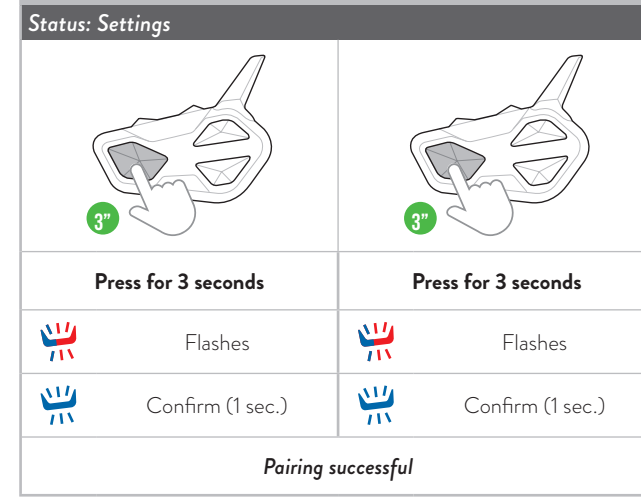

Note: to pair another Midland intercom, follow the same procedure using the Up/Down buttons.

OTHER BRAND INTERCOM PAIRING (UNIVERSAL INTERCOM)

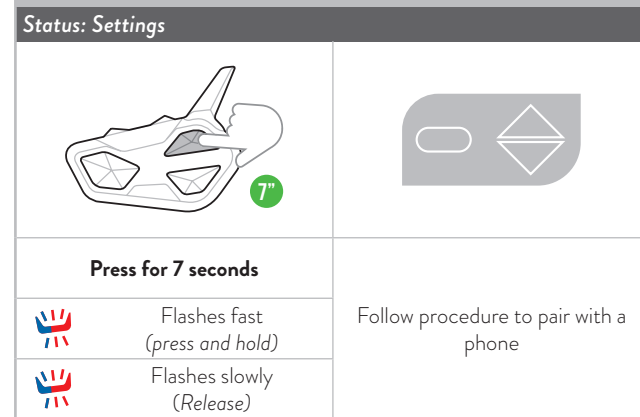

PAIRING 4 UNITS IN CONFERENCE

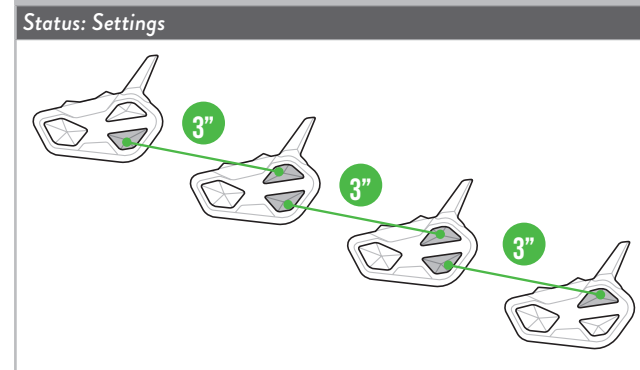

Note: the Conference mode allows the simultaneous communication amongst units. All units must be paired in a "chain" configuration: the Down button of the first unit must be paired to the Up button of the second unit and so on. For a detailed description of the function go to paragraph "Conference" of the complete user manual or watch the video tutorial

RESET BLUETOOTH PAIRINGS

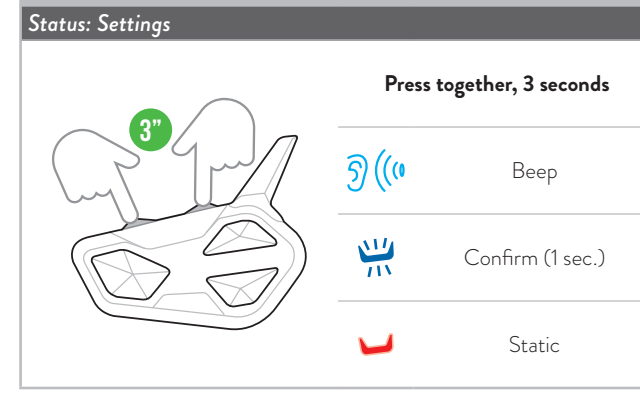

EXIT SETTINGS MODE CANCEL PAIRING

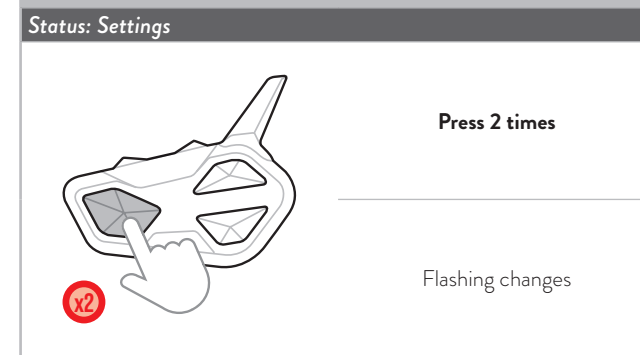

Frequency (GHz)	Max power (mW)
2.402 - 2.480	100

Go to our website midlandeurope.com, download the complete manual and the BT Updater software.

Customize your intercom and discover all the functions with the **BTPRO SetApp**.
Download it here:

POCKET GUIDE

BTR1 ADVANCED

Bike to Bike Conference Communication



HIGH DEFINITION SOUND BY **RCF**



ENGLISH

OPERATING MODES

- A. **Intercom Mode:** to communicate with another device.
- B. **Phone Mode:** for phone calls or for managing music.
- C. **FM Radio Mode:** to listen to radio, search and store stations.

Note: Phone mode and Intercom mode are enabled only when your intercom is paired to other devices.

CHOOSE OPERATING MODE

Status: device on

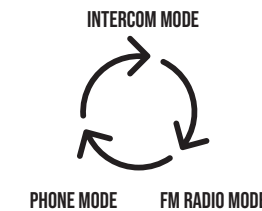

Press for 3 seconds to change mode or press and hold to scroll quickly

Operating mode status

Note: By pressing simultaneously Vol + and Vol -, BTR1 Advanced communicates the selected operating mode.

INTERCOM MODE

FUNCTION DESCRIPTION

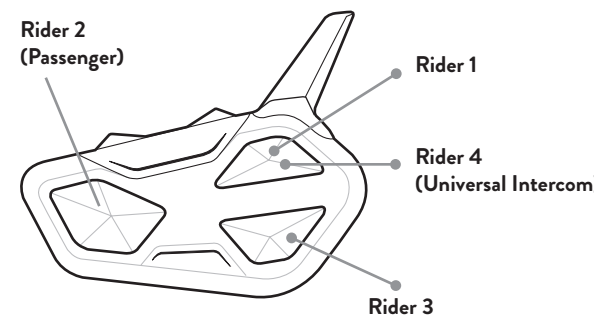

TO OPEN/CLOSE INTERCOM MANUALLY

Status: Intercom mode



Note: to communicate with Rider 1/3 repeat the process pressing the Up/ (Rider 1)/Down (Rider 3) buttons.

VOX ACTIVATION/DEACTIVATION

Status: in all modes



TO OPEN/CLOSE INTERCOM BY VOICE

Status: in all modes

- Say "Hi"
- Voice announcement
- Flashes
- Silent for 40 sec. **the intercom deactivates**
- Beep

Note: Voice activation is only possible when the intercom device is paired with the **Control** button.

SHORTCUT: In Intercom/FM radio modes pressing Control 2 times activates/deactivates the music.

TO OPEN/CLOSE UNIVERSAL INTERCOM

Status: Intercom mode

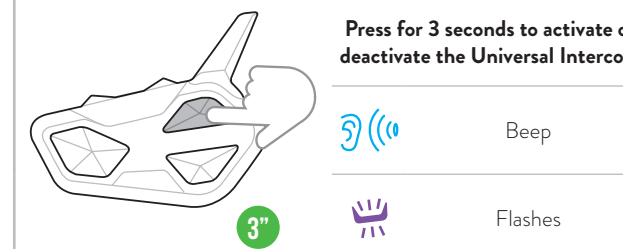

Note: to activate/deactivate the audio from a different brand device, use the voice call command (for some models it is necessary to send the voice call twice)

TO ENABLE/DISABLE THE CONFERENCE MODE

Status: in all modes

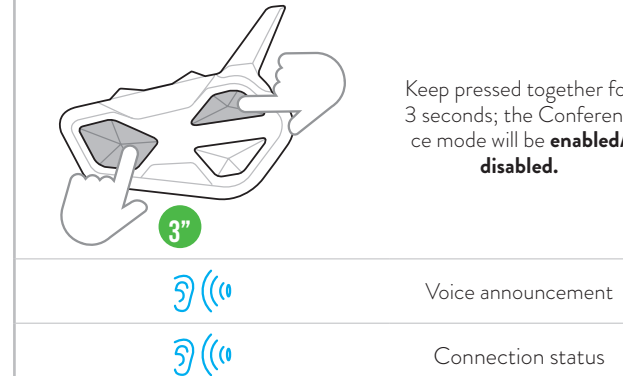

Note: in Conference mode, the devices paired to Vol+/Vol- are temporarily disconnected.

TO OPEN/CLOSE CONFERENCE

Status: Conference mode

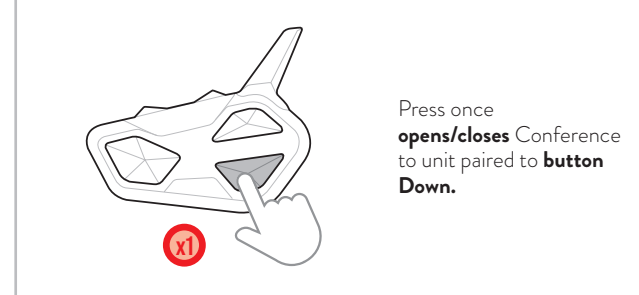
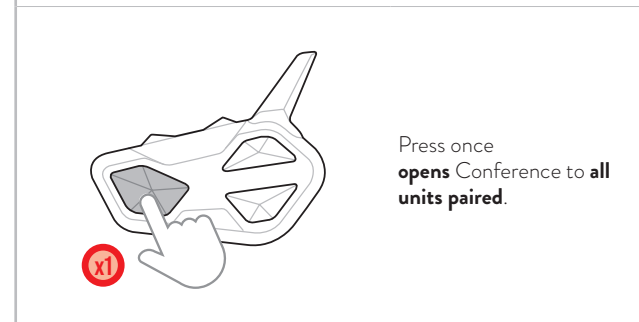

PHONE MODE

FUNCTION DESCRIPTION

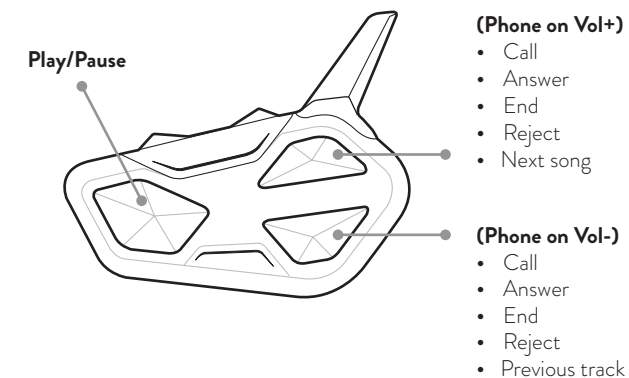

MAKING A CALL

Status: Phone mode



Note: If you have a phone paired with the Vol - button, use the Down button.

SHORTCUT: In Phone mode by pressing the UP/DOWN buttons twice, turns the Intercom on/off (Rider 1, 3).

ANSWERING/ENDING A CALL - REJECTING A CALL

Status: All modes

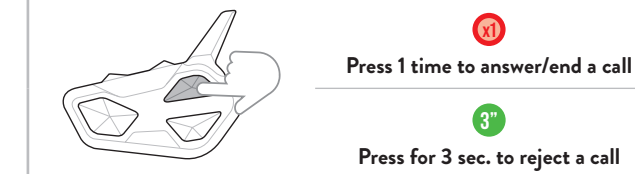

Note: If you have a phone paired with the Vol - button, use the Down button.

MUSIC

Status: Phone mode

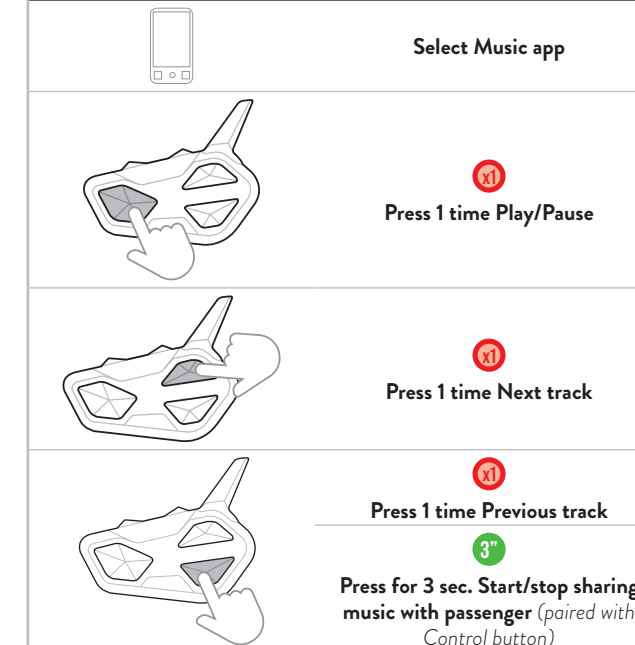

RADIO MODE

FUNCTION DESCRIPTION

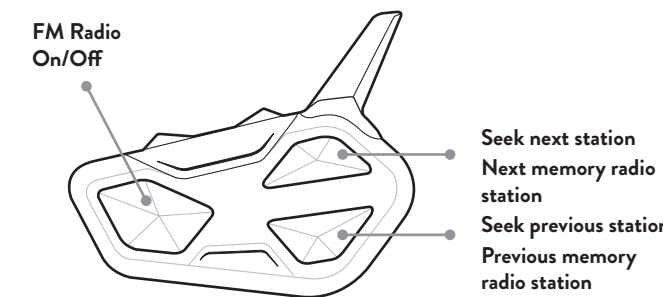

FM RADIO

Status: Radio mode

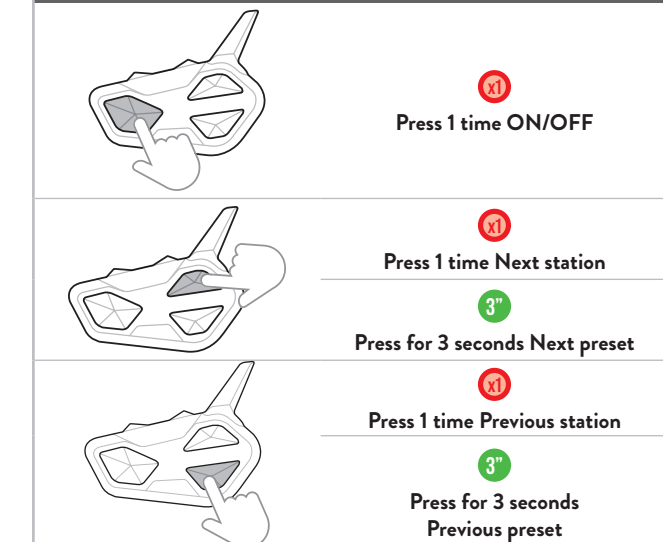

ON/OFF

DESCRIZIONE TASTI

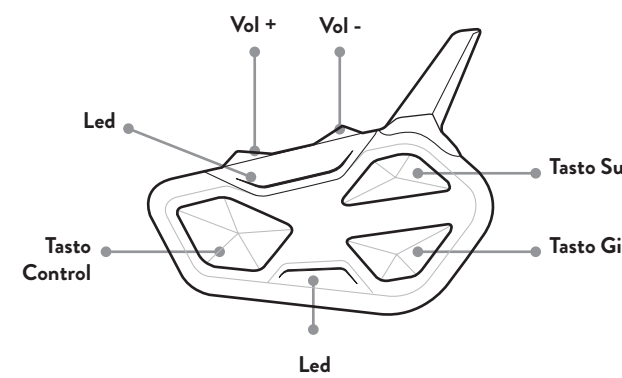

ACCENSIONE

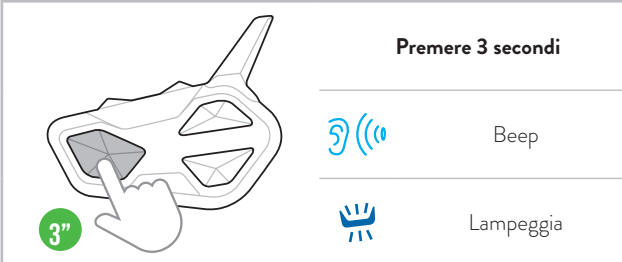

SPEGNIMENTO

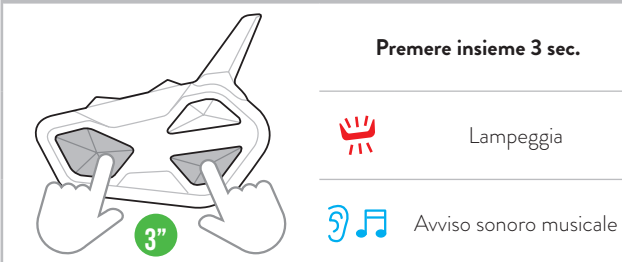

ABBINAMENTI

DESCRIZIONE TASTI

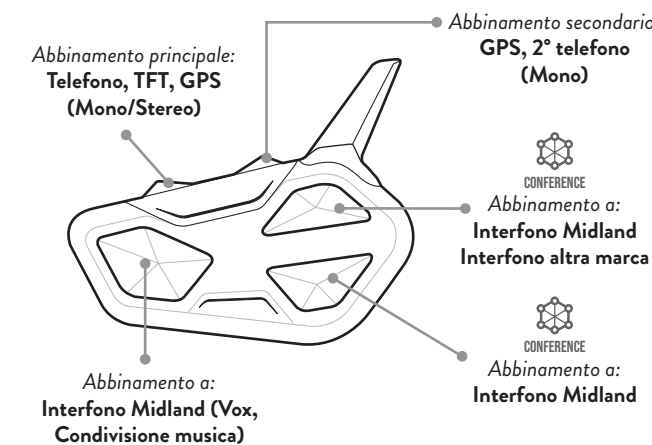

ATTENZIONE: Per effettuare qualsiasi abbinamento è necessario entrare in Impostazioni. Se premete il tasto Control meno di 7 secondi, il dispositivo si accenderà anziché entrare in Impostazioni. In tal caso ripetere l'operazione.

ENTRARE IN IMPOSTAZIONI

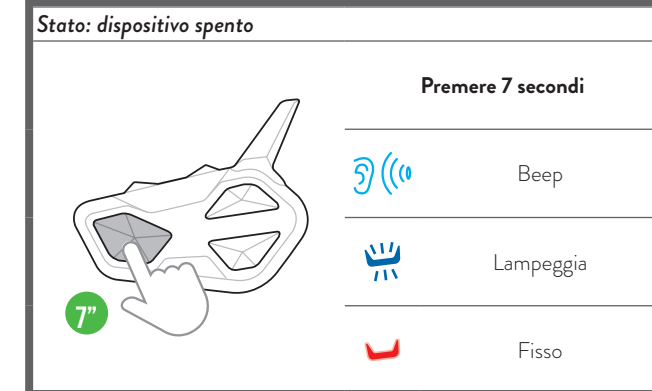

ABBINAMENTO TELEFONO, GPS, TFT



Nota: per abbinare un 2° dispositivo in audio mono, ripetere questa procedura utilizzando Vol -.

ABBINAMENTO INTERFONO MIDLAND

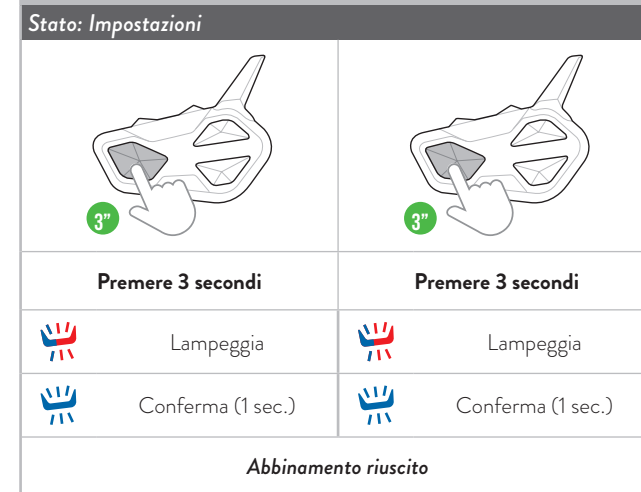

Nota: per abbinare un altro interfono Midland, seguire la stessa procedura utilizzando i tasti Su/Giù.

ABBINAMENTO INTERFONO ALTRA MARCA (UNIVERSAL INTERCOM)



Seguire la procedura di abbinamento al telefono

RESET ABBINAMENTI BLUETOOTH



USCIRE DALLA MODALITÀ IMPOSTAZIONI

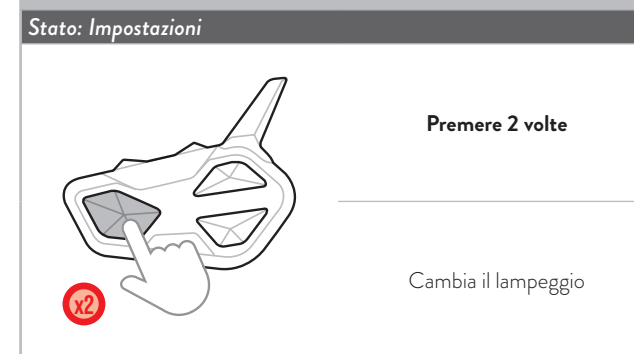

ABBINAMENTO A 4 INTERFONI IN CONFERENCE

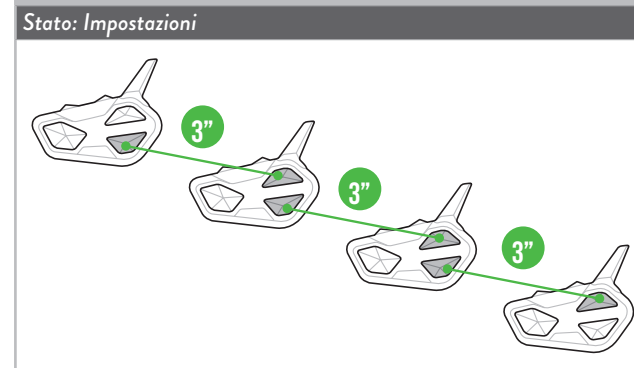

Nota: La modalità Conference permette la comunicazione contemporanea di più dispositivi. È necessario abbinare i dispositivi a "catena", ovvero il pulsante "Giù" del primo dispositivo deve essere abbinato al pulsante "Su" del secondo, e così via. Per maggiori dettagli consultate il paragrafo "Conference" sul manuale d'uso o il Video Tutorial.

Frequenza (GHz)	Potenza max (mW)
2.402 - 2.480	100

Vai sul sito midlandeurope.com, scarica il manuale completo e il software BT Updater.

Personalizza il tuo interfono e scopri tutte le funzioni con **BTPRO SetApp**. Scaricala qui:

POCKET GUIDE

BTR1 ADVANCED

Bike to Bike Conference Communication



HIGH DEFINITION SOUND BY **RCF**



ITALIANO

MODALITÀ OPERATIVE

- A. **Modalità Intercom:** per comunicare con un altro dispositivo.
 B. **Modalità telefono:** per chiamate telefoniche o per gestire la musica.
 C. **Modalità radio FM:** per ascoltare, cercare e memorizzare stazioni radio.

Nota: Le modalità Intercom e Telefono sono attive solo quando ci sono dei dispositivi abbinati.

SELEZIONARE LA MODALITÀ OPERATIVA

Stato: dispositivo acceso

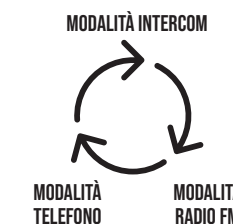

Premere 3 secondi per cambiare modalità o tenere premuto per scorrerle velocemente

Stato modalità operativa

Nota: Premendo contemporaneamente Vol + e Vol -, BTR1 Advanced comunica la modalità operativa selezionata.

MODALITÀ INTERCOM

DESCRIZIONE FUNZIONI

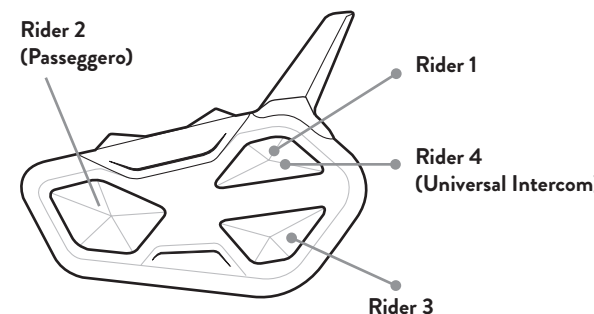

APRIRE/CHIUDERE INTERCOM MANUALMENTE

Stato: modalità Intercom



Nota: per comunicare con Rider 1/3 ripetere l'operazione premendo il tasto Su (Rider 1)/Giù (Rider 3).

ATTIVARE/DISATTIVARE IL VOX

Stato: in tutte le modalità

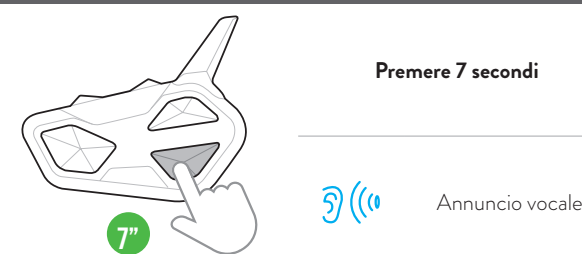

APRIRE/CHIUDERE L'INTERCOM VOCALMENTE

Stato: in tutte le modalità

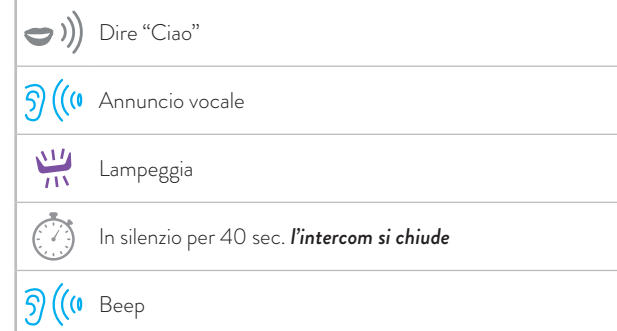

Nota: l'attivazione vocale è possibile solo con un interfono abbinato al tasto Control.

SHORTCUT: In modalità Intercom/FM Radio premendo 2 volte Control attivi/disattivi la musica.

APRIRE/CHIUDERE UNIVERSAL INTERCOM

Stato: modalità Intercom



Nota: per aprire/chiudere l'audio dal dispositivo di altra marca, utilizzare il comando di chiamata vocale (per alcuni modelli è necessario inviare la chiamata vocale 2 volte)

ATTIVARE/DISATTIVARE CONFERENCE

Stato: in tutte le modalità

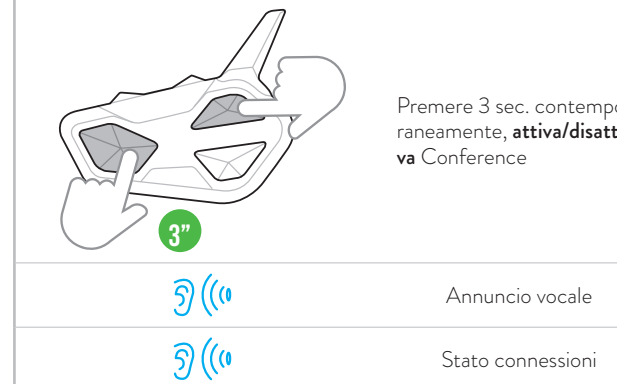

Nota: Durante la Conference, i dispositivi abbinati a Vol+/Vol- sono momentaneamente scollegati.

APRIRE/CHIUDERE CONFERENCE

Stato: Conference

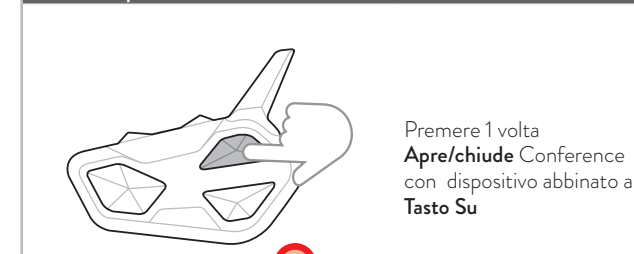

Nota: Premere 1 volta Apre/chiude Conference con dispositivo abbinato al Tasto Su

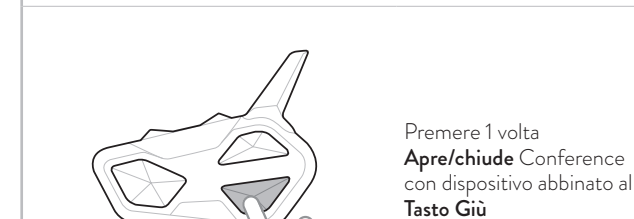
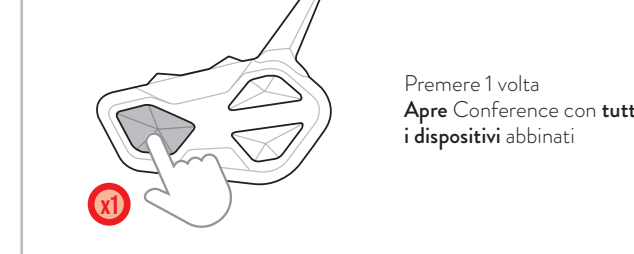

Nota: Premere 1 volta Apre/chiude Conference con dispositivo abbinato al Tasto Giù

MODALITÀ TELEFONO

DESCRIZIONE FUNZIONI

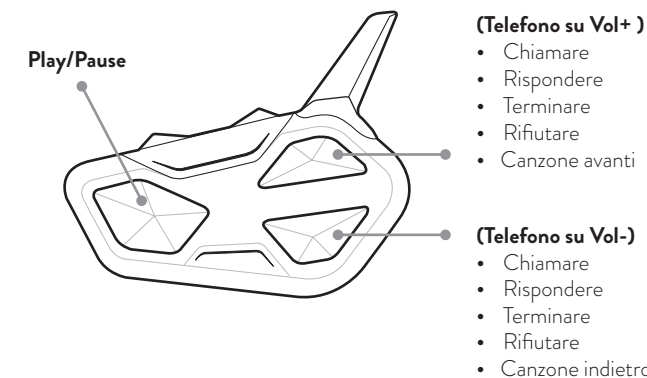

EFFETTUARE UNA CHIAMATA

Stato: modalità Telefono

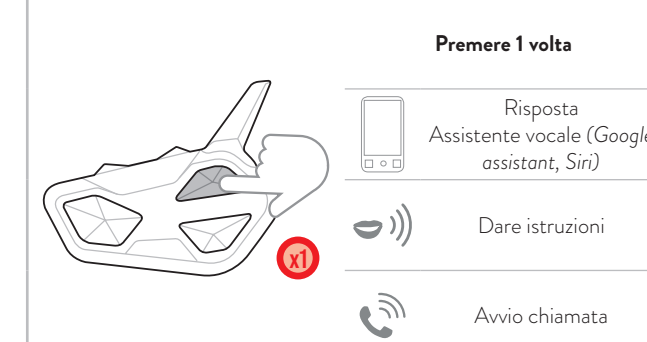

Nota: se avete un telefono abbinato al tasto Vol -, utilizzate il tasto Giù.

SHORTCUT: Nelle modalità Telefono premendo 2 volte Up/Down, apri/chiudi l'Intercom (Rider 1, 3).

RISPONDERE/TERMINARE UNA CHIAMATA RIFIUTARE UNA CHIAMATA

Stato: in tutte le modalità

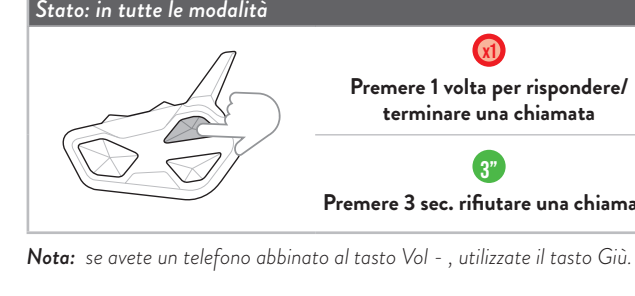

Nota: se avete un telefono abbinato al tasto Vol -, utilizzate il tasto Giù.

MUSICA

Stato: modalità Telefono



MODALITÀ RADIO

DESCRIZIONE FUNZIONI

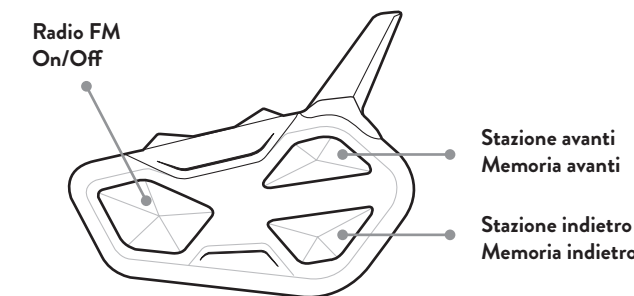

RADIO FM

Stato: modalità Radio

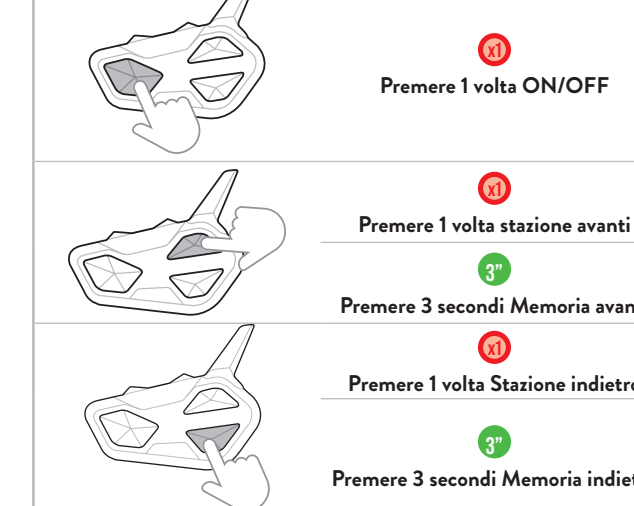

EIN-/AUSSCHALTEN

TASTENBESCHREIBUNG

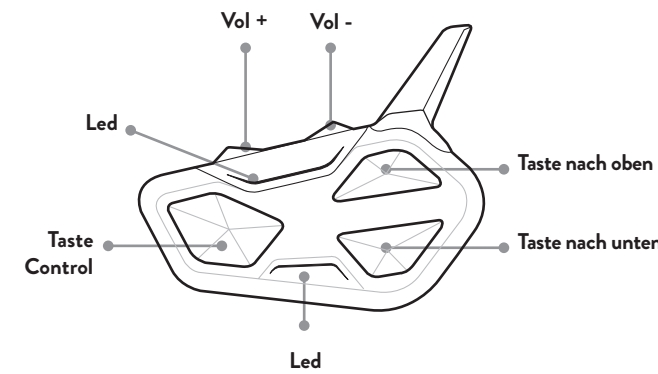

EINSCHALTEN

	3 Sekunden drücken
	Pfeifton
	Blinkt

AUSSCHALTEN

	3 Sekunden zusammen drücken
	Blinkt
	Musikalischer Benachrichtigungston

VERBINDUNGEN

TASTENBESCHREIBUNG

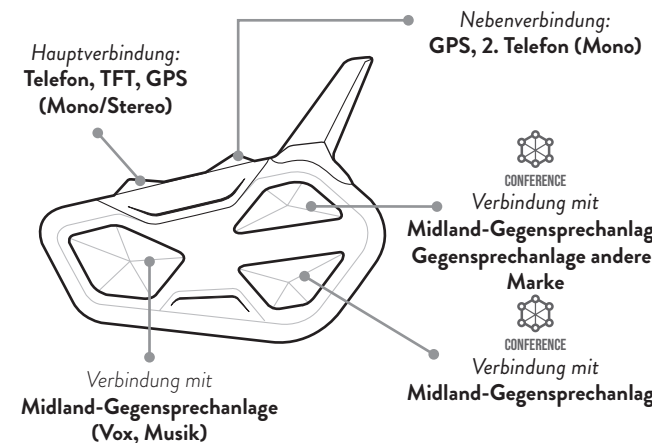

ACHTUNG: Zur Herstellung jeglicher Verbindungen, ist das Öffnen der Einstellungen erforderlich. Wenn Sie die Taste Control weniger als 7 Sekunden drücken, schaltet sich das Gerät ein, anstatt die Einstellungen zu öffnen. In diesem Fall den Vorgang wiederholen.

EINSTELLUNGEN ÖFFNEN

	7 Sekunden drücken
	Pfeifton
	Blinkt
	Durchgehend

VERBINDUNG MIT TELEFON, GPS, TFT

Status: Einstellungen	
	3 Sekunden drücken
	Pfeifton
	Blinkt
	BTR1 Ad. auf Telefon, GPS oder TFT auswählen
	Pfeifton
	Bestätigung (1 Sek.)

Hinweis: Zum Verbinden eines zweiten Geräts in Mono-Audio diesen Vorgang mit **Vol** - wiederholen.

VERBINDUNG MIT MIDLAND-GEGENSPRECHANLAGE

Status: Einstellungen	
	3 Sekunden drücken
	Blinkt
	Bestätigung (1 Sek.)
	3 Sekunden drücken
	Blinkt
	Bestätigung (1 Sek.)
Verbindung hergestellt	

Hinweis: Um eine weitere Midland Gegensprechanlage zu verbinden, den gleichen Vorgang mit der **Taste nach oben** (Rider 1)/nach unten (Rider 3) ausführen.

VERBINDUNG MIT GEGENSPRECHANLAGE ANDERER MARKE (UNIVERSAL INTERCOM)

Status: Einstellungen	
	7 Sekunden drücken
	Blinkt schnell (gedrückt halten)
	Blinkt langsam (loslassen)
	Den Vorgang zur Verbindung mit dem Telefon befolgen

RESET DER BLUETOOTH-VERBINDUNGEN

Status: Einstellungen	
Zusammen drücken, 3 Sekunden	
	3 Sekunden drücken
	Pfeifton
	Bestätigung (1 Sek.)
	Durchgehend

DEN MODUS EINSTELLUNGEN VERLASSEN VERBINDUNG UNTERBRECHEN

Status: Einstellungen	
2 Mal drücken	
	2 Mal drücken
Das Blinken ändert sich	

4 GERÄTE IN KONFERENZ VERBINDEN

Status: Einstellungen	

Hinweis: der Konferenzmodus erlaubt die gleichzeitige Kommunikation aller Geräte. Die Geräte werden als "Kette" verbunden: die Unten-Taste des 1. Gerätes muss mit der Oben-Taste des 2. Gerätes usw. gekoppelt sein. Für eine ausführliche Beschreibung schauen Sie in der Gesamtanleitung im Kapitel "Konferenz" oder im Tutorial-Video nach.

Frequenz (GHz)	Max Leistung (mW)
2,402 - 2,480	100

Besuchen Sie die Website midland.de zum Herunterladen des vollständigen Handbuchs und der Software **BT Updater**.

Gestalten Sie Ihre Gegensprechanlage mit der **BTPRO SetApp** individuell. Laden Sie sie hier herunter:



KURZANLEITUNG

BTR1 ADVANCED

Bike to Bike Conference Communication



HIGH DEFINITION SOUND BY **RCF**



DEUTSCH

BETRIBSMODI

- A. Intercom-Modus:** Für die Kommunikation mit einem anderen Gerät.
 - B. Telefon-Modus:** Für Telefonanrufe oder zur Steuerung von der Musik.
 - C. UKW-Radio-Modus:** Zum Anhören, Suchen und Speichern von Radiostationen.
- Hinweis: Der Telefon-Modus ist nur aktiv, wenn Ihre Gegensprechanlage mit einem entsprechenden Gerät gekoppelt ist.*

BETRIBSMODUS AUSWÄHLEN

Status: Gerät eingeschaltet

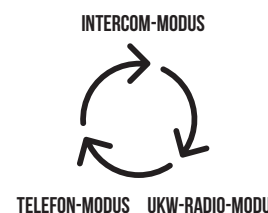

3 Sekunden drücken, um die Betriebsmodi zu ändern oder gedrückt halten, um sie schnell zu durchlaufen

Status Betriebsmodus

Hinweis: Durch gleichzeitiges Drücken von Vol + und Vol - 1 Sekunde lang teilt BTR1 Advanced den ausgewählten Modus mit.

INTERCOM-MODUS

BESCHREIBUNG DER FUNKTIONEN

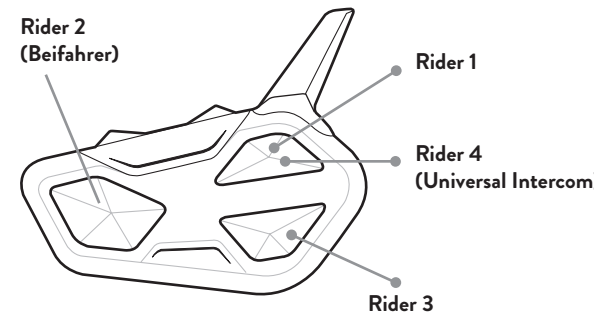

MANUELLES ÖFFNEN/SCHLIESSEN DES INTERCOM

Status: Intercom-Modus



Hinweis: Zum Kommunizieren mit Rider 1/3 den Vorgang wiederholen, indem die Taste nach oben /nah Unten (Rider 3) betätigt wird.

SHORTCUT: Im Intercom-/UKW-Radio-Modus wird die Musik durch 2-maliges Drücken von Control ein-/ausgeschaltet.

AKTIVIERUNG/DEAKTIVIERUNG VON VOX

Status: in allen Modi

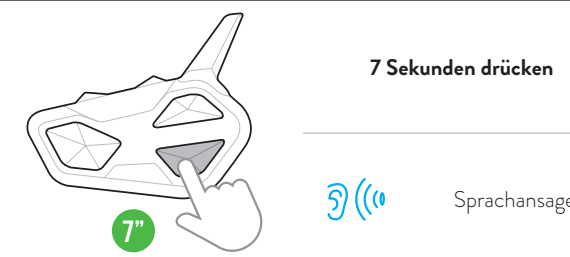

ÖFFNEN/SCHLIESSEN DES INTERCOM DURCH SPRACHSIGNAL

Status: in allen Modi

- „Hallo“ sagen
- Sprachansage
- Blinkt
- Nach 40 Sek. Stille wird die Kommunikation geschlossen
- Pfeifton

Hinweis: Die Sprachaktivierung ist nur mit der Taste Control verbundener Gegensprechanlage möglich.

ÖFFNEN/SCHLIESSEN VON UNIVERSAL INTERCOM

Status: Intercom-Modus



Hinweis: Verwenden Sie den Sprachbefehl, um das Audio von einem Gerät einer anderen Marke zu öffnen/schließen (für einige Modelle ist es notwendig, den Sprachbefehl 2 Mal zu senden)

KONFERENZ AKTIVIEREN/DEAKTIVIEREN

Status: in allen Modi

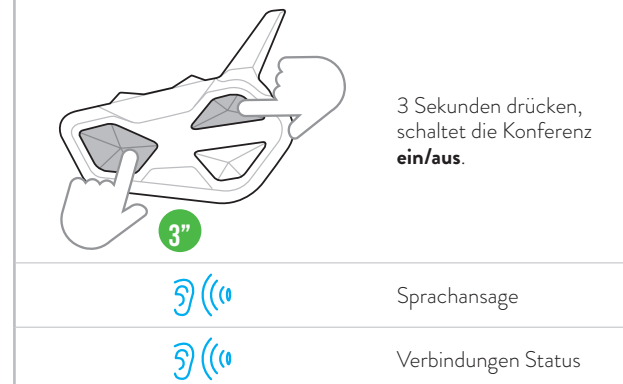

Anmerkung: Die Geräte mit Pairing Vol+/- sind vorübergehend nicht verbunden.

KONFERENZ ÖFFNEN/SCHLIESSEN

Status: Konferenz



Einmal drücken, um die Konferenz zu dem auf **Taste Oben** gekoppelten Gerät zu öffnen/schließen.

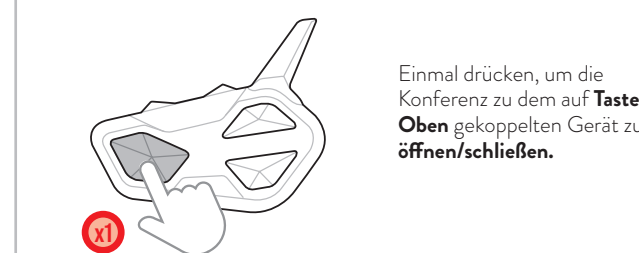

Einmal drücken, um die Konferenz zu dem auf **Taste Unten** gekoppelten Gerät zu öffnen/schließen.

TELEFON-MODUS

BESCHREIBUNG DER FUNKTIONEN

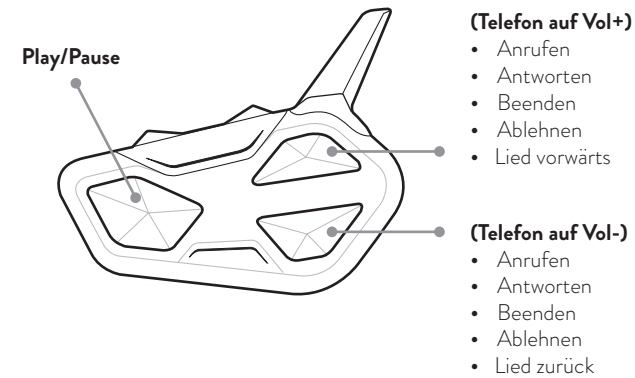

TÄTIGEN EINES ANRUF

Status: Telefon-Modus

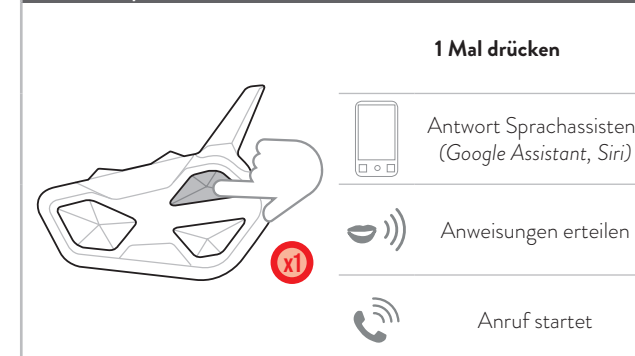

Hinweis: Wenn Sie ein Telefon mit der Taste Vol- verbunden haben, verwenden Sie die Taste nach unten.

SHORTCUT: In dem Telefon-Modus wird das Intercom durch 2-maliges Drücken der Taste Up/Down geöffnet/geschlossen (Rider 1, 3).

ANNEHMEN/BEENDEN EINES ANRUF

Status: in allen Modi

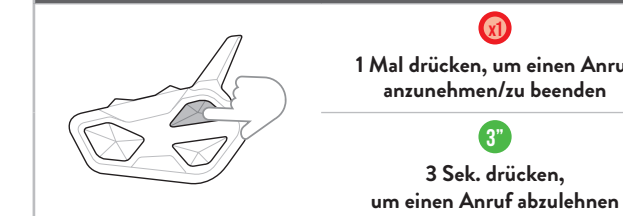

Hinweis: Wenn Sie ein Telefon mit der Taste Vol- verbunden haben, verwenden Sie die Taste nach unten.

MUSIK

Status: Telefon-Modus

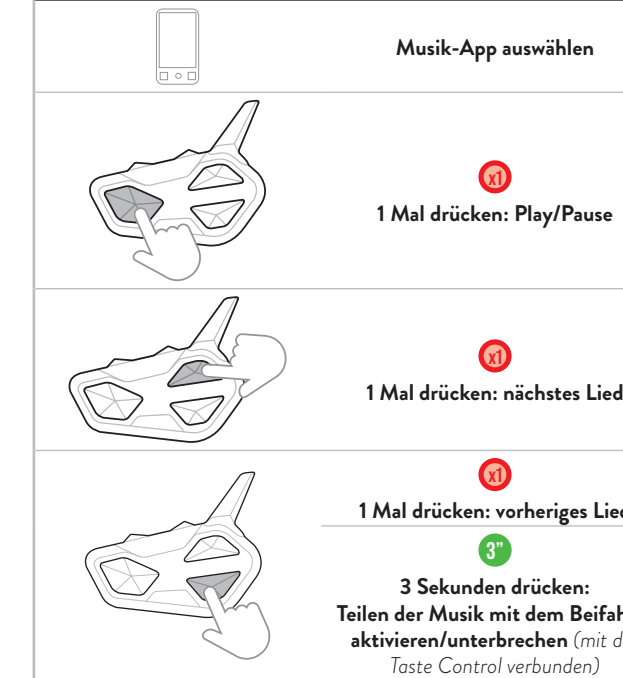

RADIO-MODUS

BESCHREIBUNG DER FUNKTIONEN

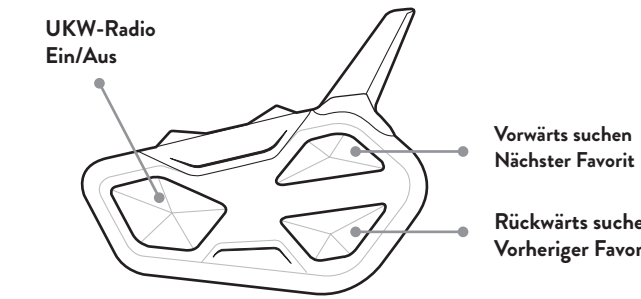

UKW-RADIO

Status: Radio-Modus

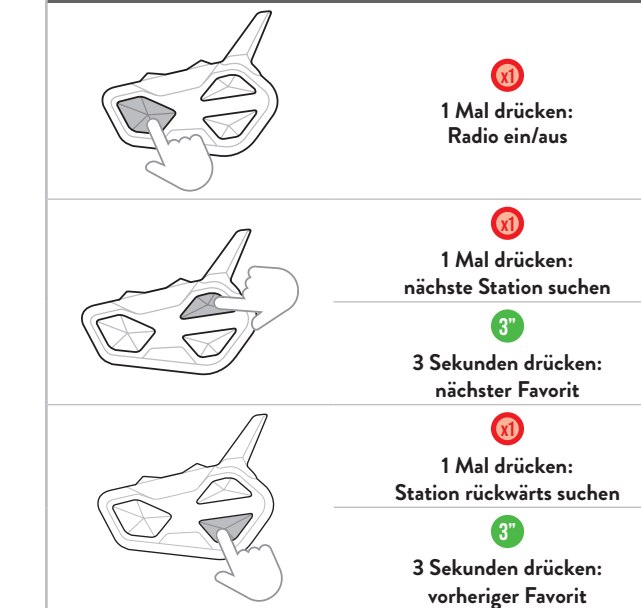

ON/OFF

DESCRIPCIÓN DE LOS BOTONES

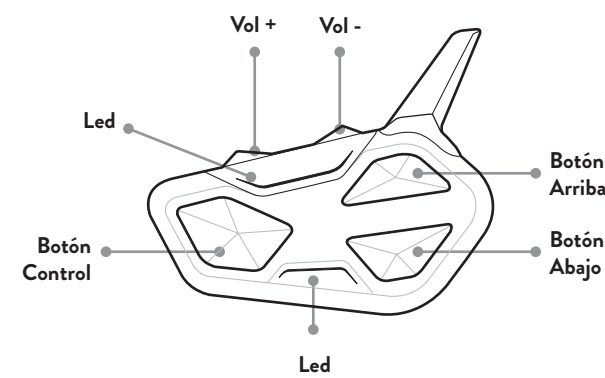

ENCENDIDO



APAGADO

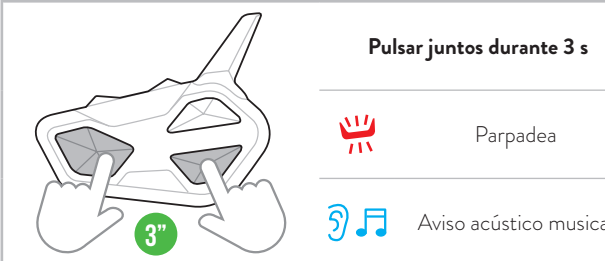

EMPAREJAMIENTO

DESCRIPCIÓN DE LOS BOTONES

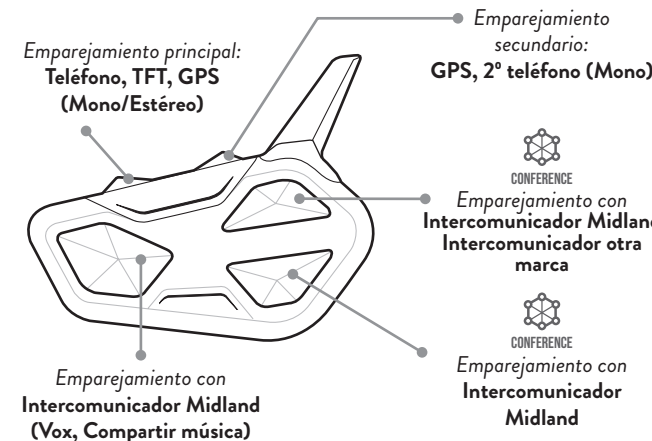

ATENCIÓN: para realizar cualquier tipo de emparejamiento, entrar en Ajustes. Si se pulsa el botón Control durante menos de 7 segundos, el dispositivo se encenderá en lugar de entrar en Ajustes. En este caso, repetir la operación.

ENTRAR EN AJUSTES

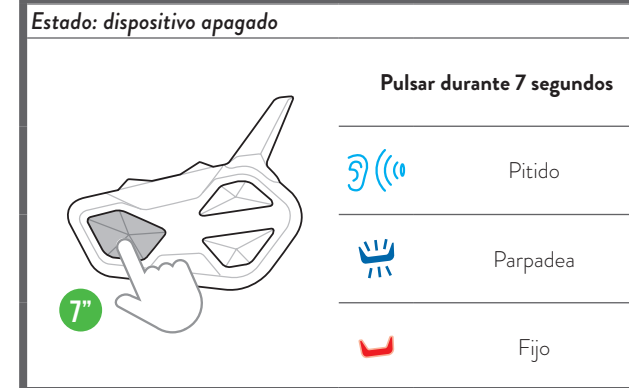

EMPAREJAMIENTO TELÉFONO, GPS, TFT

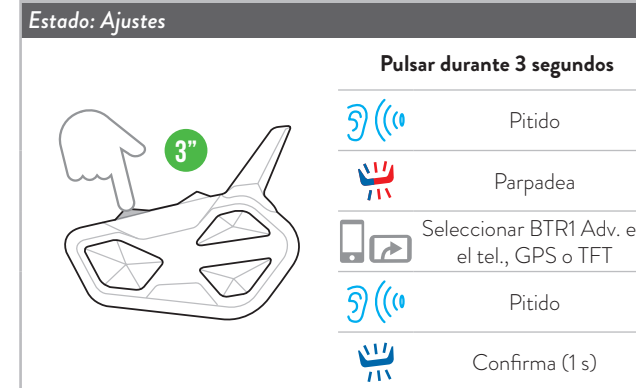

Nota: para emparejar un 2º dispositivo en audio mono, repetir este procedimiento utilizando Vol -.

EMPAREJAMIENTO CON 4 UNIDADES EN CONFERENCIA

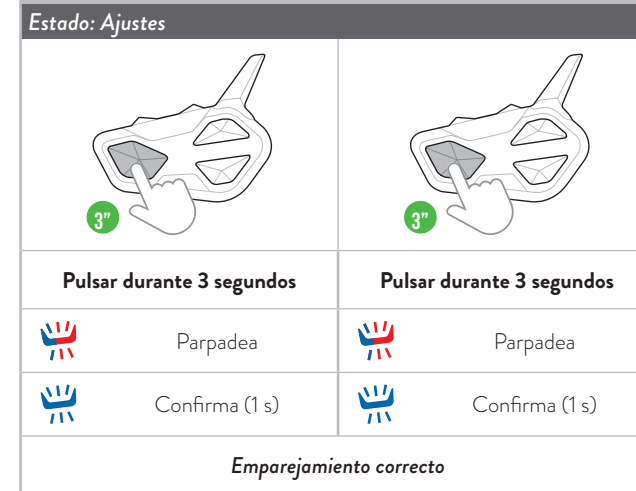

Nota: para emparejar otro intercomunicador Midland, seguir el mismo procedimiento utilizando el botón Arriba/Abajo.

EMPAREJAMIENTO INTERCOMUNICADOR DE OTRA MARCA (UNIVERSAL INTERCOM)

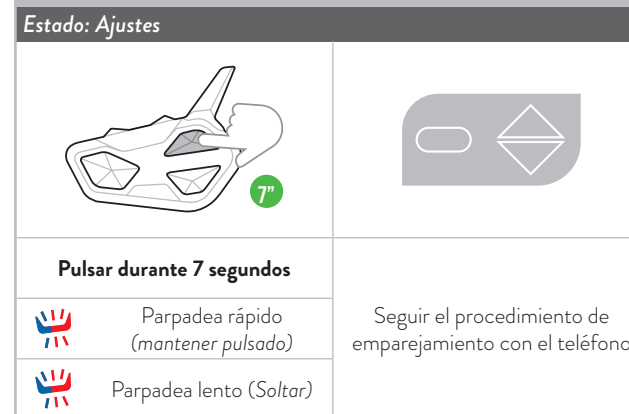

COMBINACIÓN DE 4 INTERFONOS EN CONFERENCIA

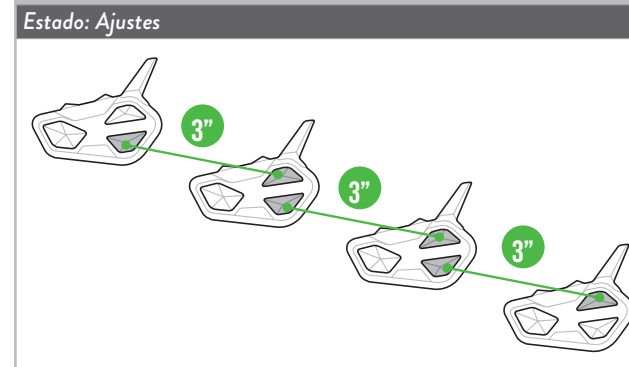

Nota: el modo "Conferencia" permite la comunicación simultánea de varios dispositivos. Para usar dicha función, los dispositivos deben estar enlazados en modo "cadena": enlazar el botón "Abajo" del primer intercomunicador al botón "Arriba" del segundo, y así sucesivamente. Para más información, ver el párrafo "Conferencia" del manual de usuario o el videotutorial.

REINICIAR EMPAREJAMIENTOS BLUETOOTH

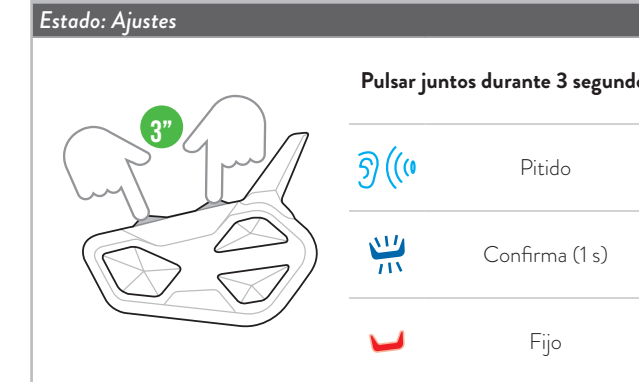

SALIR DEL MODO DE AJUSTES INTERRUPTIR EL EMPAREJAMIENTO

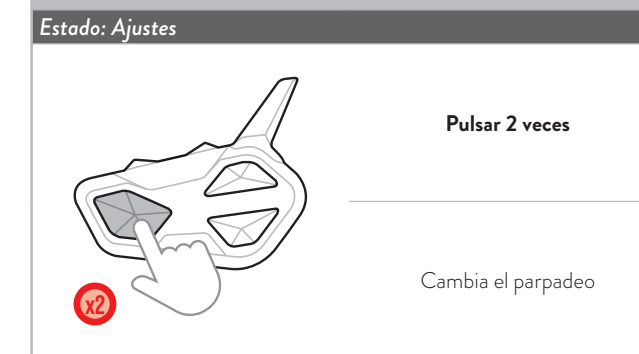

Frecuencia (GHz)	Potencia máx (mW)
2.402 - 2.480	100

Visita el sitio web midlandeurope.com, descarga el manual completo y el software BT Updater.

Personaliza el intercomunicador y descubre todas las funciones con con **BTPRO SetApp**. Descárgala aquí:



BTR1 ADVANCED

Bike to Bike Conference Communication



HIGH DEFINITION SOUND BY **RCF**

MIDLAND

MODOS DE FUNCIONAMIENTO

- A. **Modo Intercom:** para comunicarse con otro dispositivo.
 B. **Modo teléfono:** para llamar por teléfono o para gestionar la música.
 C. **Modo radio FM:** para escuchar, buscar y memorizar las emisoras de radio.

Nota: los modos de intercomunicación y teléfono están activos solo cuando hay dispositivos emparejados con los botones Vol+/Vol-.

SELECCIONAR EL MODO DE FUNCIONAMIENTO

Estado: dispositivo encendido

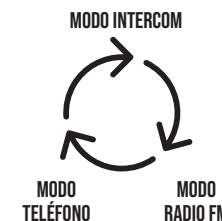

Pulsar durante 3 segundos para cambiar el modo o mantener pulsado para pasarlos rápidamente

Estado modo de funcionamiento

Nota: al pulsar simultáneamente Vol + y Vol - durante 1 segundo, BTR1 Advanced comunica el modo de funcionamiento seleccionado.

MODO INTERCOM

DESCRIPCIÓN DE LAS FUNCIONES

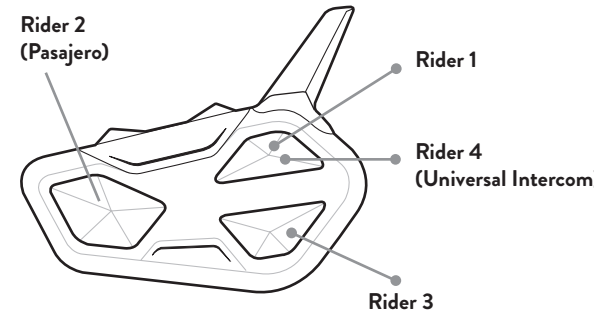

ABRIR/CERRAR EL INTERCOMUNICADOR MANUALMENTE

Estado: modo Intercom



Nota: para comunicarse con Rider 1/3, repetir la operación pulsando el botón Arriba (rider 1)/Abajo rider 3).

ACTIVAR/DESACTIVAR EL VOX

Estado: en todos los modos

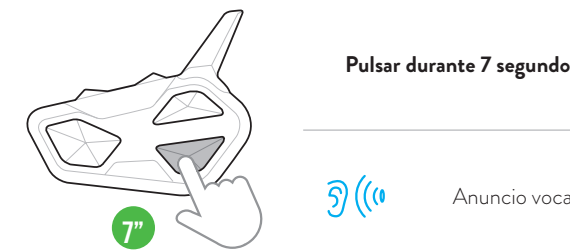

ABRIR/CERRAR EL INTERCOMUNICADOR CON LA VOZ

Estado: en todos los modos

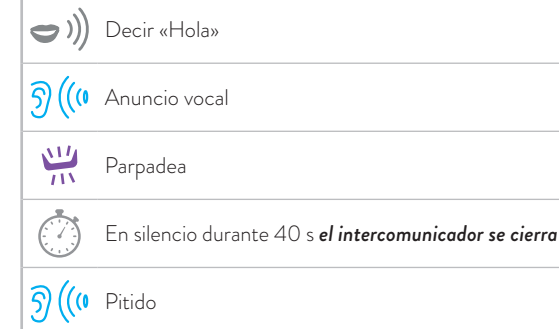

Nota: la activación con la voz se puede realizar con un intercomunicador emparejado con el botón Control.

ATAJO: Play/Pausa de la música en modo Intercom/Radio FM: pulsar 2 veces la tecla Control.

ABRIR/CERRAR UNIVERSAL INTERCOM

Estado: modo Intercom



Nota: para abrir/cerrar el audio desde el dispositivo de otra marca, utilizar el comando de llamada de voz (en algunos modelos es necesario enviar 2 veces la llamada de voz)

ACTIVAR/DESACTIVAR CONFERENCIA

Estados: en todos los modos



Nota: los dispositivos emparejados en Vol+/- se desconectan temporalmente

ABRIR/CERRAR CONFERENCIA

Estado: Conferencia



MODO TELÉFONO

DESCRIPCIÓN DE LAS FUNCIONES

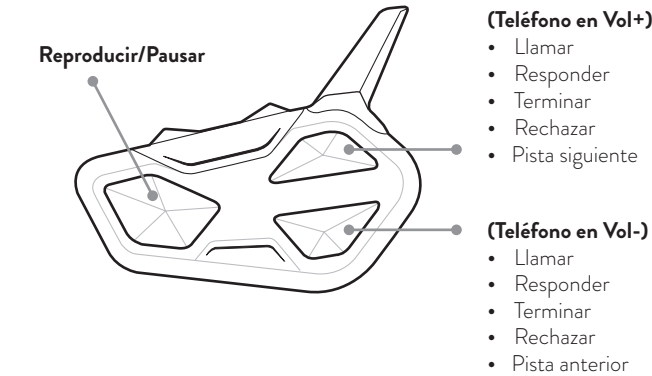

REALIZAR UNA LLAMADA

Estado: modo Teléfono



Nota: si el teléfono está emparejado con el botón Vol -, utilizar el botón Abajo.

ATAJO: en el modo Teléfono, pulsando 2 veces el botón Up/Down, se abre/cierra el Intercomunicador (Rider 1, 3).

RESPONDER/TERMINAR UNA LLAMADA RECHAZAR UNA LLAMADA

Estado: en todos los modos

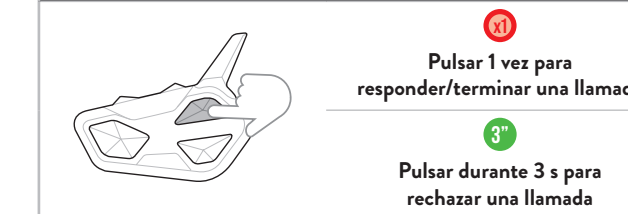

Nota: si el teléfono está emparejado con el botón Vol -, utilizar el botón Abajo.

MÚSICA

Estado: modo Teléfono

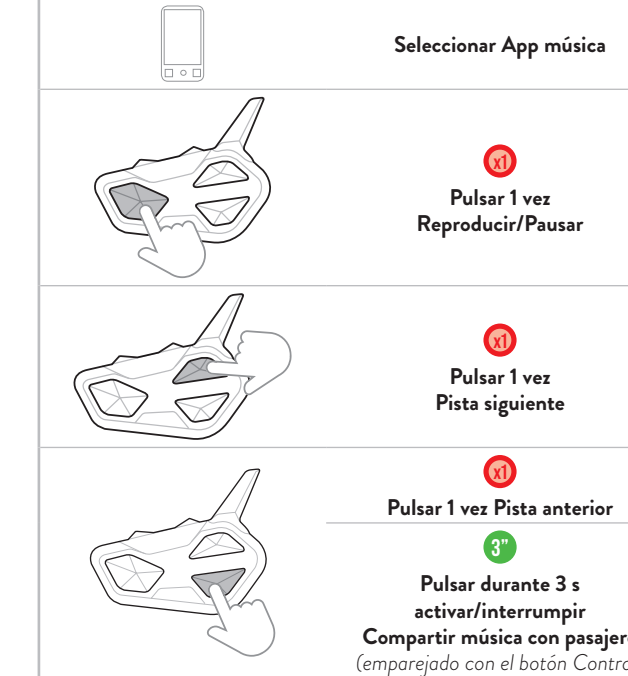

MODO RADIO

DESCRIPCIÓN DE LAS FUNCIONES

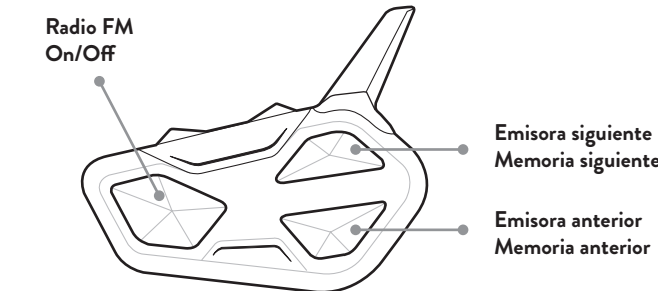

RADIO FM

Estado: modo Radio



ON/OFF

DESCRIPTION DES TOUCHES

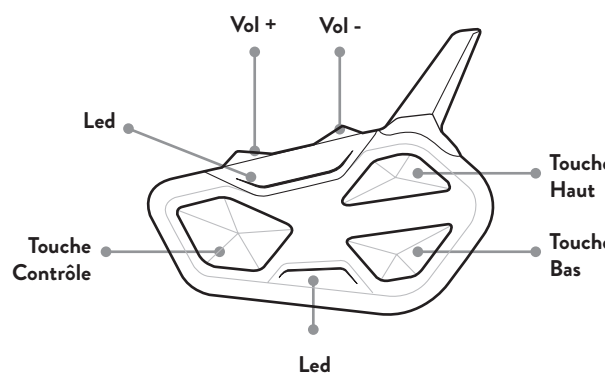

POUR ALLUMER

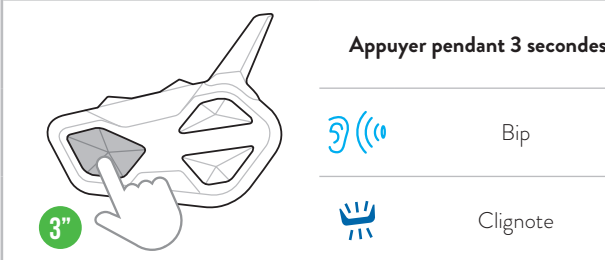

POUR ÉTEINDRE

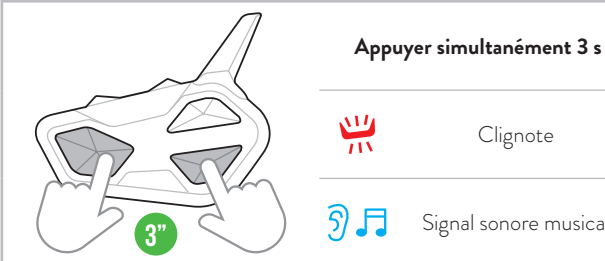

APPAIRAGES

DESCRIPTION DES TOUCHES

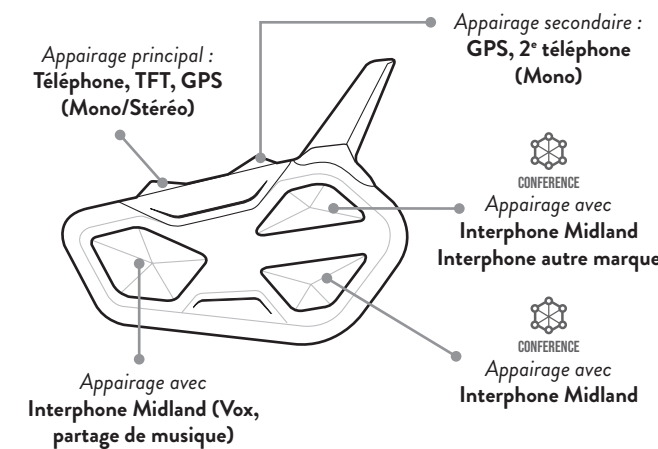

ATTENTION : Pour effectuer n'importe quel appairage il faut entrer dans Configurations. Si l'on appuie sur la touche Contrôle pendant moins de 7 secondes, l'appareil s'allume au lieu d'entrer dans Configurations. Dans ce cas, répéter l'opération.

ENTRER DANS CONFIGURATIONS

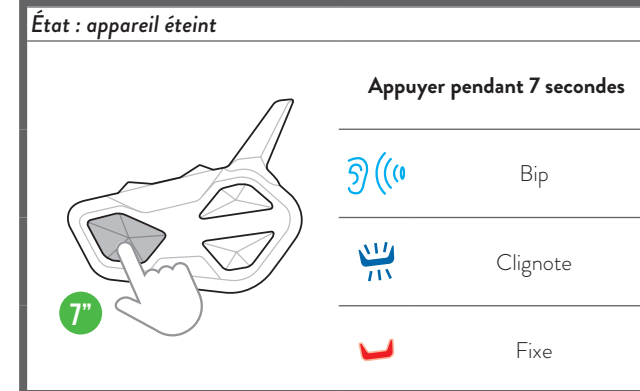

APPAIRAGE TÉLÉPHONE, GPS, TFT

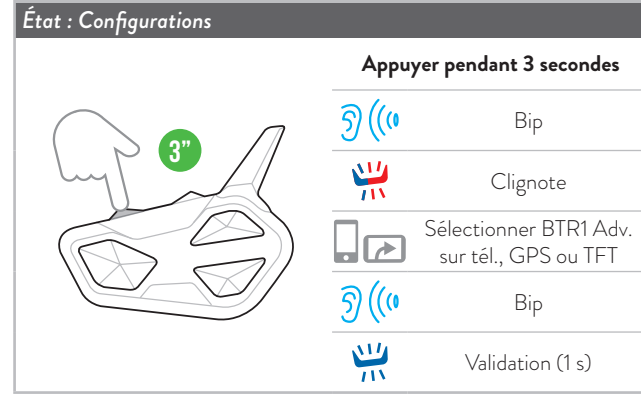

Remarque : pour appairer un 2° appareil en son mono, répéter cette procédure en utilisant Vol -.

APPAIRAGE INTERPHONE MIDLAND

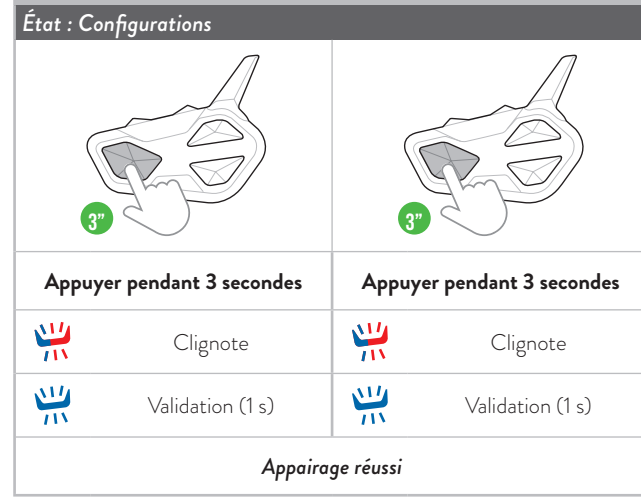

Remarque : pour appairer un autre interphone Midland, suivre la même procédure en utilisant la touche Haut / Bas.

APPAIRAGE INTERPHONE AUTRE MARQUE (UNIVERSAL INTERCOM)

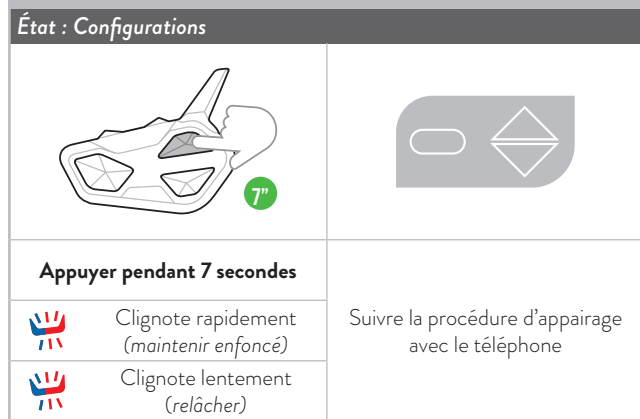

RÉINITIALISATION DES APPAIRAGES BLUETOOTH

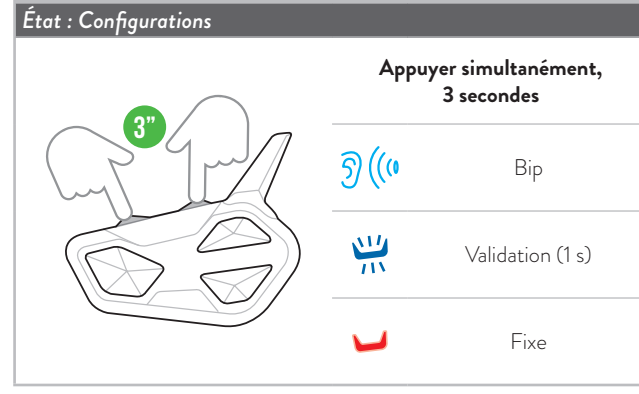

QUITTER LE MODE CONFIGURATIONS INTERROMPRE L'APPAIRAGE



Fréquence (GHz)	Puissance de sortie (mW)
2.402 - 2.480	100

Allez sur le site midlandeurope.com, téléchargez le manuel complet et le logiciel BT Updater.

Personnalisez votre interphone et découvrez toutes les fonctions avec **BTPRO SetApp**. Téléchargez-la ici :



MODES DE FONCTIONNEMENT

- A. **Mode Intercom** : pour communiquer avec un autre appareil.
 B. **Mode téléphone** : pour passer des appels ou gérer la musique.
 C. **Mode radio FM** : pour écouter, chercher et mémoriser des stations radio.

Remarque : Les modes intercom et téléphone ne sont actifs que lorsqu'il y a des appareils appariés avec les touches Vol+/Vol-.

SÉLECTIONNER LE MODE DE FONCTIONNEMENT

État : appareil allumé

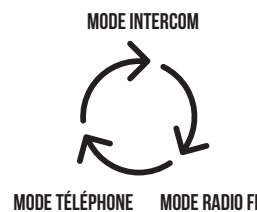

Appuyer pendant 3 secondes pour changer de mode ou maintenir enfoncé pour les faire défiler rapidement

État du mode de fonctionnement

Remarque : en appuyant simultanément sur Vol + et Vol - pendant 1 seconde, BTR1 Advanced communique le mode de fonctionnement sélectionné.

MODE INTERCOM

DESCRIPTION DES FONCTIONS

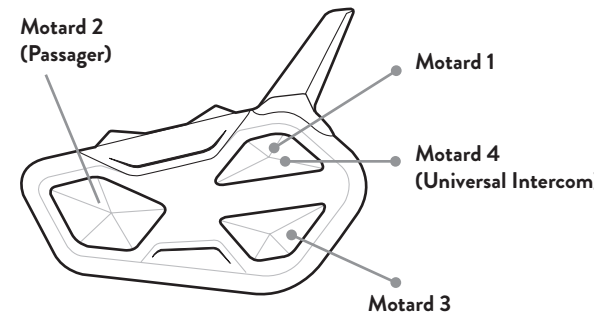

OUVRIR/FERMER INTERCOM MANUELLEMENT

État : mode Intercom



Remarque : pour communiquer avec le Motard 1/3 répéter l'opération en appuyant sur la touche Haut (motard 1) ou Bas (motard 3).

ACTIVER/DÉSACTIVER LE VOX

État : dans tous les modes

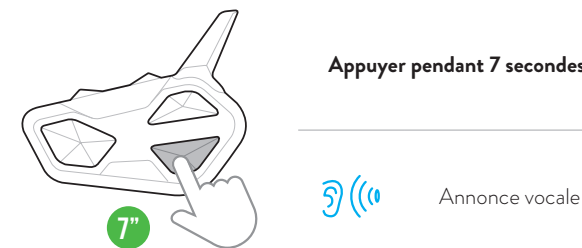

OUVRIR/FERMER L'INTERCOM AVEC LA VOIX

État : dans tous les modes

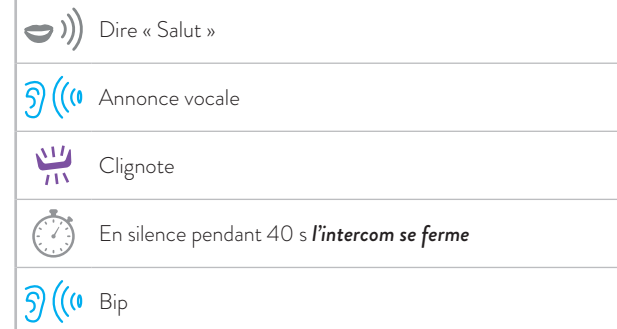

Remarque : l'activation vocale n'est possible qu'avec un interphone apparié avec la touche Contrôle.

RACCOURCI : En mode Intercom/Radio FM, en appuyant 2 fois sur Contrôle vous activez/désactivez la musique.

OUVRIR/FERMER UNIVERSAL INTERCOM

État : mode Intercom

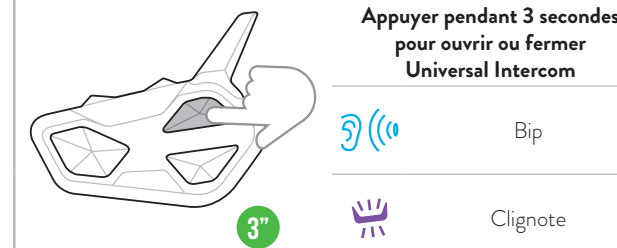

Remarque : pour ouvrir/couper le son depuis l'appareil d'une autre marque, utiliser la commande vocale d'appel (pour certains modèles, il faut envoyer l'appel vocal 2 fois).

ACTIVER/DÉSACTIVER LE CONFÉRENCE

État : en tous les modes

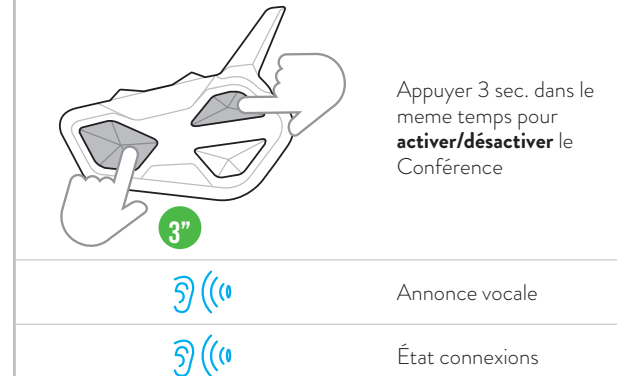

Note: en mode Conférence, les unités couplés à Volt+/- sont momentanément déconnectées

OUVRIR/FERMER LE CONFÉRENCE

État : Conférence

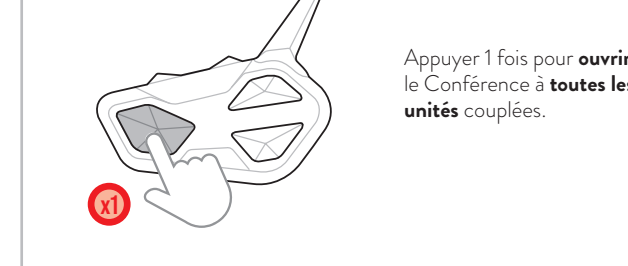
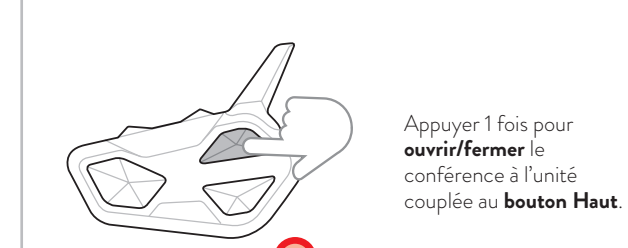

MODE TÉLÉPHONE

DESCRIPTION DES FONCTIONS

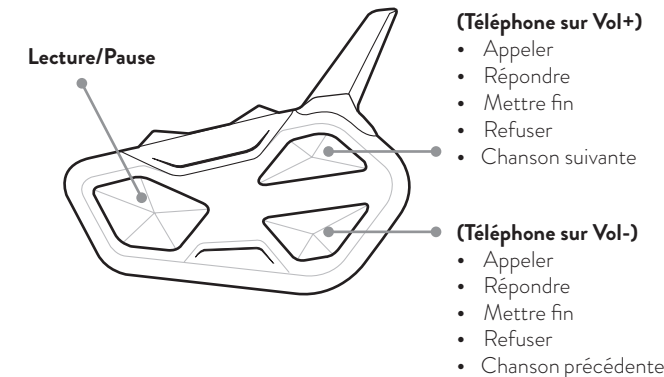

PASSER UN APPEL

État : mode Téléphone

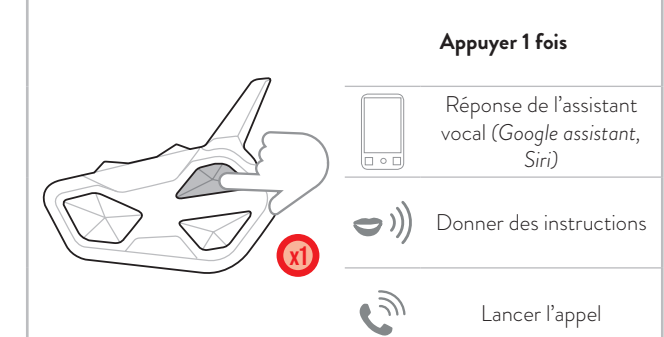

Remarque : si vous avez un téléphone apparié avec la touche Vol -, utilisez la touche Bas.

RACCOURCI : Dans le mode Téléphone, en appuyant 2 fois sur la touche Up/Down vous ouvrez/fermez l'Intercom (Rider 1, 3).

RÉPONDRE/METTRE FIN À UN APPEL REFUSER UN APPEL

État : en tous les modes

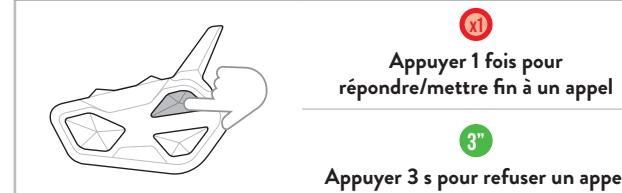

Remarque : si vous avez un téléphone apparié avec la touche Vol -, utilisez la touche Bas.

MUSIQUE

État : mode Téléphone

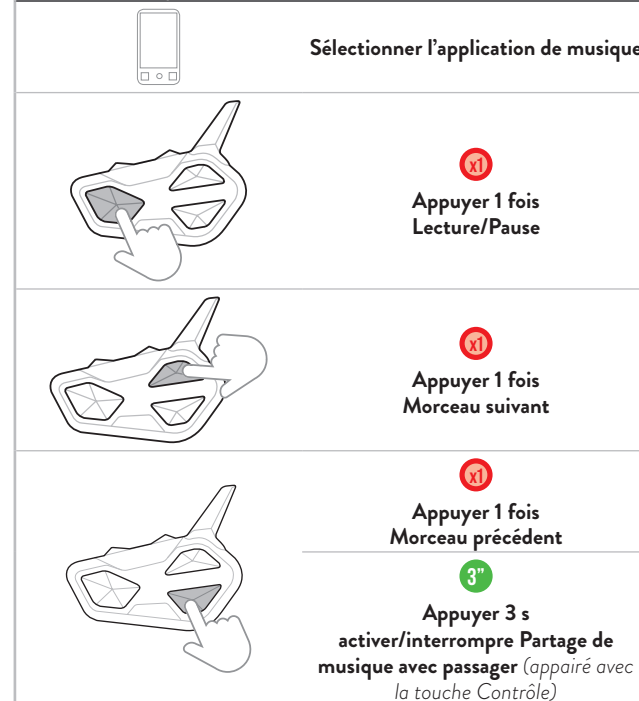

MODE RADIO

DESCRIPTION DES FONCTIONS

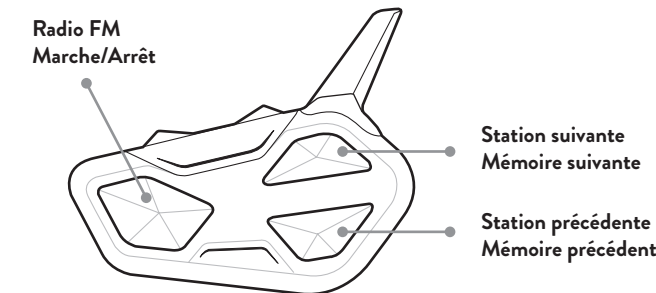

RADIO FM

État : mode Radio

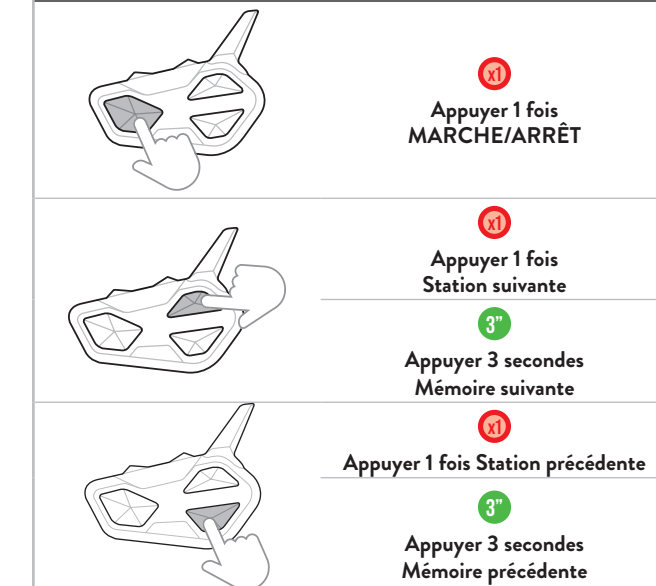

开/关

按键说明

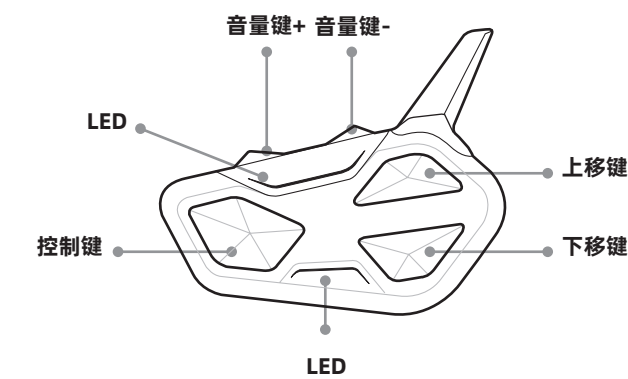

开机

	按住3秒
	“哔”声
	闪烁

关机

	同时按住3秒
	闪烁
	音乐铃声提示

配对

按键说明

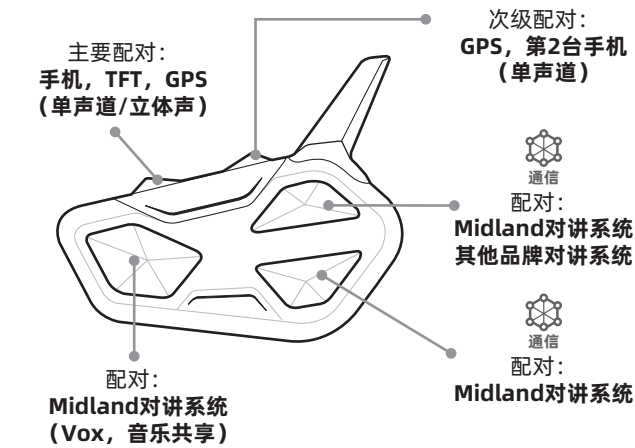

注意: 进行任何系统配对前, 必须先进入设置模式。如果按住控制键的时间不到7秒, 设备会启动而不会进入设置模式。如果出现这种情况, 请重新操作。

进入设置模式

	按住7秒
	“哔”声
	闪烁
	常亮

手机/GPS/TFT配对

状态: 设置

	按住3秒
	“哔”声
	闪烁
	在手机、GPS或TFT设备上选择BT Rush
	“哔”声
	确认 (1秒)

说明: 如需配对第2台单声道设备, 使用音量键-重复上述步骤。

MIDLAND对讲系统配对

状态: 设置

	按住3秒		按住3秒
	闪烁		闪烁
	确认 (1秒)		确认 (1秒)

配对成功

说明: 如需配对另一套Midland对讲系统, 使用上移/下移键, 重复上述步骤进行。

与其他品牌对讲系统配对 (通用对讲系统)

状态: 设置

	按住7秒	按照说明与手机配对
	快速闪烁 (持续按住)	
	缓慢闪烁 (松开)	

与4台通信中的对讲机配对

状态: 设置

说明: 通信模式允许多台设备同时交流。这些设备必须以“链”式配对, 即第一台设备的“下移键”必须与第二台设备的“上移键”配对, 以此类推。如需更多的信息, 请参考用户手册的“通信”部分或教学视频。

重置蓝牙配对

状态: 设置

	同时按住3秒
	“哔”声
	确认 (1秒)
	常亮

退出设置模式 取消配对

状态: 设置

	按2次
	闪烁变化

频率 (GHz)	最大功率 (mW)
2.402 - 2.480	100

前往我们的网站 midlandeurope.com, 下载完整的手册和BT Updater升级软件。

用BT PRO SetApp定制您的对讲系统并发现它的所有功能。
下载地址:

BTR1 ADVANCED 车对车通信交流系统



高清晰度的声音



运行模式

- A. **对讲模式**: 与其他设备通信。
 - B. **手机模式**: 用于手机通话或管理音乐播放。
 - C. **FM收音机模式**: 用于收听、搜索并存储收音机频道。
- 说明: 对讲模式和手机模式只有在与其他设备配对后才会激活。

选择运行模式

状态: 设备启动



按住3秒以改变模式, 或在按住后上下移动进行选择

运行模式状态

说明: 同时按下音量键+和音量键-, BTR1 Advanced将显示所选的运行模式。

对讲模式

功能说明

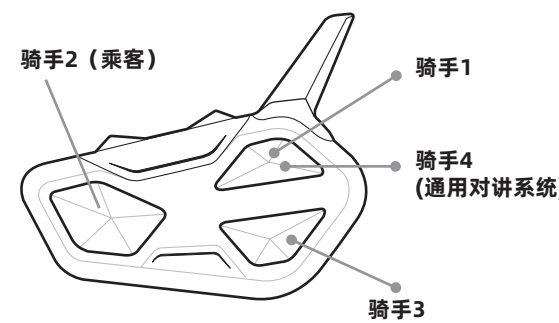

对讲系统手动启动/关闭

状态: 对讲模式



说明: 要与骑手1/3通信, 可重复操作, 按住上移键、(骑手1) / 下移键 (骑手3)。

VOX激活/停用

状态: 所有模式



对讲系统语音启动/关闭

状态: 所有模式

- 说“Hi”
- 语音公告
- 闪烁
- 如果静音40秒, 对讲系统会关闭
- “Hi”声

说明: 只有当一套对讲系统与控制键配对, 才会激活语音助手。

快捷键: 在对讲/FM收音机模式下, 2次按下控制键, 可激活/停用音乐。

通用对讲系统启动/关闭

状态: 对讲模式



说明: 如需从其他品牌的设备激活/停用音频, 请使用语音助手激活指令 (对于有些型号需要发送2次激活信号)。

通信系统启动/停止

状态: 所有模式

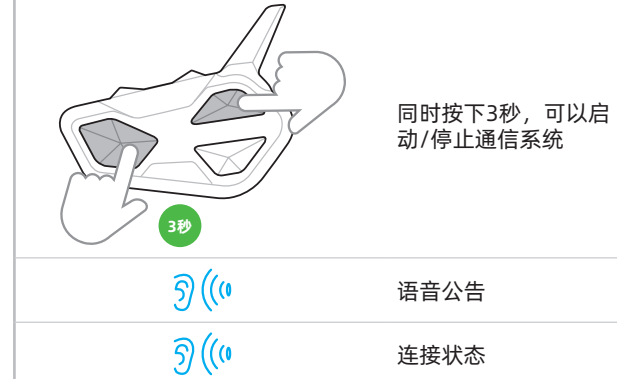

说明: 在通信过程中, 所有与音量键+/-配对的设备会暂时断开。

通信系统打开/关闭

状态: 通信



手机模式

功能说明

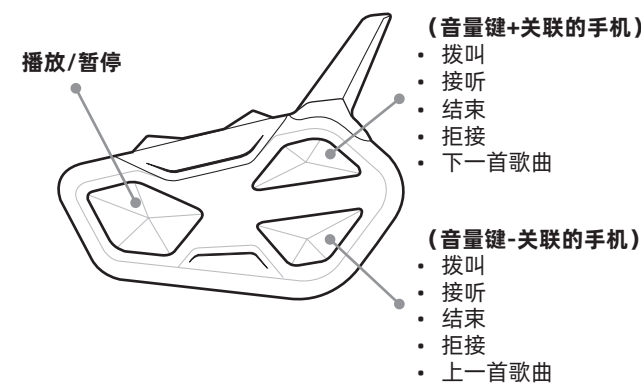

语音呼叫

状态: 手机模式



说明: 如果有一台手机与音量键-配对, 请使用下移键。

快捷键: 在听筒模式下, 按2次上/下键即可打开/关闭关闭对讲机系统 (骑手1, 3)。

接听/停止通话

拒绝接听

状态: 所有模式



说明: 如果有一台手机与音量键-配对, 请使用下移键。

音乐

状态: 手机模式



收音机模式

功能说明

FM收音机开/关

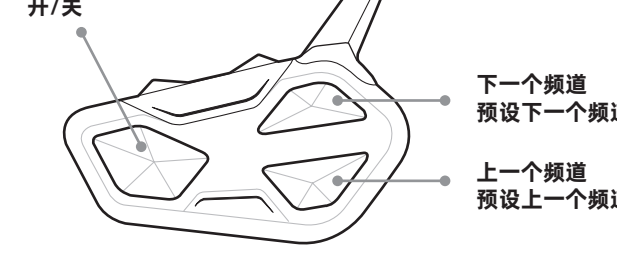

FM收音机

状态: 收音机模式

