

**TOP VIEW**

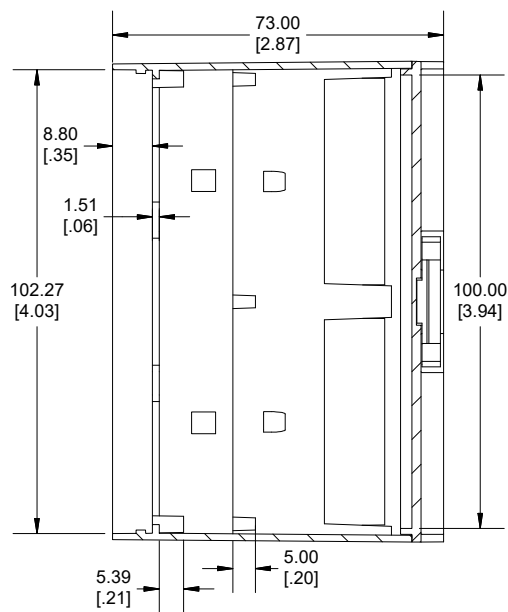

**SECTION B-B**

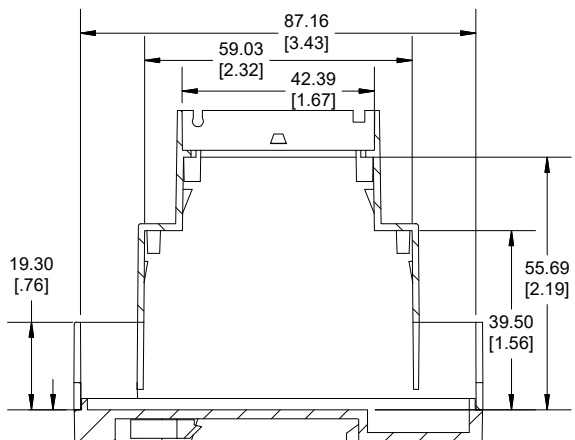
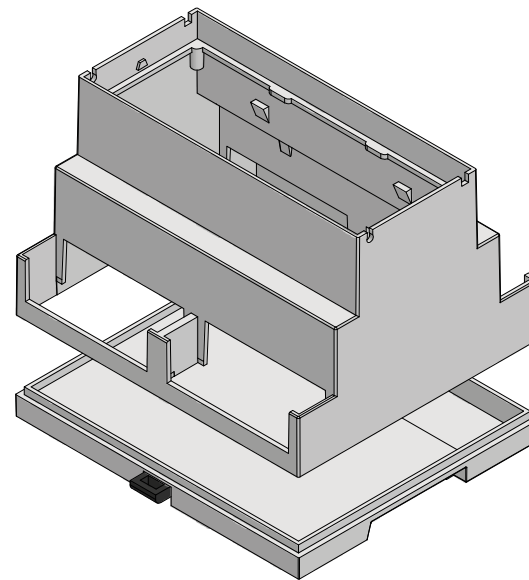

**SECTION A-A**

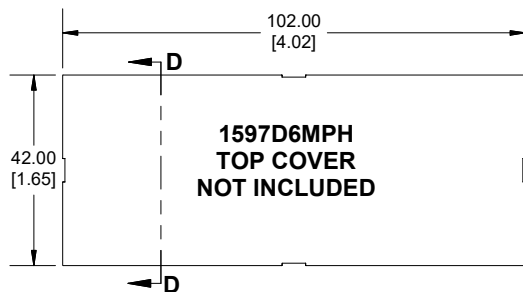

**SECTION D-D**

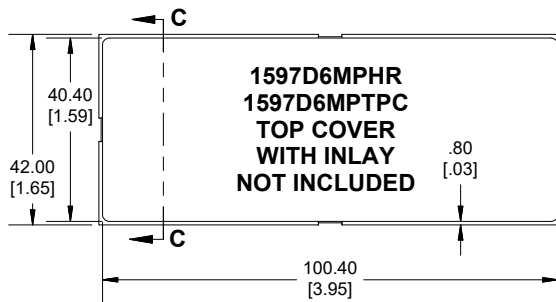
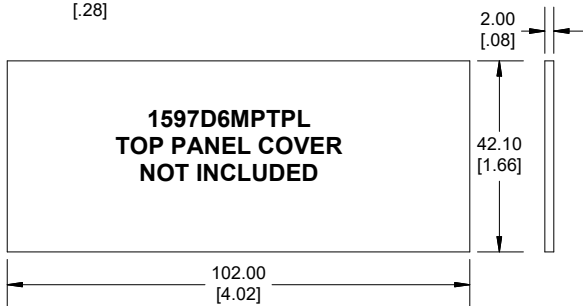
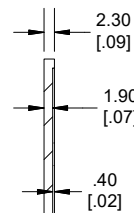

**SECTION C-C**

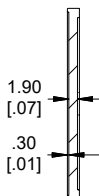

Enclosures can be Factory Modified (Milling, Drilling, Printing etc.)  
 Contact Factory (modshop@hammfg.com) for quotes  
 Solid models of this enclosure available in .stp or .x\_t  
 (Part number and text placement/orientation on our products are subject to change,  
 we do not recommend using them as a locating reference for modification purposes)

**NOTE**

Purchased enclosure includes base, cover and din clip.  
 Cover and base made from PPO.

**PART NUMBERS**

1597DIN	
Enclosure grey Module 6	1597DIN6MDH68
ACCESSORIES	
TOP COVER, GREY	1597D6MPH
TOP COVER WITH INLAY, GREY	1597D6MPHR
TOP COVER WITH INLAY, CLEAR	1597D6MPTPC
TOP PANEL COVER, CLEAR	1597D6MPTPL
TERMINAL COVER BLANK CLOSED	1597D3MTC
TERMINAL COVER WITH HOLES	1597D3MTC6
TERMINAL COVER WITH PUNCH-OUT HOLES	1597D3MTC6O
TERMINAL COVER WITH BUS CONNECTOR	1597D3MBC
TERMINAL COVER BLANK OPEN	1597D3MTCP
BREAD BOARD	1597D4MADP
DIN CLIP	1597DINCLIPXT

TERMINAL COVER  
 DRAWINGS ARE  
 AVAILABLE

**Dimensions:**  
 mm  
 [inches]

**HAMMOND  
 MANUFACTURING®**  
**1597DIN6MDH68**  
 www.hammondmfg.com