

THRASH 212 GO

12" Battery-Powered Loudspeaker

OWNER'S MANUAL

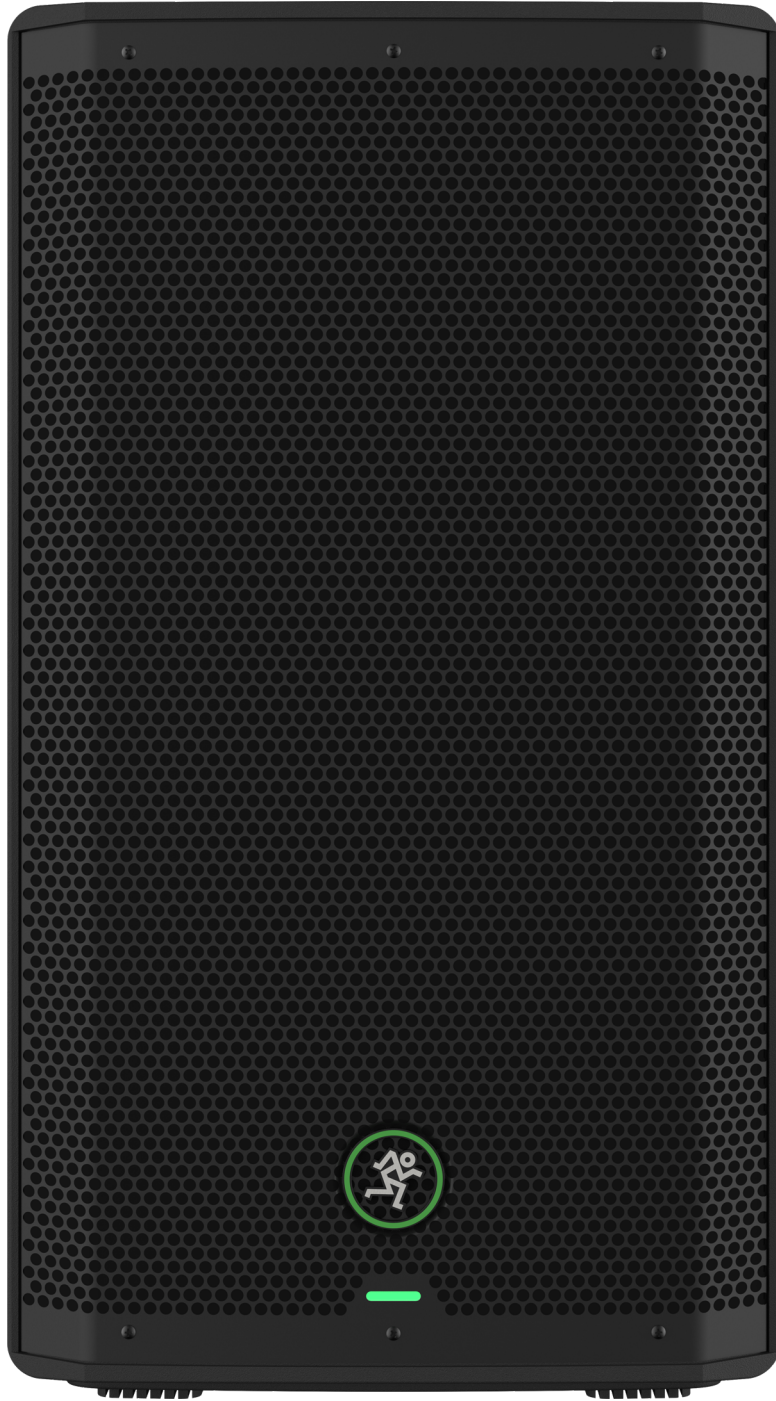

Important Safety Instructions

1. Read these instructions.
2. Keep these instructions.
3. Heed all warnings.
4. Follow all instructions.
5. Do not use this apparatus near water.
6. Clean only with a dry cloth.
7. Do not block any ventilation openings. Install in accordance with the manufacturer's instructions.
8. Do not install near any heat sources such as radiators, heat registers, stoves, or other apparatus (including amplifiers) that produce heat.
9. Protect the power cord from being walked on or pinched particularly at plugs, convenience receptacles, and the point where they exit from the apparatus.
10. Only use attachments/accessories specified by the manufacturer.
11. Use only with a cart, stand, tripod, bracket, or table specified by the manufacturer, or sold with the apparatus. When a cart is used, use caution when moving the cart/apparatus combination to avoid injury from tip-over.
12. Unplug this apparatus during lightning storms or when unused for long periods of time.
13. Refer all servicing to qualified service personnel. Servicing is required when the apparatus has been damaged in any way, such as power-supply cord or plug is damaged, liquid has been spilled or objects have fallen into the apparatus, the apparatus has been exposed to rain or moisture, does not operate normally, or has been dropped.
14. This apparatus shall not be exposed to dripping or splashing, and no object filled with liquids, such as vases or beer glasses, shall be placed on the apparatus.
15. Do not overload wall outlets and extension cords as this can result in a risk of fire or electric shock.



CAUTION

RISK OF ELECTRIC SHOCK! DO NOT OPEN!

CAUTION: TO REDUCE THE RISK OF ELECTRIC SHOCK DO NOT REMOVE COVER (OR BACK). NO USER-SERVICEABLE PARTS INSIDE. REFER SERVICING TO QUALIFIED PERSONNEL.

The lightning flash with arrowhead symbol within an equilateral triangle is intended to alert the user to the presence of uninsulated "dangerous voltage" within the product's enclosure, that may be of significant magnitude to constitute a risk of electric shock to persons.

The exclamation point within an equilateral triangle is intended to alert the user of the presence of important operating and maintaining (servicing) instructions in the literature accompanying the appliance.

16. **NOTE:** This equipment has been tested and found to comply with the limits for a Class B digital device, pursuant to part 15 of the FCC Rules. These limits are designed to provide reasonable protection against harmful interference in a residential installation. This equipment generates, uses, and can radiate radio frequency energy and, if not installed and used in accordance with the instructions, may cause harmful interference to radio communications. However, there is no guarantee that interference will not occur in a particular installation. If this equipment does cause harmful interference to radio or television reception, which can be determined by turning the equipment off and on, the user is encouraged to try to correct the interference by one or more of the following measures:
 - Reorient or relocate the receiving antenna.
 - Increase the separation between the equipment and the receiver.
 - Connect the equipment into an outlet on a circuit different from that to which the receiver is connected.
 - Consult the dealer or an experienced radio/TV technician for help.

CAUTION: Changes or modifications to this device not expressly approved by LOUD Audio, LLC could void the user's authority to operate the equipment under FCC rules.
17. This device complies with FCC/IC RSS-102 radiation exposure limits set forth for an uncontrolled environment. This device should be installed and operated with minimum distance 20cm between the radiator & your body.
18. The maximum ambient temperature during use of the appliance must not exceed 45° C.
19. Operation frequency: 2400MHz – 2483.5MHz
20. RF POWER = <20dBm

21. This apparatus has been designed with Class-I construction and must be connected to a mains socket outlet with a protective earthing connection (the third grounding prong).
22. This apparatus does not exceed the Class A/Class B (whichever is applicable) limits for radio noise emissions from digital apparatus as set out in the radio interference regulations of the Canadian Department of Communications.

ATTENTION — *Le présent appareil numérique n'émet pas de bruits radioélectriques dépassant les limites applicables aux appareils numériques de class A/de class B (selon le cas) prescrites dans le règlement sur le brouillage radioélectrique édicté par les ministere des communications du Canada.*
23. This device complies with Part 15 of the FCC Rules [and contains license-exempt transmitter(s)/receiver(s) that comply with Innovation, Science and Economic Development Canada's license-exempt RSS(s)]. Operation is subject to the following two conditions:
 - (1) this device may not cause harmful interference, and
 - (2) this device must accept any interference received, including interference that may cause undesired operation.

L'émetteur/récepteur exempt de licence contenu dans le présent appareil est conforme aux CNR d'Innovation, Sciences et Développement économique Canada applicables aux appareils radio exempts de licence. L'exploitation est autorisée aux deux conditions suivantes:

 - (1) l'appareil ne doit pas produire de brouillage, et
 - (2) l'appareil doit accepter tout brouillage radioélectrique subi, même si le brouillage est susceptible d'en compromettre le fonctionnement.
24. Exposure to extremely high noise levels may cause permanent hearing loss. Individuals vary considerably in susceptibility to noise-induced hearing loss, but nearly everyone will lose some hearing if exposed to sufficiently intense noise for a period of time. The U.S. Government's Occupational Safety and Health Administration (OSHA) has specified the permissible noise level exposures shown in the following chart.

According to OSHA, any exposure in excess of these permissible limits could result in some hearing loss. To ensure against potentially dangerous exposure to high sound pressure levels, it is recommended that all persons exposed to equipment capable of producing high sound pressure levels use hearing protectors while the equipment is in operation. Ear plugs or protectors in the ear canals or over the ears must be worn when operating the equipment in order to prevent permanent hearing loss if exposure is in excess of the limits set forth here:

Duration, per day in hours	Sound Level dBA, Slow Response	Typical Example
8	90	Duo in small club
6	92	
4	95	Subway Train
3	97	
2	100	Very loud classical music
1.5	102	
1	105	Matt screaming at Troy about deadlines
0.5	110	
0.25 or less	115	Loudest parts at a rock concert

WARNING — To reduce the risk of fire or electric shock, do not expose this apparatus to rain or moisture.

CAUTION — To prevent electric shock hazard, do not connect to mains power supply while grille is removed.

WARNING — The battery (battery or batteries or battery pack) shall not be exposed to excessive heat such as sunshine, fire or the like.

CAUTION — Danger of explosion if battery is incorrectly replaced. Replace only with the same or equivalent type.

Laite on liitettävä suojakoskettimilla varustettuun pistorasiaan.

Apparatet stikprop skal tilsluttes en stikkontakt med jord, som giver forbindelse til stikproppens jord.

Apparatet må tilkoples jordet stikkontakt.

Apparaten skall anslutas till jordat uttag.



Correct disposal of this product: This symbol indicates that this product should not be disposed of with your household waste, according to the WEEE directive (2012/19/EU) and your national law. This product should be handed over to an authorized collection site for recycling waste electrical and electronic equipment (EEE). Improper handling of this type of waste could have a possible negative impact on the environment and human health due to potentially hazardous substances that are generally associated with EEE. At the same time, your cooperation in the correct disposal of this product will contribute to the effective usage of natural resources. For more information about where you can drop off your waste equipment for recycling, please contact your local city office, waste authority, or your household waste disposal service.

Features

Important Safety Instructions	2
Features / Contents	3
Introduction / Getting Started	4
Hookup Diagrams	5
Thrash212 GO: Rear Panel Features.....	9
1. Power Connection	9
2. Power Switch	9
3. XLR and 1/4" Combo Input Jacks.....	9
4. Gain Knobs [Ch. 1 and 2]	10
5. Thru Jack	10
6. Main Volume Knob.....	10
7. Bluetooth / Pair.....	10
8. Speaker Link	11
9. Battery LED.....	11
10. Power / Overload LED.....	11
Final Thoughts	12
Factory Reset	12
Battery Replacement	12
Protection Circuitry.....	13
Limiting.....	13
Overexcursion Protection	13
Thermal Protection.....	13
AC Power	14
Care and Maintenance	14
Placement	14
Room Acoustics	15
Appendix A: Service Information.....	16
Appendix B: Technical Information	17
Thrash212 GO Block Diagram.....	18
Thrash212 GO Dimensions.....	19
Limited Warranty	20

Contents

- 12" Battery-Powered Loudspeaker**
- Up to 10 hours of playtime with included swappable, rechargeable battery**
- Ultra-efficient, 300W Class D amplifier**
- Bluetooth® streaming**
- Link via Bluetooth to a second Thrash212 GO for stereo music playback**
- Built-Like-A-Tank™ to conquer every gig while lightweight for easy loading**



Introduction

Thrash212 GO is a full-size, battery-powered loudspeaker that delivers professional sound, anywhere.

Forget long power cable runs—the swappable, rechargeable battery lasts up to 10 hours, so you can take your music to new places.

With onboard Bluetooth® connectivity, you can link to a second Thrash212 GO in stereo for a completely wireless music streaming system.

Thrash212 GO offers Mackie-level performance thanks to ultra-efficient Class-D amplification and specially selected components for high-output punch and clear sound despite running on a battery.

Whether you're at a beach wedding or in a 100-year-old building with questionable wiring, you'll always be prepared to go off the grid with the Thrash212 GO.

How to Use This Manual:

After this introduction, a getting started guide will help you get things set up fast. The hookup diagrams show some typical Thrash212 GO loudspeaker setups, including some that involve a Mackie subwoofer.



This icon marks information that is critically important or unique! For your own good, read and remember them...it is a good idea to pay special attention to these areas in the Owner's Manual marked with the "VERY IMPORTANT" hand icon.



There's an illustration of a microscope, so, of course, you're going to get more detailed information when you see this little guy. There are explanations of features and practical tips listed here.



It's a good idea to pay attention to text displayed next to a note icon, as this icon draws attention to certain features and functions relating to the usage of the Thrash212 GO.

Please write the serial numbers here for future reference (i.e., insurance claims, tech support, return authorization, make dad proud, etc.)

Purchased at:

Date of purchase:

Getting Started

The following steps will help you set up the Thrash212 GO quickly.

1. Make all initial connections with the power switches OFF on all equipment. Make sure the master volume, level and gain controls are all the way down.
2. If not using a subwoofer, connect the outputs from the mixing console (or other signal source) to the inputs on the rear panel of the loudspeakers.
3. If using a subwoofer, connect the outputs from the mixing console (or other signal source) to the inputs on the subwoofer, then connect the high pass outputs from the subwoofer to the inputs of the loudspeakers.
4. Push the line cord securely into the subwoofer's / loudspeaker's IEC connectors and plug the other ends into grounded AC outlets. The subwoofer/loudspeaker may accept the appropriate voltage as indicated near the IEC connector.
5. Turn the mixer (or other signal source) on.
6. Turn the subwoofer on (if applicable).
7. Turn the loudspeakers on.
8. Make sure the loudspeaker's channel gain knob(s) are set to mic or line.
9. Be sure that the volume of the input is the same as it would be during normal use.
10. Start the signal source and raise the mixer's main L/R fader up to a comfortably loud listening level.

Things to Remember:

- Never listen to loud music for prolonged periods. Please see the Safety Instructions on page 2 for information on hearing protection.
- As a general guide, the mixer (or other signal source) should be turned on first, subwoofers next, and the Thrash212 GO last. As such, the Thrash212 GO should also be turned off first, followed by the subwoofers, then the mixer. This will reduce the possibility of any turn-on or turn-off thumps and other noises generated by any upstream equipment from coming out of the speakers.
- Save the shipping boxes and packing materials! You may need them someday. Besides, the cats will love playing in them and jumping out at you unexpectedly. Remember to pretend like you are surprised!
- Save your sales receipt in a safe place.
- Most importantly, never forget that Thrash212 will always remember 'your song'.

Hookup Diagrams

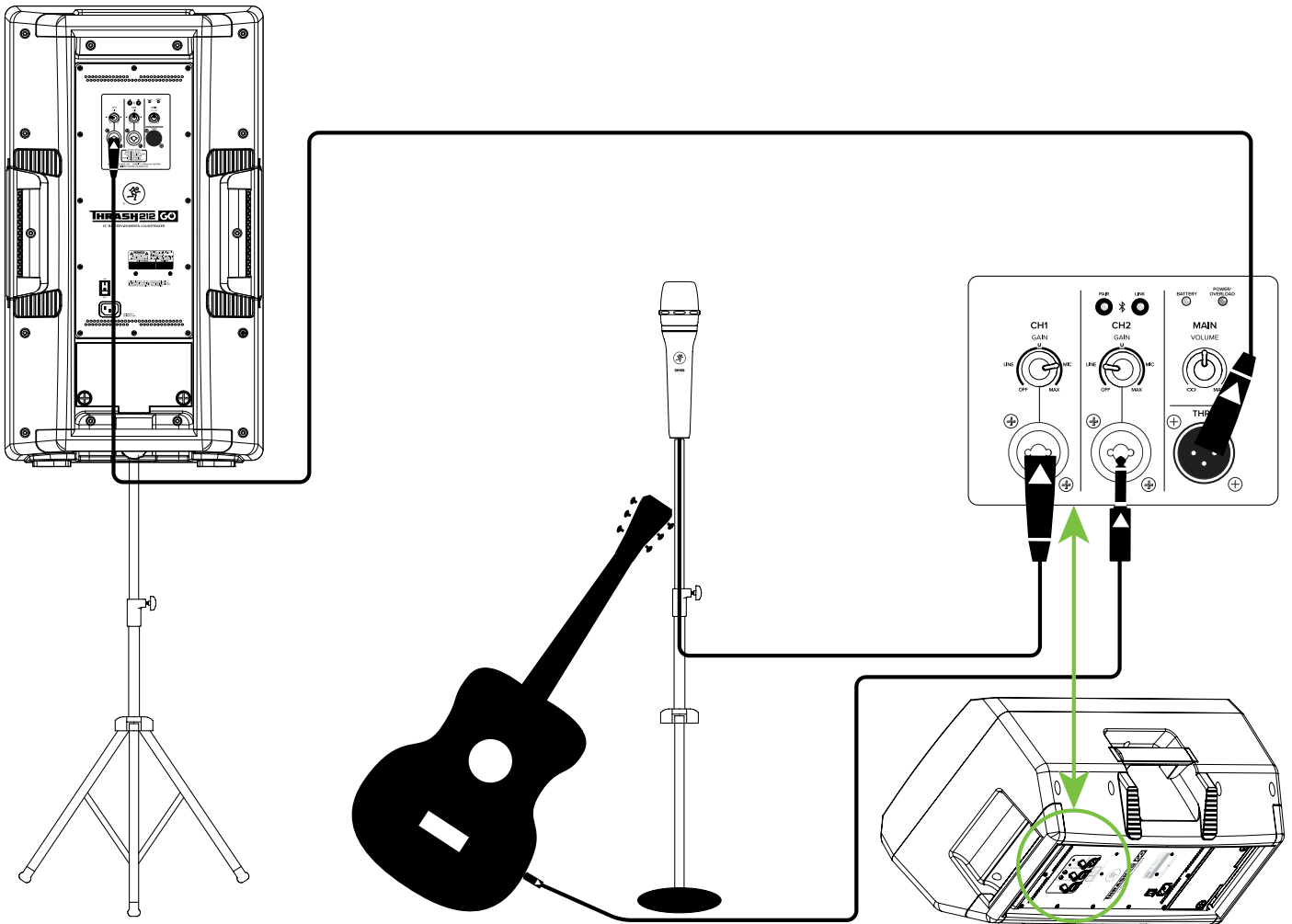

Thrash212 GO loudspeakers are the perfect tool for singer-songwriters touring the local coffee shops. Bring your favorite axe and mic, Thrash212 GO loudspeakers and cables and power cords.

In this example, a Mackie EM-89D dynamic microphone is connected to the channel 1 input of a Thrash212 GO, used for monitoring purposes. The gain knob should be set to mic.

Now grab your axe and plug it directly into the channel 2 input. Or if you use effects, connect the guitar to the effects input and another cable from the effects output to the channel 2 input. The gain knob should be set to line.

Another Thrash212 GO loudspeaker will be used for the main PA. Simply connect a cable from the Thrash212 GO monitor's THRU jack to the Thrash212 GO PA's channel 1 input.

Singer-Songwriter Setup

Hookup Diagrams continued...

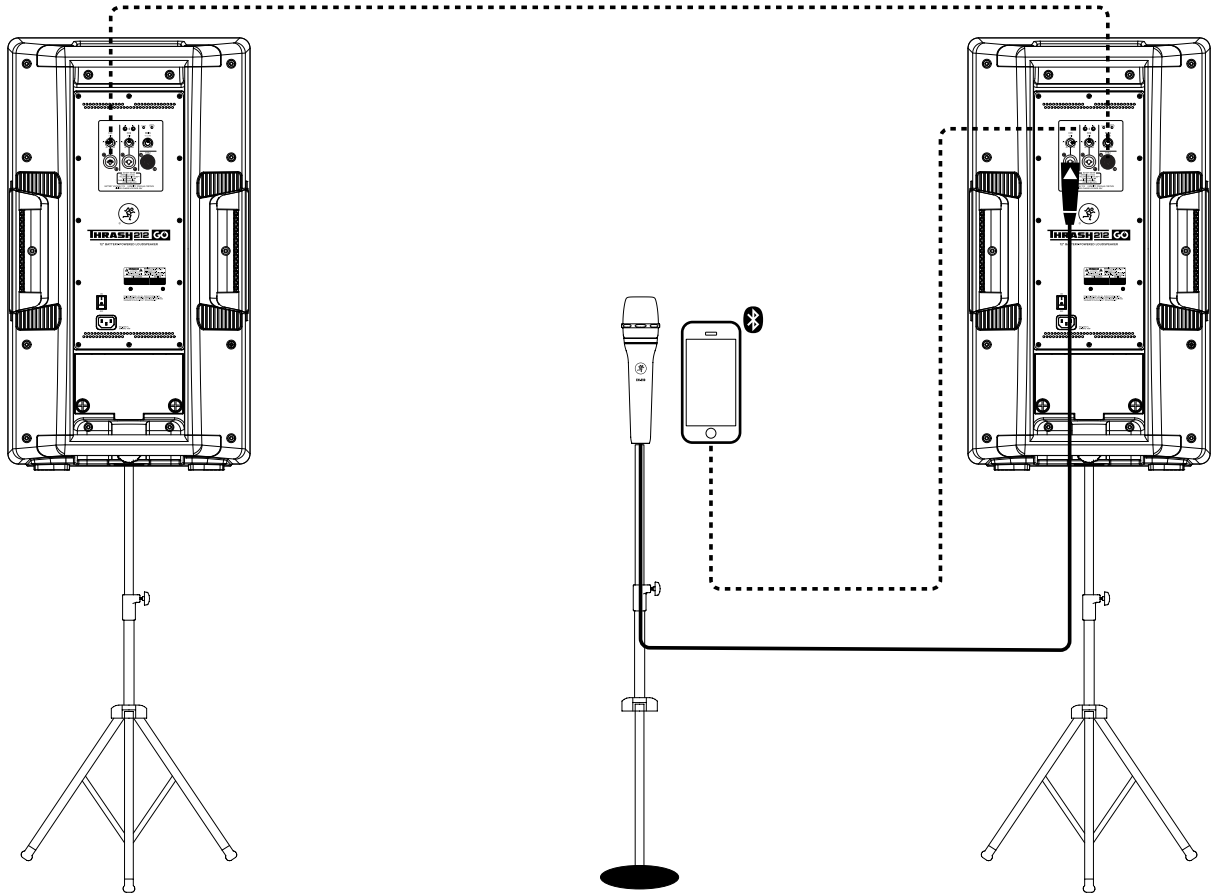

Thrash212 GO loudspeakers are great for house parties, BBQs, karaoke competitions and picnics, too!

In this example, we connected a Mackie EM-89D dynamic microphone to the channel 1 input of a Thrash212 GO. The gain knob should be set to mic. Additionally, a phone is connected via Bluetooth for music playback. Make sure that the volume of the phone is up!

Another Thrash212 GO loudspeaker will be used for extra “punch”. Simply connect a cable from the first Thrash212 GO’s THRU jack to the other Thrash212 GO’s channel 1 input. The gain knob of this input should be set to line.

House Parties / BBQ / Karaoke / Picnic System

Hookup Diagrams continued...

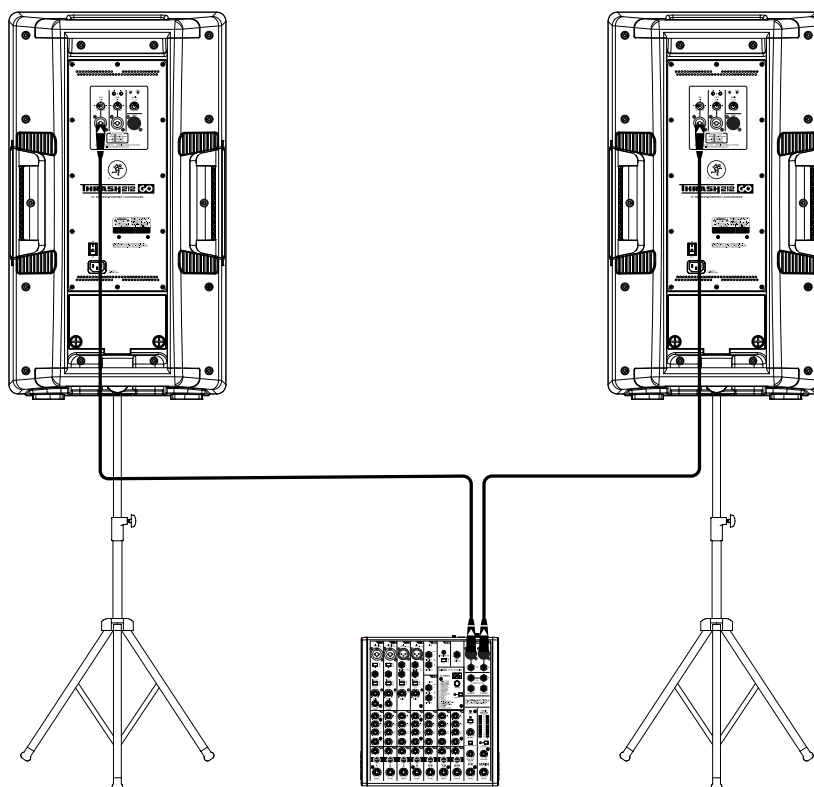

In this example, a ProFX10v3 mixer is connected directly to two Thrash212 GO loudspeakers. It is the perfect setup for a small club. Simply connect the L/R outputs of the ProFX10v3 mixer to the channel 1 input of each Thrash212 GO loudspeaker. The gain knob on both should be set to Line.

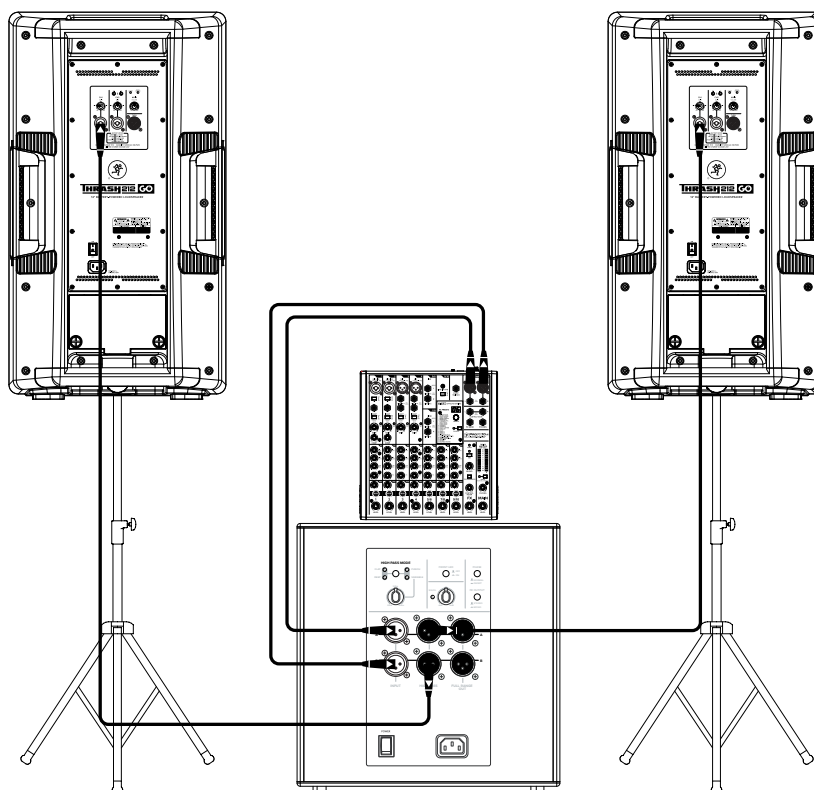

If you desire a little more boom, add a subwoofer to the mix. Here, the L/R outputs of a ProFX10v3 mixer are connected directly to the channel A and B inputs of a Thump118S subwoofer. Then the High-Pass Outs of the subwoofer are connected to the channel 1 inputs of a pair of Thrash212 GO loudspeakers. The gain knob on both should be set to Line.

Small Club System

Hookup Diagrams continued...

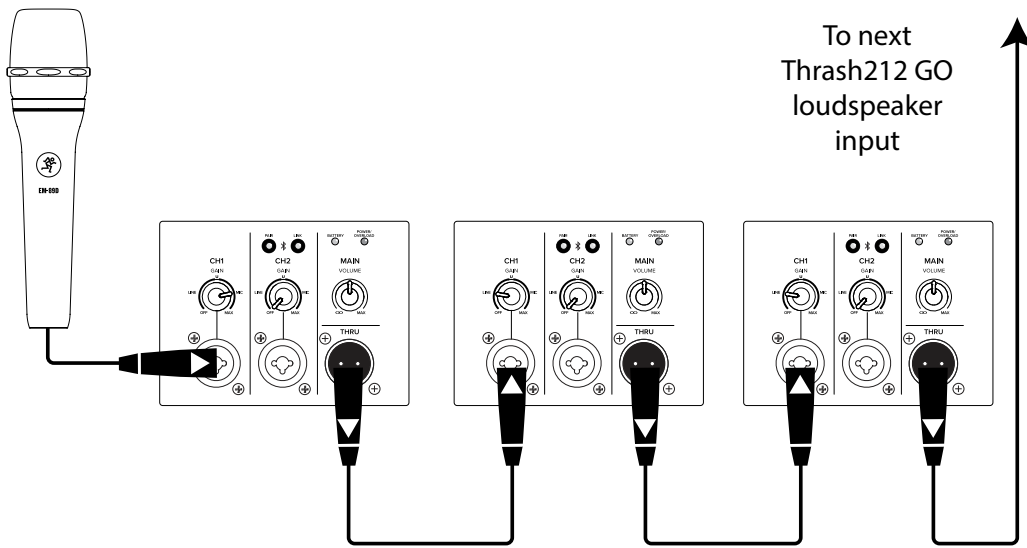
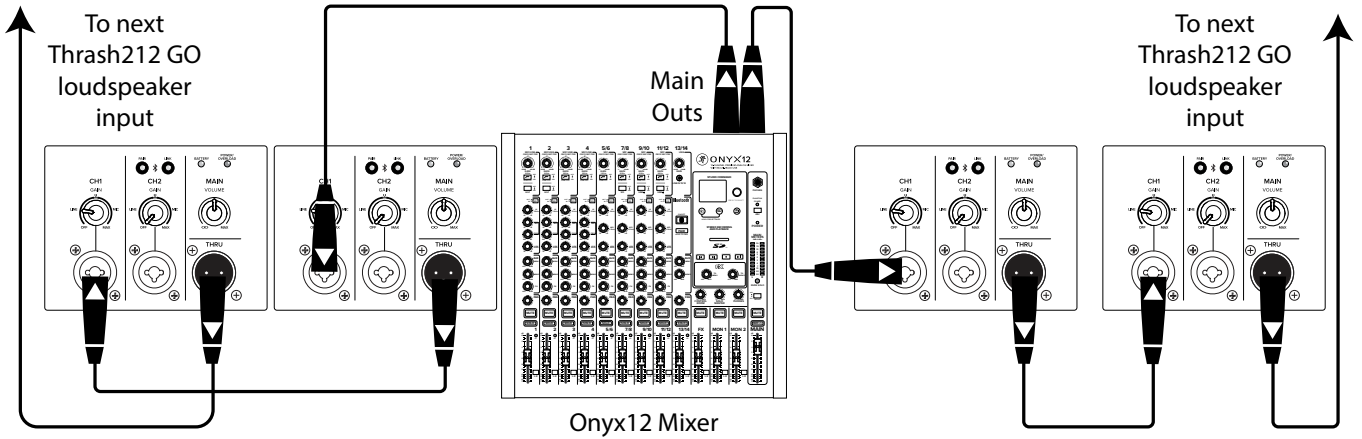

Thrash212 GO loudspeakers may be daisy-chained via the male XLR connector labeled “THRU”. Simply plug the signal source (i.e., mixer output or microphone) into the input jack(s), and patch that loudspeaker’s thru jack to the next loudspeaker’s input jack, and so on, daisy-chaining multiple Thrash212 GO loudspeakers. See above for visual representations of daisy-chaining.

NOTE: Make sure to set the gain knob(s) correctly. In the top diagram, all channel 1 inputs are set to “LINE” and in the bottom diagram, input channel 1 of the first Thrash212 GO is set to “MIC”, but the remaining ones should be set to “LINE”. Keep in mind that these “MIC” and “LINE” markings are for reference only and may need to be raised or lower.

Daisy-Chaining Multiple Thrash212 GO Loudspeakers

Thrash212 GO: Rear Panel Features

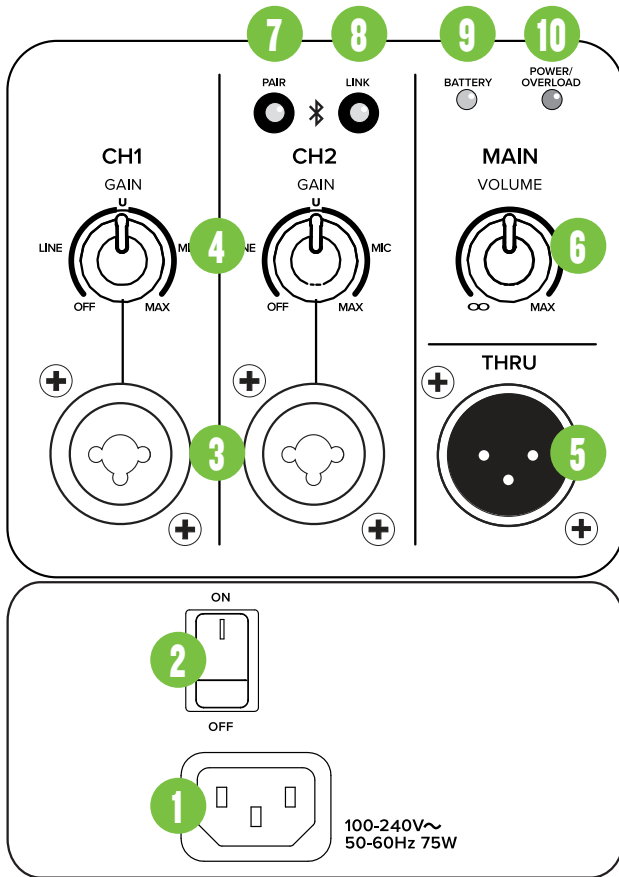

1. Power Connection

This is a standard 3-prong IEC power connector. Connect the detachable power cord (included in the packaging with the Thrash212 GO) to the power receptacle, and plug the other end of the power cord into an AC outlet.

VERY IMPORTANT Make sure that the AC power is matched to the AC power indicated on the rear panel (near the IEC receptacle).

VERY IMPORTANT Disconnecting the plug's ground pin is dangerous. Don't do it!

2. Power Switch

Press the top side of this rocker switch inwards to turn on the Thrash212 GO. Press the bottom side of this rocker switch inwards to turn off the Thrash212 GO.

VERY IMPORTANT As a general guide, the mixer (or other signal source) should be turned on first, subwoofers next, and loudspeakers last. As such, the loudspeakers should also be turned off first, followed by the subwoofers, then the mixer. This will reduce the possibility of any turn-on or turn-off thumps and other noises generated by any upstream equipment from coming out of the speakers.

3. XLR and 1/4" Combo Input Jacks

Input channels 1 and 2 may accept a balanced XLR connector. Both channels accept line-level inputs, as well. They are wired as follows, according to standards specified by the AES (Audio Engineering Society).

XLR Balanced Wiring:

- Pin 1 = Shield (ground)
- Pin 2 = Positive (+ or hot)
- Pin 3 = Negative (- or cold)

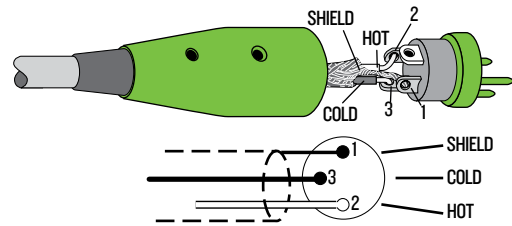

In addition to accepting a balanced mic signal using an XLR connector, these input channels may also accept 1/4" line-level signals driven by balanced or unbalanced sources.

To connect balanced lines to these inputs, use a 1/4" Tip-Ring-Sleeve (TRS) plug. "TRS" stands for Tip-Ring-Sleeve, the three connection points available on a stereo 1/4" or balanced phone jack or plug. TRS jacks and plugs are used for balanced signals and are wired as follows:

1/4" TRS Balanced Mono Wiring:

- Sleeve = Shield
- Tip = Hot (+)
- Ring = Cold (-)

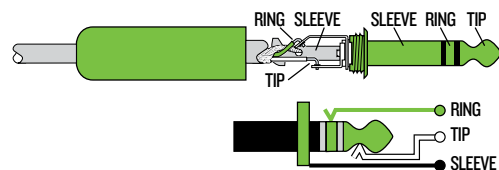

To connect unbalanced lines to these inputs, use a 1/4" mono (TS) phone plug, wired as follows:

1/4" TS Unbalanced Mono Wiring:

- Sleeve = Shield
- Tip = Hot (+)

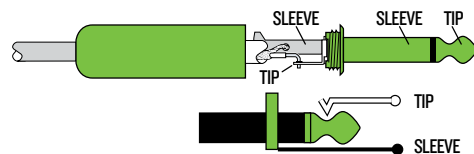

VERY IMPORTANT NEVER connect the output of an amplifier directly to a Thrash212 GO input jack. This could damage the input circuitry!

Thrash212 GO: Rear Panel Features continued...

4. Gain Knobs

If you haven't already, please read the "Quick Start" section on page 4. Setting the gain correctly will ensure that the preamplifier's gain is not too high, where distortion could occur, and not too low, where the quieter, exquisitely-delicate passages might be lost in background noise.

The gain knobs – in conjunction with the overload LED – adjust the input sensitivity of the mic and line inputs. This allows signals from the outside world to be adjusted to run through each channel at optimal internal operating levels.



If connecting mixer outputs to Thrash212 GO inputs, set the gain knobs to 9:00 ["LINE"] for optimal sound and performance.



Keep in mind that these "MIC" and "LINE" markings are for reference only and may need to be raised or lower.

5. Thru Jack

This is a balanced male XLR-type connector that produces a mono-summed pre-DSP mix from all input jacks. It is not affected by the main volume. Use it to connect an additional Thrash212 GO or subwoofer off of the same signal source.

It is wired as follows, according to standards specified by the AES (Audio Engineering Society):

Balanced XLR Output Connector

- Pin 1 – Shield (ground)
- Pin 2 – Positive (+ or hot)
- Pin 3 – Negative (- or cold)

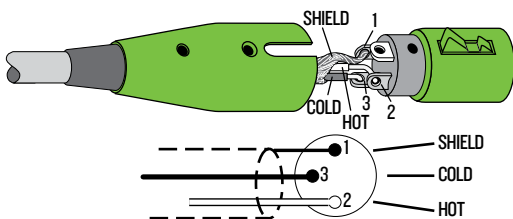

6. Main Volume Knob

The level knob adjusts the overall signal level at the input to the built-in power amplifiers. It ranges from off ($-\infty$) to MAX (maximum gain).

- Thrash212 GO is designed to operate with a +4 dBu average line signal when the main knob and the line input gain are at the center position.

- Thrash212 GO may accept up to a +20 dBu line signal by turning down the line input gain accordingly.

- Turning the main knob past center position will provide enough gain to connect a microphone directly. Most microphones will want the knob somewhere around the 9:00 position. For safety, if you're plugging in a mic, start with the volume off and gradually rotate it clockwise until you achieve the desired volume... and be on the lookout for the dreaded shriek of the feedback monster.

7. Bluetooth / Pair

While not a "physical" connection, stereo channel 3/4 is considered the Bluetooth channel and its volume is raised and lowered via the device.

This is how to connect your device to the Thrash212 GO via Bluetooth! Read on...

Upon powering up the Thrash212 GO, the Bluetooth function is either:

- (1) In sleep mode. See 'Pairing and connecting for the first time' (below) or...

- (2) ...Paired and connected. See 'Previously paired and connected devices' (also below).

Pairing and connecting for the first time:

To enter pairing mode, press and hold the pair switch down for two to three seconds. The LED will illuminate and slow flash blue for approximately 60 seconds while in pairing mode. [The LED will continue to flash until it has successfully paired and connected].

While Thrash212 GO is in pairing mode, simultaneously scan for Bluetooth devices on your device. You should see Thrash212 GO appear in the list of "available devices". Select it by tapping it. From there, your Bluetooth device should indicate that it is successfully connected. Additionally, the pair button will stop flashing and remain solid blue. If it does not, start the pairing process again, and make sure that Thrash212 GO and your device are both in pairing mode at the same time.

Thrash212 GO: Rear Panel Features continued...

Previously paired and connected devices:

The Bluetooth connection will disconnect if it's out of range or if Thrash212 GO is powered off. Previously paired and connected devices will automatically reconnect and the pair button will once again illuminate a brilliant blue.

NOTE To drop the device from being paired with the Thrash212 GO, press and hold the 'Bluetooth Pair' button down for two to three seconds.

VERY IMPORTANT The Bluetooth connection may disconnect when affected by electrostatic discharge (ESD) or electrical fast transients (EFT). If this occurs, manually reconnect the Bluetooth connection.

VERY IMPORTANT If a phone – or two different phones – have been paired via Bluetooth with two Thrash212 GO loudspeakers, they will not link. The options are either (1) one phone connected via Bluetooth and Thrash212 GO loudspeakers may be linked or (2) two phones connected via Bluetooth to two different Thrash212 GO loudspeakers and they may be not be linked.

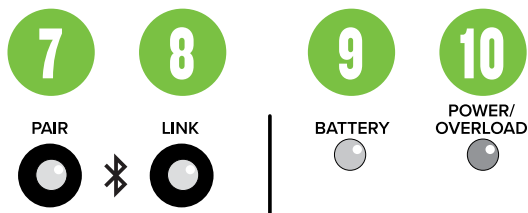

8. Speaker Link

Two Thrash212 GO loudspeakers may either be linked together or separate (i.e. not linked).

To link:

In order to link two Thrash212 GO loudspeakers, press and hold the 'Link' momentary switch / LED down on the primary Thrash212 GO loudspeaker until the blue LED illuminates and begins slow-flashing.

Within (approximately) 60 seconds, a quick press and release of the 'Link' button on the secondary Thrash212 GO allows both units to "see" each other, handshake and link. The LEDs on both units will stop flashing and remain solid, indicating great success!

NOTE The Thrash212 GO loudspeakers will continue to auto-link on every power-up.

To unlink:

In order to unlink the two Thrash212 GO loudspeakers, press and hold the 'Link' momentary switch / LED down on one of the Thrash212 GO loudspeakers until the blue LED turns off. The other Thrash212 GO will automatically unlink and the LEDs on both units will turn off.

VERY IMPORTANT If a phone – or two different phones – have been paired via Bluetooth with two Thrash212 GO loudspeakers, they will not link. The options are either (1) one phone connected via Bluetooth and Thrash212 GO loudspeakers may be linked or (2) two phones connected via Bluetooth to two different Thrash212 GO loudspeakers and they may be not be linked.

9. Battery LED

This tri-colored LED displays the remaining battery life. The battery life meter is silkscreened on the rear panel just below the channel 2 combo jack. The percentages are also listed below:

- Green = 20% – 100% battery life remaining
- Yellow = 5% – 20% battery life remaining
- Red = less than 5% battery life remaining
- Flashing = Battery charging
- No LED = No battery detected

BATTERY METER	
GREEN	ALL GOOD
YELLOW	GETTING SLEEPY
RED	CHARGE ME
FLASHING	CHARGING
OFF	NO BATTERY

10. Power / Overload LED

This dual-colored LED will illuminate green when the loudspeaker is turned on, as a reminder of how on it really is. If it is not on, then it is off, and the loudspeaker becomes a rather nice weight for keeping your morning newspaper from blowing away in the wind.

If it does not turn on, make sure that (1) the power cord is correctly inserted at both ends, the local AC mains supply is active and the power switch is on, or (2) the battery has life if not going the electric route.

Thrash212 GO also has a built-in limiter that helps to prevent the amplifier outputs from clipping or overdriving the transducers. The LED illuminates red when the limiter is activated. If this occurs, turn down the gain knob.

VERY IMPORTANT Excessive limiting may lead to overheating, which in turn trips the thermal protect circuitry and interrupts the performance. See 'Thermal Protection' on page 13 for more information.

Final Thoughts

Just a few final thoughts before we dive into a little more boring “techy”-type stuff.

Factory Reset

Let’s also talk factory resets. Since settings may be changed via Thump Connect 2, it may be necessary to reset the Thrash212 GO to its factory settings.

There are two kinds of resets:

- **Soft Reset** – Just a simple power cycle will reset all settings that were previously set via the rear panel back to their default settings (except for Bluetooth and linked speakers that are stored within Thrash212 GO).
- **Hard Reset** – A hard reset resets the entire unit to its factory default, including auto-connect and auto-link.

For starters, the loudspeaker needs to be powered on. Then, holding both the pair and link buttons (while either is engaged) clears all paired devices and previously linked speakers.



Be sure to power down any amps and/or powered speakers before resetting Thrash212 GO.



If you use the factory default key combination, you are also wiping the Thrash212 GO’s memory of previously paired devices.

To remedy this, on your phone, tablet or other Bluetooth device, you will need to ‘forget device’ in the Bluetooth settings, then re-pair in order to regain communication and functionality.

Battery Replacement

The Lithium-Ion Battery allows you to use Thrash212 GO without the need to be plugged in or wasting money on expensive batteries.



SAFETY FIRST: Before installing and using this product, please read these instructions carefully. Failure to follow the precautions may result in damage, injury, or even death.

1. WARNING: The battery (battery or batteries or battery pack) shall not be exposed to excessive heat such as sunshine, fire or the like.

2. CAUTION: Danger of explosion if battery is incorrectly replaced. Replace only with the same or equivalent type.

3. No open flame sources, such as lighted candles, should be placed on the apparatus.

WARNING: When installing this product, always respect the safety standard. Do not install the product in any way that is not described in these instructions.

BATTERY / COVER REMOVAL INSTRUCTIONS:

Unplug Thrash212 GO and set it down with the grille side facing down on a soft, flat surface.

Using a flathead or Phillips screwdriver, rotate the two locking tabs counter-clockwise until they unlock and the compartment is ready for removal. The battery compartment is located underneath the power connector. Remove the battery compartment cover and set it aside.

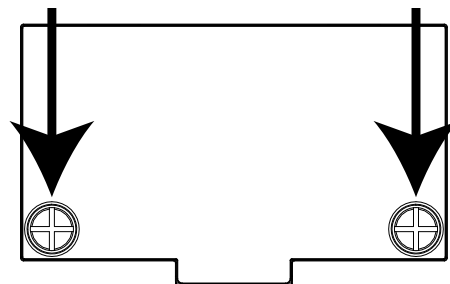

Thrash212 GO: Rear Panel Features continued...

As seen below, the removable battery is surrounded by the dotted line.

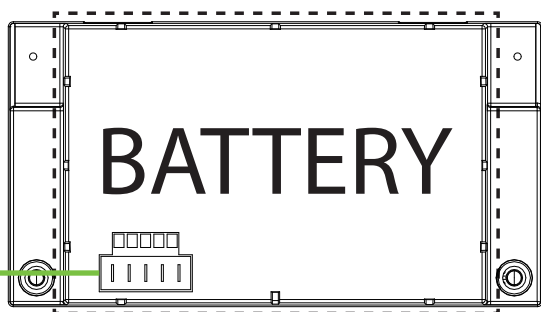

There are finger grips on each side of the battery. Remove the battery from captivity by lifting it straight up to freedom.

BATTERY INSTALLATION INSTRUCTIONS:

Once the battery cover and battery have been removed and set aside, it's time to insert a different one.



NOTE: Do not force the battery into place. There is only one way it fits and there should be no resistance during installation.

As seen in the drawing above, a horizontal power connector is located in the lower-left corner from where the battery was removed. Line up the power connector of the battery with the power connector of Thrash212 GO and press down. Again, this is an easy process; no force is necessary.

Replace the battery cover and lock it to the Thrash212 GO by rotating the two locking tabs clockwise until they lock into place.



When not in use, the spare battery (purchased separately) may be charged by plugging the included wall adapter into the power receptacle of the battery and the other side into a live AC outlet. The battery will also charge while inside a plugged-in Thrash212 GO.

Protection Circuitry

Thrash212 GO employs a built-in limiter for less distortion at peak levels. A dynamic bass response circuit provides optimal low frequency response regardless of overall output level. Additional protection includes automatic thermal shutdown should the amp overheat. However, with Class-D amp technology, which is highly-efficient, this should never be a problem.



The protection circuits are designed to protect it under reasonable and sensible conditions. Should you choose to ignore the warning signs [e.g. excessive distortion], you can still damage the woofer in the loudspeaker by overdriving it past the point of amplifier clipping. Such damage is beyond the scope of the warranty.

Limiting

Let's take a peek under the hood at the titanium high-frequency driver. Compared to other available drivers, these provide a substantially smoother high-frequency response which results in a studio monitor level of accuracy and clarity. Furthermore, these drivers offer an insanely smooth transient response behavior. Yes, we, too, are fans of our own products!

Continuing on, the driver has its own compression circuit which helps protect it from damaging transient peaks. The compressor is designed to be transparent and is not noticeable under normal operating conditions.

Overexcursion Protection

A subsonic filter circuit just prior to the power amplifier prevents ultra-low frequencies from being amplified. Excessive low-frequency energy can damage the woofer by causing it to "bottom out," also known as overexcursion, which is equivalent to a mechanical form of clipping.

Thermal Protection

All amplifiers produce heat. Thrash212 GO is designed to be efficient both electrically and thermally. In the unlikely event of the amplifier overheating, a built-in thermal switch will activate, muting the signal.

When the amplifier has cooled down to a safe operating temperature, the thermal switch resets itself, and the Thrash212 GO resumes normal operation.

If the thermal switch activates, try turning down the level control a notch or two on the mixing console (or via the main volume knob) to avoid overheating the amplifier. Be aware that direct sunlight and/or hot stage lights may be the culprit of an amplifier overheating.

AC Power

Be sure the Thrash212 GO is plugged into an outlet that is able to supply the correct voltage. It will continue to operate at lower voltages, but will not reach full power. Be sure the electrical service can supply enough amperage for all the components connected to it.

We recommend that a stiff (robust) supply of AC power be used because the amplifiers place high current demands on the AC line. The more power that is available on the line, the louder the speaker will play and the more peak output power will be available for a cleaner, punchier bass. A suspected problem of "poor bass performance" is often caused by a weak AC supply to the amplifiers.



Never remove the ground pin on the power cord or any other component of the Thrash212 GO. This is very dangerous.

Care and Maintenance

Your Thrash212 GO will provide many years of reliable service if you follow these guidelines:

- Avoid exposing it to moisture. If it is set up outdoors, be sure it is under cover if rain is expected.
- Avoid exposure to extreme cold (below freezing temperatures). If you must operate in a cold environment, warm up the voice coils slowly by sending a low-level signal through them for about 15 minutes prior to high-power operation.
- Use a dry cloth to clean the cabinet. Only do this when the power is turned off. Avoid getting moisture into any of the openings of the cabinet, particularly where the drivers are located.

Placement



WARNING: Installation should only be done by an experienced technician. Improper installation may result in damage to the equipment, injury or – while highly unlikely – death. Make sure that the Thrash212 GO is installed in a stable and secure way in order to avoid any conditions that may be dangerous for persons or structures.

Thrash212 GO is designed to sit on the floor or stage as the main PA or as monitors. They may also be pole-mounted via the built-in socket on the bottom of the cabinet. Be sure the pole is capable of supporting the weight of the loudspeaker. The T100 is a great tripod option and the SPM200 (unthreaded) or SPM400 (threaded) is a nice choice when using a subwoofer.



Thrash212 GO does not have any fly points and may NOT be flown. NEVER attempt to suspend a Thrash212 GO by its handles.

Check to make sure that the support surface (e.g. floor, etc.) has the necessary mechanical characteristics to support the weight of the loudspeaker(s).

When pole-mounting loudspeakers, be sure that they are stabilized and secured from falling over or being accidentally pushed over. Failure to follow these precautions may result in damage to the equipment, personal injury, or death.

Thrash212 GO may also be laid out horizontally as monitors for the band at a 45° angle (as seen below). It is intended to be used only when the speaker is in its wedge configuration and works best when on a hard work surface, like a stage.

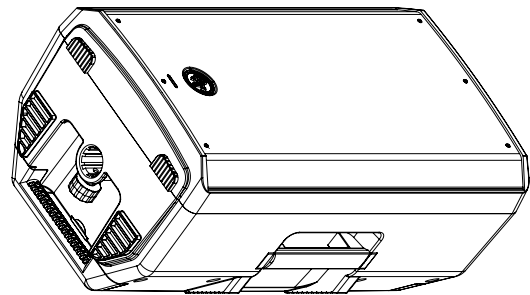

As seen above, the Running Man logo is rotatable for when the loudspeaker is used as a monitor!

As with any powered components, protect them from moisture. Avoid installing the loudspeaker in places exposed to harsh weather conditions. If you are setting them up outdoors, make sure they are under cover if you expect rain.

Room Acoustics

Thrash212 GO is designed to sound fantastic in nearly every application.

But, room acoustics play a crucial role in the overall performance of a sound system. However, the wide high-frequency dispersion of Thrash212 GO helps to minimize the problems that typically arise.

Here are some additional placement tips to help overcome some typical room problems that might arise:

- Placing loudspeakers in the corners of a room increases the low frequency output and can cause the sound to be muddy and indistinct.
- Placing loudspeakers against a wall increases the low frequency output, though not as much as corner placement. However, this is a good way to reinforce the low frequencies, if so desired.
- Avoid placing the speakers directly on a hollow stage floor. A hollow stage can resonate at certain frequencies, causing peaks and dips in the frequency response of the room. It is better to place them on a sturdy stand designed to handle the weight of the loudspeaker.
- Position the loudspeakers so the high-frequency drivers are two to four feet above ear level for the audience (making allowances for an audience that may be standing/dancing in the aisles). High frequencies are highly directional and tend to be absorbed much easier than lower frequencies. By providing direct line-of-sight from the loudspeakers to the audience, you increase the overall brightness and intelligibility of the sound system.
- Highly reverberant rooms, like many gymnasiums and auditoriums, are a nightmare for sound system intelligibility. Multiple reflections off the hard walls, ceiling, and floor play havoc with the sound. Depending on the situation, you may be able to take some steps to minimize the reflections, such as putting carpeting on the floors, closing draperies to cover large glass windows, or hanging tapestries or other materials on the walls to absorb some of the sound.

However, in most cases, these remedies are not possible or practical. So what do you do? Making the sound system louder generally doesn't work because the reflections become louder, too. The best approach is to provide as much direct sound coverage to the audience as possible. The farther away you are from the speaker, the more prominent will be the reflected sound.

Use more speakers strategically placed so they are closer to the back of the audience. If the distance between the front and back speakers is more than about 100 feet, you should use an external delay processor to time-align the sound. (Since sound travels about 1 foot per millisecond, it takes about 1/10 of a second to travel 100 feet.)

Appendix A: Service Information

If you think your Thrash212 GO has a problem, please check out the following troubleshooting tips and do your best to confirm the problem. Visit the Support section of our website (www.mackie.com/support) where you will find lots of useful information such as FAQs and other documentation. You may find the answer to the problem without having to part with your loudspeaker.

Troubleshooting

No power

- Our favorite question: Is it plugged in and/or is the battery charged? Make sure the AC outlet is live [check with a tester or lamp].
- Our next favorite question: Is the power switch on? If not, try turning it on.
- Make sure the line cord is securely seated in the line cord socket and plugged all the way into the AC outlet.
- Is the power LED on the front panel illuminated? If not, make sure the AC outlet is live. If so, refer to "No sound" below.
- The internal AC line fuse may be blown. This is not a user serviceable part. If you suspect the AC line fuse is blown, please see the "Repair" section next.

No sound

- Is the level knob for the input source turned all the way down? Verify that all the volume controls in the system are properly adjusted. Look at the level meter to ensure that the mixer is receiving a signal.
- Is the signal source working? Make sure the connecting cables are in good repair and securely connected at both ends. Make sure the output level control on the mixing console is turned up sufficiently to drive the inputs of the speaker.
- Make sure the mixer does not have a mute on or a processor loop engaged. If you find something like this, make sure the level is turned down before disengaging the offending switch.
- Has it shut down? Make sure there is at least six inches of free space behind each Thrash212 GO.

Poor sound

- Is it loud and distorted? Make sure that you're not overdriving a stage in the signal chain. Verify that all level controls are set properly.
- Is the input connector plugged completely into the jack? Be sure all connections are secure.
- Are there phasing issues? The signal source should only be connected to a single input. For example, do not connect the L/R outputs from a mixer to the Thrash212 GO channel 1 and 2 inputs. Do not use a Y cable to split a phone's signal,

use both outputs of a stereo synth (which sums to mono, anyway), etc.

Noise

- Make sure all connections to the Thrash212 GO are good and sound.
- Make sure none of the signal cables are routed near AC cables, power transformers, or other EMI-inducing devices.
- Is there a light dimmer or other SCR-based device on the same AC circuit as the Thrash212 GO? Use an AC line filter or plug the loudspeaker into a different AC circuit.

Hum

- Try disconnecting the cable connected to the input jack. If the noise disappears, it could be a "ground loop," rather than a problem with the Thrash212 GO. Try some of the following troubleshooting ideas:
 - Use balanced connections throughout your system for the best noise rejection.
 - Whenever possible, plug all the audio equipment's line cords into outlets which share a common ground. The distance between the outlets and the common ground should be as short as possible.

Bluetooth / Linking Issues

- Sometimes a good 'ol fashioned reset works wonders. There are two types, soft and hard. See page 12 for more info on resetting Thrash212 GO.
- Try linking two Thrash212 GO loudspeakers together prior to connecting via Bluetooth.
- Be sure to connect the Bluetooth device to the primary Thrash212 GO loudspeaker.

Other Issues

- Please email or call Technical Support if you are having any other issue not listed here:
 - o mackie.com/support-contact
 - o 1-800-898-3211

Repair

For warranty service, refer to the warranty information on page 20.

Non-warranty service is available at a factory-authorized service center. To locate the nearest service center, visit www.mackie.com/support/service-locator. Service for Thrash212 GOs living outside the United States may be obtained through local dealers or distributors.

If you do not have access to our website, please call our Tech Support department at 1-800-898-3211 (normal business hours, Pacific Time), to explain the problem. They will tell you where the nearest factory-authorized service center is located in your area.

Appendix B: Technical Information

Thrash212 GO Specifications

Acoustic Performance

Frequency Range (-10 dB)	52 Hz – 20 kHz
Frequency Range (-3 dB)	65 Hz – 20 kHz
Horizontal Coverage Angle	90°
Vertical Coverage Angle	60°
Maximum SPL Peak	125 dB
Monitor Angle	45°

Transducers

Low Frequency	12 in / 305 mm with ferrite
High Frequency	1.0 in / 25 mm titanium high-frequency driver

Power Amplifiers

System Power Amplification	
Rated Power	300 watts peak
Low Frequency Power Amplifier	
Rated Power	250 watts peak
Rated THD	< 1%
Cooling	Convection
Design	Class D
High Frequency Power Amplifier	
Rated Power	50 watts peak
Rated THD	< 1%
Cooling	Convection
Design	Class D

Input/Output

Input Type	2x Female XLR & 1/4" Balanced TRS combo jack • Bluetooth
Mic-Line Impedance	7.6 kΩ
1/4" TRS / XLR	1 MΩ balanced / 7.6 kΩ
Output Type	Male XLR Balanced [Thru]
Thru Impedance	600 Ω

Electronic Crossover

Crossover Type	LF Linkwitz-Riley 24 dB / oct, HF Linkwitz-Riley 48 dB / oct
Crossover Frequency	2.4 kHz

Line Input Power

Detachable line cord	100–120V~, 50–60Hz, 75W, input current 2A 220–240V~, 50–60Hz, 75W, input current 1.2A
AC Connector	3-pin IEC 250 VAC, 10 A male
Power Supply Type	Switching Power Supply

Safety Features

Input Protection supply	Peak and RMS limiting, power and amplifier thermal protection
Display LEDs	Front LED, Bluetooth Status, Link Status, Power/Overload, Battery Level

Battery Information

Battery Type	Lithium Ion
Battery Life	Up to 10 hours
Charge Time	5 hours (no signal) 7 hours (with signal)
Capacity	12500 mAh
Nominal Voltage	11.1 V
Watt Hours	138.75Wh
Operating Temperature Range	-10 ~ 40 °C // 14 ~ 104 °F
Charging Temperature Range	-10 ~ 45 °C // 14 ~ 113 °F

Construction Features

Basic Design	Asymmetrical
Enclosure Material	Painted Polypropylene
Enclosure Finish	Black, textured finish
Grille Material	Perforated metal w/weather-resistant coating
Grille Finish	Powder-coated black
Handles	Four

Physical Properties

Height	26.4 in / 669 mm
Width	14.8 in / 375 mm
Depth	12.3 in / 313 mm
Weight	35.9 lb / 16.2 kg

Mounting Methods:

Floor mount or pole mount via the built-in socket on the bottom of the cabinet [Be sure the pole is capable of supporting the weight of the Thrash212 GO].

They are NOT designed to be suspended. The cabinet has no rigging points and is not suitable for rigging. Never attempt to suspend a Thrash212 GO by its handle.

See pages 14–15 for more information.

Options

Thrash212 GO Bag	P/N 2055236
Thrash212 GO Spare Battery	P/N 2056008
T100 Loudspeaker Tripod Stand	P/N 2052464
SPM200 Unthreaded Loudspeaker Pole Mount	P/N 2035170
SPM400 Threaded Loudspeaker Pole Mount	P/N 2051055

In Memory

Dedicated to our sweet Juno. RIP sweet, stinky mama grrrr, we love you!

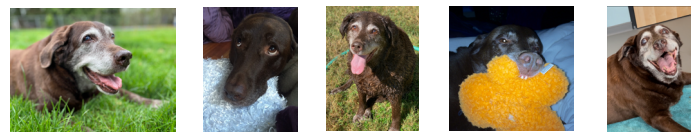

Disclaimer

Since we are always striving to make our products better by incorporating new and improved materials, components, and manufacturing methods, we reserve the right to change these specifications at any time without notice.

The "Running Man" figure is a registered trademark of LOUD Audio, LLC.

All other brand names mentioned are trademarks or registered trademarks of their respective holders, and are hereby acknowledged.

©2023 LOUD Audio, LLC. All Rights Reserved.

Thrash212 GO 12" Battery-Powered Loudspeaker

Thrash212 GO Block Diagram

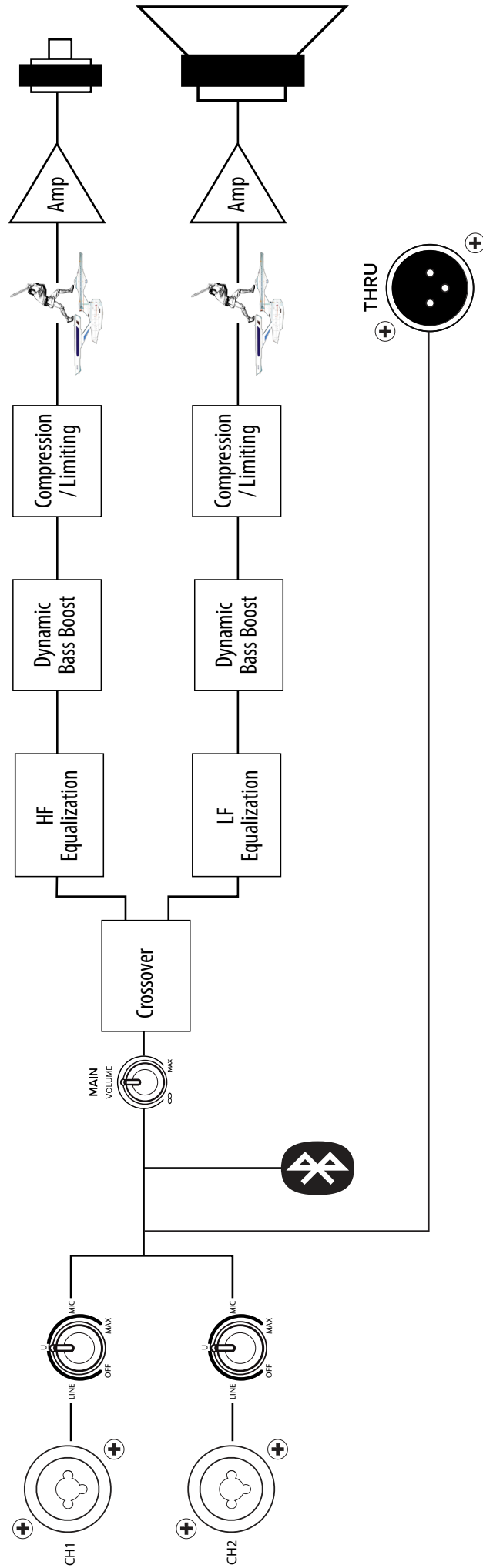

Trash212 GO Dimensions



Limited Warranty

Please keep your sales receipt in a safe place.

This Limited Product Warranty ("Product Warranty") is provided by LOUD Audio, LLC ("LOUD") and is applicable to products purchased in the United States or Canada through a LOUD-authorized reseller or dealer. The Product Warranty will not extend to anyone other than the original purchaser of the product (hereinafter, "Customer," "you" or "your").

For products purchased outside the U.S. or Canada, please visit www.mackie.com to find contact information for your local distributor, and information on any warranty coverage provided by the distributor in your local market.

LOUD warrants to Customer that the product will be free from defects in materials and workmanship under normal use during the Warranty Period. If the product fails to conform to the warranty then LOUD or its authorized service representative will at its option, either repair or replace any such nonconforming product, provided that Customer gives notice of the noncompliance within the Warranty Period to the Company at: www.mackie.com or by calling LOUD technical support at 1.800.898.3211 (toll-free in the U.S. and Canada) during normal business hours Pacific Time, excluding weekends or LOUD holidays. Please retain the original dated sales receipt as evidence of the date of purchase. You will need it to obtain any warranty service.

For full terms and conditions, as well as the specific duration of the Warranty for this product, please visit www.mackie.com.

The Product Warranty, together with your invoice or receipt, and the terms and conditions located at www.mackie.com constitutes the entire agreement, and supersedes any and all prior agreements between LOUD and Customer related to the subject matter hereof. No amendment, modification or waiver of any of the provisions of this Product Warranty will be valid unless set forth in a written instrument signed by the party to be bound thereby.

Need help with the Thrash212 GO?

- Visit www.mackie.com/support to find: FAQs, manuals, addendums, and other documents.
- Email us at: www.mackie.com/support-contact
- Telephone 1-800-898-3211 to speak with one of our splendid technical support chaps (Monday through Friday, normal business hours, Pacific Time).



**19820 North Creek Parkway #201
Bothell, WA 98011 • USA
Phone: 425.487.4333
Toll-free: 800.898.3211
Fax: 425.487.4337
www.mackie.com**
