

TORK®

Xpressnap®
Counter
Napkin Dispenser

N4

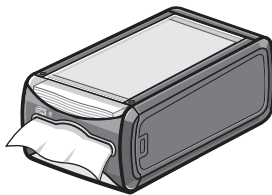

Signature
Design

Loading Instructions

Instrucciones de Recarga

Instructions de Remplissage

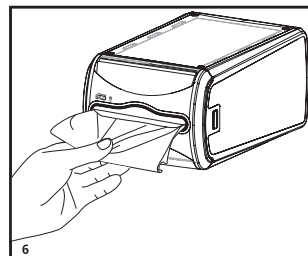
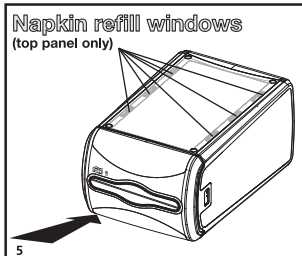
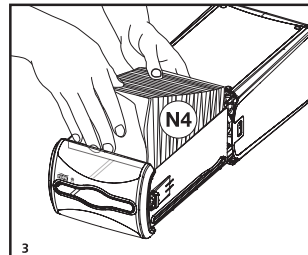
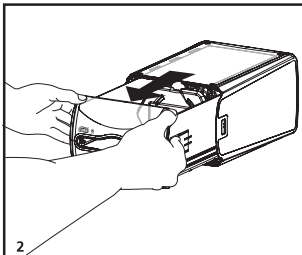
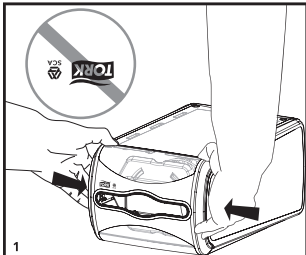

Cleaning Instructions

Instrucciones de Limpieza

Instructions de Nettoyage

Cleaning: Use mild cleaners. Wipe with cloth using soap and water. Do not use abrasives. Dispenser is not dishwasher safe. Dispenser's mouth can be disassembled for cleaning, if necessary.

Limpieza: use limpiadores suaves. Frote con un paño, con agua y jabón. No use abrasivos. El dispensador no es apto para lavar en máquinas lavavajillas. La boca del dispensador puede desmontarse para la limpieza, si fuera necesario.

Nettoyage: Utiliser des produits nettoyants doux. Essuyer avec un tissu mouillé d'eau et de savon. Ne pas utiliser de produit abrasif. Le distributeur n'est pas conçu pour aller au lave-vaisselle. Si nécessaire, le bec du distributeur peut être démonté pour être nettoyé.

Manufactured by SCA,
SE-405 03 Göteborg, Sweden
www.sca-tork.com
Made in United States



TORK®

Xpressnap®
Counter
Napkin Dispenser

N4

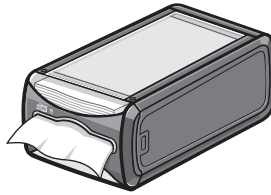

Signature
Design

AD-a-Glance® Feature

Espacio Publicitario Para AD-a-Glance

Fonction AD-a-Glance

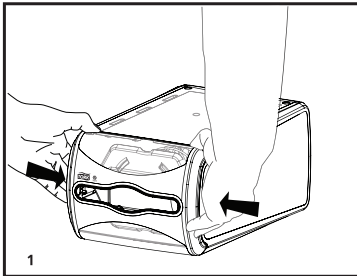

1

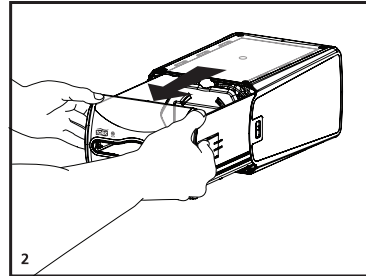

2

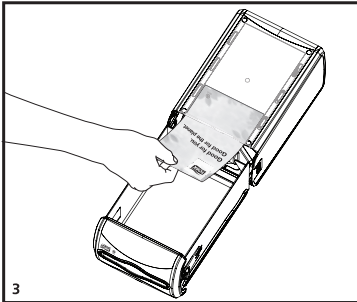

3

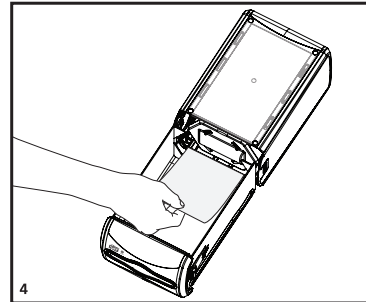

4

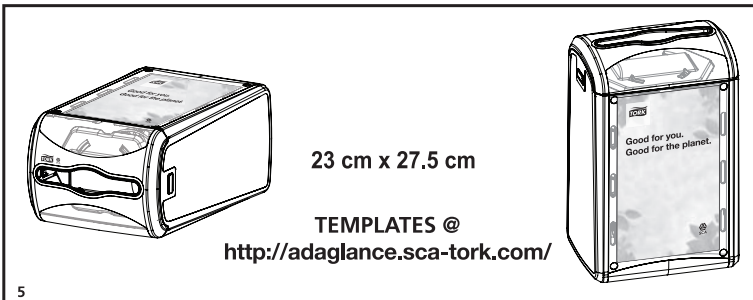

5

23 cm x 27.5 cm

TEMPLATES @
<http://adaglance.sca-tork.com/>

Manufactured by SCA,
SE-405 03 Göteborg, Sweden
www.sca-tork.com
Made in United States

