

DO NOT PRINT THIS PAGE

REVISIONS			
REV.	DESCRIPTION	ECN	DATE
A	RELEASED TO PRODUCTION	E000358	2015-08-18

REFERENCE ONLY, PLEASE USE AI / EPS FOR PRINTING



PANTONE
CYAN



PANTONE
MAGENTA



PANTONE
YELLOW

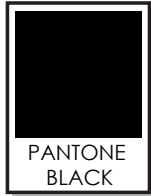

PANTONE
BLACK

SCA TEMPLATE SHORT

PROPRIETARY AND CONFIDENTIAL THE INFORMATION CONTAINED IN THIS DRAWING IS THE SOLE PROPERTY OF SCA GLOBAL HYGIENE CATEGORY. ANY REPRODUCTION IN PART OR AS A WHOLE WITHOUT WRITTEN PERMISSION IS PROHIBITED.		PROJECTION FIRST ANGLE 		
DRAWN BY ALTEN		DATE 2015-02-25	DESCRIPTION ARTWORK, INSTRUCTION MANUAL EU	
UNLESS OTHERWISE SPECIFIED DIMENSIONS ARE IN MILLIMETERS [INCHES] AND TOLERANCES FOR LINEAR: $.X = \pm .79$ [.031] ANGULAR: $\pm 2^\circ$		PREVIOUS PART NUMBER N/A		STATE RELEASED
REFER TO ECN FOR APPROVALS AND DATES		SIZE N/A	SCALE 1:1	SHEET N/A
		DWG NO. 0013000		REVISION A

Tork Foam Soap Dispenser with Intuition™ Sensor

Image
Design

S4

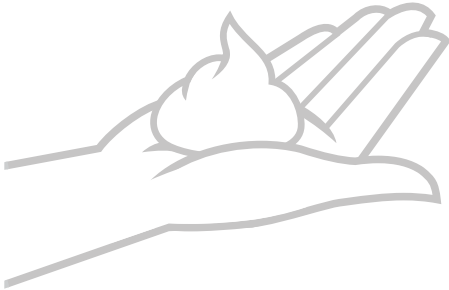
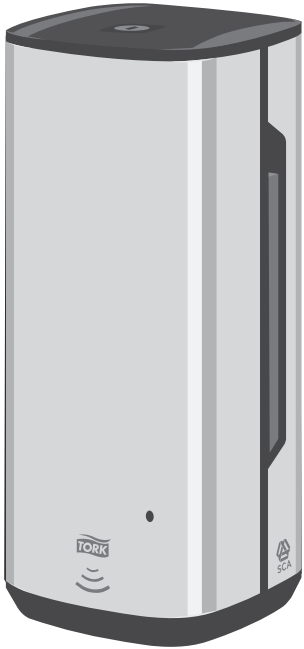

www.sca-tork.com



Tork Foam Soap Dispenser

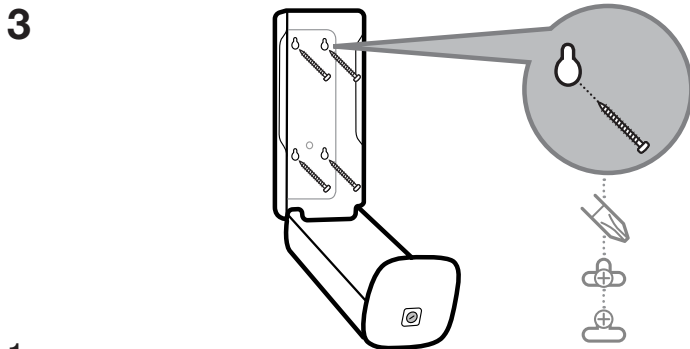
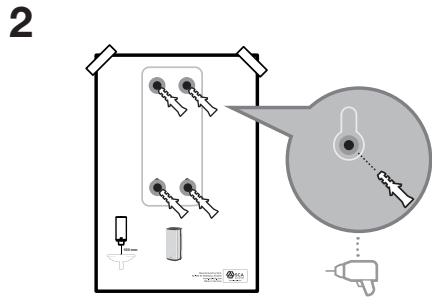
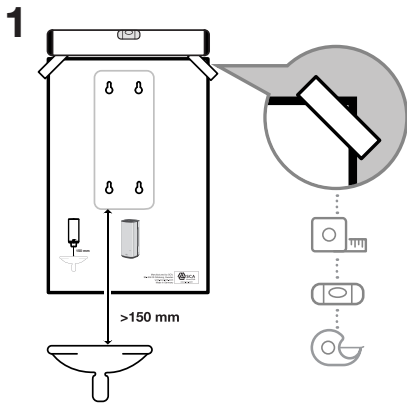
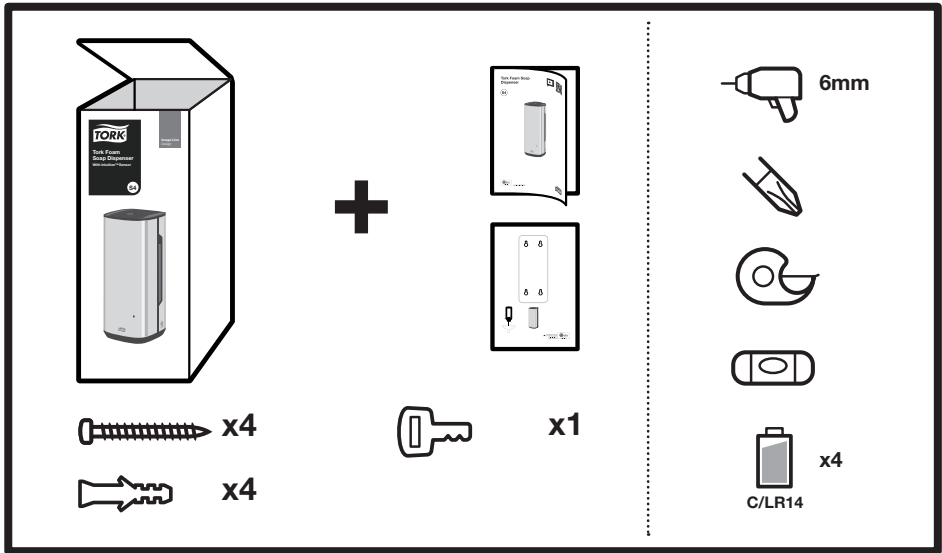

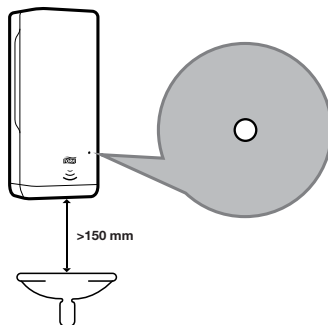
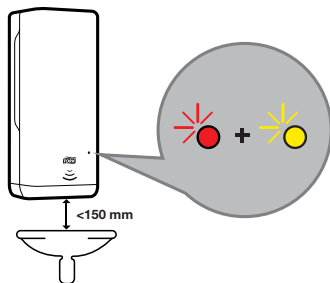
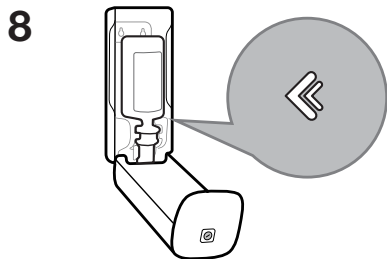
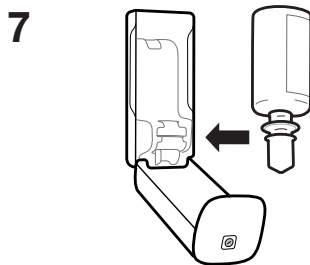
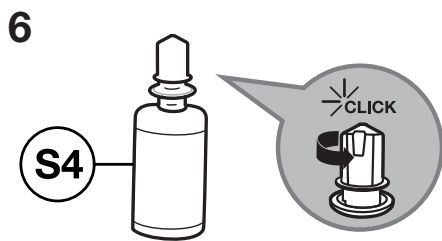
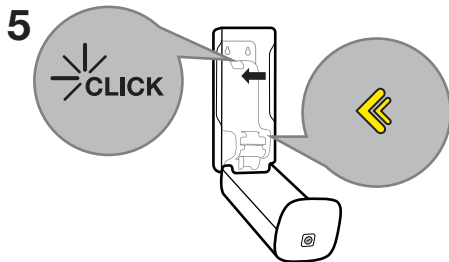
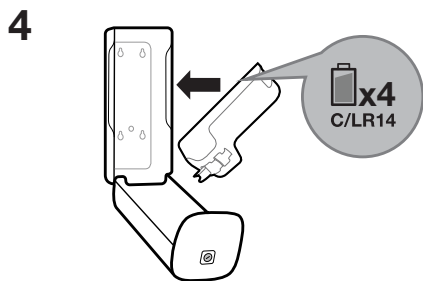

Tork Foam Soap Dispenser

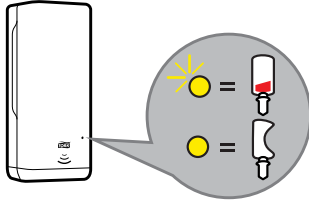

1

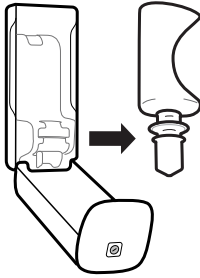

2

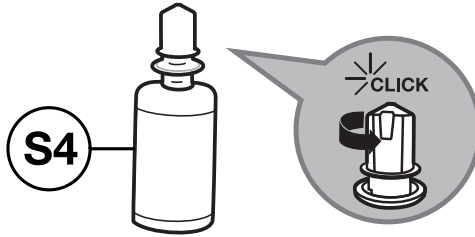

3

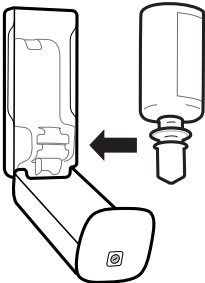

4

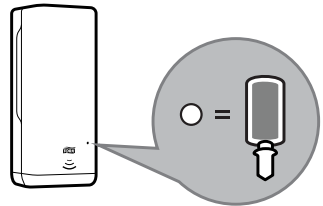

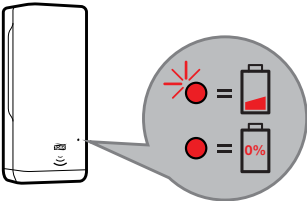

1

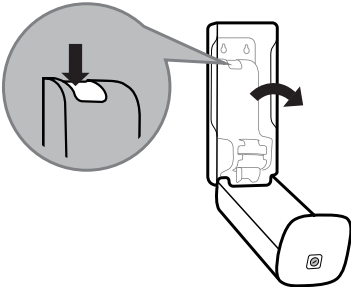

2

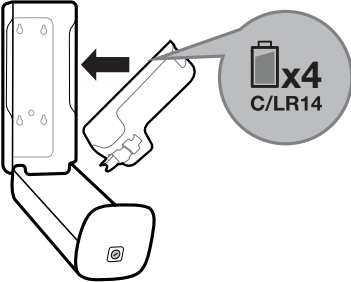

3

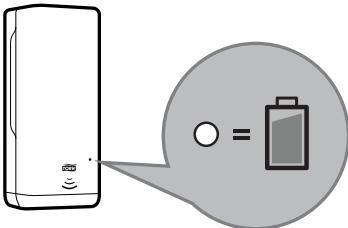

Tork Foam Soap Dispenser

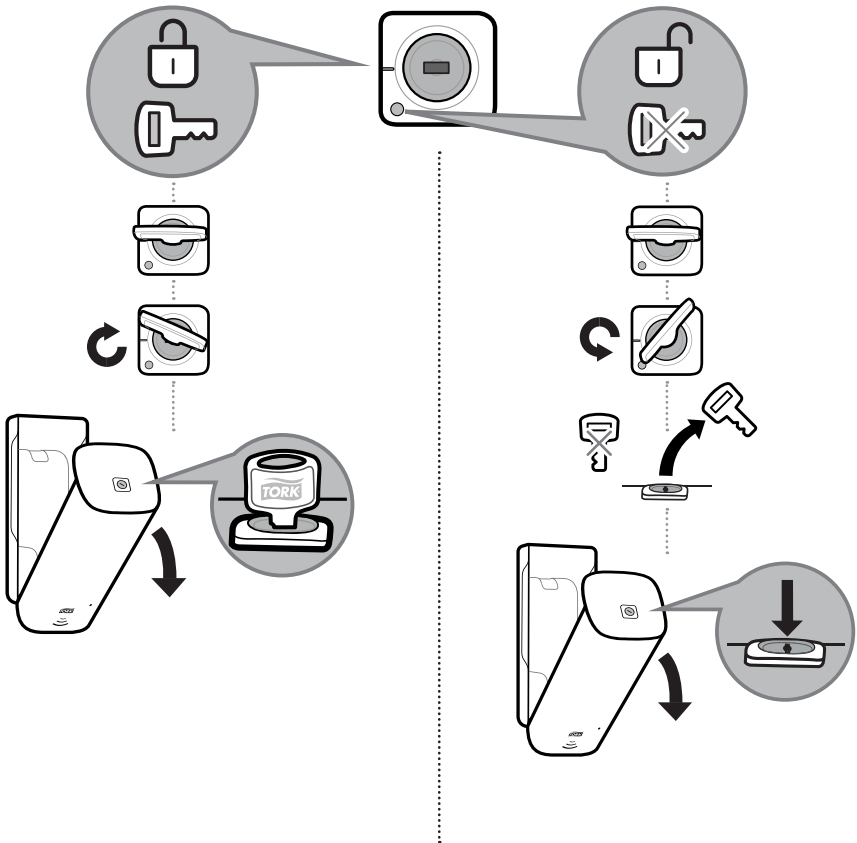

Warnings

- Children should not be allowed to play with the appliance
- The maximum and minimum ambient temperatures for correct operation are 0 to 50 degrees Celsius (32 to 122 degrees Fahrenheit)
- This dispenser is not suitable for installation outdoors or in wet environments. It is not water-resistant
- Operating sound level of the dispenser is less than 70dBa

Disposal

- Damaged or malfunctioning product should be disposed of immediately to avoid potential of injury
- Products should be disposed of in accordance with applicable regulations

Cleaning instructions

- Please take necessary precautions during maintenance operations. Clean dispenser as needed. Wipe to clean using a soft, lint free towel. Use water and mild detergent (exterior surfaces only)

European community design registration RCD 002601922



Manufactured by SCA
SE-405 03 Göteborg, Sweden
www.sca-tork.com
Made in Poland