

Unità maniglia standard, senza controllo fusibili, per grandezza costruttiva NH3, accessori per sezionatori sottocarico a fusibili 3NP1



Versione

Marca del prodotto

SETRON

Certificati

[General Product Approval](#)

[Declaration of Conformity](#)

[Miscellaneous](#)



EG-Konf.

Ulteriori informazioni

Information- and Downloadcenter (Cataloghi, Opuscoli,...)

<http://www.siemens.com/lowvoltage/catalogs>

Industry Mall (sistema di ordinazione Online)

<https://mall.industry.siemens.com/mall/it/it/Catalog/product?mlfb=3NP1963-1GA00>

Service&Support (Manuali, Certificati, Caratteristiche, FAQ, ...)

<https://support.industry.siemens.com/cs/ww/it/ps/3NP1963-1GA00>

Banca dati immagini (foto prodotto, disegni dimensionali 2D, modelli 3D, schemi delle connessioni, ...)

http://www.automation.siemens.com/bilddb/cax_en.aspx?mlfb=3NP1963-1GA00

CAX-Online-Generator

<http://www.siemens.com/cax>

Tender specifications

<http://www.siemens.com/specifications>

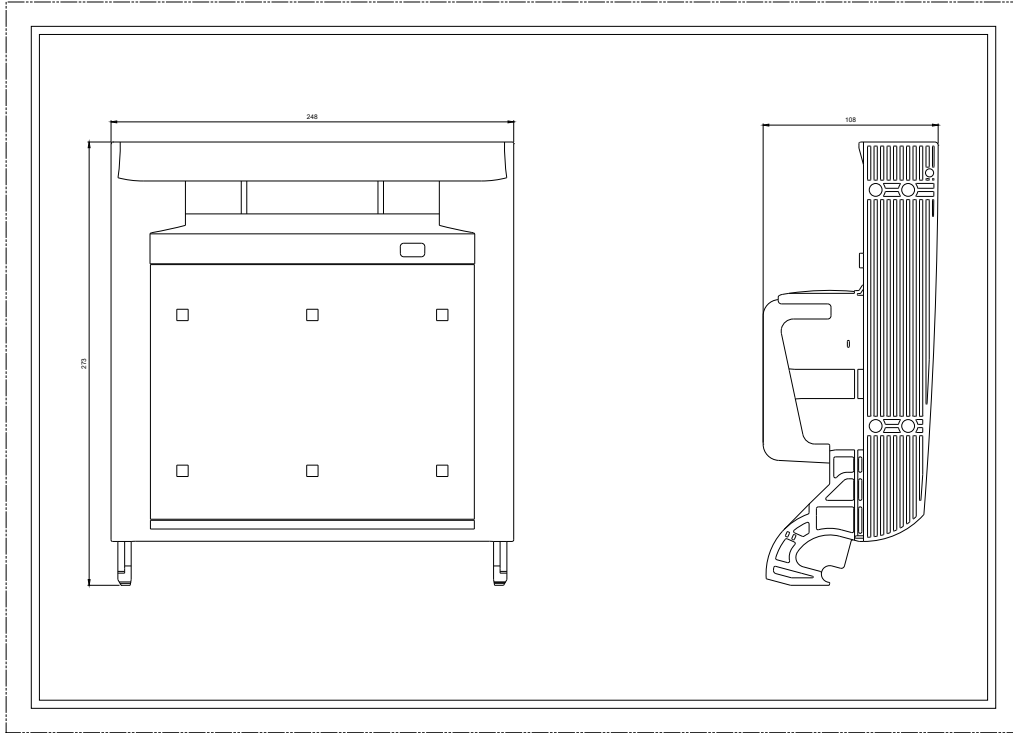



-CB

