



SAUTER JCT 100

V. 1.0 09/2023

Manual

Congratulations on your purchase of a digital coating thickness gauge from SAUTER. We hope you enjoy your quality-measuring device with its wide range of functions. If you have any questions, requests or suggestions, please do not hesitate to contact us.

Table of content:

1	Introduction	4
2	Check before Use	4
3	Intended use	4
4	Warnings / Safety instructions	4
5	Scope of delivery	5
6	Technical data	5
7	Controls	7
8	LCD Display	7
8.1	Menu Icons	7
8.2	Main Interface	8
8.3	Single point	8
8.4	Multi point	8
9	Operating Instructions	9
9.1	Power on/off	9
9.2	Measurement	9
9.3	Menu	10
9.3.1	Auto Rotate Screen	10
9.3.2	Length Unit	10
9.3.3	Probe Mode	10
9.3.4	Data Storage Location.....	11
9.3.5	Continuous Measurement	11
9.3.6	Upper Limit	11
9.3.7	Lower Limit	11
9.3.8	LED Alarm	12
9.3.9	Voice Broadcast	12
9.3.10	Calibration Mode	12
9.3.11	Language	12
9.3.12	Buzzer	12
9.3.13	Backlight Brightness.....	13
9.3.14	Bluetooth	13
9.3.15	Restore Factory Settings.....	13

9.4	Calculated Values	13
9.5	Quick Test Mode	13
9.5.1	Single Point	14
9.5.2	Multi-Point.....	14
9.6	Calibration	14
9.6.1	Zero-Point Calibration.....	15
9.6.2	Two-Point Calibration	15
10	Certificate of Compliance	16

1 Introduction

Read these operating instructions carefully before commissioning, even if you already have experience with SAUTER measuring devices. SAUTER offers the software and accessories as an option to make the measuring device more versatile in use. Please enquire with SAUTER or your SAUTER dealer or visit our website at www.sauter.eu.

2 Check before Use

After receiving the unit, check in advance whether there has been any transport damage, whether the outer packaging, the plastic housing, other parts or even the unit itself has been damaged. If any damage is apparent, please notify the specialist dealer or manufacturer immediately.

3 Intended use

JCT 100 is an upgraded high-performance coating thickness gauge that can measure coating thickness on both ferrous and non-ferrous matrixes. This device has features of high precision, stable and reliable performance and non-destructive measurement, etc. It has functions such as automobile mode, voice broadcast, Bluetooth APP, LED flashlight. It is a necessary device for automobile manufacturing, sales, evaluation, metal processing, painting, inspection and other industries. It is widely used in manufacturing, metal processing, aeronautics and space, shipping, bullet trains, scientific research, quality supervision, and other fields.

The product is based on the principles of electromagnetic induction and eddy current measurement.

The principle of electromagnetic induction measurement is to measure the coating thickness according to the size of the magnetic flux flowing from the sensor through the non-ferrous magnetic coating into the ferromagnetic matrix. The symbol is Fe. It can measure non-conductive or conductive coatings on magnetically permeable metals such as iron and steel (for example: galvanized steel sheet).

The principle of eddy current measurement is to measure the coating thickness according to the difference in the eddy current formed by an AC magnetic field on a non-magnetic metal matrix (such as aluminum). The symbol is NFe. It can measure non-conductive coatings on non-magnetic metal materials such as aluminum and copper. The matrix must be metal, and the coating cannot conduct electricity.

4 Warnings / Safety instructions

- Initialization self-test is needed for the gauge when it is powered on. When turning on the gauge, please do not put the sensor close to any metal objects, otherwise the gauge will be unusable.
- Please keep the sensor clean and in good condition to avoid dust, oil and other factors affecting the measurement accuracy.
- Do not use or store the gauge in high temperature, high humidity, flammable, explosive and strong magnetic field environments.

- Clean the gauge casing with a soft cloth and mild detergent. Do not use abrasives or solvents to avoid damage to the gauge.
- Do not disassemble or modify the gauge.
- When the LCD displays the low battery symbol " ", charge the product in time.
- In order to prevent fire, when using the USB interface for charging or data communication, please use the original USB cable and disconnect it in time after use.
- Do not irradiate the flashlight at eyes.
- When using the Bluetooth communication function, the distance between the host and the mobile terminal device should be less than 10 meters and there should be no obstacles or metal shielding objects in between.
- The standard coating thickness sheets are high-precision accessories that are related to the accuracy of the gauge and need to be preserved properly to prevent scratches, corrosion, bending and deformation of the surface.
- The metal matrixes also need to be preserved properly to prevent scratches, rust, oxidation and deformation of the surface.
- If other failures occur, select "Restore factory settings" in the menu.

5 Scope of delivery

- Coating thickness gauge
- User manual
- Standard coating thickness sheets
- Ferrous matrix
- Non-ferrous matrix
- Sensor protective cover
- Hand strap
- USB cable
- 3.7V 4.81Wh rechargeable lithium battery

6 Technical data

Function	Area	Resolution	Description
Range	0~2000µm 0~78.7mil		
Resolution	0~99.9µm	0.1µm	
	100~2000µm	1µm	
	0~4.99mil	0.01mil	
	5.0~78.7mil	0.1mil	
Accuracy	±(2%H+2) µm		
	±(2%H+0.08)mil		
Bluetooth APP	System requirements		

Searching time	5 min	If there is no connection for 5 minutes, the Bluetooth function will be automatically turned off.
Transmission distance	≥10m	
Probe measuring force	0.3~1.5N	Probe measuring force range
Display	Color display	2" color TFT screen
Auto rotatable screen	According to the built-in gravity sensor	4 directions: 0°, 90°, 180° and 270°
Unit conversion	µm/mil	Metric/imperial unit conversion
LED alarm	The LED lights up in the corresponding color when the value exceeds the set range for alarm.	
Audio alarm	When measuring, alarming and pressing buttons, there will be corresponding prompt sounds.	The buzzer must be turned on.
Limit setting	0~2000µm	
Measurement modes	Single/continuous	
Statistical measurement	MAX/MIN/AVG	
Matrix identification modes	Auto/manual	
Voice broadcast	Voice broadcast for measured values	The voice broadcast function must be turned on.
Flashlight	Easy to use in dark environments	
USB communication	Upper computer communication	Export stored data via the upper computer
Data storage	3300 data (55 groups * 60)	
Backlight brightness	5 levels	
Auto power off	5 minutes	
Low battery indication	Low battery indication at 3.4V±0.2V	
Power	3.7V 1300mAh lithium battery	
Operating environment	0~40°C ≤80%RH	
Storage environment	-20~60°C ≤75%RH	

7 Controls



1	LED alarming light
2	LCD
3	Power/Flashlight
4	Confirm/menu
5	Repeat/delete
6	Down/automobile mode
7	Up/histogram
8	Sensor
9	Hand strap buckle
10	USB/charging interface
11	Flashlight
12	Loudspeaker

8 LCD Display

8.1 Menu Icons

	Auto rotate screen		Units		Probe modes
	Storage location		Measurement modes		Upper limit
	Lower limit		LED alarm		Voice broadcast
	Calibration modes		Languages		Buzzer
	Backlight brightness		Bluetooth communication		Restore factory settings

Note: When the icon color becomes white, users can adjust the setting items. When the icon is brown, users can only browse the setting items.

8.2 Main Interface

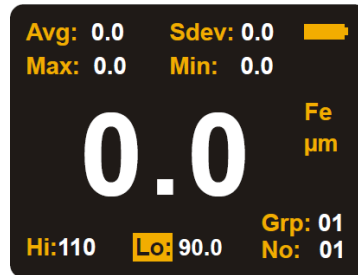

8.3 Single point

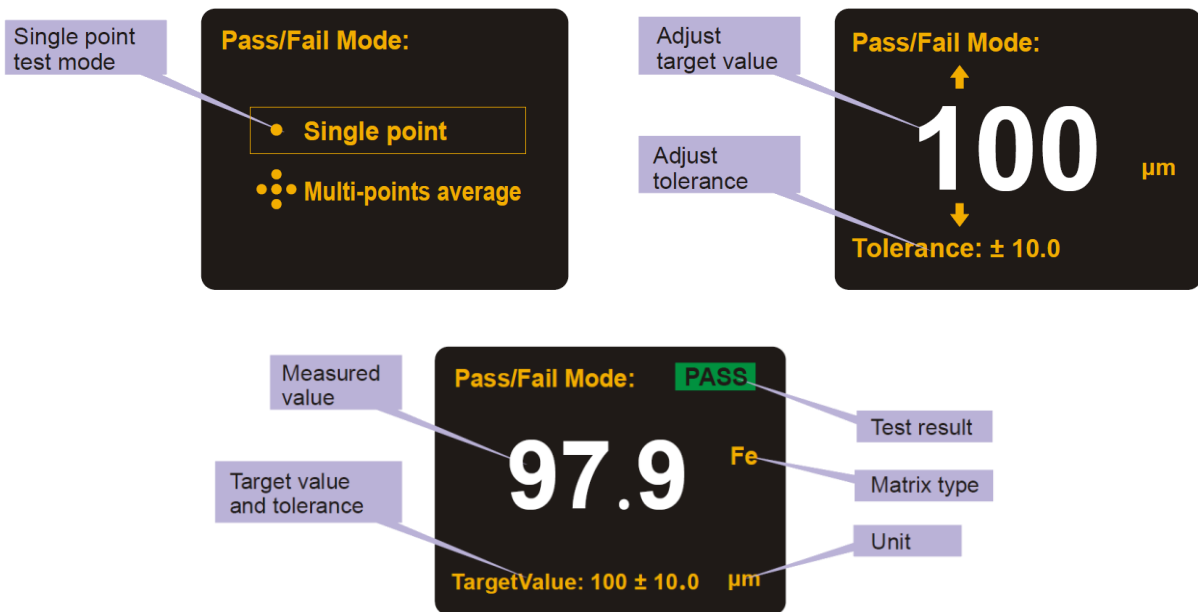

8.4 Multi point

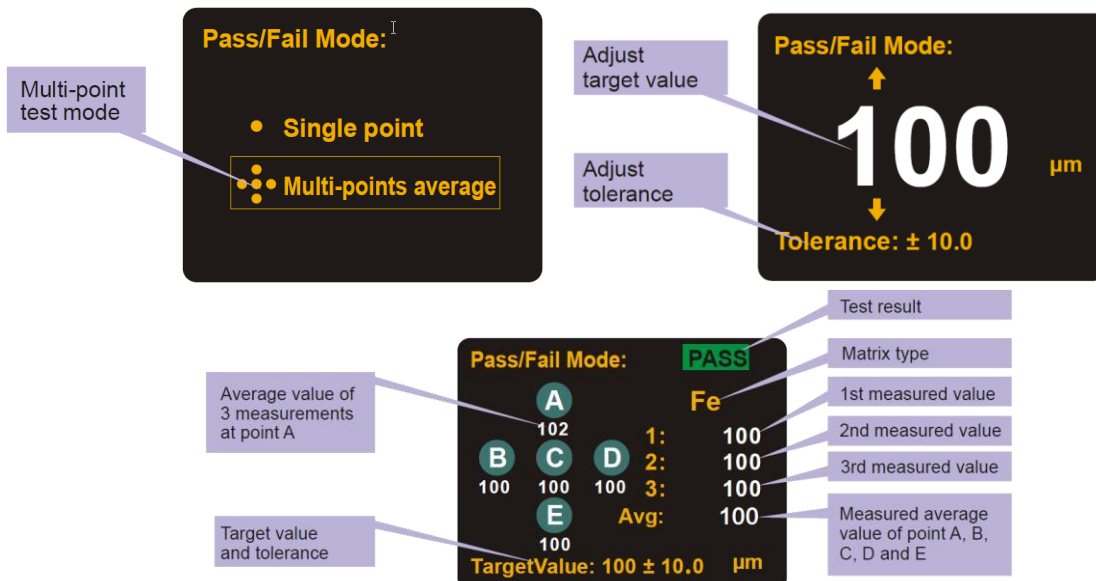

9 Operating Instructions

9.1 Power on/off

Long press  to turn on/off the gauge.

9.2 Measurement

Note: Keep the probe away from metal objects before turning on the product.

- Long press  to power on. It will enter the main interface after initialization
- If the product has not been used for a long time or the operating environment has changed, a two-point calibration is required before use
- First, press the probe vertically on the object to be measured, and the value displayed on the LCD at this time is the estimated value of the coating thickness
- Refer to this estimated value, and select a standard coating thickness sheet closest to this value from the accessories to prepare for two-point calibration
- A matrix with thickness or material close to the measured object and without coating should be selected as the calibration matrix as far as possible. When the above-mentioned matrix is not found, the standard matrix in the accessories can be selected as the calibration matrix (due to differences in material and thickness, the measurement results may be biased)
- Please refer to the calibration chapter for the two-point calibration method
- After the two-point calibration is completed and verified repeatedly, the coating thickness of the object can be measured
- When measuring, select 3 to 5 measuring points on the surface of the measured object evenly, measure 5 times for each point, and take the average value of the 5 times as the indicating value of the point.
- After the indicating values of the 3 to 5 measuring points are measured, the average of the values should be taken as the reference value of the object coating thickness

Note:







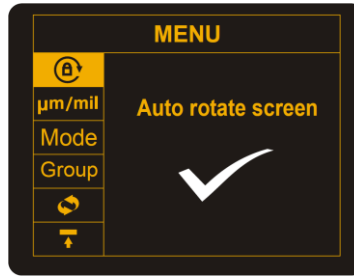

- Hold the gauge perpendicular to the object to be measured, and lightly press the gauge sensor against the object surface for measurement. It is necessary to keep the sensor in close contact with the object surface.
- When the measured indicating value is greater than 2000 μm , the screen displays OL to indicate over range.
- When the measured indicating value is greater than 2200 μm , the gauge will not respond.

9.3 Menu

In the main interface, short press  to open the menu:









9.3.1 Auto Rotate Screen







In the menu, press  or  to select the auto rotate screen icon , and then short press  to enter its setting interface. Press  or  to select to turn on/off the auto rotate function, and short press  to confirm or  to exit.

Note: The gauge has a built-in gravity sensor, which is convenient for users to read the screen content from multiple angles (0°, 90°, 180° and 270°). When the auto rotate function is turned off, the icon  is displayed in the upper right corner of the screen.

9.3.2 Length Unit







In the menu, press  or  to select the length unit icon $\mu\text{m}/\text{mil}$, and then short press  to enter its setting interface. Press  or  to select μm or mil , and short press  to confirm or to exit.

9.3.3 Probe Mode

In the menu, press  or  to select the probe mode icon Mode, and then short press  to enter its setting interface. Press  or  to select automatic/ NFe/Fe mode, and short press  to confirm or to exit.









Automatic mode: In this mode, the matrix type of the measured object (Fe or NFe) will be automatically identified. The sensor will enter a corresponding operating mode according to the matrix type. Fe mode: The sensor will enter the electromagnetic induction operating mode. NFe mode: The sensor will enter the eddy current operating mode.

9.3.4 Data Storage Location

In the menu, press  or  to select the data storage location icon Group, and then short press  to enter its setting interface. Press  or  to select the group number, and short press  to confirm or to exit.









Note: There are 55 groups, and for each group, 60 data can be stored.

9.3.5 Continuous Measurement

In the menu, press  or  to select the continuous measurement icon , and then short press  to enter its setting interface. Press  or  to select to turn on/off the continuous measurement mode, and short press  to confirm or  to exit.









Note: When this mode is turned on, the product will continue to measure until it is turned off.

9.3.6 Upper Limit

In the menu, press  or  to select the upper limit icon , and then short press  to enter its setting interface. Short press  or  to add/subtract 1 to the single digit of the upper limit, and long press to add/subtract 1 to the tens digit. Short press  to confirm or  to exit.

Note: When the measured value is higher than the upper limit and the LED alarm is turned on, the LED light flashes yellow.









9.3.7 Lower Limit

In the menu, press  or  to select the lower limit icon , and then short press  to enter its setting interface. Short press  or  to add/subtract 1 to the single digit of the lower limit, and long press to add/subtract 1 to the tens digit. Short press  to confirm or  to exit.









Note: When the measured value is lower than the lower limit and the LED alarm is turned on, the LED light flashes red.

When the measured value is between the upper limit and the lower limit and the LED alarm is turned on, the LED light flashes green.









9.3.8 LED Alarm

In the menu, press  or  to select the LED alarm icon  , and then short press  to enter its setting interface. Press  or  to select to turn on/off the LED alarm, and short press  to confirm or  to exit.

9.3.9 Voice Broadcast









In the menu, press  or  to select the voice broadcast icon  , and then short press  to enter its setting interface. Press  or  to select to turn on/off the voice broadcast function, and short press  to confirm or  to exit.

9.3.10 Calibration Mode









In the menu, press  or  to select the calibration mode icon  , and then short press  to enter its setting interface. Press  or  to select a calibration mode (single or two-point), and short press  to confirm or  to exit.

Note: The two-point calibration mode is more commonly used than the single-point mode.

9.3.11 Language









In the menu, press  or  to select the language selection icon  , and then short press  to enter its setting interface. Press  or  to select English or Chinese, and short press to confirm  or  to exit.

9.3.12 Buzzer









In the menu, press  or  to select the buzzer icon  , and then short press  to enter its setting interface. Press  or  to select to turn on/off the buzzer, and short press  to confirm or  to exit.

When this function is turned on and the gauge gets the measured value in the normal measurement mode, the buzzer will beep.

9.3.13 Backlight Brightness







In the menu, press  or  to select the backlight brightness icon  , and then short press  to enter its setting interface. Press  or  to adjust the brightness, and short press  to confirm or  to exit.

9.3.14 Bluetooth

In the menu, press  or  to select the Bluetooth icon  , and then short press  to enter its setting interface. Press  or  to select to turn on/off the Bluetooth, and short press  to confirm or  to exit.

Note: If there is no connection for 5 minutes, the Bluetooth function will be automatically turned off.

9.3.15 Restore Factory Settings

In the menu, press  or  to select the restore factory settings icon  , and then short press  to enter its setting interface. Press  or  to select to turn on/off the restore factory settings function, and short press  to confirm or to exit.





9.4 Calculated Values

Four values will be automatically calculated and displayed at the top of the screen:

Avg, Min, Max, Sdev. Long press  for 2 seconds in the main interface to clear the current calculated values.







Note: All the stored data will be cleared if users perform the above operation.

9.5 Quick Test Mode









In the main interface, long press  to enter the quick test mode. Press  or  to select single point test or multi-point test, and short press  to confirm or  to exit.

Note: The quick test mode is mainly used in the measurement of coating thickness of automobiles and other industrial products.

9.5.1 Single Point

- Press  or  to set the target thickness value, and then press  to confirm
- Press  or  to set the tolerance, and short press to enter the single point quick test mode;
- Measure the coating thickness of the measured object;
- The screen will immediately display the measured value and the test result ("PASS" or "FAIL");
- Short press  to return or long press  to exit the single point quick test mode.



9.5.2 Multi-Point

- Press  or  to set the target thickness value, and then press  to confirm;
- Press  or  to set the tolerance, and short press  to enter the multi-point quick test mode;
- Measure the coating thickness of the measured object. Take 3 measurements near the same position and
- the gauge will calculate the average of the 3 times as the value of point A;
- Change a position and take 3 measurements near the new position. The gauge will calculate the average of
- the 3 times as the value of point B;
- The measurement methods of points C, D and E are the same as above;
- After the measurement is completed, the screen immediately displays the average value of these 5 points
- and the test result ("PASS" or "FAIL");
- Short press  to return or long press  to exit the multi-point quick test mode.

9.6 Calibration

In the main interface, long press  to enter the selected calibration mode.

Note: The selected calibration mode depends on the setting in chapter 9.3.10



Calibration modes	Icons	Description
Zero-point calibration		Place the sensor on an uncoated metal matrix
Two-point calibration		The standard coating thickness sheet and uncoated matrix are stacked together for calibration, and more accurate measurement results can be got.

9.6.1 Zero-Point Calibration

- Place the gauge vertically on the uncoated matrix, as shown in below picture
- Pick up the gauge after 2 seconds, the screen displays the value 0.0, as shown in Figure 2, and the gauge automatically returns to the main interface;
- The zero-point calibration completed.



9.6.2 Two-Point Calibration

- Stack the standard coating thickness sheet (take 500μm as an example) and uncoated matrix together for calibration, as shown in Figure 1
- Pick up the gauge after 2 seconds, and the measured value shows on the screen, as shown in Figure 2
- Press  or  to adjust the measured value to make it the same as the thickness value of the standard coating thickness sheet, as shown in Figure 3;
- Press  to confirm or press to cancel the calibration;
- Place the gauge vertically on the uncoated matrix, as shown in Figure 4;
- Pick up the gauge after 2 seconds, the screen displays the value 0.0, as shown in Figure 5, and the gauge automatically returns to the main interface;
- The two-point calibration completed.

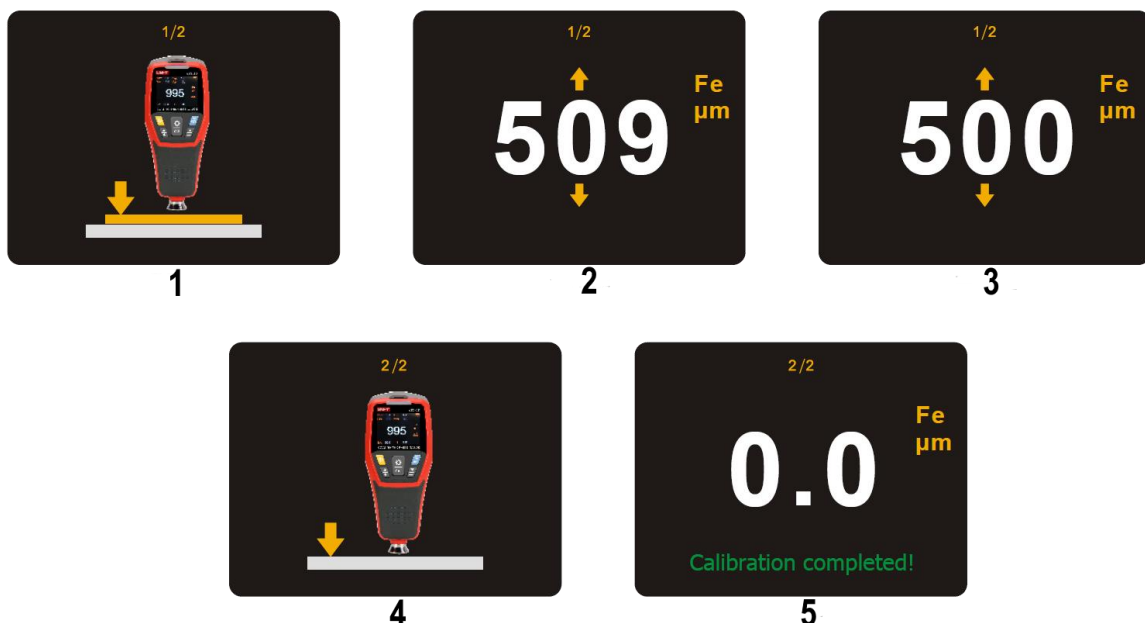

10 Certificate of Compliance

To have a look at the CE Declaration of Conformity, please click onto the following link:
<https://www.kern-sohn.com/shop/de/Downloads>