

Three Phase Rectifier Bridge

$$I_{dAV} = 35 \text{ A}$$

$$V_{RRM} = 800-1800 \text{ V}$$

V_{RSM} V	V_{RRM} V	Type
900	800	VUO 36-08NO8
1300	1200	VUO 36-12NO8
1500	1400	VUO 36-14NO8
1700	1600	VUO 36-16NO8
1900	1800	VUO 36-18NO8

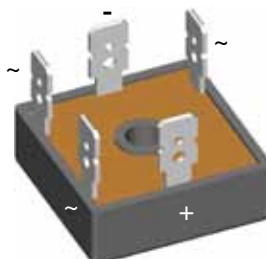
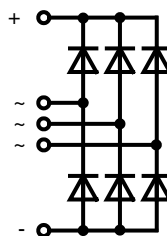

Symbol	Conditions	Maximum Ratings	
I_{dAV}	$T_C = 85^\circ\text{C}$, module	27	A
I_{dAVM}	$T_C = 62^\circ\text{C}$, module	35	A
I_{FSM}	$T_{VJ} = 45^\circ\text{C}$; $t = 10 \text{ ms}$ (50 Hz)	550	A
	$V_R = 0$; $t = 8.3 \text{ ms}$ (60 Hz)	600	A
	$T_{VJ} = T_{VJM}$; $t = 10 \text{ ms}$ (50 Hz)	500	A
	$V_R = 0$; $t = 8.3 \text{ ms}$ (60 Hz)	550	A
I^2t	$T_{VJ} = 45^\circ\text{C}$; $t = 10 \text{ ms}$ (50 Hz)	1520	A ² s
	$V_R = 0$; $t = 8.3 \text{ ms}$ (60 Hz)	1520	A ² s
	$T_{VJ} = T_{VJM}$; $t = 10 \text{ ms}$ (50 Hz)	1250	A ² s
	$V_R = 0$; $t = 8.3 \text{ ms}$ (60 Hz)	1250	A ² s
T_{VJ}		-40...+150	°C
T_{VJM}		150	°C
T_{stg}		-40...+150	°C
V_{ISOL}	50/60 Hz, RMS $t = 1 \text{ min}$	2500	V~
	$I_{ISOL} \leq 1 \text{ mA}$ $t = 1 \text{ s}$	3000	V~
M_d	Mounting torque (M5) (10-32 UNF)	2 ±10%	Nm
		18 ±10%	lb.in.
Weight	Typ.	22	g

Features

- Package with 1/4" fast-on terminals
- Isolation voltage 3000 V~
- Planar passivated chips
- Blocking voltage up to 1800 V
- Low forward voltage drop
- UL registered E 72873

Applications

- Supplies for DC power equipment
- Input rectifiers for PWM inverter
- Battery DC power supplies
- Field supply for DC motors

Advantages

- Easy to mount with one screw
- Space and weight savings
- Improved temperature & power cycling

Dimensions in mm (1 mm = 0.0394")

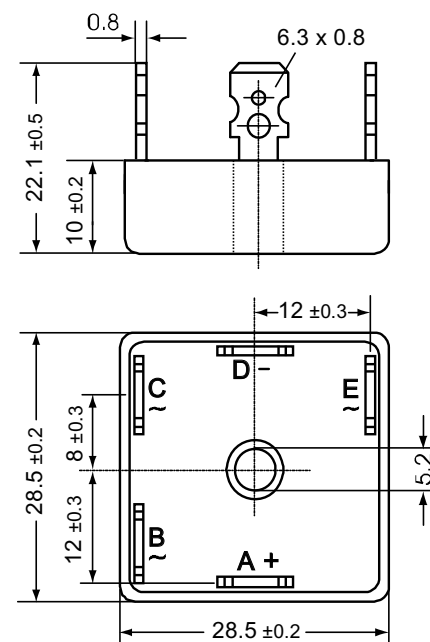

Symbol	Conditions	Characteristic Values	
I_R	$V_R = V_{RRM}$ $T_{VJ} = 25^\circ\text{C}$	0.3	mA
		2.0	mA
V_F	$I_F = 150 \text{ A}$ $T_{VJ} = 25^\circ\text{C}$	1.7	V
V_{TO}	For power-loss calculations only	0.8	V
r_t		7.4	mΩ
R_{thJC}	per diode; 120° el.	7.50	K/W
	per module	1.25	K/W
R_{thJH}	per diode; 120° el.	8.40	K/W
	per module	1.40	K/W
d_S	Creeping distance on surface	12.7	mm
d_A	Creepage distance in air	9.4	mm
a	Max. allowable acceleration	50	m/s ²

Data according to IEC 60747 and refer to a single diode unless otherwise stated.

IXYS reserves the right to change limits, test conditions and dimensions.

20100920b

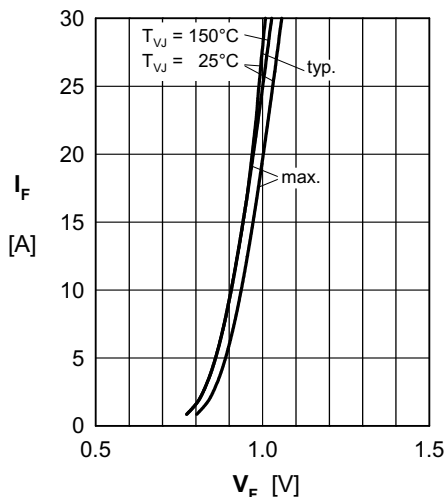

Fig. 1 Forward current versus voltage drop per diode

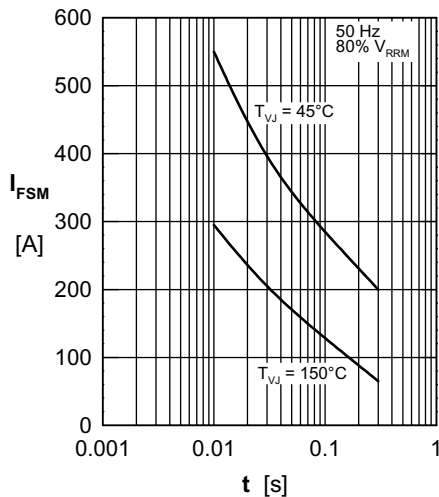

Fig. 2 Surge overload current per diode
I_{FSM}: Crest value. t: duration

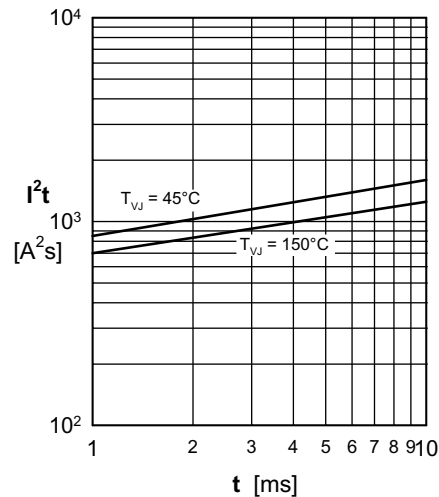

Fig. 3 I²t versus time (1-10 ms) per diode

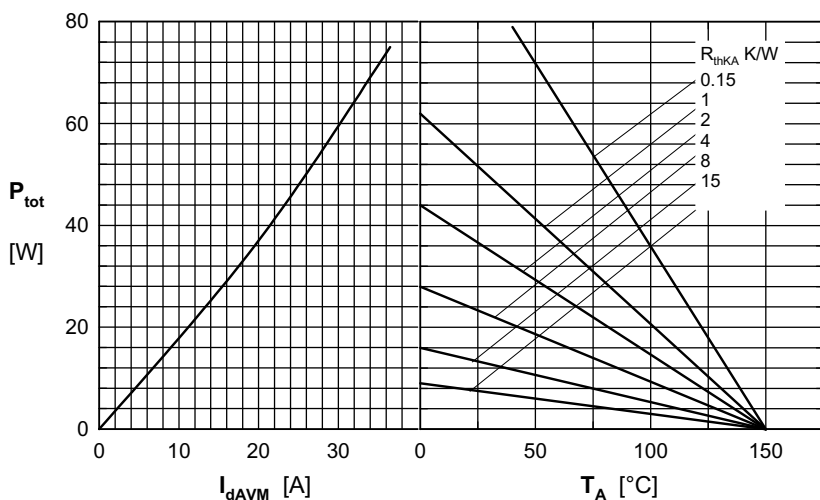

Fig. 4 Power dissipation vs. direct output current and ambient temperature

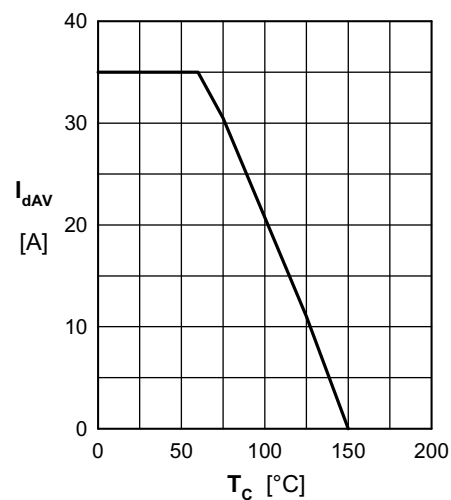

Fig. 5 Maximum forward current at case temperature

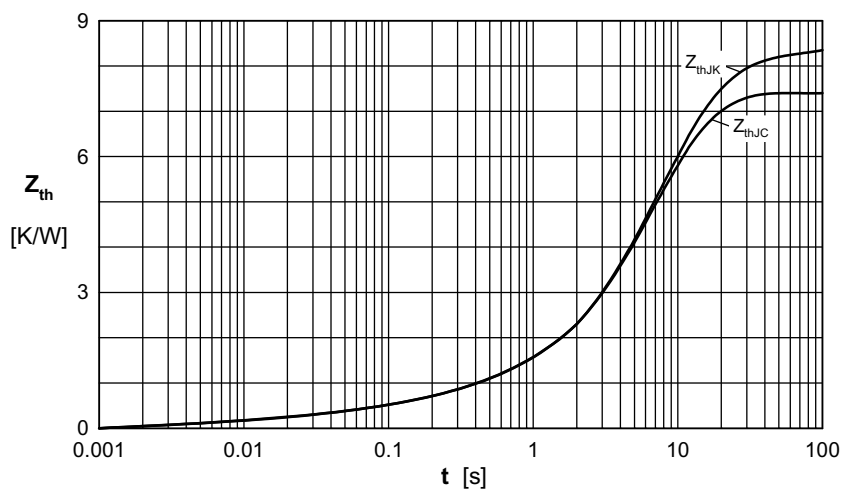

Fig. 6 Transient thermal impedance per diode

Constants for Z_{thJC} calculation:

i	R _{thi} (K/W)	t _i (s)
1	0.183	0.032
2	0.528	0.085
3	1.89	5.9
4	4.9	8.3

Constants for Z_{thJK} calculation:

i	R _{thi} (K/W)	t _i (s)
1	0.183	0.032
2	0.528	0.085
3	1.89	5.9
4	4.9	8.3
5	0.9	28