



»» Features

- 70A high power automotive relay.
- High temperature endurance up to 125 degree C.
- Optional to be equipped with protection diode or resistor.
- Dust cover version, flux free type, sealed & weather proof type or flange cover version to be chosen.
- Tinned terminal is available on request.
- Comply with RoHS-Directive 2002/95/EC, and ELV-Directive 2000/53/EC.

»» Type List

Terminal style	Contact form	Designation (provided with)	Enclosure style		
			Dust cover	Flux tight	Sealed type washable
Socket terminal	1A (SPNO)	-----	897-1AH-D	897-1AH-C	897-1AH-S
		Resistor	897-1AH-D-R1	897-1AH-C-R1	897-1AH-S-R1
PCB terminal	1A (SPNO)	-----	897P-1AH-D	897P-1AH-C	897P-1AH-S
		Resistor	897P-1AH-D-R1	897P-1AH-C-R1	897P-1AH-S-R1

Terminal style	Contact form	Designation (provided with)	Enclosure style	
			Flanged cover (dust cover)	Flanged cover (flux tight)
Socket terminal	1A (SPNO)	-----	897-1AH-D1	897-1AH-C1
		Resistor	897-1AH-D1-R1	897-1AH-C1-R1

Terminal style	Contact form	Designation (provided with)	Enclosure style	
			Steel bracket (dust cover)	Steel bracket (flux tight)
Socket terminal	1A (SPNO)	-----	897-1AH-D1S	897-1AH-C1S
		Resistor	897-1AH-D1S-R1	897-1AH-C1S-R1

Terminal style	Contact form	Designation (provided with)	Enclosure style	
			Steel bracket (dust cover with shroud)	Steel bracket (dust cover with weather proof)
Socket terminal	1A (SPNO)	Resistor	897-1AH-D1SF-R1	897-1AH-D1SW-R1

»» Ordering Information

897 P - 1AH - C - R1 - T 001
 1 2 3 4 5 6 7

- | | |
|---|--|
| <p>1. 897 -- Basic series designation</p> <p>2. Blank -- Socket terminal
P -- PCB terminal</p> <p>3. 1AH -- Single pole normally open, contact material AgSnO</p> | <p>4. D -- Dust cover
C -- Flux tight
S -- Sealed type washable
D1 -- Flanged cover (dust cover)
C1 -- Flanged cover (flux tight)
S1 -- Flanged cover (sealed type washable)
D1S -- Steel bracket (dust cover)</p> |
|---|--|

- | | | | | |
|------|--|----|-------|---|
| C1S | -- Steel bracket (flux tight) | 6. | Blank | -- Standard type |
| S1S | -- Steel bracket (sealed type washable) | | T | -- Special requirement for Tin plated terminal |
| D1SF | -- Steel bracket (dust cover with shroud) | 7. | Blank | -- Standard type |
| D1SW | -- Steel bracket (dust cover with weather proof) | | 001 | -- Coil parallel with diode IN4007 the positive pole"+"on # 85 terminal |
| 5. | Blank | | 002 | -- Coil parallel with diode IN4007 the negative pole"-on # 85 terminal |
| | R1 | | | -- Coil parallel with resistor 1/2W for 12V 680Ω , 24V 2700Ω |

»» Contact Rating

Max. Continuous current	70A 14VDC, 25A 28VDC
-------------------------	----------------------

»» Coil Rating (DC)

Rated voltage (V)	Rated current ±10 % at 23 °C (mA)	Coil resistance ±10 % at 23 °C (Ω)	Max. continuous Voltage at 85 °C ⁽¹⁾	Pick up voltage(Max) at 23 °C	Drop out voltage(Min) at 23 °C	Power consumption at rated voltage
12	133	90	100 % of rated voltage	65 % of rated voltage	10 % of rated voltage	approx. 1.6W
24	66.7	360				

Notes : (1) Continuous contact current at 50A.

»» Specification

Contact material	AgSnO alloy	
Contact voltage drop ⁽¹⁾	Typ. 30mV at 10A	
Insulation resistance ⁽¹⁾	20 MΩ Min. (DC 500V)	
Operate time ⁽¹⁾	20ms Max.	
Release time ⁽¹⁾	20ms Max.	
Dielectric strength ⁽¹⁾	Between open contact	: AC 500V , 50/60Hz 1 min.
	Between contact and coil	: AC 500V , 50/60Hz 1 min.
Vibration resistance	Operating extremes	10~55Hz , amplitude 2mm
	Shock resistance	
Life expectancy	Mechanical	10,000,000 operations (frequency 18,000 operations/hr)
	Electrical	100,000 operations (frequency 1,200 operations/hr)
Temperature range	Operating	-40~+125 °C (no freezing)
Weight	Approx. 40 g	

Note : (1) initial value

»» Outline Dimensions

◆ 897 (C,D,S)

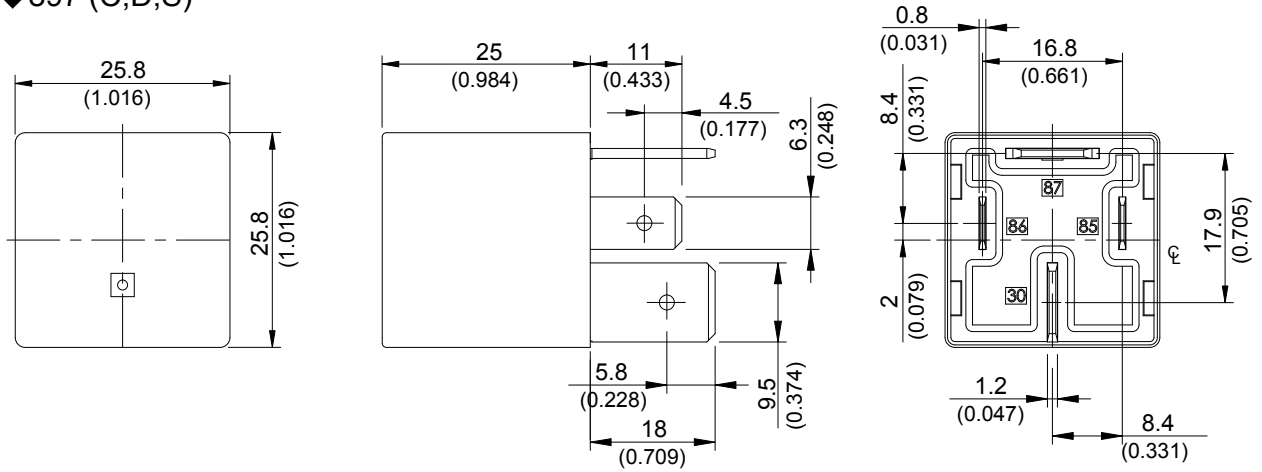

◆ 897 (C1,D1,S1)

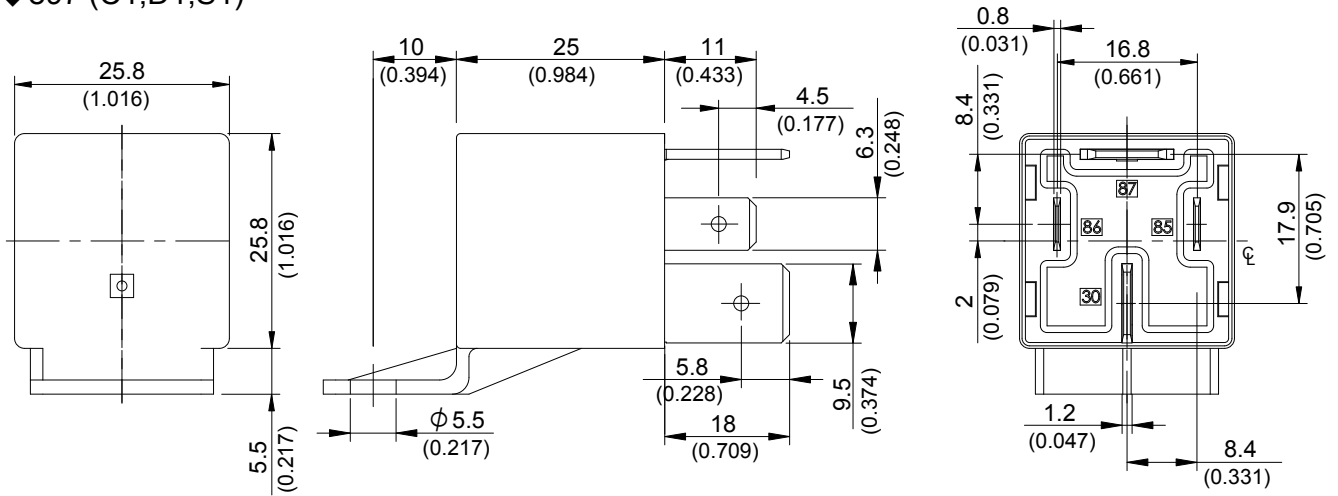

◆ 897 (C1S,D1S,S1S)

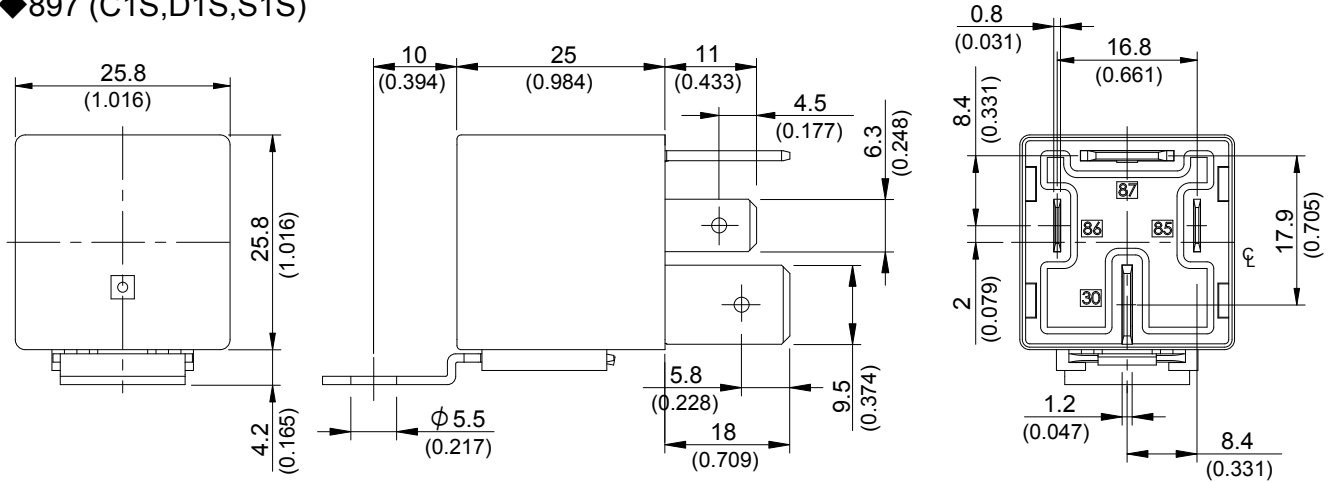

◆897 (D1SW)

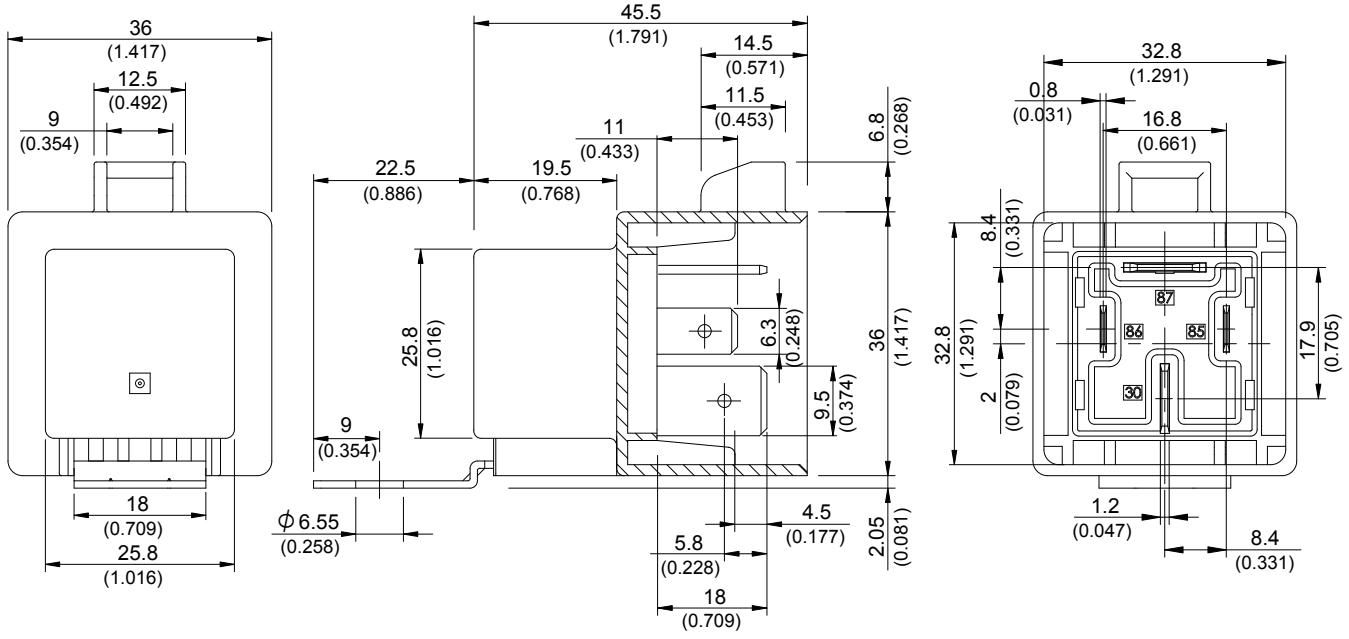

◆897 (D1SF)

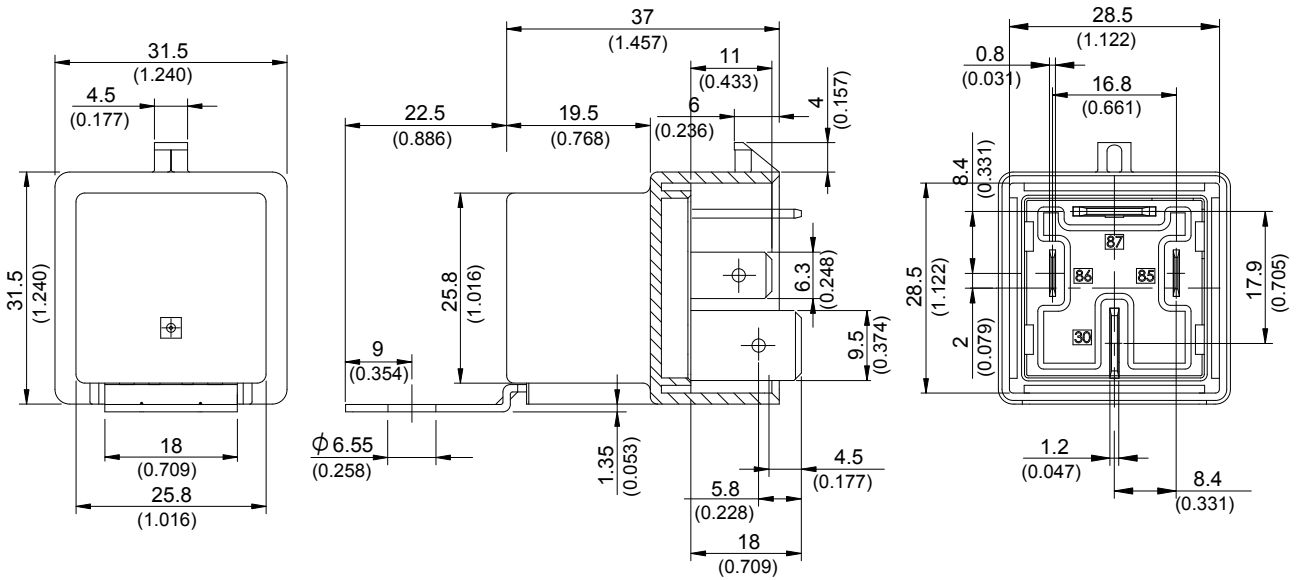

◆897P (C,D,S)

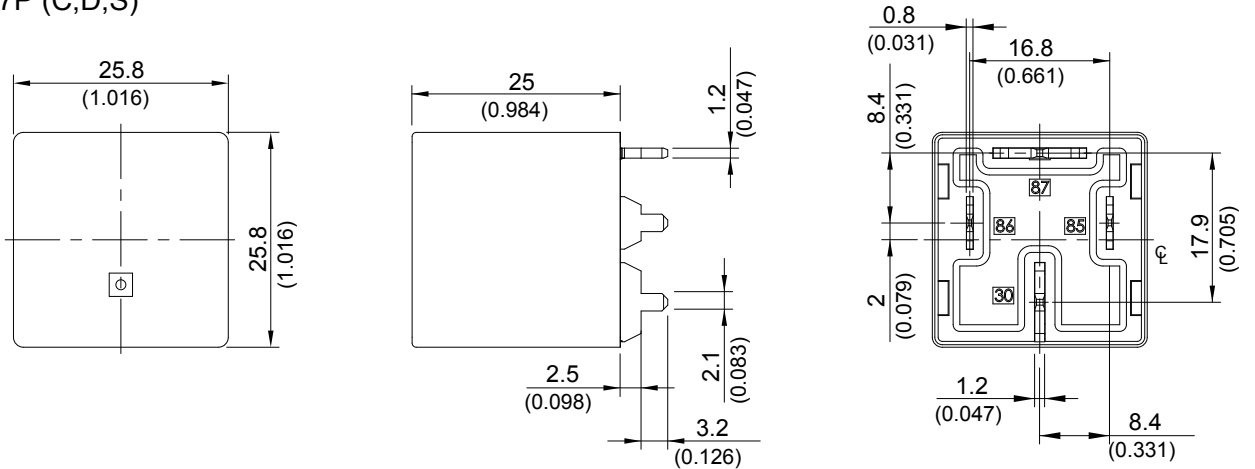

»»» Wiring Diagram

BOTTOM VIEW

1A

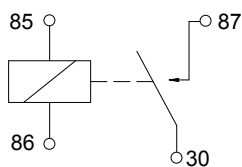

R1

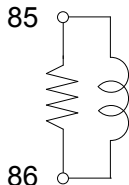

001

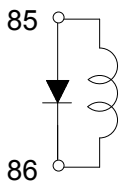

002

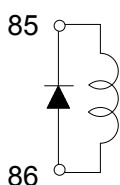

»»» PC Board Layout

BOTTOM VIEW

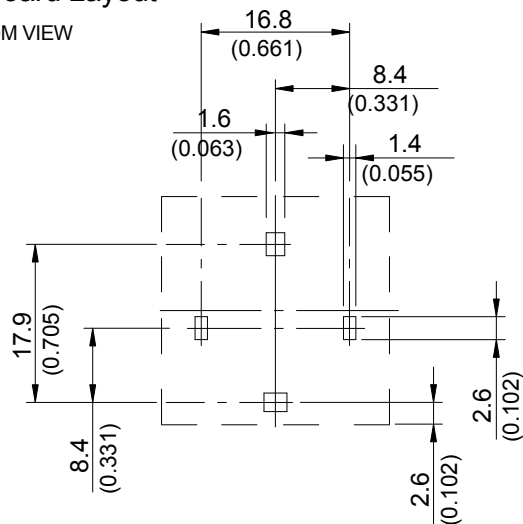

»»» Engineering Data

Safe breaking, arc extinguished
(normally open contact) for resistive loads.

