

DC-DC INVERTER SPECIFICATION

Model No. :8ACP1-8ZC2

Issue Date: 2010-05-03

1. Input:

- 1.1 Input Voltage: 12-15V DC
- 1.2 Output Voltage: 12-15V DC
- 1.3 Protection: Fuse 2A/250V
- 1.4 Input Inlet: Cigarette Lighter Plug
- 1.5 Cable length: 2.0M+/-10CM (in stretched)
260-280MM (in spiral)
- 1.6 Cable type: Black Round Cable in 3.4mm(2 x 14/0.12mm)

2. Environmental Requirements

- 2.1 Operating Temperature: 0 To 35
- 2.2 Storage Temperature: -20 To 60
- 2.3 Operating Humidity: 20%-85% Rh Non-Condensing
- 2.4 Storage Humidity: 100%-90% Rh Non-Condensing

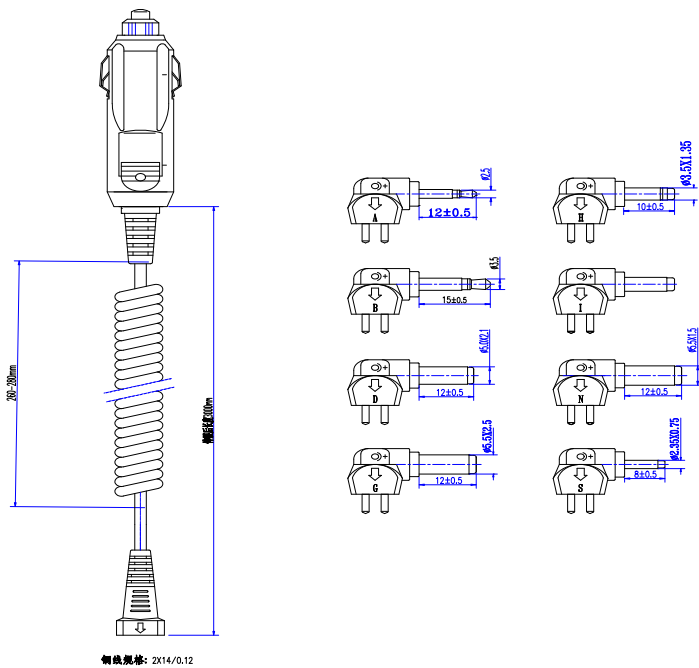

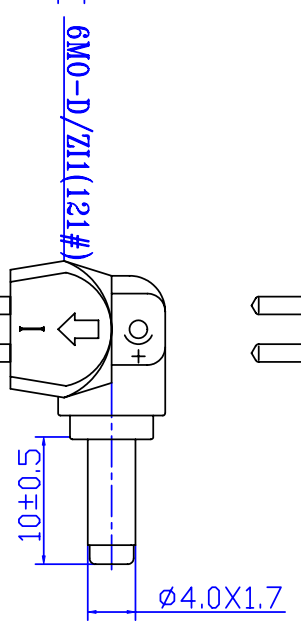
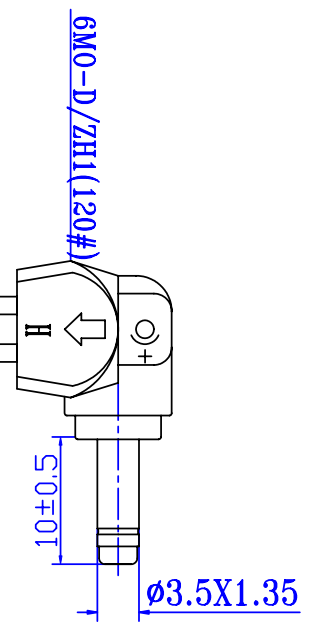
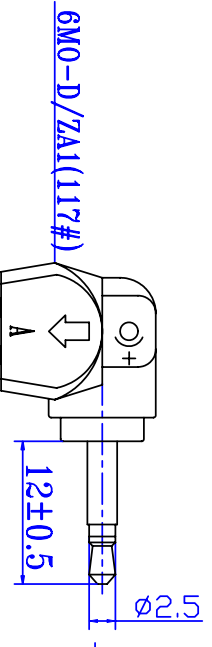
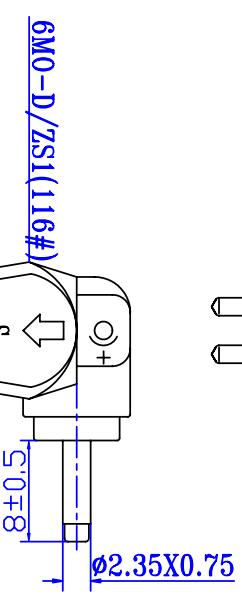
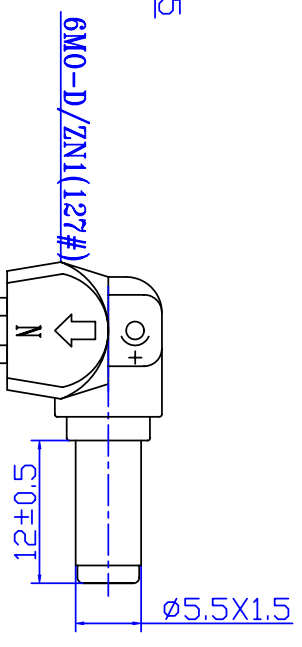
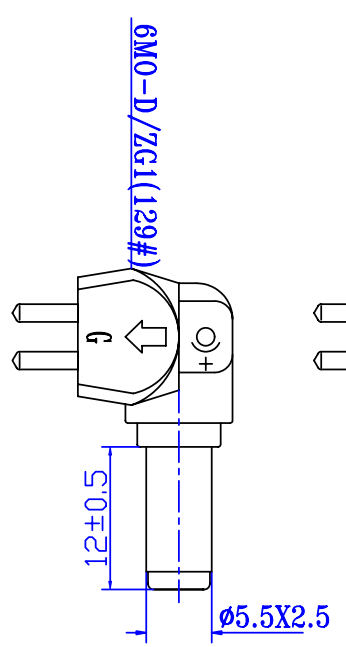
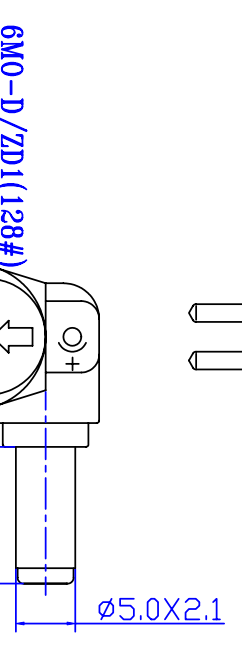
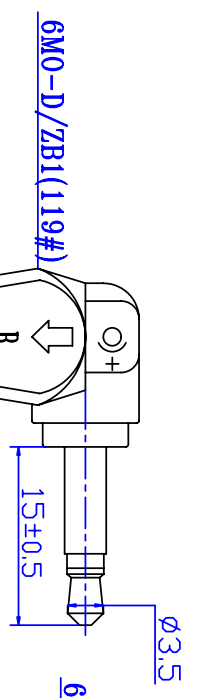
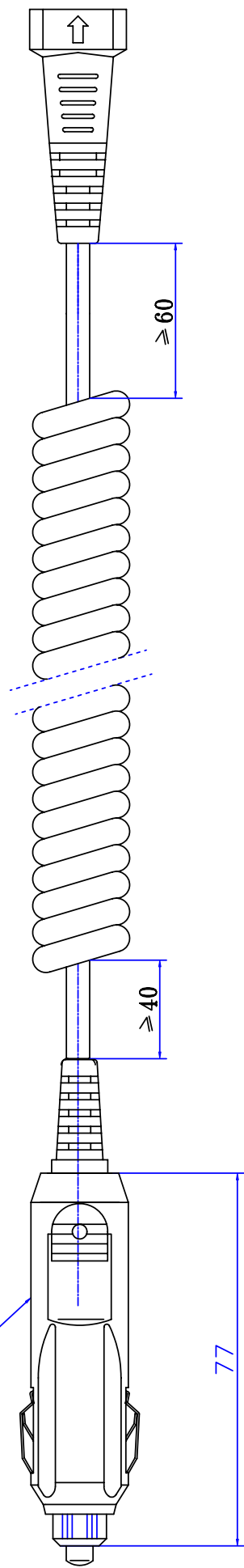

>
>