



USER MANUAL

(90010000 STANDARD)

ABOUT THIS USER MANUAL

This user manual is intended for end-users and installers of these receivers.

The purpose of this manual is to provide the user with all necessary information to ensure a correct, efficient and safe use of the product (during its lifetime), even in the event of a reasonably foreseeable misuse.

This manual is designed to facilitate the installation, commissioning, use, maintenance and disposal of the non-return modules.

This manual is intended to be carefully read by the user and should be completely understood, not leaving any uncertainties, before use and installation of the product.

INTRODUCTION

The product's purpose is to switch electric loads ON and / or OFF. The end user is able to switch a load ON and / or OFF by using a mobile iOS or Android App, which connects the smart device via wireless technology to the ICARUS blue receiver.

By touching the buttons in the main screen of the mobile app, the corresponding output will be activated or deactivated.

The product is designed to be used in systems with a voltage range from 9 - 36 Volts. The load of the whole system may never result in exceeding a total maximum current of 10 Amps.

The ICARUS blue receiver has an internal memory to store the app settings. When another user connects his / her smart device to the receiver, the saved settings will be loaded automatically.

CONTENTS OF THE PACKAGE

Please check the completeness of the box's contents:

- ICARUS blue device
- Connection cable
- Quick start guide

SYMBOL DESIGNATION



Attention / Danger



Product produced in accordance with EU directives.



Separate from waste processing after expiration of the service life.



Before use, read the user manual.

SAFETY REGULATIONS

General

The user should have read this user manual before using the device for the first time and its content should have been understood. If there are questions and / or uncertainties before the first use, you need to contact your supplier for clarification.

This user manual must also be included when this device is used by any third party.

Therefore:

- Losses incurred as a result of not going through the safety-requirements is not covered under warranty. We accept no liability for any consequential damages.
- We have no liability for property damage or personal injury caused by improper use or non-compliance with safety regulations. In such cases, the warranty will expire.
- This product is not a toy and is NOT intended for use by children.
- **DO NOT** leave packaging material lying around. This can be hazardous material for children.
- **DO NOT** open and / or disassemble and / or alter the device. This will expire the warranty.
- **DO NOT** put the device under mechanical pressure.
- The user must always comply with the safety and operating instructions, also from all other devices and / or applications associated with the product.
- When installing the device, make sure the cable is not crushed, kinked or damaged in any way, for instance by sharp edges.
- Consult an expert if you are unsure about the proper use, safety or connection of the device.

Operating

- Only use the device after having read the user manual thoroughly and having complete understanding, without any uncertainties, concerning the use and operation of the application where it is used in or for.
- **DO NOT** operate the device in an environment with lots of dust, flammable gases, vapours or solvents. This increases the risk of fire and explosions.
- When using and operating the app, the user must have complete overview of the work area.
- **DO NOT** use the device if it is damaged. In this case, discard the product in an environmental friendly manner.
- Safe operation is not possible anymore when :
 - The product has sustainable visible damage.
 - The product is operating poorly or not functioning at all.
 - Smoke, burning smell, discoloration of the product.

Power supply

- Only use the product within a range of 9 to 36 Volt dc.

Overload

- Make sure the product is neither mechanically nor electrically overloaded. This may damage the device and cause fire or electric shock.

TABLE OF CONTENTS

1. Technical specifications	4
2. Product type identification	4
3. The product's purpose (and usability)	5
4. ICARUS blue receiver	5
4.1 Installation requirements	6
4.2 Cable connections	7
4.3 Status LED	8
4.4 Activate / Deactivate Pairing Mode (Teach-In Button)	9
5. ICARUS blue app	9
5.1 Overview / Home screen	10
5.2 Adding a new receiver	11
5.3 Switching between several receivers	12
5.4 Mainfunctions	13
5.5 Advanced output options	14
5.5.1 Timer functions	14
5.5.2 Output control (Interlock)	15
5.5.3 Output selection and button-visibility	15
5.6 App flowchart	16
5.7 App-settings	17
5.7.1 Restore factory settings	17
5.7.2 Set password	17
5.7.3 Battery settings	17
6. Using the device	18
7. Maintenance and cleaning	18
8. Solving of DTC's (Diagnostic Trouble Codes)	18
9. Disposal	19
10. Warranty	19
11. Declaration of conformity	20

1. TECHNICAL SPECIFICATIONS

Frequency	2,4 GHz
Transmission power	7,5 dBm
Operating range	approximately 30m
Power consumption	~4mA on 12V
Supply voltage	9-36 Vdc
Outputs	4 (3.7A, nominal 4.7A each)
Total current	max. 10A
Dimensions	79mmx 87mm x 26mm (L x W x H)
Weight	138g
Casing	moulded casing (IP66)
Temperature range	-40°C to +80°C
Optical feedback	Dual colour LED (red / green)
Platform	Android and iOS
Max. number of paired devices	24
Min. system requirements	Android 4.3 and Bluetooth 4.0 iOS 8, iPhone 4s / iPad, 3rd gen. / iPod Touch, 5th gen.

2. PRODUCT TYPE IDENTIFICATION

Each ICARUS blue receiver is labelled (on the rear side) with a sticker containing the product name icon, a QR-code having an unique production / serial number, the product type identification, the supply current and some symbol designations.

An example of a device label is given below.

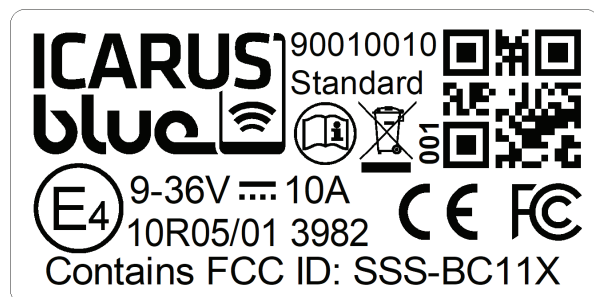

3. THE PRODUCT'S PURPOSE (AND USABILITY)

ICARUS blue is an app-controlled wireless receiver, with impressive features such as a compact and sturdy design, a legion of universal application possibilities and a low purchase price.

In conjunction with the free „ICARUS blue“ app (for Android and iOS), the user is able to control a maximum of four separate outputs (per ICARUS blue receiver) from a mobile smart device and configure them in different ways

Whether it comes to the control of winches, gates, dumper truck covers, doors, lighting, extending and slide-in systems, various hydraulic applications or electric motors of any kind - there is almost no limit to your ideas as long as used within the boundaries of the system specifications.

4. ICARUS BLUE RECEIVER

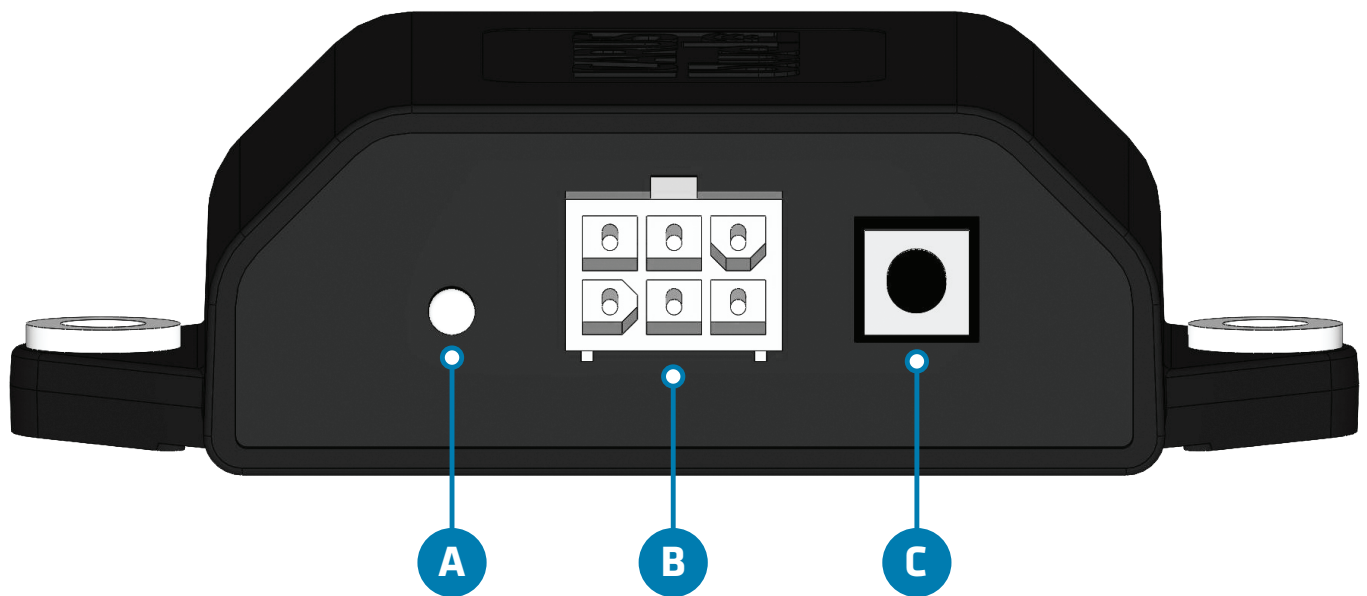

- A STATUS LED:** Displays the status of the receiver.
- B CONNECTION PLUG:** Connections for power supply and outputs.
- C TEACH-IN BUTTON:** Sets the receiver into pairing-mode (see 4.4).

4.1 INSTALLATION REQUIREMENTS

- Always make sure you are using a clean, tidy and dry working surface.
- Unplug the ICARUS blue receiver before installation and assembly from a connected power source.
- Install the ICARUS blue receiver in sight of the user, if possible.
- **DO NOT** install the ICARUS blue receiver in the immediate vicinity of motors, relays or power cables.
- **DO NOT** install the ICARUS blue receiver on the inside of a metal casing (this limits the connection range).
- Always complete a supplied wiring diagram before use.
- Use sufficiently thick and proper insulated cables for the conditions where it is used in or for.
- Interconnect the wires with proper cable connectors, and **DO NOT** only use insulation-tape for this purpose. Improper connections can cause fire and / or electric shock and lead to personal injuries and may damage the product.
- The ICARUS blue receiver has to be fixed with two screws / bolts (use M5 and length at will).
- Always comply with the applicable safety regulations.
- Install the ICARUS blue receiver with the connector facing down for max. water resistance!

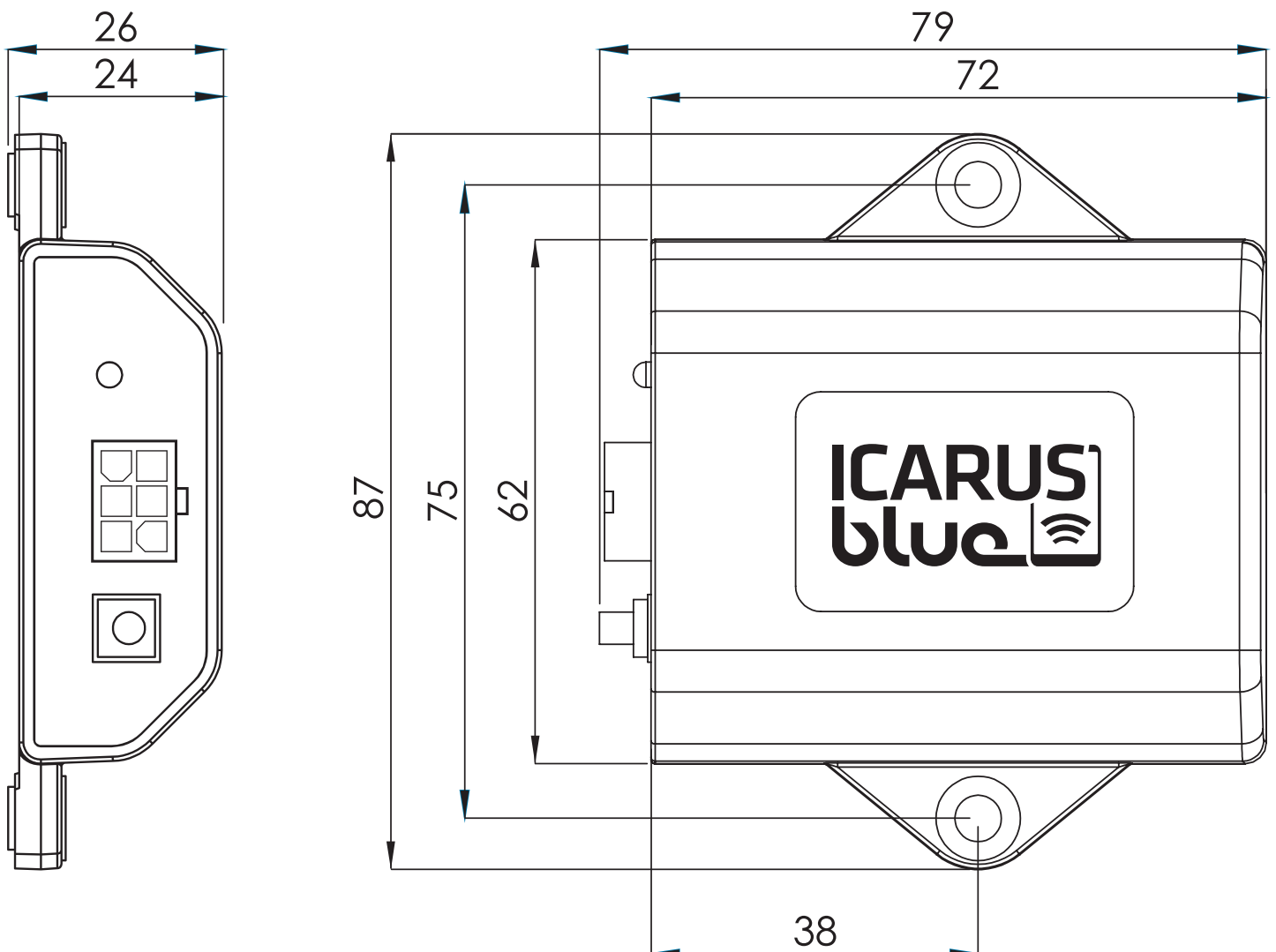

4.2 CABLE CONNECTIONS

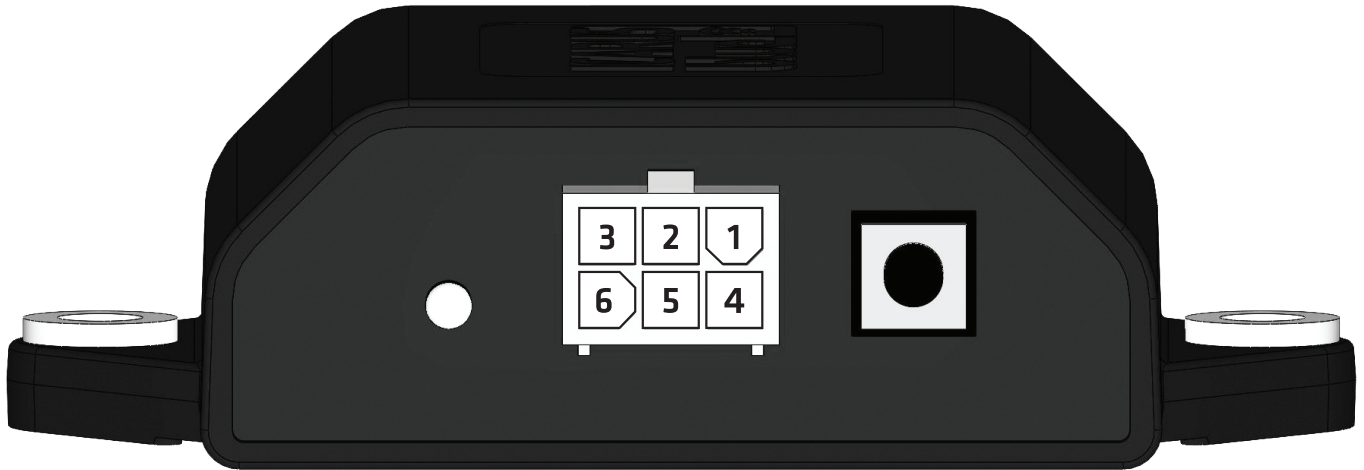

Function	Pin	Wire-Colour
0Vdc	4	Black
9-36V	1	Red
Output 1	2	Green
Output 2	5	Yellow
Output 3	3	Purple
Output 4	6	Grey

4.3 STATUS LED

„Start-up“ mode



„Not connected“ mode



„Connected“ mode



„Pairing“ mode



Example:

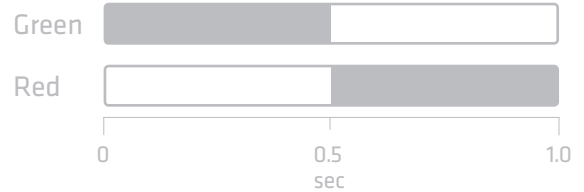

Explanation

 = ON  = OFF

For the above example this means:
Green light **ON** for 0.5 seconds while red light is off
-> Green light turns **OFF** while red light turns **ON**
for 0.5 seconds.

Error codes

Example three times:



Blinking	Description
3 x	Undervoltage (<6,5V for 1,5s)
4 x	Overvoltage (>36V for 60ms)
5 x	Sum of separate currents too high (>10A; e.g. short circuit)
6 x	Overcurrent output 1
7 x	Overcurrent output 2
8 x	Overcurrent output 3
9 x	Overcurrent output 4

-> Please see chapter 8 of this manual to solve the errors!

4.4 ACTIVATE/DEACTIVATE PAIRING MODE (TEACH-IN BUTTON)

The teach-in button of the ICARUS blue receiver is intended to activate the pairing functionality of the receiver.

- STEP 1** Please connect the supplied cable to the receiver. Please use exclusively the provided plug!
- STEP 2** Provide the receiver with power. Red cable = 9-36Vdc, Black cable = 0Vdc (see 4.2)
- STEP 3** Connect the cables (green, yellow, purple, grey) to the respective devices, that you want to control with your smartphone (see 4.2).
- STEP 4** Please press the teach-in button of the receiver three times within 4 seconds.
- STEP 5** The LED on the receiver flashes green. Wait a moment until the LED alternates between red and green.
- STEP 6** The pairing-mode of the receiver is now activated. Continue by pairing the receiver with your smartphone (see 5.2) or deactivate the pairing-mode, by pressing the teach-in button once more.

5. ICARUS BLUE APP

Please make sure, that your device (whether iOS or Android) meets the min. requirements as defined in chapter 1. Otherwise you won't be able to download the app and/or it won't work properly on your device.

Android

- Search for „Icarus Blue“ (by ICP Group) in the Google Play Store to find the app
- Download and install the app on your Android smartphone or tablet.

iOS

- Search for „Icarus Blue“ (by ICP Group) in the Apple App Store to find the app.
- Download and install the app on your iOS smartphone or tablet.

After installation

Please start the app. At first you'll be prompted to turn on the „Bluetooth“-function of your smartphone, if it is not already enabled. After that, you're asked to accept the general terms of usage.

If no ICARUS blue receivers have been paired to the device before, the app will show a short instruction for new users.

Please follow the In-App-Instructions to teach-in a new receiver on the device, or see 5.2 of this user manual!

5.1 OVERVIEW / HOME SCREEN

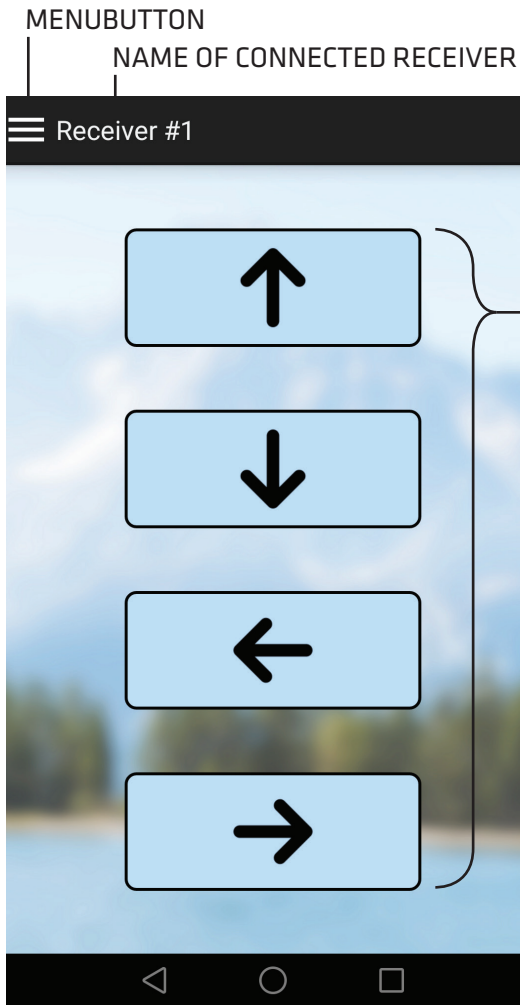

CONTROL BUTTONS

Possible button-statuses:



REGULAR

- Button is NOT pressed/touched
- Output is NOT active



BOLD BORDER

- Button is pressed/touched
- Output is NOT active



DARK BACKGROUND

- Button is NOT pressed/touched
- Output is active



BOLD BORDER AND DARK BACKGROUND

- Button is pressed/touched
- Output is active

5.2 ADDING A NEW RECEIVER

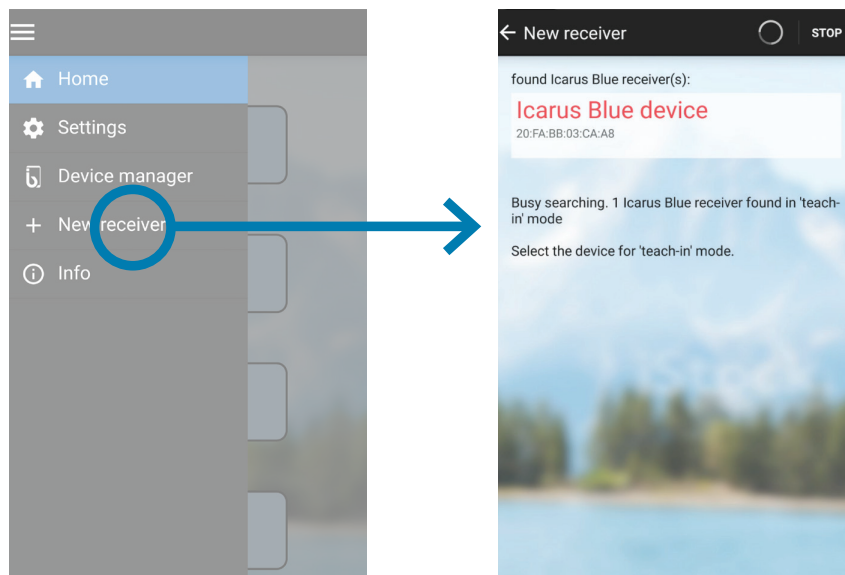

ATTENTION:

To add a new receiver, the receiver must be in „pairing-mode“ (see 4.4).
Please make sure that there is no more than one receiver in „pairing-mode“ at the same time.

- STEP 1** Open the main menu via the button at the top left and select the menu item „New receiver“.
- STEP 2** The app will automatically search for ICARUS blue receivers within your range, that are currently in „pairing mode“ (see 4.4).
- STEP 3** Select the receiver you want to connect, by pressing the corresponding entry of the search results.
- STEP 4** You'll now be prompted to enter a description/name for the receiver. Please confirm your choice by pressing the „Teach-in“ button.
- STEP 5** Your smartphone now connects to the selected ICARUS blue receiver and synchronises the settings.
- STEP 6** You are now able to control and/or configure your ICARUS blue receiver (see e.g. 5.4).

5.3 SWITCHING BETWEEN SEVERAL RECEIVERS

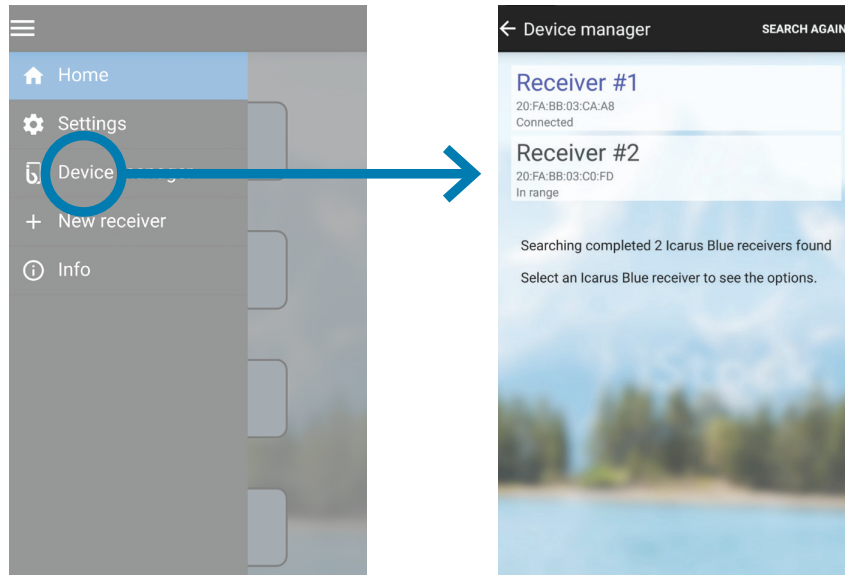

This step-by-step instruction assumes, that you have already paired two or more ICARUS blue receivers to your smartphone. If this is not the case, you first have to add additional ICARUS blue receivers (see 5.2).

- STEP 1** Open the main menu via the button at the top left and select the menu item „Device manager“.
- STEP 2** You'll now see a list of all receivers, that have already been paired with your smartphone in the past.
- STEP 3** Select the receiver you want to connect, by pressing the corresponding entry of the list.
- STEP 4** You can now decide whether to „Connect“, „Disconnect“, „Rename“ or „Remove“ the respective receiver.
- STEP 5** Please select „Connect“ and confirm your choice by pressing the „Next“ button.
- STEP 6** Your smartphone now automatically connects to the selected ICARUS blue receiver.
- STEP 7** You are now able to control and/or configure the chosen ICARUS blue receiver (see e.g. 5.4).

ATTENTION:

If you have previously been connected to another ICARUS blue receiver, this connection will be automatically disconnected and any processes / commands that may be running will be aborted, as soon as you connect to another receiver.

5.4 MAINFUNCTIONS

Once you have paired and connected a receiver to your smart device, you can control and configure the buttons / outputs as you wish with the ICARUS blue app. Please open the main menu of the app (top left corner) and select the „settings“ menu item.

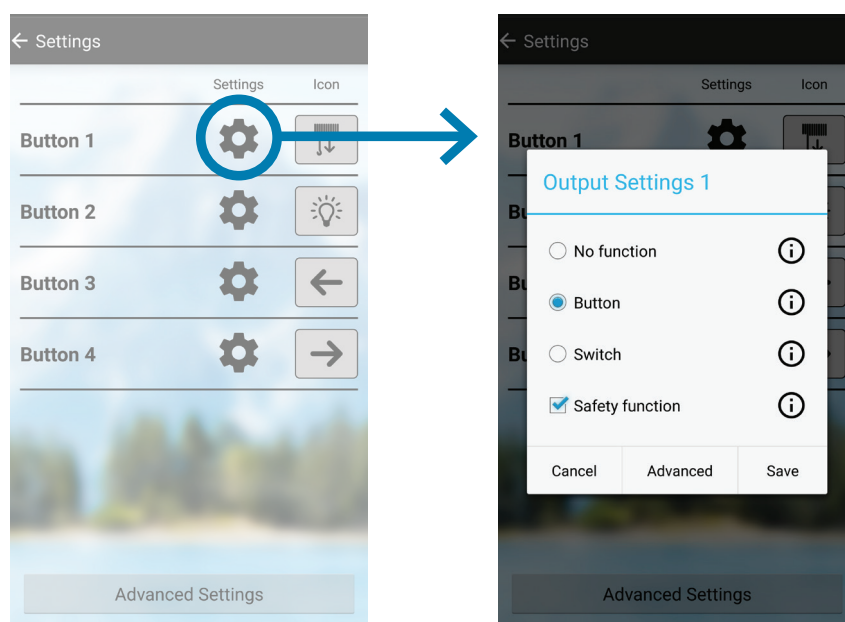

By pressing the „gear wheel“-icon of the respective button, you will get the following four basic setting options:

„No Function“

When this option is selected, the associated screen button is disabled and does not appear on the main screen.

„Button“

When this option is selected, the associated screen button operates as a push button. When the screen button is pressed, the output remains active. If the screen button is released, the output is deactivated.

„Switch“

When this option is selected, the associated screen button operates as a switch. When the screen button is pressed, the output is activated and remains on until the screen button is pressed again.

„Safety function“

If an output is switched on with the safety function activated, the corresponding output of the ICARUS blue receiver is turned off after the app has lost focus or the wireless connection is interrupted. If you deactivate this check box, the associated output of the ICARUS blue receiver remains active under all circumstances. Thus, the selected screen button/output can not perform any safety-relevant functions.

-> After selecting one of the above options, please press the „save“-button or proceed with 5.5 of this manual.

For further details and a step-by-step explanation of the respective functions, simply press the „i“-icon behind each function or take a look at our „How-to“-Videos on www.icarus-blue.com

5.5 ADVANCED OUTPUT OPTIONS

5.5.1 TIMER FUNCTIONS

The ICARUS blue app offers a variety of advanced options for every button / output.

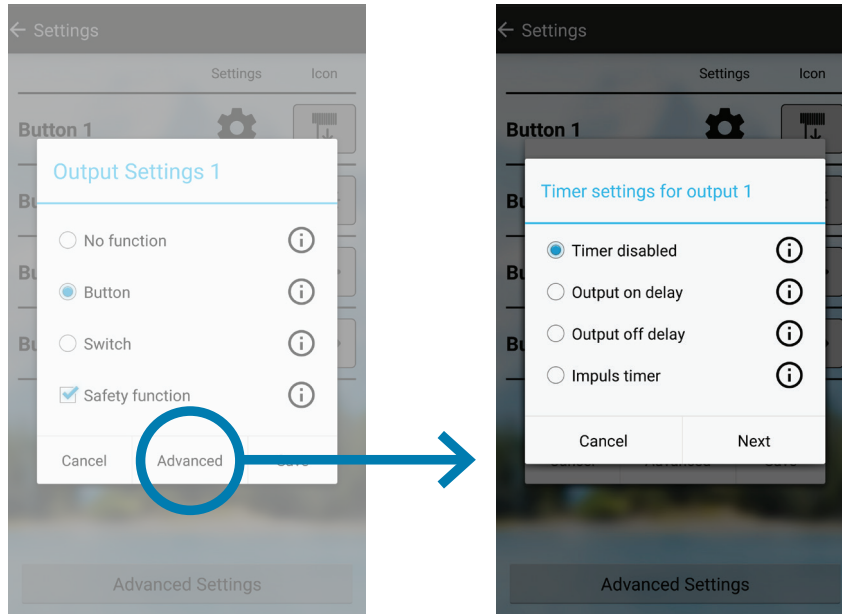

By pressing the „Advanced“-button in the „Output Settings“-screen, you will get the following options:

Timer disabled (selected by default): If this option is activated, the output has no timer function.

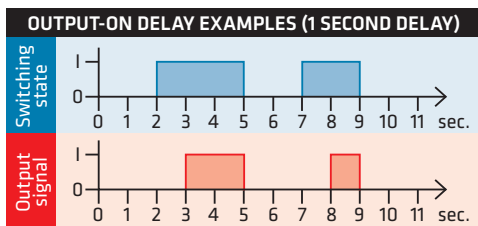

Output-On delay:

If this option is activated, the output turns on after the chosen time value. You can choose between hours, minutes, seconds and milliseconds.

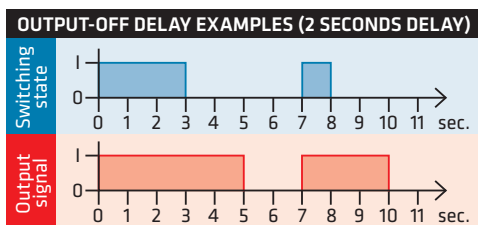

Output-Off delay:

If this option is activated, the output turns off after the chosen time value. Here you can choose between hours, minutes, seconds and milliseconds.

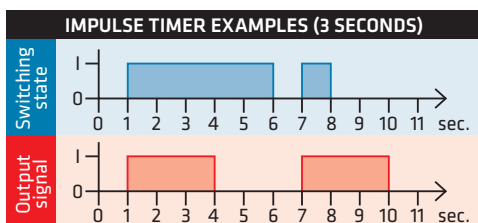

Impulse timer:

If this option is activated, the output is on only during the chosen time value. Here you can choose between hours, minutes, seconds and milliseconds.

Please proceed with 5.5.2.

5.5.2 OUTPUT CONTROL (INTERLOCK)

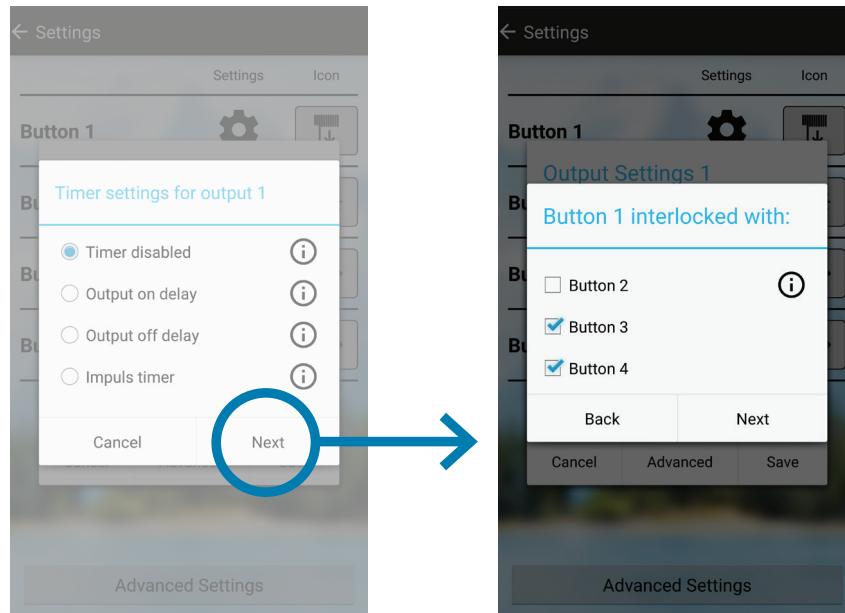

Setting an interlock between two or more buttons will prevent the outputs from being active at the same time.
Please proceed with 5.5.3

5.5.3 OUTPUT SELECTION AND BUTTON-VISIBILITY

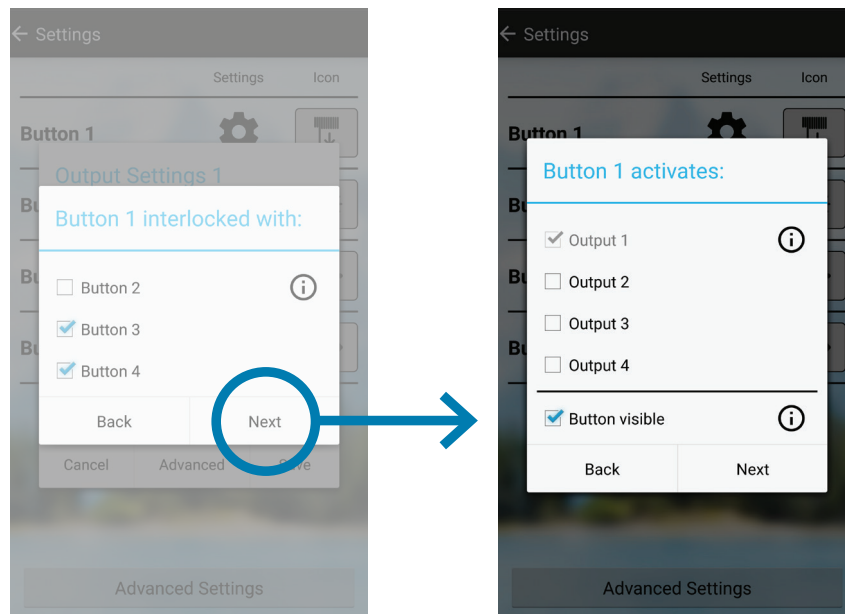

The selected outputs are activated if button is pressed.
You have the choice to make the Button of the additional output visible or not.
Note: Timer or other settings can influence the output.
Please press „Next“ and then „Save“ to confirm all changes.

5.6 APP FLOWCHART

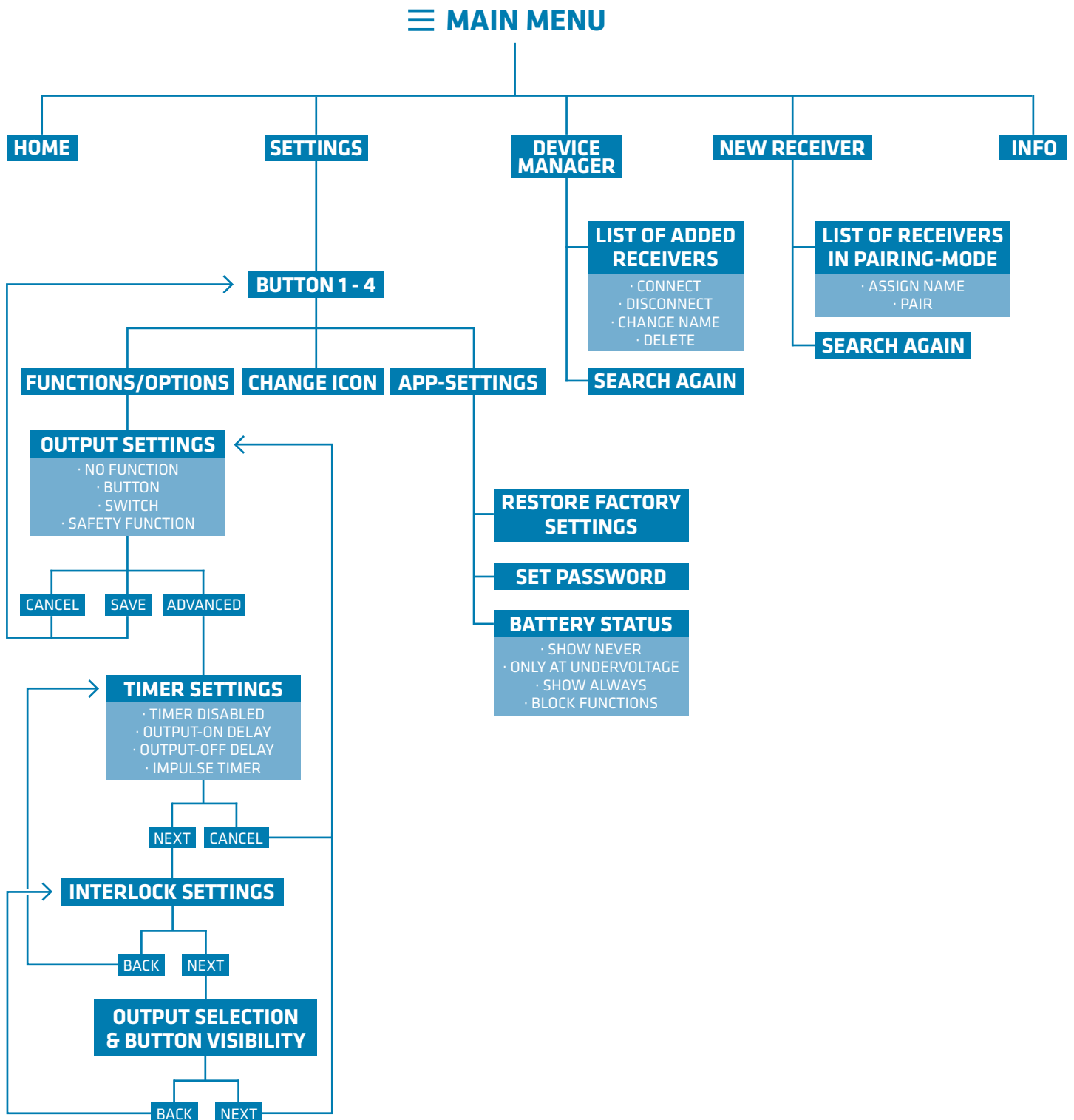

5.7 APP-SETTINGS

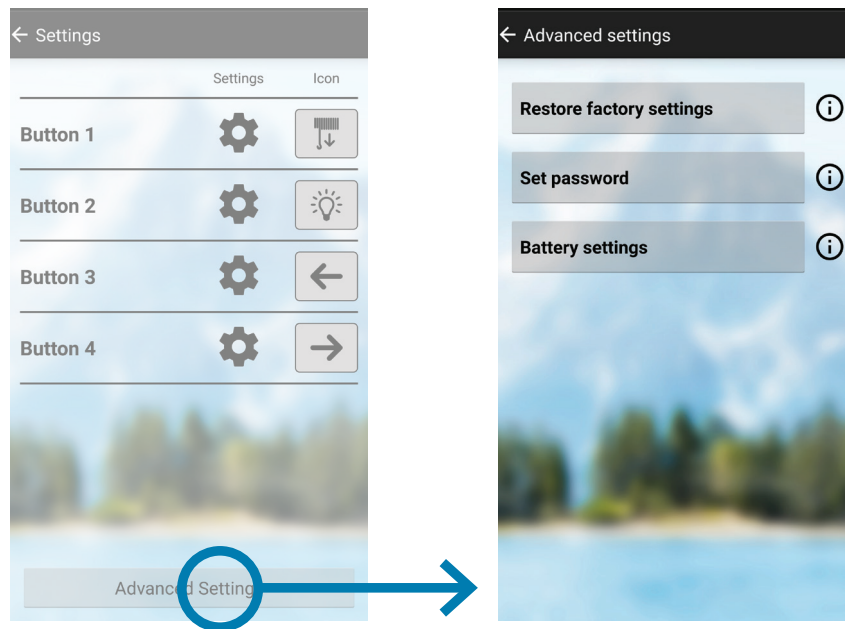

To get to the app-settings, first open the main menu on the top left and then select the menu item „Settings“.
On the lower edge of the following screen please press the „App-Settings“ button.
In the App-Settings you have the following options:

5.7.1 Restore factory settings

This option will reset all output functions to default.

5.7.2 Set password

If a password is entered, the output settings are password protected. This means, that changing the settings is only possible after entering the correct password. To remove the password, leave the new password empty/blank.

5.7.3 Battery settings

Enabling the battery status will show the actual system voltage in the home screen (top right corner). You can also decide to set some additional options, to e.g. prevent the system against undervoltage. The options are:

Show never -> The battery voltage will never be shown in the home screen.

Only at undervoltage -> The battery voltage is only shown when the voltage drops below the given undervoltage level.

Show always -> The battery voltage is always shown in the home screen.

Define undervoltage -> With this setting an undervoltage level can be set.

Block functions -> If the battery voltage drops below the defined undervoltage level (see above), all safe outputs are switched off (no matter if the output has a „timer function“ activated or not) and the screen buttons are blocked.
Attention: This function only works if the „safety function“ (see 5.4) is activated. Unsafe outputs won't be blocked!

After changing any of the above options, please press the „save“-button.

6. USING THE DEVICE

Improper operation, by NOT having read the user manual and having full understanding of it as well as how to use the device, can bring the operator, bystanders and other matters in danger, depending on its application, and may cause personal injury and / or damage to personal possessions as well as to the device.

7. MAINTENANCE AND CLEANING

The product is maintenance-free for the user. Maintenance and repairs must be done by a specialist. The device should be cleaned only with a damp cloth and without chemicals. Doing otherwise may damage the product.

8. SOLVING OF DTCs (DIAGNOSTIC TROUBLE CODES)

For a detailed illustration of the DTCs, please see 4.3!

Blinking 3x - Undervoltage

This error appears if the supply voltage of the receiver drops under 6,5V for at least 1,5sec. A pop-up will be shown in the ICARUS blue app. To reset the error raise up the supply voltage over 6,5V again and click on „reset error“ in the app.

Attention: Undervoltage can be triggered by heavy loads (large powerful motors).

Blinking 4x - Overvoltage

This error appears if the supply voltage of the receiver raises over 36V for at least 60ms. A pop-up will be shown in the ICARUS blue app. To reset the error lower the supply voltage under 32V again and click on „reset error“ in the app.

Attention: Overvoltage can be a result of defect components in the system or external voltage sources which are connected to the system (e.g. battery charger). Make sure that those sources are removed before resetting the error.

Blinking 5x - Overcurrent of all outputs combined

This error appears if the total current of the receiver is too high. To reset the error, a smartphone needs to be connected. After connecting, a pop-up will be shown in the ICARUS blue app and the error can be resetted by clicking on „reset error“. The error won't be resetted by a current drop.

Attention: Overcurrent can be a result of connecting to many loads to the receiver. Make sure those loads won't exceed a total maximum current of 10A.

Blinking 6x - 9x - Overcurrent of a single output

This error appears if the current of one of the outputs is too high. To reset the error, a smartphone needs to be connected. After connecting, a pop-up will be shown in the ICARUS blue app and the error can be resetted by clicking on „reset error“. The error won't be resetted if the current will drop down again.

Attention: Overcurrent of an output can be a result of connecting the output to a component which needs to much current. Make sure the current won't exceed the maximum current of 3,7A per output.

Overcurrent of an output can also be a result of a short circuit in the wiring. Make sure that all short circuits are removed before resetting the error.

9. DISPOSAL

Electronic devices are recyclable waste and DO NOT belong in the garbage. If the product does not work anymore, dispose it in accordance with applicable legal regulations.

By following the above recommendation you comply with your legal obligations and contribute to the protection of the environment.

10. WARRANTY

The ICARUS blue device has been tested in a controlled environment and proven to be resistant to moist and dust under certain conditions (meets the requirements of classification IP66 as described by the international standard IEC 60529)

It is not possible for the supplier / manufacturer to ensure that the contents of this user manual as well as the application of the products of the ICARUS Family will be understood and followed by the user. Improper and / or incorrect mounting and / or assembly and incorrect operation can result in personal injury and damage of the materials.

The manufacturer takes no responsibility for personal injury and damage of the materials and / or personal possessions, and any other arising costs, which are the result of improper and / or incorrect assembly, injudicious and improper use and / or incorrect application other than that for which our products are designed and manufactured, or the omission of maintenance or doing wrong maintenance, and / or anything else that is therewith linked, all of these completely at the discretion of the supplier / manufacturer.

Any unauthorized disassembly and / or alteration keeps the manufacturer from any responsibility. All necessary and used parts must be authorized by the manufacturer so the ICARUS blue will have and remain a guaranteed safety and operation over its lifetime.

11. DECLARATION OF CONFORMITY (ORIGINAL)

Manufacturer

ICP Systems B.V.
Handelsweg 48, 7451PJ Holten, The Netherlands.

Plant

ICP Systems B.V.
Handelsweg 48, 7451PJ Holten, The Netherlands.

Herewith declare that:

Product description : BT receiver
Product Name : ICARUS blue
Module Number : 90010000

are in conformity with provisions of the following directives and regulations:

Radio Equipment Directive (RED) 2014/53/EU
Low Voltage Directive (LVD) 2014/35/EU
Electromagnetic Compatibility (EMC) 2014/30/EU
UN ECE Regulation 10 Revision 5

and we comply with the following harmonized standards:

Safety EN 60950-1:2006/A2:2013
EMC EN 301 489-1 V1.9.2
EN 301 489-3 V1.9.2
EN 301 489-17 V1.9.2
EN61000-4-2
EN61000-4-3
EN61000-4-4
EN61000-4-6
EN61000-4-8
EN 62479:2010
Radio EN 300 328 V1.9.1

Year in which CE marking was first affixed : 2016

Issued by : ICP Systems B.V.
Date : August 1, 2017
Place : Holten, The Netherlands

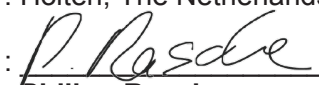
Signature : 
Philipp Rasche
ICP systems B.V.

