

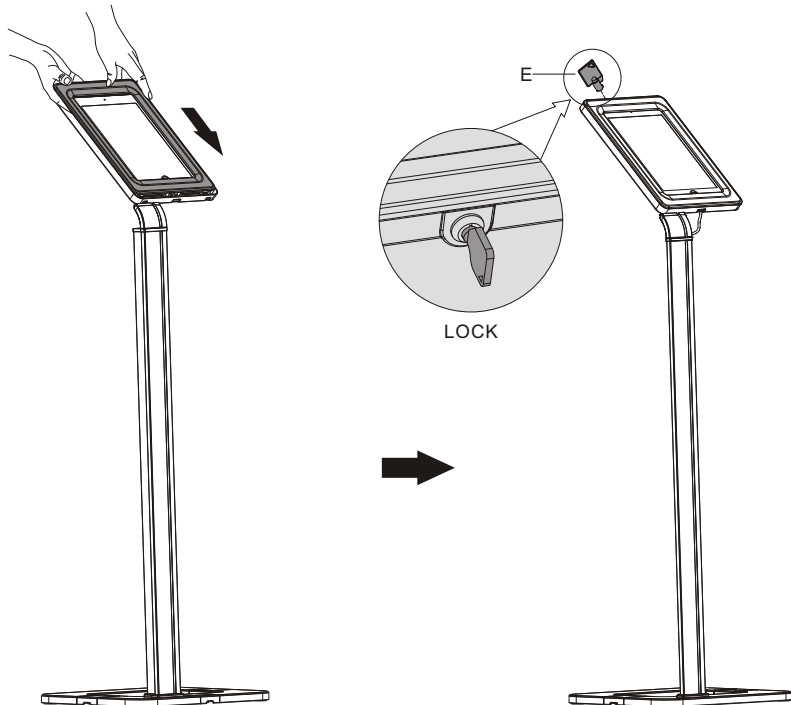

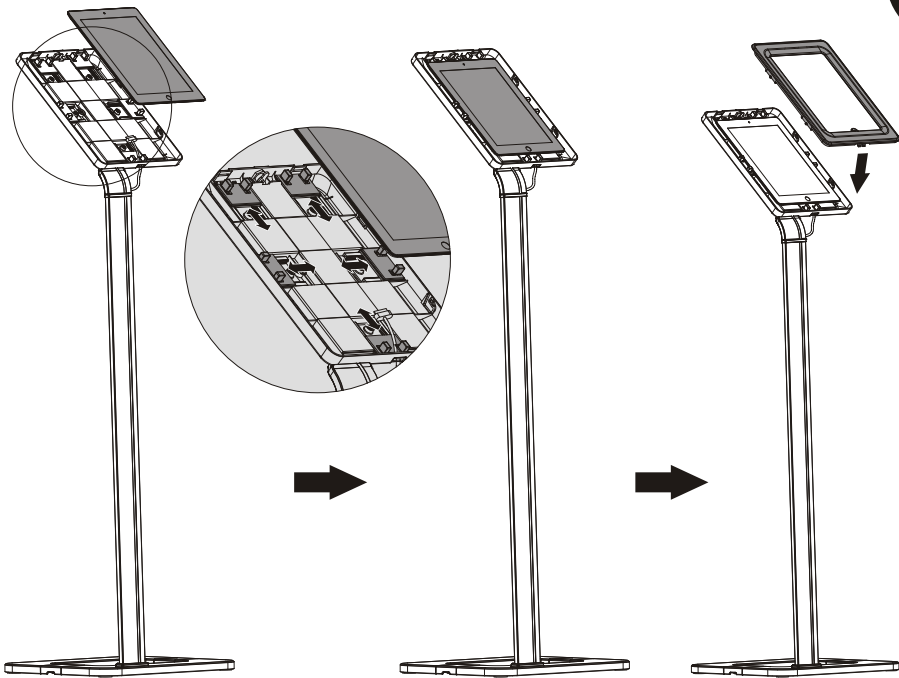











9



# PAD15-01/PAD15-02 Installation Instruction



| ITEM | DESCRIPTION/PART NO.   | QUANTITY | ITEM | DESCRIPTION/PART NO.  | QUANTITY |
|------|--|----------|------|---|----------|
| A    |  plastic case     | 1        | G    |  M6x16           | 4        |
| B    |  base             | 1        | H    |  M6x8            | 2        |
| C    |  pole             | 1        | I    |  M5x12           | 4        |
| D    |  bracket          | 1        | J    |  Concrete anchor | 3        |
| E    |  key              | 2        | K    |  5mm Allen key   | 1        |
| F    |  connecting piece | 1        | L    |  ST5.5x38        | 3        |
|      |  |          | M    |  D5 washer       | 3        |

