

Handle unit standard, without Fuse monitoring, for Size NH2, accessory for fuse switch disconnecter 3NP1



Versie

productmerknaam	SENTRON
uitvoering van het product	toebehoren voor mespatroonlastscheider 3NP1

Certificaten

General Product Approval

Declaration of Conformity

[Miscellaneous](#)



EG-Konf.

Verdere informatie

Information- and Downloadcenter (Catalogs, Brochures,...)

<http://www.siemens.com/lowvoltage/catalogs>

Industry Mall (Online ordering system)

<https://mall.industry.siemens.com/mall/nl/nl/Catalog/product?mlfb=3NP1953-1GA00>

Service&Support (Manuals, Certificates, Characteristics, FAQs,...)

<https://support.industry.siemens.com/cs/ww/nl/ps/3NP1953-1GA00>

Image database (product images, 2D dimension drawings, 3D models, device circuit diagrams, ...)

http://www.automation.siemens.com/bilddb/cax_en.aspx?mlfb=3NP1953-1GA00

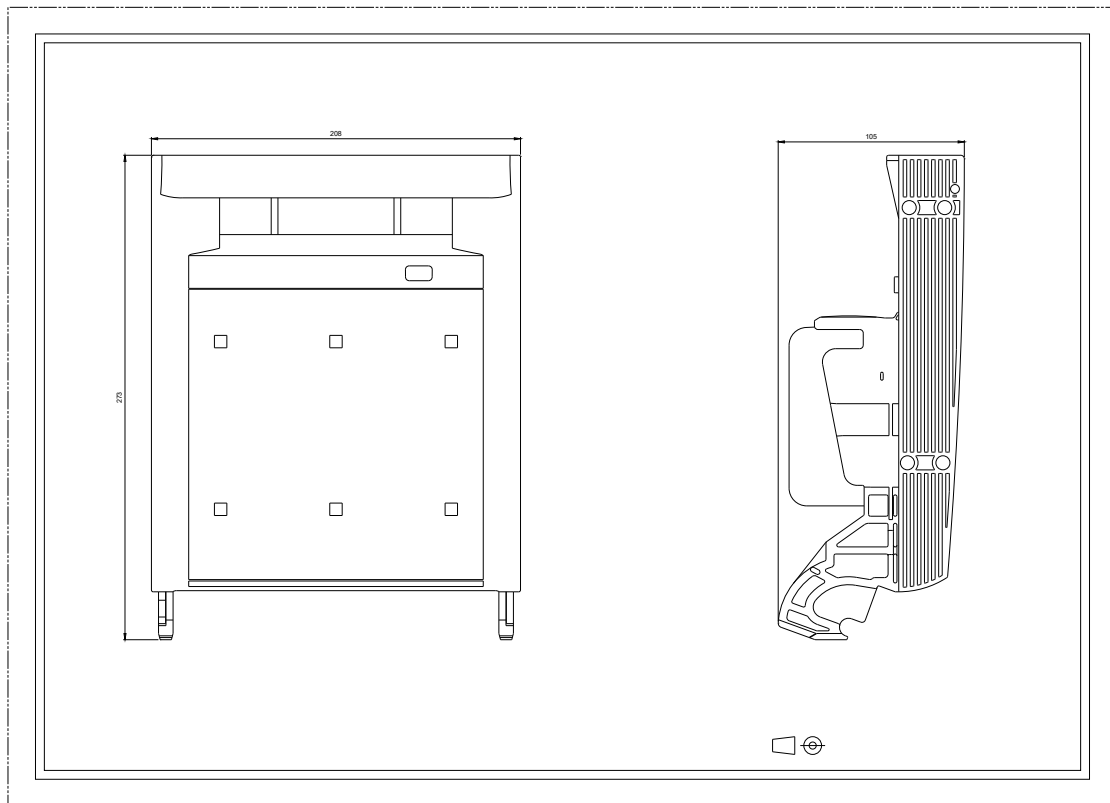



-CB

